



K S R Institute for Engineering and Technology

Tiruchengode, Namakkal(Dt) , Tamil Nadu

(Approved by AICTE New Delhi & Affiliated to Anna University Chennai)

BE (CSE,EEE,ECE,Mech)&B.Tech (IT) Programmes are Accredited by NBA

1.1.2 The Institution adheres to the Academic Calendar including for the conduct of CIE.

Table of Contents

S. No.	Details	Page No.
1.	University Academic Schedule	2 – 24
2.	Institute Academic Schedule	25 – 110
3.	University Internal Assessment Schedule	111 – 138
4.	Internal Assessment Circular	139 – 180
5.	Internal Assessment Duty Chart	181 – 202
6.	Internal Assessment Seating Arrangements	203– 226
7.	IAT Question Paper & Scheme	227 – 244
8.	CO Attainment	245 – 250

ANNA UNIVERSITY, CHENNAI
ACADEMIC SCHEDULE
 for the
August 2015 – December 2015 ODD SEMESTER ACADEMIC SESSION OF THE
ACADEMIC YEAR 2015 – 2016
I SEMESTER

UG (FT) Degree Programmes offered at Affiliated Engineering Colleges

Sl. No.	Programme	Semester	Commencement of Classes	Last working day	Commencement of End Semester Examinations
1.	B.E. / B.Tech. (Full Time)	I	03.08.2015	30.11.2015	07.12.2015
2.	B.Arch. (Full-Time)	I			

RE-OPENING DAY FOR THE NEXT SEMESTER: 04.01.2016 (Monday)

NOTE:

1. Theory and Practical Examination schedules will be published in due course. (Practical Examinations will be conducted before the theory examinations).
2. If necessary, loss of classes due to various curricular / co-curricular activities of the department / college may be compensated by conducting classes on Saturdays.

 PRINCIPAL
 K. S. R. KUMARASWAMY
 ENGINEERING COLLEGE FOR TECHNOLOGY,
 K. S. R. KUMARASWAMY NAGAR,
 TIRUCHENGODE-637 215,
 NAMAKKAL DISTRICT, TAMIL NADU.

 DIRECTOR
 ACADEMIC COURSES

ANNA UNIVERSITY: : CHENNAI – 600 025

ACADEMIC SCHEDULE

for the

February 2016 – May 2016 (EVEN SEMESTER) SESSION OF THE

ACADEMIC YEAR 2015 – 2016

UG & PG Degree Programmes offered in Affiliated Engineering Colleges

Sl. No.	Programme	Semester	Commencement of Classes	Last working day	Commencement of End Semester Examinations
1.	B.E. / B.Tech.(Full-Time)	VIII	30.01.2016	30.04.2016	02.05.2016
2.	B.E. / B.Tech.(Full-Time)	II,IV,VI	01.02.2016	07.05.2016	09.05.2016
3.	B.E. (Part-Time)	III,V,VII			
4.	B.Arch. (Full-Time)	II,IV,VI,VIII,X			
5.	M.E. / M.Tech./ M.Arch.(FT/PT)	II,IV,VI			
6.	M.C.A. (Full-Time)	II,IV,VI			
7.	M.B.A. (FT/PT)	II,IV,VI			
8.	M.Sc (5 Yrs-Integrated)	II,IV,VI,VIII,X			
9.	M.Sc.(2 Yrs)	II,IV			

RE - OPENING DAY FOR THE NEXT SEMESTER: 04.07.2016 (Monday)

NOTE:

1. The Theory and Practical Examination schedules will be published in the due course (Practical Examinations will be conducted before the theory examinations).
2. All Saturdays are working days.



DIRECTOR
ACADEMIC COURSES

DVC - 98



PRINCIPAL,
K. S. R. INSTITUTE FOR
ENGINEERING AND TECHNOLOGY,
K. S. B. ROAD, PONDICHERRY,
TIRUCHENGOORE-637 215,
NAMAKKAL DL, TAMIL NADU.

REVISED

ANNA UNIVERSITY, CHENNAI

ACADEMIC SCHEDULE

for the

**July 2016 – December 2016 ODD SEMESTER ACADEMIC SESSION OF THE
ACADEMIC YEAR 2016 – 2017**

UG & PG (Full-Time) Degree Programmes offered at Affiliated Engineering Colleges

Sl. No	Programme	Semester	Commencement of Classes	Last working day	Commencement of End Semester Examinations
1.	B.E. / B. Tech.(Full-Time)	III, V, VII	04.07.2016	26.10.2016	02.11.2016
2.	B. Arch.(Full-Time)	III, V, VII, IX			
3.	M.E. / M.Tech./ M. Arch. (FT/PT) (Except M.E. Structural Engg., M.E. Soil Mech. & Found Engg., M.E. Construction Engg. & Management M. Tech. Remote Sensing & M.E. Environmental. Engg.)(FT/PT)	III, V	18.07.2016	08.11.2016	14.11.2016
4.	M.Sc.(5 years) / M.Sc.(2 years) / B. Sc.	III, V, VII, IX			
5.	M.C.A. (Full-Time)	III, V			
6.	M.B.A. (Full-Time/Part-Time)	III, V	25.07.2016	15.11.2016	21.11.2016
7.	M.E. Structural Engg. (FT/PT) M.E. Soil Mech. & Foundation Engg. (FT/PT) M.E. Cons. Engg. & Management (FT/PT) M. Tech. Remote Sensing (FT) M.E. Environmental Engg. (FT/PT)	III, V			

RE-OPENING DAY FOR THE NEXT SEMESTER: 26.12.2016 (Monday)

1. Theory and Practical Examination schedules will be published in due course. (Practical Examinations will be conducted before the theory examinations).
2. If necessary, loss of classes due to various curricular / co-curricular activities of the department / college may be compensated by conducting classes on Saturdays.

DAC - SB



PRINCIPAL
K. S. R. INSTITUTE FOR
ENGINEERING AND TECHNOLOGY,
K. S. R. WALVI NAGAR,
TIRUCHENGODE-637 215,
NAMAKKAL Dt, TAMIL NADU.

DIRECTOR
ACADEMIC COURSES

ANNA UNIVERSITY, CHENNAI
ACADEMIC SCHEDULE
 for the
August 2016 – November 2016 ODD SEMESTER ACADEMIC SESSION OF THE
ACADEMIC YEAR 2016 – 2017
I SEMESTER

UG (FT) Degree Programmes offered at Affiliated Engineering Colleges

Sl. No.	Programme	Semester	Commencement of Classes	Last working day	Commencement of End Semester Examinations
1.	B.E. / B.Tech. (Full Time)	I	01.08.2016	22.11.2016	28.11.2016
2.	B.Arch. (Full-Time)	I			

RE-OPENING DAY FOR THE NEXT SEMESTER: 26.12.2016 (Monday)

NOTE:

1. Theory and Practical Examination schedules will be published in due course. (Practical Examinations will be conducted before the theory examinations).
2. If necessary, loss of classes due to various curricular / co-curricular activities of the department / college may be compensated by conducting classes on Saturdays.

 PRINCIPAL,
 K. S. R. INSTITUTE FOR
 ENGINEERING AND TECHNOLOGY,
 K. S. R. KALVI NAGAR,
 TIRUCHENGODE-637 215,
 NAMAKKAL DL TAMIL NADU.

 DIRECTOR
 ACADEMIC COURSES

DAC - SB



ANNA UNIVERSITY, CHENNAI
ACADEMIC SCHEDULE
 for the
August 2016 – December 2016 ODD SEMESTER ACADEMIC SESSION OF THE
ACADEMIC YEAR 2016 – 2017
I SEMESTER

PG (FT / PT) Degree Programmes offered at Affiliated Engineering Colleges

Sl. No	Programme	Semester	Commencement of Classes	Last working day	Commencement of End Semester Examinations
1.	M.E. / M. Tech. / M. Arch. / M.B.A. / M.C.A (FT/PT)	I	22.08.2016	13.12.2016	19.12.2016

RE-OPENING DAY FOR THE NEXT SEMESTER: 23.01.2017 (Monday)

NOTE:

1. Theory and Practical Examination schedules will be published in due course. (Practical Examinations will be conducted before the theory examinations).
2. If necessary, loss of classes due to various curricular / co-curricular activities of the department / college may be compensated by conducting classes on Saturdays.

 PRINCIPAL,
 K. S. R. INSTITUTE FOR
 ENGINEERING AND TECHNOLOGY,
 K S R PALVI NAGAR,
 TIRUCHENGODE-637 215,
 NAMAKKAL DL, TAMIL NADU.

 DIRECTOR
 ACADEMIC COURSES

ANNA UNIVERSITY : CHENNAI - 600 025

ACADEMIC SCHEDULE

for the

January 2017 - May 2017 (EVEN SEMESTER) SESSION OF THE
ACADEMIC YEAR 2016 - 2017UG & PG Degree Programmes offered in Affiliated Engineering Colleges

Sl. No.	Programme	Semester	Commencement of Classes	Last working day	Commencement of End Semester Examinations
1.	B.E. / B.Tech.(Full-Time)	VIII	04.01.2017	13.04.2017*	17.04.2017
2.	B.E. / B.Tech.(Full-Time)	II,IV,VI	04.01.2017	24.04.2017	27.04.2017
3.	B.E. (Part-Time)	III,V,VII			
4.	B.Arch. (Full-Time)	II,IV,V,VI,III,X			
5.	M.E. / M.Tech. / M.Arch.(FT)	II,IV			
6.	M.C.A. (Full-Time)	II,IV,VI	23.01.2017	05.05.2017**	10.05.2017
7.	M.B.A. (FT)	II,IV			
8.	M.Sc (5 Yrs-Integrated)	II,IV,VI,VIII,X			
9.	M.Sc.(2 Yrs)	II,IV			
10.	M.B.A. (5 Yrs-Integrated)	II			

RE - OPENING DAY FOR THE NEXT SEMESTER: 03.07.2017 (Monday)

*6 Saturdays are Working days

**4 Saturdays are Working days

NOTE:

1. The Theory and Practical Examination schedules will be published in the due course (Practical Examinations will be conducted before the theory examinations).
2. If necessary, loss of classes due to various curricular / co-curricular activities of the department / college may be compensated by conducting classes on Saturdays.

DIRECTOR
ACADEMIC COURSES

[Handwritten signature]

 PRINCIPAL,
 K S ENGINEERING FOR
 ENGINEERING TECHNOLOGY,
 BAGAR,
 TIRUCHENGODE-637 215,
 NAIKAKAL DI, TAMIL NADU.

ANNA UNIVERSITY, CHENNAI

ACADEMIC SCHEDULE

for the

July 2017 – December 2017 ODD SEMESTER ACADEMIC SESSION OF THE

ACADEMIC YEAR 2017 – 2018

UG & PG (Full-Time) Degree Programmes offered at Affiliated Engineering Colleges

Sl. No	Programme	Semester	Commencement of Classes	Last working day	Commencement of End Semester Examinations
1.	B.E. / B. Tech.(Full-Time)	III, V, VII	03.07.2017	21.10.2017	30.10.2017
2.	B.E. / B. Tech.(Part-Time)	III, V, VII			
3.	B. Arch.(Full-Time)	III, V, VII, IX			
4.	M.E. / M. Tech. / M. Arch. (FT)	III			
5.	M.Sc.(5 years)	III, V, VII, IX			
6.	M.C.A. (Full-Time)	III, V			
7.	M.B.A. (Full-Time)	III			

RE-OPENING DAY FOR THE NEXT SEMESTER: 18.12.2017 (Monday)

1. Theory and Practical Examination schedules will be published in due course. (Practical Examinations will be conducted before the theory examinations).
2. If necessary, loss of classes due to various curricular / co-curricular activities of the department / college may be compensated by conducting classes on Saturdays.

 PRINCIPAL
 K. S. R. INSTITUTE FOR
 ENGINEERING AND TECHNOLOGY
 K. S. R. KALVI NAGAR,
 TIRUCHENGODE-631 215,
 NAMAKKAL DS, TAMIL NADU.

 DIRECTOR
 ACADEMIC COURSES

ANNA UNIVERSITY, CHENNAI
ACADEMIC SCHEDULE
for the
September 2017 – December 2017 ODD SEMESTER ACADEMIC SESSION OF THE
ACADEMIC YEAR 2017 – 2018
I SEMESTER

PG (FT) Degree Programmes offered at Affiliated Engineering Colleges

Sl. No	Programme	Semester	Commencement of Classes	Last working day	Commencement of End Semester Examinations
1.	M.E. / M. Tech. / M. Arch./ M.B.A./ M.C.A (FT)	I	06.09.2017	26.12.2017	02.01.2018

RE-OPENING DAY FOR THE NEXT SEMESTER: 29.01.2018 (Monday)

NOTE:

1. Theory and Practical Examination schedules will be published in due course. (Practical Examinations will be conducted before the theory examinations).
2. If necessary, loss of classes due to various curricular / co-curricular activities of the department / college may be compensated by conducting classes on Saturdays.

 PRINCIPAL
 K. S. R. INSTITUTE FOR
 ENGINEERING AND TECHNOLOGY,
 K. E. R. KAVI NAGAR,
 TIRUCHENGOORE-605 215,
 NAMBIAL ST, TIRUCHENGOORE.

DIRECTOR
ACADEMIC COURSES

ANNA UNIVERSITY:: CHENNAI- 600 025
ACADEMIC AND ASSESSMENT SCHEDULE

December 2017 – June 2018 - Even Semester
ALL UG / PG (Full Time / Part Time)

S.No	Event	Date / Period
1.	Commencement of Even Semester	18-12-2017
2.	Last date for Registration of Electives	03-01-2018
3.	Publication of End semester Exam Time Table	22.01.2018
4.	Conduct of 1 st assessment test	05-02-2018 – 10-02-2018
5.	Last date for 1 st assessment Mark Entry	20-02-2018
6.	Conduct of 2 nd assessment test	02-03-2018 – 08-03-2018
7.	Last date for 2 nd assessment Mark Entry	19-03-2018
8.	Last day for Payment of Examination Fees	15-03-2018
9.	Conduct of 3 rd assessment test	28-03-2018 – 05-04-2018
10.	Last date for 3 rd assessment Mark Entry	12-04-2018
11.	Last working day	10-04-2018
12.	Issue of Hall Tickets	11-04-2018
13.	Conduct of Practical Examinations	12-04-2018
14.	Conduct of End Semester Examinations	23-04-2018
15.	Summer vacation	From End of Exam date up to 01-07-2018
16.	Commencement of classes for ODD semester	02-07-2018(Tentative)

Assessment Schedule for the Academic session of
December 2017 – June 2018 - Even Semester

Report. No	Report Period	Test Period	Web Portal Entry Period
1.	18-12-2017 – 12-01-2018	No Test	17-01-2018 – 24-01-2018
2.	17-01-2018 – 13-02-2018	05-02-2018 – 10-02-2018	13-02-2018 – 20-02-2018
3.	14-02-2018 – 12-03-2018	02-03-2018 – 08-03-2018	12-03-2018 – 19-03-2018
4.	13-03-2018 – 10-04-2018	28-03-2018 – 05-04-2018	10-04-2018 – 12-04-2018

 PRINCIPAL,
 K. S. R. INSTITUTE FOR
 ENGINEERING AND TECHNOLOGY,
 K. S. R. KALVINAGAR,
 TIRUCHENGODE-637 215,
 NAMAKKAL DL, TAMIL NADU.

 23/12/17
 CONTROLLER OF EXAMINATIONS

Date: 18.11.2017

ANNA UNIVERSITY : CHENNAI – 600 025

ACADEMIC SCHEDULE

for the

December 2017 – May 2018 (EVEN SEMESTER – Except II Semester) Session of the
ACADEMIC YEAR 2017 – 2018

UG & PG Degree Programmes offered in Affiliated Engineering Colleges

Sl. No.	Programme	Semester	Commencement of Classes	Last working day	Commencement of Practical Examinations	Commencement of End Semester Examinations
1.	B.E. / B.Tech.(Full-Time)	IV, VI, VIII	18.12.2017	10.04.2018	12.04.2018	23.04.2018
2.	B.E. (Part-Time)	III, V, VII				
3.	B.Arch. (Full-Time)	IV, VI, VIII, X				
4.	M.E. / M.Tech / M.Arch.(FT)	IV				
5.	M.C.A. (Full-Time)	IV, VI				
6.	M.B.A. (FT)	IV				
7.	M.Sc (5 Yrs-Integrated)	IV, VI, VIII, X				
8.	M.B.A. (5 Yrs-Integrated)	IV				

RE - OPENING DAY FOR THE NEXT SEMESTER: 02.07.2018 (Monday)

NOTE:

1. The Theory and Practical Examination schedules will be published in the due course (Practical Examinations will be conducted before the theory examinations).
2. If necessary, loss of classes due to various curricular / co-curricular activities of the department / college may be compensated by conducting classes on Saturdays.

ENGINEERING COLLEGE,
TIRUCHENGODE-647 215,
NAMAKKAL DI, TAMIL NADU.

DIRECTOR
ACADEMIC COURSES

ANNA UNIVERSITY:: CHENNAI- 600 025
ACADEMIC AND ASSESSMENT SCHEDULE

January 2018 – May 2018 – Second Semester
(Regulations – 2017 only)
ALL UG / PG (Full Time / Part Time)

S.No	Event	Date / Period
1	Commencement of Second Semester	22-01-2018
2	Last date for Registration of Electives	10-02-2018
3	Publication of End semester Exam Time Table	29.01.2018
4	Conduct of 1 st assessment test	06-03-2018 – 14-03-2018
5	Last date for 1 st assessment Mark Entry	22-03-2018
6	Conduct of 2 nd assessment test	04-04-2018 – 10-04-2018
7	Last date for 2 nd assessment Mark Entry	19-04-2018
8	Last day for Payment of Examination Fees	14-04-2018
9	Conduct of 3 rd assessment test	25-04-2018 – 03-05-2018
10	Last date for 3 rd assessment Mark Entry	07-05-2018
11	Last working day	05-05-2018
12	Hall Ticket Generation	03-05-2018 to 06-05-2018
13	Commencement of Practical Examinations	07-05-2018
14	Commencement of End Semester Examinations	16-05-2018
15	Summer vacation	From 30.05.2018 to 01-07-2018
16	Commencement of classes for next semester	02-07-2018

January 2018 – May 2018 – Second Semester
(Regulations – 2017 only)
ALL UG / PG (Full Time / Part Time)

Report. No	Report Period	Test Period	Web Portal Entry Period
1.	22-01-2018 – 16-02-2018	No Test	17-02-2018 – 24-02-2018
2.	17-02-2018 – 14-03-2018	06-03-2018 – 14-03-2018	14-03-2018 – 22-03-2018
3.	15-03-2018 – 10-04-2018	04-04-2018 – 10-04-2018	10-04-2018 – 19-04-2018
4.	11-04-2018 – 03-05-2018	25-04-2018 – 03-05-2018	03-05-2018 – 07-05-2018

---Sd---
 Controller of Examinations

PRINCIPAL,
K. S. R. INSTITUTE FOR
ENGINEERING AND TECHNOLOGY,
K. S. R. KALU NAGAR,
TIRUCHENGODE-637 215,
NAMAKKAL DL, TAMIL NADU.

ACADEMIC SCHEDULE

for the

January 2018 – May 2018 (EVEN SEMESTER) SESSION OF THE
ACADEMIC YEAR 2017 – 2018UG & PG Degree Programmes offered in Affiliated Engineering Colleges

Sl. No.	Programme	Semester	Commencement of Classes	Last working day	Commencement of Practical Examinations	Commencement of End Semester Examinations
1.	B.E. / B.Tech.(Full-Time)	II	22.01.2018	05.05.2018**	07.05.2018	17.05.2018
2.	B.Arch. (Full-Time)	II				
3.	M.E. / M.Tech / M.Arch.(FT)	II				
4.	M.C.A. (Full-Time)	II				
5.	M.B.A. (FT)	II				
6.	M.Sc (5 Yrs-Integrated)	II				
7.	M.B.A. (5 Yrs-Integrated)	II				

RE - OPENING DAY FOR THE NEXT SEMESTER: 02.07.2018 (Monday)** - In order to ensure minimum no. of working days any 3 Saturdays should also be declared as working days.

NOTE:

1. The Theory and Practical Examination schedules will be published in the due course (Practical Examinations will be conducted before the theory examinations).
2. If necessary, loss of classes due to various curricular / co-curricular activities of the department / college may be compensated by conducting classes on Saturdays.



PRINCIPAL,
K. S. R. INSTITUTE FOR
ENGINEERING AND TECHNOLOGY,
K. S. R. KALVI NAGAR,
TIRUCHENGODE-637 215,
NAMAKKAL DI, TAMIL NADU.

DIRECTOR
ACADEMIC COURSES

ANNA UNIVERSITY, CHENNAI

ACADEMIC SCHEDULE

for the

July 2018 – December 2018 ODD SEMESTER ACADEMIC SESSION OF THE

ACADEMIC YEAR 2018 – 2019

UG & PG (Full-Time) Degree Programmes offered at Affiliated Engineering Colleges

Sl. No	Programme	Semester	Commencement of Classes	Last working day	Commencement of Practical Examinations	Commencement of End Semester Examinations
1.	B.E. / B. Tech.(Full-Time)	III, V, VII	02.07.2018	17.10.2018**	22.10.2018	01.11.2018
2.	B.E. / B. Tech.(Part-Time)	III, V, VII				
3.	B. Arch.(Full-Time)	III, V, VII, IX				
4.	M.E. / M. Tech./ M. Arch. (FT)	III				
5.	M.C.A. (Full-Time)	III, V				
6.	M.B.A. (Full-Time)	III				
7.	M.Sc.(5 Yrs - Integrated)	III, V, VII, IX				
8.	M.B.A.(5 Yrs – Integrated)	III, V				

RE-OPENING DAY FOR THE NEXT SEMESTER: 17.12.2018 (Monday)** - In order to ensure minimum no. of working days any 1 Saturday should also be declared as working day

NOTE:

1. Theory and Practical Examination schedules will be published in due course. (Practical Examinations will be conducted before the theory examinations).
2. If necessary, loss of classes due to various curricular / co-curricular activities of the department / college may be compensated by conducting classes on Saturdays.

PRINCIPAL,
K. S. R. INSTITUTE FOR
ENGINEERING AND TECHNOLOGY,
K. S. R. HALVINAGAR,
TIRUCHENGODE-637 215,
NAMAKKAL Dt, TAMIL NADU.

S.L.
13/6/18
DIRECTOR
ACADEMIC COURSES

ANNA UNIVERSITY, CHENNAI

ACADEMIC SCHEDULE

for the

September 2018 – December 2018 ODD SEMESTER ACADEMIC SESSION OF THE

ACADEMIC YEAR 2018 – 2019

I SEMESTER

PG (FT) Degree Programmes offered at Affiliated Engineering Colleges

Sl. No	Programme	Semester	Commencement of Classes	Last working day	Commencement of Practical Examinations	Commencement of End Semester Examinations
1.	M.B.A./ M.C.A (FT)	I	03.09.2018	10.12.2018**	12.12.2018	29.12.2018
2.	M.E. / M. Tech. / M. Arch.(FT)	I	10.09.2018	15.12.2018**	17.12.2018	29.12.2018

RE-OPENING DAY FOR THE NEXT SEMESTER: 30.01.2019 (Wednesday)

NOTE:

1. Theory and Practical Examination schedules will be published in due course. (Practical Examinations will be conducted before the theory examinations).
2. If necessary, loss of classes due to various curricular / co-curricular activities of the department / college may be compensated by conducting classes on Saturdays.

** In order to ensure minimum no. of working days, the following 11 Saturdays are declared as working days.

Sl. No.	Working Days (Saturdays)	Time Table of the Week Day to be Followed
1.	15.09.2018	Thursday
2.	29.09.2018	Friday
3.	06.10.2018	Tuesday
4.	13.10.2018	Thursday
5.	27.10.2018	Friday
6.	03.11.2018	Tuesday

Sl. No.	Working Days (Saturdays)	Time Table of the Week Day to be Followed
7.	10.11.2018	Wednesday
8.	17.11.2018	Thursday
9.	24.11.2018	Friday
10.	01.12.2018	Monday
11.	08.12.2018	Tuesday

PRINCIPAL,
K. S. R. INSTITUTE FOR
ENGINEERING AND TECHNOLOGY,
K. S. R. HALVINAGAR,
TIRUCHENGODE-637 215,
NAMAKKAL Dt., TAMIL NADU.

DIRECTOR
ACADEMIC COURSES: 5/5

ANNA UNIVERSITY, CHENNAI
ACADEMIC SCHEDULE
 for the
September 2018 – December 2018 ODD SEMESTER ACADEMIC SESSION OF THE
ACADEMIC YEAR 2018 – 2019
I SEMESTER

UG (FT) Degree Programmes offered at Affiliated Engineering Colleges

Sl. No.	Programme	Semester	Commencement of Classes	Last working day	Commencement of Practical Examinations	Commencement of End Semester Examinations
1.	B.E. / B.Tech. (Full Time)	I	03.09.2018	10.12.2018**	12.12.2018	29.12.2018
2.	B.Arch. (Full-Time)	I				

RE-OPENING DAY FOR THE NEXT SEMESTER: 28.01.2019 (Monday)

NOTE:

1. Theory and Practical Examination schedules will be published in due course. (Practical Examinations will be conducted before the theory examinations).
2. If necessary, loss of classes due to various curricular / co-curricular activities of the department / college may be compensated by conducting classes on Saturdays.

** - In order to ensure minimum no. of working days any 11 Saturdays should also be declared as working days.

Sl. No.	Working Days (Saturdays)	Time Table of the Week Day to be Followed
1.	15.09.2018	Monday
2.	29.09.2018	Tuesday
3.	06.10.2018	Wednesday
4.	13.10.2018	Thursday
5.	27.10.2018	Friday
6.	03.11.2018	Monday

Sl. No.	Working Days (Saturdays)	Time Table of the Week Day to be Followed
7.	10.11.2018	Tuesday
8.	17.11.2018	Wednesday
9.	24.11.2018	Thursday
10.	01.12.2018	Friday
11.	08.12.2018	Monday

FOR
 K. S. R. ENGINEERING COLLEGE
 ENGINEERING COLLEGE
 K. S. R. ENGINEERING COLLEGE
 TIRU
 MANAGERIAL & TRAINING DEPT.

DIRECTOR
 ACADEMIC COURSES

ANNA UNIVERSITY: : CHENNAI – 600 025

ACADEMIC SCHEDULE

ACADEMIC YEAR 2018 – 2019

December 2018 – May 2019 Session (EVEN SEMESTER – Except II Semester)

UG & PG Degree Programmes offered in Affiliated Engineering Colleges

Sl. No.	Programme	Semester	Commencement of Classes	Last working day	Commencement of Practical Examinations	Commencement of End Semester Examinations
1.	B.E. / B.Tech.(Full-Time)	IV,VI,VIII	19.12.2018	22.03.2019**	25.03.2019	08.04.2019
2.	B.E. / B.Tech (Part-Time)	IV,VI				
3.	B.Arch. (Full-Time)	IV,VI,VIII,X				
4.	M.E. / M.Tech./ M.Arch.(FT)	IV				
5.	M.C.A. (Full-Time)	IV,VI				
6.	M.B.A. (FT)	IV				
7.	M.Sc (5 Yrs-Integrated)	IV,VI,VIII,X				
8.	M.B.A. (5 Yrs-Integrated)	IV,VI				

RE - OPENING DAY FOR THE NEXT SEMESTER: 01.07.2019 (Monday)

NOTE:

- The Theory and Practical Examination schedules will be published in due course (Practical Examinations will be conducted before the theory examinations).
 - If necessary, loss of classes due to various curricular / co-curricular activities of the department / college may be compensated by conducting classes on Saturdays.
- ** In order to ensure minimum no. of working days, the following 12 Saturdays are declared as working days.

Sl. No.	Working Days (Saturdays)	Time Table of the Week Day to be Followed	Sl. No.	Working Days (Saturdays)	Time Table of the Week Day to be Followed
1.	22.12.2018	Tuesday	7.	09.02.2019	Tuesday
2.	29.12.2018	Tuesday	8.	16.02.2019	Wednesday
3.	05.01.2019	Tuesday	9.	23.02.2019	Thursday
4.	12.01.2019	Wednesday	10.	02.03.2019	Friday
5.	19.01.2019	Thursday	11.	09.03.2019	Monday
6.	02.02.2019	Monday	12.	16.03.2019	Tuesday

PRINCIPAL
K. S. R. INSTITUTE FOR
ENGINEERING AND TECHNOLOGY,
K. S. R. KALVI NAGAR,
TIRUCHENGODE-637 215,
NAMAKKAL DL, TAMIL NADU.

DIRECTOR
ACADEMIC COURSES

ANNA UNIVERSITY : CHENNAI – 600 025

ACADEMIC SCHEDULE

for the

January 2019 – May 2019 (EVEN SEMESTER – II Semester) SESSION OF THE
ACADEMIC YEAR 2018 – 2019UG & PG Degree Programmes offered in Affiliated Engineering Colleges

Sl. No.	Programme	Semester	Commencement of Classes	Last working day	Commencement of Practical Examinations	Commencement of End Semester Examinations
1.	B.E. / B.Tech.(Full-Time)	II	21.01.2019	22.04.2019**	24.04.2019	06.05.2019
2.	B.Arch. (Full-Time)	II				
3.	M.E. / M.Tech. / M.Arch.(FT)	II				
4.	M.C.A. (Full-Time)	II				
5.	M.B.A. (FT)	II				
6.	M.Sc (5 Yrs-Integrated)	II				
7.	M.B.A. (5 Yrs-Integrated)	II				

RE - OPENING DAY FOR THE NEXT SEMESTER: 01.07.2019 (Monday)

NOTE:

- The Theory and Practical Examination schedules will be published in the due course (Practical Examinations will be conducted before the theory examinations).
 - If necessary, loss of classes due to various curricular / co-curricular activities of the department / college may be compensated by conducting classes on Saturdays.
- ** In order to ensure minimum no. of working days, the following 11 Saturdays are declared as working days.

Sl. No.	Working Days (Saturdays)	Time Table of the Week Day to be Followed
1.	02.02.2019	Tuesday
2.	09.02.2019	Wednesday
3.	16.02.2019	Thursday
4.	23.02.2019	Monday
5.	02.03.2019	Tuesday

Sl. No.	Working Days (Saturdays)	Time Table of the Week Day to be Followed
6.	09.03.2019	Wednesday
7.	16.03.2019	Thursday
8.	23.03.2019	Friday
9.	30.03.2019	Monday
10.	13.04.2019	Wednesday
11.	20.04.2019	Friday

PRINCIPAL,
K. S. R. INSTITUTE FOR
ENGINEERING AND TECHNOLOGY,
K. S. R. KALVI NAGAR,
TIRUCHENGODE-637 215,
NAMAKKAL DL, TAMIL NADU.

DIRECTOR
ACADEMIC COURSES

ANNA UNIVERSITY, CHENNAI
ACADEMIC SCHEDULE
 for the

July 2019 – December 2019 ODD SEMESTER ACADEMIC SESSION OF THE
ACADEMIC YEAR 2019 – 2020
 UG & PG (Full-Time) Degree Programmes offered at Affiliated Engineering Colleges

Sl. No	Programme	Semester	Commencement of Classes	Last working day	Commencement of Practical Examinations	Commencement of End Semester Examinations
1.	B.E. / B. Tech.(Full-Time)	III, V, VII	01.07.2019	19.10.2019**	21.10.2019	06.11.2019
2.	B.E. / B. Tech.(Part-Time)	III, V, VII				
3.	B. Arch.(Full-Time)	III, V, VII, IX				
4.	M.E. / M. Tech./ M. Arch. (FT)	III				
5.	M.C.A. (Full-Time)	III, V				
6.	M.B.A. (Full-Time)	III				
7.	M.Sc.(5 Yrs - Integrated)	III, V, VII, IX				
8.	M.B.A. (5 Yrs – Integrated)	III, V, VII				

RE-OPENING DAY FOR THE NEXT SEMESTER: 16.12.2019 (Monday)

NOTE:

1. Theory and Practical Examination schedules will be published in due course. (Practical Examinations will be conducted before the theory examinations).
2. If necessary, loss of classes due to various curricular / co-curricular activities of the department / college may be compensated by conducting classes on Saturdays.

** In order to ensure minimum no. of working days, the following 3 Saturdays are declared as working days.

Sl. No.	Working Days (Saturdays)	Time Table of the Week Day to be Followed
1.	03.08.2019	Monday
2.	07.09.2019	Tuesday

Sl. No.	Working Days (Saturdays)	Time Table of the Week Day to be Followed
3.	19.10.2019	Wednesday

TIRUCHENGODUR-637 215,
NAMAKKALDE, KARIL NADU.

DIRECTOR
ACADEMIC COURSES

ANNA UNIVERSITY, CHENNAI
ACADEMIC SCHEDULE
 for the
September 2019 – December 2019 ODD SEMESTER ACADEMIC SESSION OF THE
ACADEMIC YEAR 2019 – 2020
I SEMESTER

PG (FT) Degree Programmes offered at Affiliated Engineering Colleges

Sl. No	Programme	Semester	Commencement of Classes	Last working day	Commencement of End Semester Examinations
1.	M.B.A./ M.C.A (FT)	I	12.09.2019	14.12.2019**	16.12.2019
2.	M.E. / M. Tech. / M. Arch.(FT)	I			

RE-OPENING DAY FOR THE NEXT SEMESTER: 29.01.2020 (Wednesday)

NOTE:

- Theory and Practical Examination schedules will be published in due course. (Practical Examinations will be conducted after the theory examinations).
- If necessary, loss of classes due to various curricular / co-curricular activities of the department / college may be compensated by conducting classes on Saturdays.

** In order to ensure minimum no. of working days, the following 11 Saturdays are declared as working days.

Sl. No.:	Working Days (Saturdays)	Time Table of the Week Day to be Followed
1.	14.09.2019	Wednesday
2.	21.09.2019	Monday
3.	28.09.2019	Tuesday
4.	12.10.2019	Monday
5.	26.10.2019	Tuesday
6.	02.11.2019	Wednesday

Sl. No.	Working Days (Saturdays)	Time Table of the Week Day to be Followed
7.	16.11.2019	Thursday
8.	23.11.2019	Friday
9.	30.11.2019	Monday
10.	07.12.2019	Tuesday
11.	14.12.2019	Wednesday

PRINCIPAL
 K. S. R. INSTITUTE FOR
 ENGINEERING AND TECHNOLOGY,
 K. S. R. KALVI NAGAR,
 TIRUCHENGODE-637 215,
 NAMAKKAL DI, TAMIL NADU.

DIRECTOR
 ACADEMIC COURSES

ANNA UNIVERSITY, CHENNAI
ACADEMIC SCHEDULE
for the
AUGUST 2019 – DECEMBER 2019 ODD SEMESTER ACADEMIC SESSION OF THE
ACADEMIC YEAR 2019 – 2020
I SEMESTER

UG (Part Time) Degree Programmes offered at Affiliated Engineering Colleges

Sl. No.	Programme	Semester	Commencement of Classes	Last working day	Commencement of Practical Examinations	Commencement of End Semester Examinations
1.	B.E. / B.Tech. (Part Time)	I	05.08.2019	20.11.2019**	22.11.2019	02.12.2019

RE-OPENING DAY FOR THE NEXT SEMESTER: 06.01.2020 (Monday)

NOTE:

1. Theory and Practical Examination schedules will be published in due course. (Practical Examinations will be conducted before the theory examinations).
2. If necessary, loss of classes due to various curricular / co-curricular activities of the department / college may be compensated by conducting classes on Saturdays.

** In order to ensure minimum no. of working days, the following Saturdays are declared as working days.

Sl. No.	Working Days (Saturdays)	Time Table of the Week Day to be Followed
1.	10.08.2019	Monday
2.	31.08.2019	Thursday
3.	07.09.2019	Friday

Sl. No.	Working Days (Saturdays)	Time Table of the Week Day to be Followed
4.	05.10.2019	Tuesday
5.	02.11.2019	Wednesday

PRINCIPAL,
K. S. R. INSTITUTE FOR
ENGINEERING AND TECHNOLOGY,
K. S. R. KALVI NAGAR,
TIRUCHENGODE-637 215,
NAMAKKAL DL. TAMIL NADU.

DIRECTOR
ACADEMIC COURSES

ANNA UNIVERSITY: : CHENNAI – 600 025

ACADEMIC SCHEDULE

ACADEMIC YEAR 2019 – 2020

December 2019 – May 2020 Session (EVEN SEMESTER – Except II Semester)

UG & PG Degree Programmes offered in Affiliated Engineering Colleges

Sl. No.	Programme	Semester	Commencement of Classes	Last working day	Commencement of Practical Examinations	Commencement of End Semester Examinations
1.	B.E. / B.Tech.(Full-Time)	IV,VI,VIII	16.12.2019	27.03.2020**	30.03.2020	17.04.2020
2.	B.E. / B.Tech (Part-Time)	IV,VI				
3.	B.Arch. (Full-Time)	IV,VI,VIII,X				
4.	M.E. / M.Tech./ M.Arch.(FT)	IV				
5.	M.C.A. (Full-Time)	IV,VI				
6.	M.B.A. (FT)	IV				
7.	M. Sc (5 Yrs-Integrated)	IV,VI,VIII,X				
8.	M.B.A (5 Yrs-Integrated)	IV,VI,VIII				

RE - OPENING DAY FOR THE NEXT SEMESTER: 01.07.2020 (Wednesday)

NOTE:

- The Theory and Practical Examination schedules will be published in due course (Practical Examinations will be conducted before the theory examinations).
 - If necessary, loss of classes due to various curricular / co-curricular activities of the department / college may be compensated by conducting classes on Saturdays.
- ** In order to ensure minimum no. of working days, the following 6 Saturdays are declared as working days.

Sl. No.	Working Days (Saturdays)	Time Table of the Week Day to be Followed	Sl. No.	Working Days (Saturdays)	Time Table of the Week Day to be Followed
1.	25.01.2020	Wednesday	4.	29.02.2020	Thursday
2.	01.02.2020	Wednesday	5.	07.03.2020	Friday
3.	15.02.2020	Wednesday	6.	21.03.2020	Wednesday

PRINCIPAL,
K. S. R. INSTITUTE FOR
ENGINEERING AND TECHNOLOGY,
K. S. R. KALVI NAGAR,
TIRUCHENGODE-637 215,
NAMAKKAL DL TAMIL NADU.

S. Rajasekar 03/12/19
DIRECTOR
ACADEMIC COURSES

ANNA UNIVERSITY : CHENNAI – 600 025

ACADEMIC SCHEDULE

for the

January 2020 – May 2020 (Even Semester – II Semester) Session of the

ACADEMIC YEAR 2019 – 2020

PG Degree Programmes offered in Affiliated Engineering Colleges

Sl. No.	Programme	Semester	Commencement of Classes	Last working day	Commencement of Practical Examinations	Commencement of End Semester Examinations
1.	M.E. / M.Tech. / M.Arch.(FT)	II	29.01.2020	29.04.2020**	30.04.2020	08.05.2020
2.	M.C.A. (Full-Time)	II				
3.	M.B.A. (Full-Time)	II				
4.	M.B.A. (5 Yrs-Integrated)	II				

RE - OPENING DAY FOR THE NEXT SEMESTER: 01.07.2020 (Wednesday)

NOTE:

- The Theory and Practical Examination schedules will be published in due course (Practical Examinations will be conducted before the theory examinations).
- If necessary, loss of classes due to various curricular / co-curricular activities of the department / college may be compensated by conducting classes on Saturdays.

**In order to ensure minimum no. of working days, the following 13 Saturdays are declared as working days.

Sl. No.	Working Days (Saturdays)	Time Table of the Week Day to be Followed	Sl. No.	Working Days (Saturdays)	Time Table of the Week Day to be Followed
1.	01.02.2020	Wednesday	7.	14.03.2020	Wednesday
2.	08.02.2020	Monday	8.	21.03.2020	Thursday
3.	15.02.2020	Friday	9.	28.03.2020	Friday
4.	22.02.2020	Tuesday	10.	04.04.2020	Monday
5.	29.02.2020	Monday	11.	11.04.2020	Tuesday
6.	07.03.2020	Tuesday	12.	18.04.2020	Wednesday
			13.	25.04.2020	Thursday

PRINCIPAL
K S R INSTITUTE FOR
ENGINEERING AND TECHNOLOGY,
K. S. R. KAMARAJ NAGAR,
TIRUCHENGODE-637 215,
NAMAKKAL DISTRICT, TAMIL NADU.

DIRECTOR
ACADEMIC COURSES

REVISED

ANNA UNIVERSITY: : CHENNAI – 600 025

ACADEMIC SCHEDULE

for the

January 2020 – May 2020 (Even Semester – II Semester) Session of the

ACADEMIC YEAR 2019 – 2020

UG Degree Programmes offered in Affiliated Engineering Colleges

Sl. No.	Programme	Semester	Commencement of Classes	Last working day	Commencement of Practical Examinations	Commencement of End Semester Examinations
1.	B.E. / B.Tech.(Full-Time)	II	20.01.2020	24.04.2020**	27.04.2020	11.05.2020
2.	B.Arch. (Full-Time)	II				
3.	B.E./ B.Tech. (Part Time)	II				

RE - OPENING DAY FOR THE NEXT SEMESTER: 01.07.2020 (Wednesday)

NOTE:

1. The Theory and Practical Examination schedules will be published in due course (Practical Examinations will be conducted before the theory examinations).
2. If necessary, loss of classes due to various curricular / co-curricular activities of the department / college may be compensated by conducting classes on Saturdays.

** In order to ensure minimum no. of working days, the following 9 Saturdays are declared as working days.

Sl. No.	Working Days (Saturdays)	Time Table of the Week Day to be Followed
1.	25.01.2020	Wednesday
2.	01.02.2020	Wednesday
3.	15.02.2020	Thursday
4.	29.02.2020	Friday
5.	07.03.2020	Wednesday

Sl. No.	Working Days (Saturdays)	Time Table of the Week Day to be Followed
6.	21.03.2020	Monday
7.	28.03.2020	Friday
8.	04.04.2020	Tuesday
9.	18.04.2020	Monday

PRINCIPAL,
K. S. R. INSTITUTE FOR
ENGINEERING AND TECHNOLOGY,
K. S. R. KALVINAGAR,
TIRUCHENGODE-637 213,
NAMAKKAL DISTRICT, TAMIL NADU.

S. S. S.
02.01.2020
DIRECTOR
ACADEMIC COURSES

ACADEMIC SCHEDULE REVISED

ODD Semester (2015-16)

JUN 2015 – DEC 2015

PROGRAMME: B.E/B.Tech Degree.

SEMESTER: I

S.No	Date(s)	Schedule
1.	04.08.2015	Commencement of Classes for 1 st Semester B.E
2.	12.09.2015	Completion of 2 Units for 1 year BE (31+1 working days)
3.	14.09.2015 – 21.09.2015	Internal Assessment Test I for all 1 year UG (1.5 units)
4.	10.10.2015	Completion of 2 Units (16+2 working days) Completion of All Lab Experiments
5.	12.10.2015 – 17.10.2015	Internal Assessment Test II for all 1 year UG (1.5 units)
6.	31.10.2015	Completion of 1 Unit (12+2 working days)
7.	02.11.2015	Revision Schedule Starts
8.	16.11.2015 – 21.11.2015	Model Exam
9.	23.11.2015	Tentative University Practical Exams*
10.	30.11.2015	Last Instruction Day*
11.	07.12.2015	University End Semester Examinations for BE
12.	04.01.2016	Reopening for next semester

*Subjected to Change

No. of Workings Days: 59+5 =64 before Revision including Compensation

Monday = 13

Wednesday = 12

Friday = 11

Tuesday = 13

Thursday = 10

Saturday = 5

K S R INSTITUTE FOR ENGINEERING AND TECHNOLOGY,
K. S. R. ROAD, TIRUCHENGODE-637 215,
DISTRICT OF TAMIL NADU.

PRINCIPAL

ACADEMIC SCHEDULE

AUGUST 2015

SEPTEMBER 2015

Date	Day	Particulars	No. of Working Days
1	SATURDAY		
2	SUNDAY	HOLIDAY	
3	MONDAY	ADI PERUKU-HOLIDAY	
4	TUESDAY	Commencement of Classes for 1 st Sem B.E	1
5	WEDNESDAY		2
6	THURSDAY		3
7	FRIDAY		4
	SATURDAY	Compensation for 3 rd August - MONDAY ORDER	5
9	SUNDAY		
10	MONDAY		6
11	TUESDAY		7
12	WEDNESDAY		8
13	THURSDAY		9
14	FRIDAY		10
15	SATURDAY	INDEPENDENCE DAY - HOLIDAY	
16	SUNDAY	HOLIDAY	
17	MONDAY		11
18	TUESDAY		12
19	WEDNESDAY		13
	THURSDAY		14
21	FRIDAY		15
22	SATURDAY	FOURTH SATURDAY - HOLIDAY	
23	SUNDAY	HOLIDAY	
24	MONDAY		16
25	TUESDAY		17
26	WEDNESDAY		18
27	THURSDAY		19
28	FRIDAY		20
29	SATURDAY		A
30	SUNDAY	HOLIDAY	
31	MONDAY		21

Date	Day	Particulars	No. of Working Days
1	TUESDAY		22
2	WEDNESDAY		23
3	THURSDAY		24
4	FRIDAY		25
5	SATURDAY	KRISHNAJAYANTHI - HOLIDAY	
6	SUNDAY	HOLIDAY	
7	MONDAY		26
8	TUESDAY		27
9	WEDNESDAY		28
10	THURSDAY		29
11	FRIDAY		30
12	SATURDAY	Compensation For 25 th Sep - FRIDAY ORDER	31
13	SUNDAY	HOLIDAY	
14	MONDAY	Internal Assessment- I S1	32
15	TUESDAY	S2	33
16	WEDNESDAY	S3	34
17	THURSDAY	VINAYAKAR CHATHURTHI - HOLIDAY	
18	FRIDAY	S4	35
19	SATURDAY	S5	B
20	SUNDAY	HOLIDAY	
21	MONDAY	S6	36
22	TUESDAY		37
23	WEDNESDAY		38
24	THURSDAY	BAKRID - HOLIDAY	
25	FRIDAY	Sandwich Holiday	
26	SATURDAY	FOURTH SATURDAY - HOLIDAY	
27	SUNDAY	HOLIDAY	
28	MONDAY		39
29	TUESDAY		40
30	WEDNESDAY		41

K S R FOR
ENGINEERING AND TECHNOLOGY,
K. S. R. KALVI NAGAR,
TIRUCHENGODE-637 215,
NAMAKKAL DI, TAMIL NADU.

OCTOBER 2015

Date	Day	Particulars	No. of Working Days
1	THURSDAY		42
2	FRIDAY	GANDHI JAYANTHI - HOLIDAY	
3	SATURDAY	Sandwich Holiday	
4	SUNDAY	HOLIDAY	
5	MONDAY		43
6	TUESDAY		44
7	WEDNESDAY		45
8	THURSDAY		46
9	FRIDAY		47
10	SATURDAY	Compensation For 3 rd Oct	C
11	SUNDAY	HOLIDAY	
12	MONDAY	Internal Assessment-II S1	48
13	TUESDAY	S2	49
14	WEDNESDAY	S3	50
15	THURSDAY	S4	51
16	FRIDAY	S5	52
17	SATURDAY	S6	D
18	SUNDAY	HOLIDAY	
19	MONDAY		53
20	TUESDAY		54
21	WEDNESDAY	SARASWATHI POOJA - HOLIDAY	
22	THURSDAY	VIJAYA DASAMI - HOLIDAY	
23	FRIDAY	MOHARRAM* - HOLIDAY	
24	SATURDAY	FOURTH SATURDAY - HOLIDAY	
25	SUNDAY	HOLIDAY	
26	MONDAY		55
27	TUESDAY		56
28	WEDNESDAY		57
29	THURSDAY		58
30	FRIDAY		59
31	SATURDAY		E

*Subjected to change

NOVEMBER 2015

Date	Day	Particulars	No. of Working Days
1	SUNDAY	HOLIDAY	
2	MONDAY	Revision Starts	60
3	TUESDAY	S1 test - FN	61
4	WEDNESDAY	S2 test - AN	62
5	THURSDAY		63
6	FRIDAY	S3 test - FN	64
7	SATURDAY	S4 test - AN	F
8	SUNDAY	HOLIDAY	
9	MONDAY	HOLIDAY	
10	TUESDAY	DEEPAVALI - HOLIDAY	
11	WEDNESDAY	HOLIDAY	
12	THURSDAY		65
13	FRIDAY	S5 test - FN	66
14	SATURDAY	Compensation for 9 th Oct- MONDAY ORDER S6 test - AN	67
15	SUNDAY	HOLIDAY	
16	MONDAY	Model test S1	68
17	TUESDAY	S2	69
18	WEDNESDAY	S3	70
19	THURSDAY	S4	71
20	FRIDAY	S5	72
21	SATURDAY	S6	G
22	SUNDAY	HOLIDAY	
23	MONDAY	Tentative University Practical Examinations*	73
24	TUESDAY		74
25	WEDNESDAY		75
26	THURSDAY		76
27	FRIDAY		77
28	SATURDAY	FOURTH SATURDAY - HOLIDAY	
29	SUNDAY	HOLIDAY	
30	MONDAY	Last Instruction Day	78

PRINCIPAL
K. S. V INSTITUTE FOR
ENGINEERING AND TECHNOLOGY
K. S. R. KALVI NAGAR,
TIRUCHENGODE-637 215,
HAMARAKAL DI, TAMIL NADU.

K S R INSTITUTE FOR ENGINEERING AND TECHNOLOGY TIRUCHENGODE – 637 215.

ACADEMIC SCHEDULE

EVEN Semester (2015-16)

JAN 2016 - MAY 2016

PROGRAMME: B.E/B.Tech Degree

SEMESTER: VIII

S.No	Date(s)	Schedule
1.	01.02.2016	Commencement of theory Classes for 8 th Semester B.E
2.	28.01.2016 – 29.01.2016	<i>Internal Assessment Test I for IV CSE & IT (2 units)</i>
3.	10.02.2016 – 12.02.2016	<i>Internal Assessment Test I for IV MECH, EEE & ECE (2 units)</i>
4.	03.02.2016 – 04.02.2016	<i>Internal Assessment Test II for IV CSE (2 units)</i>
5.	08.02.2016 – 09.02.2016	<i>Internal Assessment Test II for IV IT (2 units)</i>
6.	25.02.2016 – 29.02.2016	<i>Internal Assessment Test II for IV MECH, EEE & ECE (2 units)</i>
7.	30.03.2016	UG Project Report Submission
8.	31.03.2016 – 02.04.2016	<i>Internal Assessment Test III for IV MECH & EEE (2 units)</i>
9.	01.04.2016 – 02.04.2016	<i>Internal Assessment Test III for IV CSE, ECE & IT (2 units)</i>
10.	11.04.2016	Tentative Commencement of University Practical Exams*
11.	22.04.2016	Tentative Last Instruction Day*
12.	April last week	Tentative Commencement of End Semester Examinations*

*Subjected to Change



PRINCIPAL



PRINCIPAL,
K S R INSTITUTE FOR
ENGINEERING AND TECHNOLOGY,
TIRUCHENGODE-637 215,
NAMAKKAL DL, TAMIL NADU.

ACADEMIC SCHEDULE

FEBRUARY 2016

MARCH 2016

Date	Day	Particulars	No. of Working Days
1	MONDAY	<i>Commencement of theory classes for 8th Semester B.E</i>	1
2	TUESDAY		2
3	WEDNESDAY		3
4	THURSDAY		4
5	FRIDAY		5
6	SATURDAY		A
7	SUNDAY	HOLIDAY	
8	MONDAY		6
9	TUESDAY		7
10	WEDNESDAY		8
11	THURSDAY		9
12	FRIDAY		10
13	SATURDAY	SECOND SATURDAY - HOLIDAY	
14	SUNDAY	HOLIDAY	
15	MONDAY		11
16	TUESDAY		12
17	WEDNESDAY		13
18	THURSDAY		14
19	FRIDAY		15
20	SATURDAY	<i>Founder's Day* - holiday for Students Only</i>	
21	SUNDAY	HOLIDAY	
22	MONDAY		16
23	TUESDAY		17
24	WEDNESDAY		18
25	THURSDAY		19
26	FRIDAY		20
27	SATURDAY	FOURTH SATURDAY - HOLIDAY	
28	SUNDAY	HOLIDAY	
29	MONDAY		21

Date	Day	Particulars	No. of Working Days
1	TUESDAY		22
2	WEDNESDAY		23
3	THURSDAY		24
4	FRIDAY		25
5	SATURDAY		B
6	SUNDAY	HOLIDAY	
7	MONDAY		26
8	TUESDAY		27
9	WEDNESDAY		28
10	THURSDAY		29
11	FRIDAY		30
12	SATURDAY	SECOND SATURDAY - HOLIDAY	
13	SUNDAY	HOLIDAY	
14	MONDAY		31
15	TUESDAY		32
16	WEDNESDAY		33
17	THURSDAY		34
18	FRIDAY		35
19	SATURDAY		C
20	SUNDAY	HOLIDAY	
21	MONDAY		36
22	TUESDAY		37
23	WEDNESDAY		38
24	THURSDAY		39
25	FRIDAY	GOOD FRIDAY - HOLIDAY	
26	SATURDAY	FOURTH SATURDAY - HOLIDAY	
27	SUNDAY	HOLIDAY	
28	MONDAY		40
29	TUESDAY		41
30	WEDNESDAY	<i>Project report submission</i>	42
31	THURSDAY		43



 PRINCIPAL,
 K. J. S. ENGINEERING COLLEGE,
 ENCHAVAYAL, TIRUCHENGODE,
 N. S. ROAD, TIRUCHENGODE - 621101,
 TIRUCHENGODE - 621101,
 NAMAKKAL DISTRICT, TAMIL NADU.

APRIL 2016

MAY 2016

Date	Day	Particulars	No. of Working Days
1	FRIDAY		44
2	SATURDAY		D
3	SUNDAY	HOLIDAY	
4	MONDAY		45
5	TUESDAY		46
6	WEDNESDAY		47
7	THURSDAY		48
8	FRIDAY	TELUGU NEW YEAR - HOLIDAY	
9	SATURDAY	SECOND SATURDAY - HOLIDAY	
10	SUNDAY	HOLIDAY	
11	MONDAY	Tentative University Practical Examinations*	49
12	TUESDAY		50
13	WEDNESDAY		51
14	THURSDAY	TAMIL NEW YEAR - Dr. AMBEDKAR BIRTHDAY - HOLIDAY	
15	FRIDAY		52
16	SATURDAY		E
17	SUNDAY	HOLIDAY	
18	MONDAY		53
19	TUESDAY	MAHAVEER JAYANTHI - HOLIDAY	
20	WEDNESDAY		54
21	THURSDAY		55
22	FRIDAY	Tentative Last Instruction Day*	56
23	SATURDAY	FOURTH SATURDAY - HOLIDAY	
24	SUNDAY	HOLIDAY	
25	MONDAY		57
26	TUESDAY		58
27	WEDNESDAY		59
28	THURSDAY	Tentative End Semester Examinations*	60
29	FRIDAY		61
30	SATURDAY		62

Date	Day	Particulars	No. of Working Days
1	SUNDAY	MAY DAY - HOLIDAY	
2	MONDAY		
3	TUESDAY		
4	WEDNESDAY		
5	THURSDAY		
6	FRIDAY		
7	SATURDAY		
8	SUNDAY	HOLIDAY	
9	MONDAY		
10	TUESDAY		
11	WEDNESDAY		
12	THURSDAY		
13	FRIDAY		
14	SATURDAY	SECOND SATURDAY - HOLIDAY	
15	SUNDAY	HOLIDAY	
16	MONDAY		
17	TUESDAY		
18	WEDNESDAY		
19	THURSDAY		
20	FRIDAY		
21	SATURDAY		
22	SUNDAY	HOLIDAY	
23	MONDAY		
24	TUESDAY		
25	WEDNESDAY		
26	THURSDAY		
27	FRIDAY		
28	SATURDAY	FOURTH SATURDAY - HOLIDAY	
29	SUNDAY	HOLIDAY	
30	MONDAY		
31	TUESDAY		

 PRINCIPAL
 K. S. R. ENGINEERING COLLEGE FOR
 ENGINEERING AND TECHNOLOGY
 K. S. R. ROAD, TIRUCHENGODE,
 TIRUCHENGODE-637 218,
 NAMAKKAL Dt. TAMIL NADU.

K S R INSTITUTE FOR ENGINEERING AND TECHNOLOGY TIRUCHENGODE – 637 215.

ACADEMIC SCHEDULE

EVEN Semester (2015-16)

JAN 2016 - MAY 2016

PROGRAMME: B.E/B.Tech Degree

SEMESTER: II , IV & VI

PROGRAMME: M.E/M.Tech Degree

SEMESTER: II & IV

S.No	Date(s)	Schedule
1.	18.01.2016	Commencement of theory Classes for 2 nd Semester B.E
2.	01.02.2016	Commencement of theory Classes for 4 th & 6 th Semester B.E & 2 nd & 4 th Semester M.E
3.	18.02.2016	Completion of 2 Units for BE for I yr (25+1 working days)
4.	19.02.2016 – 26.02.2016	<i>Internal Assessment Test I for first year BE (2 units)</i>
5.	26.02.2016	Completion of 2 Units for BE for II & III yr (20+2 working days)
6.	29.02.2016 – 05.03.2016	<i>Internal Assessment Test I for II & III year BE & I ME (2 units)</i>
7.	24.03.2016	Completion of 2 Units for BE (19+2 working days) – I year (14+1 working days) – II & III year
8.	28.03.2016 – 02.04.2016	<i>Internal Assessment Test II for I, II & III year BE & ME (2 units) *</i>
9.	13.04.2016	Completion of 1 Unit for BE (7 working days)
10.	15.04.2016 – 22.04.2016	<i>Internal Assessment Test III for I, II & III year BE & ME (2 units) *</i>
11.	25.04.2016	Tentative Commencement of University Practical Exams*
12.	07.05.2016	Tentative Last Instruction Day*
13.	May 2 nd week	Tentative Commencement of End Semester Examinations*
14.	July 1 st week	Reopening for next semester*

*Subjected to Change

 PRINCIPAL,
 K. S. R. INSTITUTE FOR
 ENGINEERING AND TECHNOLOGY,
 K. S. R. KALVI NAGAR,
 TIRUCHENGODE-637 215,
 NAMAKKAL DT, TAMIL NADU.

 PRINCIPAL

DETAILS OF WORKING DAYS FOR 2015-16 EVEN SEMESTER

S.No	Details	I Year	II & III Year
1.	Working Days Before IAT III	61+5 = 66	51+4= 55
2.	Monday	11	9
3.	Tuesday	10	9
4.	Wednesday	11	9
5.	Thursday	11	8
6.	Friday	7	6
7.	Saturday	4	2
8.	Total Class Working Days	54	43
9.	Test (IAT 1&2)	12	12
10.	Working Days Before LAT III	66	55
11.	IAT 3	6	6
12.	Total Working Days	72	61

 PRINCIPAL,
 K. S. R. INSTITUTE FOR
 ENGINEERING AND TECHNOLOGY,
 K. S. R. KALVI NAGAR,
 TIRUCHENGODE-637 215,
 NAMAKKAL DI, TAMIL NADU.

ACADEMIC SCHEDULE

Version: 2.0

JANUARY 2016

FEBRUARY 2016

Date	Day	Particulars	No. of Working Days
1	FRIDAY	NEW YEAR - HOLIDAY	
2	SATURDAY	HOLIDAY	
3	SUNDAY	HOLIDAY	
4	MONDAY		
5	TUESDAY		
6	WEDNESDAY		
7	THURSDAY		
8	FRIDAY		
9	SATURDAY	SECOND SATURDAY - Compensation For January 2 nd	
10	SUNDAY	HOLIDAY	
11	MONDAY		
12	TUESDAY		
13	WEDNESDAY		
14	THURSDAY	BOGI HOLIDAY	
15	FRIDAY	PONGAL - HOLIDAY	
16	SATURDAY	THIRUVALLUVAR DAY - HOLIDAY	
17	SUNDAY	UZHAVARTHIRUNAL - HOLIDAY	
18	MONDAY	Commencement of Classes for 2 nd Semester B.E	1
19	TUESDAY		2
20	WEDNESDAY		3
21	THURSDAY		4
22	FRIDAY		5
23	SATURDAY	FOURTH SATURDAY - Compensation For January 14 th - THURSDAY ORDER	6
24	SUNDAY	HOLIDAY	
25	MONDAY		7
26	TUESDAY	REPUBLIC DAY - HOLIDAY	
27	WEDNESDAY		8
28	THURSDAY		9
29	FRIDAY		10
30	SATURDAY		A*
31	SUNDAY	HOLIDAY	

Date	Day	Particulars	No. of Working Days
1	MONDAY	Commencement of theory classes for 4 th & 6 th Semester B.E & 2 nd & 4 th Semester ME	11
2	TUESDAY		12
3	WEDNESDAY		13
4	THURSDAY		14
5	FRIDAY		15
6	SATURDAY		A
7	SUNDAY	HOLIDAY	
8	MONDAY		16
9	TUESDAY		17
10	WEDNESDAY		18
11	THURSDAY		19
12	FRIDAY		20
13	SATURDAY	SECOND SATURDAY - HOLIDAY	
14	SUNDAY	HOLIDAY	
15	MONDAY		21
16	TUESDAY		22
17	WEDNESDAY		23
18	THURSDAY		24
19	FRIDAY	Internal Assessment- I for first year SI	25
20	SATURDAY	Founder's Day* - holiday for Students	
21	SUNDAY	HOLIDAY	
22	MONDAY	S2	26
23	TUESDAY	S3	27
24	WEDNESDAY	S4	28
25	THURSDAY	S5	29
26	FRIDAY	S6	30
27	SATURDAY	FOURTH SATURDAY - HOLIDAY	
28	SUNDAY	HOLIDAY	
29	MONDAY	Internal Assessment- I for II & III year & I ME SI	31



 PRINCIPAL,
 K B R INSTITUTE FOR
 ENGINEERING AND TECHNOLOGY,
 K. S. R. KALVI NAGAR,
 TIRUCHENGODE-637 215,
 NAMAKKAL Dt. TAMIL NADU.

MARCH 2016

APRIL 2016

Date	Day	Particulars	No. of Working Days
1	TUESDAY	S2	32
2	WEDNESDAY	S3	33
3	THURSDAY	S4	34
4	FRIDAY	S5	35
5	SATURDAY	S6	B
6	SUNDAY	HOLIDAY	
7	MONDAY		36
8	TUESDAY		37
9	WEDNESDAY		38
10	THURSDAY		39
11	FRIDAY		40
12	SATURDAY	SECOND SATURDAY - HOLIDAY	
13	SUNDAY	HOLIDAY	
14	MONDAY		41
15	TUESDAY		42
16	WEDNESDAY		43
17	THURSDAY		44
18	FRIDAY		45
19	SATURDAY		C
20	SUNDAY	HOLIDAY	
21	MONDAY		46
22	TUESDAY		47
23	WEDNESDAY		48
24	THURSDAY		49
25	FRIDAY	GOOD FRIDAY - HOLIDAY	
26	SATURDAY	FOURTH SATURDAY - HOLIDAY	
27	SUNDAY	HOLIDAY	
28	MONDAY	Internal Assessment- II for I,II & III BE & ME S1	50
29	TUESDAY	S2	51
30	WEDNESDAY	S3	52
31	THURSDAY	S4	53

Date	Day	Particulars	No. of Working Days
1	FRIDAY	S5	54
2	SATURDAY	S6	D
3	SUNDAY	HOLIDAY	
4	MONDAY		55
5	TUESDAY		56
6	WEDNESDAY		57
7	THURSDAY		58
8	FRIDAY	TELUGU NEW YEAR - HOLIDAY	
9	SATURDAY	SECOND SATURDAY - HOLIDAY	
10	SUNDAY	HOLIDAY	
11	MONDAY		59
12	TUESDAY		60
13	WEDNESDAY		61
14	THURSDAY	TAMIL NEW YEAR- Dr.AMBEDKAR BIRTHDAY - HOLIDAY	
15	FRIDAY	Internal Assessment- III for I,II & III BE & ME S1	62
16	SATURDAY	S2	E
17	SUNDAY	HOLIDAY	
18	MONDAY	S3	63
19	TUESDAY	MAHAVEER JAYANTHI - HOLIDAY	
20	WEDNESDAY	S4	64
21	THURSDAY	S5	65
22	FRIDAY	S6	66
23	SATURDAY	FOURTH SATURDAY - HOLIDAY	
24	SUNDAY	HOLIDAY	
25	MONDAY	Tentative University Practical Examinations*	67
26	TUESDAY		68
27	WEDNESDAY		69
28	THURSDAY		70
29	FRIDAY		71
30	SATURDAY		72

 PRINCIPAL,
 K P B INSTITUTE FOR
 ENGINEERING AND TECHNOLOGY,
 K. S. P. KA. SINGAR,
 TIRUCHENGODE-637 215,
 NAMAKKAL Dt. TAMIL NADU.

MAY 2016

Date	Day	Particulars	No. of Working Days
1	SUNDAY	MAY DAY - HOLIDAY	
2	MONDAY		73
3	TUESDAY		74
4	WEDNESDAY		75
5	THURSDAY		76
6	FRIDAY		77
7	SATURDAY	Tentative Last Instruction Day*	F
8	SUNDAY	HOLIDAY	
9	MONDAY		
10	TUESDAY		
11	WEDNESDAY	Tentative End Semester Examinations*	
12	THURSDAY		
13	FRIDAY		
14	SATURDAY	SECOND SATURDAY - HOLIDAY	
15	SUNDAY	HOLIDAY	
16	MONDAY		
17	TUESDAY		
18	WEDNESDAY		
19	THURSDAY		
20	FRIDAY		
21	SATURDAY		
22	SUNDAY	HOLIDAY	
23	MONDAY		
24	TUESDAY		
25	WEDNESDAY		
26	THURSDAY		
27	FRIDAY		
28	SATURDAY	FOURTH SATURDAY - HOLIDAY	
29	SUNDAY	HOLIDAY	
30	MONDAY		
31	TUESDAY		

 PRINCIPAL,
 K. S. R. INSTITUTE FOR
 ENGINEERING TECHNOLOGY,
 K. S. R. NAGAR,
 TIRUCHENGODE-637 215,
 NAMAKKAL DISTRICT, TAMIL NADU.

K S R INSTITUTE FOR ENGINEERING AND TECHNOLOGY TIRUCHENGODE – 637 215.

ACADEMIC SCHEDULE REVISED

ODD Semester (2016-17)

JUN 2016– DEC 2016

PROGRAMME: B.E/B.Tech Degree

SEMESTER: III, V & VII

PROGRAMME: M.E/M.Tech Degree

SEMESTER: III

S.No	Date(s)	Schedule
1.	04.07.2016	Commencement of Classes for 3 rd , 5 th & 7 th Semester B.E
2.	18.07.2016	Commencement of Classes for 3 rd Semester M.E
3.	13.08.2016	Completion of 2.5 Units for BE & ME (31 working days)
4.	16.08.2016 – 22.08.2016	<i>Internal Assessment Test I for all UG & PG Except I year (1.5 units)</i>
5.	16.09.2016	Completion of next 1.5 Units (24 working days)
6.	17.09.2016 – 23.09.2016	<i>Internal Assessment Test II for all UG & PG Except I year (1.5 units)</i>
7.	08.10.2016	Completion of next 1 Unit (18 working days)
8.	17.10.2016 – 24.10.2016	<i>Internal Assessment Test III for all UG & PG Except I year (2 units)</i>
9.	13.10.2016 – 15.10.2016	Commencement of University Practical Exams*(3days)
10.	26.10.2016	Last Instruction Day for B.E
11.	02.11.2016	Commencement of End Semester Examinations for BE
12.	08.11.2016	Last Instruction Day for M.E
13.	14.11.2016	Commencement of End Semester Examinations for ME
14.	26.12.2016	Reopening for next semester

*Subjected to Change

No. of Workings Days: 84

 PRINCIPAL

 PRINCIPAL
 K. S. R. INSTITUTE FOR
 ENGINEERING AND TECHNOLOGY
 K. S. R. KALVENAGAR,
 TIRUCHENGODE-637 215,
 NARAYAL G, TAMIL NADU.

ACADEMIC SCHEDULE

JUNE 2016

Date	Day	Particulars	No. of Working Days
1	WEDNESDAY		
2	THURSDAY		
3	FRIDAY		
4	SATURDAY		
5	SUNDAY	HOLIDAY	
6	MONDAY		
7	TUESDAY		
8	WEDNESDAY		
9	THURSDAY		
10	FRIDAY		
11	SATURDAY	SECOND SATURDAY - HOLIDAY	
12	SUNDAY	HOLIDAY	
13	MONDAY		
14	TUESDAY		
15	WEDNESDAY		
16	THURSDAY		
17	FRIDAY		
18	SATURDAY		
19	SUNDAY	HOLIDAY	
20	MONDAY		
21	TUESDAY		
22	WEDNESDAY		
23	THURSDAY		
24	FRIDAY		
25	SATURDAY	FOURTH SATURDAY - HOLIDAY	
26	SUNDAY	HOLIDAY	
27	MONDAY		
28	TUESDAY		
29	WEDNESDAY		
30	THURSDAY		

JULY 2016

Date	Day	Particulars	No. of Working Days
1	FRIDAY		
2	SATURDAY		
3	SUNDAY	HOLIDAY	
4	MONDAY	Commencement of Theory Classes for 3 rd 5 th & 7 th Sem B.E	1
5	TUESDAY		2
6	WEDNESDAY		3
7	THURSDAY	RAMZAN -HOLIDAY	
8	FRIDAY		4
9	SATURDAY	SECOND SATURDAY- HOLIDAY	
10	SUNDAY	HOLIDAY	
11	MONDAY		5
12	TUESDAY		6
13	WEDNESDAY		7
14	THURSDAY		8
15	FRIDAY		9
16	SATURDAY		10
17	SUNDAY	HOLIDAY	
18	MONDAY	Commencement of theory Classes for 3 rd Sem M.E	11
19	TUESDAY		12
20	WEDNESDAY		13
21	THURSDAY		14
22	FRIDAY		15
23	SATURDAY	FOURTH SATURDAY - HOLIDAY	
24	SUNDAY	HOLIDAY	
25	MONDAY		16
26	TUESDAY		17
27	WEDNESDAY		18
28	THURSDAY		19
29	FRIDAY		20
30	SATURDAY		21
31	SUNDAY	HOLIDAY	

 PRINCIPAL,
 K. S. N. INSTITUTE FOR
 ENGINEERING AND TECHNOLOGY,
 K. S. R. KALVINADAR,
 TIRUCHENGODE-637 215,
 NAMAKKAL DI, TAMIL NADU.

AUGUST 2016

Date	Day	Particulars	No. of Working Days
1	MONDAY	HOLIDAY	
2	TUESDAY	ADI PERUKU-HOLIDAY	
3	WEDNESDAY		22
4	THURSDAY		23
5	FRIDAY		24
6	SATURDAY		25
7	SUNDAY	HOLIDAY	
8	MONDAY		26
9	TUESDAY		27
10	WEDNESDAY		28
11	THURSDAY		29
12	FRIDAY		30
13	SATURDAY	Compensation for 01.08.16 - MONDAY ORDER	31
14	SUNDAY	HOLIDAY	
15	MONDAY	INDEPENDENCE DAY - HOLIDAY	
16	TUESDAY	Internal Assessment- I S1	32
17	WEDNESDAY	S2	33
18	THURSDAY	S3	34
19	FRIDAY	S4	35
20	SATURDAY	S5	36
21	SUNDAY	HOLIDAY	
22	MONDAY	S6	37
23	TUESDAY		38
24	WEDNESDAY		39
25	THURSDAY	KRISHNA JAYANTHI - HOLIDAY	
26	FRIDAY		40
27	SATURDAY	Compensation for 02.08.16 - TUESDAY ORDER	41
28	SUNDAY	HOLIDAY	
29	MONDAY		42
30	TUESDAY		43
31	WEDNESDAY		44

SEPTEMBER 2016

Date	Day	Particulars	No. of Working Days
1	THURSDAY		45
2	FRIDAY		46
3	SATURDAY		47
4	SUNDAY	HOLIDAY	
5	MONDAY	VINAYAKAR CHATHURTHI - HOLIDAY	
6	TUESDAY		48
7	WEDNESDAY		49
8	THURSDAY		50
9	FRIDAY		51
10	SATURDAY	Compensation for 12.09.16 - MONDAY ORDER	52
11	SUNDAY	HOLIDAY	
12	MONDAY	HOLIDAY	
13	TUESDAY	BAKRID - HOLIDAY	
14	WEDNESDAY		53
15	THURSDAY		54
16	FRIDAY		55
17	SATURDAY	Internal Assessment- II S1	56
18	SUNDAY	HOLIDAY	
19	MONDAY	S2	57
20	TUESDAY	S3	58
21	WEDNESDAY	S4	59
22	THURSDAY	S5	60
23	FRIDAY	S6	61
24	SATURDAY	FOURTH SATURDAY - HOLIDAY	
25	SUNDAY	HOLIDAY	
26	MONDAY		62
27	TUESDAY		63
28	WEDNESDAY		64
29	THURSDAY		65
30	FRIDAY		66

PRINCIPAL.
K. S. R. INSTITUTE FOR
ENGINEERING AND TECHNOLOGY,
K. S. R. KALVI NAGAR,
TIRUCHENGODE-637 215,
NAMAKKAL DL, TAMIL NADU.

OCTOBER 2016

Date	Day	Particulars	No. of Working Days
1	SATURDAY		67
2	SUNDAY	HOLIDAY GANDHI JAYANTHI - HOLIDAY	
3	MONDAY		68
4	TUESDAY		69
5	WEDNESDAY		70
6	THURSDAY		71
7	FRIDAY		72
8	SATURDAY	Compensation for 28.10.16 - FRIDAY ORDER	73
9	SUNDAY	HOLIDAY	
10	MONDAY	SARASWATHI POOJA - HOLIDAY	
11	TUESDAY	VIJAYA DASAMI - HOLIDAY	
12	WEDNESDAY	MOHARRAM* - HOLIDAY	
13	THURSDAY	University End Sem Practical Examinations for BE*	74
14	FRIDAY		75
15	SATURDAY		76
16	SUNDAY	HOLIDAY	
17	MONDAY	Internal Assessment- III S1	77
18	TUESDAY	S2	78
19	WEDNESDAY	S3	79
20	THURSDAY	S4	80
21	FRIDAY	S5	81
22	SATURDAY	FOURTH SATURDAY - HOLIDAY	
23	SUNDAY	HOLIDAY	
24	MONDAY	S6	82
25	TUESDAY		83
26	WEDNESDAY	Last Instruction Day for BE	84
27	THURSDAY		
28	FRIDAY	HOLIDAY	
29	SATURDAY	DEEPAVALI - HOLIDAY	
30	SUNDAY	HOLIDAY	
31	MONDAY		

*Subjected to change

NOVEMBER 2016

Date	Day	Particulars	No. of Working Days
1	TUESDAY		
2	WEDNESDAY	University End Sem Examinations for BE	
3	THURSDAY		
4	FRIDAY		
5	SATURDAY		
6	SUNDAY	HOLIDAY	
7	MONDAY		
8	TUESDAY	Last Instruction Day for ME	
9	WEDNESDAY		
10	THURSDAY		
11	FRIDAY		
12	SATURDAY	SECOND SATURDAY - HOLIDAY	
13	SUNDAY	HOLIDAY	
14	MONDAY	University End Sem Examinations for ME	
15	TUESDAY		
16	WEDNESDAY		
17	THURSDAY		
18	FRIDAY		
19	SATURDAY		
20	SUNDAY	HOLIDAY	
21	MONDAY		
22	TUESDAY		
23	WEDNESDAY		
24	THURSDAY		
25	FRIDAY		
26	SATURDAY	FOURTH SATURDAY - HOLIDAY	
27	SUNDAY	HOLIDAY	
28	MONDAY		
29	TUESDAY		
30	WEDNESDAY		

PRINCIPAL
K. S. R.
ENGINEER
K. S. R.
TIRUCHENGODE-637 215,
NAMAKKAL Dt. TAMIL NADU.

K S R INSTITUTE FOR ENGINEERING AND TECHNOLOGY TIRUCHENGODE – 637 215.

ACADEMIC SCHEDULE

ODD Semester (2016-17)

JUL 2016– DEC 2016

PROGRAMME: B.E/B.Tech Degree

SEMESTER: I

S.No	Date(s)	Schedule
1.	03.08.2016	Commencement of Theory Classes for 1 st Semester B.E
2.	16.09.2016	Completion of 2.5 Units for BE (34 working days)
3.	17.09.2016 – 23.09.2016	Internal Assessment Test I for 1 year UG (1.5 units)
4.	14.10.2016	Completion of next 1.5 Units (20 working days)
5.	15.10.2016 – 21.10.2016	Internal Assessment Test II for 1 year UG (1.5 units)
6.	05.11.2016	Completion of next 1 Unit (16 working days)
7.	14.11.2016 – 19.11.2016	Internal Assessment Test III for 1 year UG (2 units)
8.	07.11.2016 – 11.11.2016	University End Semester Practical Exams*(5 days)
9.	22.11.2016	Last Instruction Day for B.E
10.	28.11.2016	Commencement of End Semester Examinations for BE*
11.	26.12.2016	Reopening for next semester

*Subjected to Change

No. of Workings Days: 83

 29/12/16
 PRINCIPAL

 PRINCIPAL
 K. S. R. INSTITUTE FOR
 ENGINEERING AND TECHNOLOGY,
 K. S. R. KALVI NAGAR,
 TIRUCHENGODE-637 215,
 NAMAKKAL DI, TAMIL NADU.

ACADEMIC SCHEDULE

AUGUST 2016

Date	Day	Particulars	No. of Working Days
1	MONDAY	HOLIDAY	
2	TUESDAY	ADI PERUKU- HOLIDAY	
3	WEDNESDAY	Commencement of Theory Classes for 1 st Sem B.E	1
4	THURSDAY		2
5	FRIDAY		3
6	SATURDAY		4
7	SUNDAY	HOLIDAY	
8	MONDAY		5
	TUESDAY		6
10	WEDNESDAY		7
11	THURSDAY		8
12	FRIDAY		9
13	SATURDAY	Compensation for 01.08.16 - MONDAY ORDER	10
14	SUNDAY	HOLIDAY	
15	MONDAY	INDEPENDENCE DAY - HOLIDAY	
16	TUESDAY		11
17	WEDNESDAY		12
18	THURSDAY		13
19	FRIDAY		14
20	SATURDAY		15
21	SUNDAY	HOLIDAY	
22	MONDAY		16
23	TUESDAY		17
24	WEDNESDAY		18
25	THURSDAY	KRISHNA JAYANTHI - HOLIDAY	
26	FRIDAY		19
27	SATURDAY	Compensation for 02.08.16 - TUESDAY ORDER	20
28	SUNDAY	HOLIDAY	
29	MONDAY		21
30	TUESDAY		22
31	WEDNESDAY		23

SEPTEMBER 2016

Date	Day	Particulars	No. of Working Days
1	THURSDAY		24
2	FRIDAY		25
3	SATURDAY		26
4	SUNDAY	HOLIDAY	
5	MONDAY	VINAYAKAR CHATHURTHI - HOLIDAY	
6	TUESDAY		27
7	WEDNESDAY		28
8	THURSDAY		29
9	FRIDAY		30
10	SATURDAY	Compensation for 12.09.16 - MONDAY ORDER	31
11	SUNDAY	HOLIDAY	
12	MONDAY	HOLIDAY	
13	TUESDAY	BAKRID - HOLIDAY	
14	WEDNESDAY		32
15	THURSDAY		33
16	FRIDAY		34
17	SATURDAY	Internal Assessment- 1 S1	35
18	SUNDAY	HOLIDAY	
19	MONDAY	S2	36
20	TUESDAY	S3	37
21	WEDNESDAY	S4	38
22	THURSDAY	S5	39
23	FRIDAY	S6	40
24	SATURDAY	FOURTH SATURDAY - HOLIDAY	
25	SUNDAY	HOLIDAY	
26	MONDAY		41
27	TUESDAY		42
28	WEDNESDAY		43
29	THURSDAY		44
30	FRIDAY		45

PRINCIPAL,
 K. S. R. INSTITUTE FOR
 ENGINEERING AND TECHNOLOGY,
 K. S. R. KALYANAGAR,
 TIRUCHENGODE-637 215,
 NAMAKKAL DI, TAMIL NADU.

OCTOBER 2016

Date	Day	Particulars	No. of Working Days
1	SATURDAY		46
2	SUNDAY	HOLIDAY GANDHI JAYANTHI - HOLIDAY	
3	MONDAY		47
4	TUESDAY		48
5	WEDNESDAY		49
6	THURSDAY		50
7	FRIDAY		51
8	SATURDAY	Compensation for 28.10.16 - FRIDAY ORDER	52
9	SUNDAY	HOLIDAY	
10	MONDAY	SARASWATHI POOJA - HOLIDAY	
11	TUESDAY	VIJAYA DASAMI - HOLIDAY	
12	WEDNESDAY	MOHARRAM* - HOLIDAY	
13	THURSDAY		53
14	FRIDAY		54
15	SATURDAY	Internal Assessment- II S1	55
16	SUNDAY	HOLIDAY	
17	MONDAY	S2	56
18	TUESDAY	S3	57
19	WEDNESDAY	S4	58
20	THURSDAY	S5	59
21	FRIDAY	S6	60
22	SATURDAY	FOURTH SATURDAY - HOLIDAY	
23	SUNDAY	HOLIDAY	
24	MONDAY		61
25	TUESDAY		62
26	WEDNESDAY		63
27	THURSDAY		64
28	FRIDAY	HOLIDAY	
29	SATURDAY	DEEPAVALI - HOLIDAY	
30	SUNDAY	HOLIDAY	
31	MONDAY		65

*Subjected to change

NOVEMBER 2016

Date	Day	Particulars	No. of Working Days
1	TUESDAY		66
2	WEDNESDAY		67
3	THURSDAY		68
4	FRIDAY		69
5	SATURDAY		70
6	SUNDAY	HOLIDAY	
7	MONDAY	University End Sem Practical Examinations for BE*	71
8	TUESDAY		72
9	WEDNESDAY		73
10	THURSDAY		74
11	FRIDAY		75
12	SATURDAY	SECOND SATURDAY- HOLIDAY	
13	SUNDAY	HOLIDAY	
14	MONDAY	Internal Assessment- III S1	76
15	TUESDAY	S2	77
16	WEDNESDAY	S3	78
17	THURSDAY	S4	79
18	FRIDAY	S5	80
19	SATURDAY	S6	81
20	SUNDAY	HOLIDAY	
21	MONDAY		82
22	TUESDAY	Last Instruction Day	83
23	WEDNESDAY		
24	THURSDAY		
25	FRIDAY		
26	SATURDAY	FOURTH SATURDAY - HOLIDAY	
27	SUNDAY	HOLIDAY	
28	MONDAY	University End Sem Examinations for 1 st BE	
29	TUESDAY		
30	WEDNESDAY		

 PRINCIPAL,
 K. S. R. INSTITUTE FOR
 ENGINEERING AND TECHNOLOGY,
 K. S. R. KALVI NAGAR,
 TIRUCHENGODE-637 215,
 NAMAKKAL DL. TAMIL NADU.

DECEMBER 2016

Date	Day	Particulars	No. of Working Days
1	THURSDAY		
2	FRIDAY		
3	SATURDAY		
4	SUNDAY	HOLIDAY	
5	MONDAY		
6	TUESDAY		
7	WEDNESDAY		
8	THURSDAY		
9	FRIDAY		
10	SATURDAY	SECOND SATURDAY-HOLIDAY	
11	SUNDAY	HOLIDAY	
12	MONDAY		
13	TUESDAY	MILADI NABI - HOLIDAY	
14	WEDNESDAY		
15	THURSDAY		
16	FRIDAY		
17	SATURDAY		
18	SUNDAY	HOLIDAY	
19	MONDAY		
20	TUESDAY		
21	WEDNESDAY		
22	THURSDAY		
23	FRIDAY		
24	SATURDAY	FOURTH SATURDAY - HOLIDAY	
25	SUNDAY	HOLIDAY - CHRISTMAS	
26	MONDAY	Reopening for next semester	
27	TUESDAY		
28	WEDNESDAY		
29	THURSDAY		
30	FRIDAY		
31	SATURDAY	HOLIDAY	

JANUARY 2017

Date	Day	Particulars	No. of Working Days
1	SUNDAY	HOLIDAY	
2	MONDAY		
3	TUESDAY		
4	WEDNESDAY		
5	THURSDAY		
6	FRIDAY		
7	SATURDAY		
8	SUNDAY	HOLIDAY	
9	MONDAY		
10	TUESDAY		
11	WEDNESDAY		
12	THURSDAY		
13	FRIDAY	BOGI - HOLIDAY	
14	SATURDAY	PONGAL - HOLIDAY	
15	SUNDAY	THIRUVALLUVAR DAY- HOLIDAY	
16	MONDAY	UZHAVARTHIRUNAL - HOLIDAY	
17	TUESDAY		
18	WEDNESDAY		
19	THURSDAY		
20	FRIDAY		
21	SATURDAY		
22	SUNDAY	HOLIDAY	
23	MONDAY		
24	TUESDAY		
25	WEDNESDAY		
26	THURSDAY	REPUBLIC DAY - HOLIDAY	
27	FRIDAY		
28	SATURDAY	Compensation for 13.01.17 - FRIDAY ORDER	
29	SUNDAY	HOLIDAY	
30	MONDAY		
31	TUESDAY		

*Subjected to change

ANNA UNIVERSITY
INSTITUTE FOR
TECHNOLOGY,
9, RAJIV NAGAR,
CHENGODE-637 215,
RAMAKKAL DI, TAMIL NADU.

K S R INSTITUTE FOR ENGINEERING AND TECHNOLOGY TIRUCHENGODE – 637 215.

ACADEMIC SCHEDULE

ODD Semester (2016-17)

AUG 2016– DEC 2016

PROGRAMME: M.E/M.Tech Degree

SEMESTER: I

S.No	Date(s)	Schedule
1.	22.08.2016	Commencement of Theory Classes for 1 st Semester M.E
2.	05.10.2016	Completion of 2.5 Units for ME (34 working days)
3.	06.10.2016 – 15.10.2016	Internal Assessment Test I for 1 year PG (1.5 units)
4.	04.11.2016	Completion of next 1.5 Units (20 working days)
5.	05.11.2016 – 11.11.2016	Internal Assessment Test II for 1 year PG (1.5 units)
6.	30.11.2016	Completion of next 1 Unit (20 working days)
7.	01.12.2016 – 07.12.2016	Internal Assessment Test III for 1 year PG (2 units)
8.	08.12.2016 - 09.12.2016	University End Semester Practical Exams*(2 days)
9.	13.12.2016	Last Instruction Day for M.E
10.	19.12.2016	Commencement of End Semester Examinations for ME*
11.	23.01.2017	Reopening for next semester

*Subjected to Change

No. of Workings Days: 83



29/12/16
PRINCIPAL



PRINCIPAL
K S R INSTITUTE FOR
ENGINEERING AND TECHNOLOGY
K. S. M. BALVINADAR,
TIRUCHENGODE-637 215,
NAMAKKAL DI, TAMIL NADU.

ACADEMIC SCHEDULE

AUGUST 2016

SEPTEMBER 2016

Date	Day	Particulars	No. of Working Days
1	MONDAY	HOLIDAY	
2	TUESDAY	ADI PERUKU- HOLIDAY	
3	WEDNESDAY		
4	THURSDAY		
5	FRIDAY		
6	SATURDAY		
7	SUNDAY	HOLIDAY	
8	MONDAY		
9	TUESDAY		
10	WEDNESDAY		
11	THURSDAY		
12	FRIDAY		
13	SATURDAY	Compensation for 01.08.16 - MONDAY ORDER	
14	SUNDAY	HOLIDAY	
15	MONDAY	INDEPENDENCE DAY - HOLIDAY	
16	TUESDAY		
17	WEDNESDAY		
18	THURSDAY		
19	FRIDAY		
20	SATURDAY		
21	SUNDAY	HOLIDAY	
22	MONDAY	Commencement of Theory Classes for 1 st Sem M.E	1
23	TUESDAY		2
24	WEDNESDAY		3
25	THURSDAY	KRISHNA JAYANTHI - HOLIDAY	
26	FRIDAY		4
27	SATURDAY	Compensation for 02.08.16 - TUESDAY ORDER	5
28	SUNDAY	HOLIDAY	
29	MONDAY		6
30	TUESDAY		7
31	WEDNESDAY		8

Date	Day	Particulars	No. of Working Days
1	THURSDAY		9
2	FRIDAY		10
3	SATURDAY		11
4	SUNDAY	HOLIDAY	
5	MONDAY	VINAYAKAR CHATHURTHI - HOLIDAY	
6	TUESDAY		12
7	WEDNESDAY		13
8	THURSDAY		14
9	FRIDAY		15
10	SATURDAY	Compensation for 12.09.16 - MONDAY ORDER	16
11	SUNDAY	HOLIDAY	
12	MONDAY	HOLIDAY	
13	TUESDAY	BAKRID - HOLIDAY	
14	WEDNESDAY		17
15	THURSDAY		18
16	FRIDAY		19
17	SATURDAY		20
18	SUNDAY	HOLIDAY	
19	MONDAY		21
20	TUESDAY		22
21	WEDNESDAY		23
22	THURSDAY		24
23	FRIDAY		25
24	SATURDAY	FOURTH SATURDAY - HOLIDAY	
25	SUNDAY	HOLIDAY	
26	MONDAY		26
27	TUESDAY		27
28	WEDNESDAY		28
29	THURSDAY		29
30	FRIDAY		30

 PRINCIPAL,
 K. S. R. INSTITUTE FOR
 ENGINEERING TECHNOLOGY,
 K. S. R. NAGAR,
 TIRUCHENGODE-617 215,
 NAMAKKAL DL, TAMIL NADU.

OCTOBER 2016

Date	Day	Particulars	No. of Working Days
1	SATURDAY		31
2	SUNDAY	HOLIDAY GANDHI JAYANTHI - HOLIDAY	
3	MONDAY		32
4	TUESDAY		33
5	WEDNESDAY		34
6	THURSDAY	Internal Assessment- I S1	35
7	FRIDAY	S2	36
8	SATURDAY	S3-Compensation for 28.10.16 - FRIDAY ORDER	37
9	SUNDAY	HOLIDAY	
10	MONDAY	SARASWATHI POOJA - HOLIDAY	
11	TUESDAY	VIJAYA DASAMI - HOLIDAY	
12	WEDNESDAY	MOHARRAM* - HOLIDAY	
13	THURSDAY	S4	38
14	FRIDAY	S5	39
15	SATURDAY	S6	40
16	SUNDAY	HOLIDAY	
17	MONDAY		41
18	TUESDAY		42
19	WEDNESDAY		43
20	THURSDAY		44
21	FRIDAY		45
22	SATURDAY	FOURTH SATURDAY - HOLIDAY	
23	SUNDAY	HOLIDAY	
24	MONDAY		46
25	TUESDAY		47
26	WEDNESDAY		48
27	THURSDAY		49
28	FRIDAY	HOLIDAY	
29	SATURDAY	DEEPAVALI - HOLIDAY	
30	SUNDAY	HOLIDAY	
31	MONDAY		50

*Subjected to change

NOVEMBER 2016

Date	Day	Particulars	No. of Working Days
1	TUESDAY		51
2	WEDNESDAY		52
3	THURSDAY		53
4	FRIDAY		54
5	SATURDAY	Internal Assessment- II S1	55
6	SUNDAY	HOLIDAY	
7	MONDAY	S2	56
8	TUESDAY	S3	57
9	WEDNESDAY	S4	58
10	THURSDAY	S5	59
11	FRIDAY	S6	60
12	SATURDAY	SECOND SATURDAY - HOLIDAY	
13	SUNDAY	HOLIDAY	
14	MONDAY		61
15	TUESDAY		62
16	WEDNESDAY		63
17	THURSDAY		64
18	FRIDAY		65
19	SATURDAY		66
20	SUNDAY	HOLIDAY	
21	MONDAY		67
22	TUESDAY		68
23	WEDNESDAY		69
24	THURSDAY		70
25	FRIDAY		71
26	SATURDAY	FOURTH SATURDAY - HOLIDAY	
27	SUNDAY	HOLIDAY	
28	MONDAY		72
29	TUESDAY		73
30	WEDNESDAY		74



PRINCIPAL,
K. S. R. INSTITUTE FOR
ENGINEERING AND TECHNOLOGY,
K. S. R. KALVI NAGAR,
TIRUCHENGODE-637 215,
NAMAKKAL DL, TAMIL NADU.

DECEMBER 2016

Date	Day	Particulars	No. of Working Days
1	THURSDAY	Internal Assessment- III SI	75
2	FRIDAY	S2	76
3	SATURDAY	S3	77
4	SUNDAY	HOLIDAY	
5	MONDAY	S4	78
6	TUESDAY	S5	79
7	WEDNESDAY	S6	80
8	THURSDAY	University End Sem Practical Examinations for BE*	81
9	FRIDAY		82
10	SATURDAY	SECOND SATURDAY- HOLIDAY	
11	SUNDAY	HOLIDAY	
12	MONDAY	Last Instruction Day	83
13	TUESDAY	MILADI NABI - HOLIDAY	
14	WEDNESDAY		
15	THURSDAY		
16	FRIDAY		
17	SATURDAY		
18	SUNDAY	HOLIDAY	
19	MONDAY	University End Sem Examinations for I st ME	
20	TUESDAY		
21	WEDNESDAY		
22	THURSDAY		
23	FRIDAY		
24	SATURDAY	FOURTH SATURDAY - HOLIDAY	
25	SUNDAY	HOLIDAY - CHRISTMAS	
26	MONDAY		
27	TUESDAY		
28	WEDNESDAY		
29	THURSDAY		
30	FRIDAY		
31	SATURDAY	HOLIDAY	

JANUARY 2017

Date	Day	Particulars	No. of Working Days
1	SUNDAY	HOLIDAY	
2	MONDAY		
3	TUESDAY		
4	WEDNESDAY		
5	THURSDAY		
6	FRIDAY		
7	SATURDAY		
8	SUNDAY	HOLIDAY	
9	MONDAY		
10	TUESDAY		
11	WEDNESDAY		
12	THURSDAY		
13	FRIDAY	BOGI - HOLIDAY	
14	SATURDAY	PONGAL - HOLIDAY	
15	SUNDAY	THIRUVALLUVAR DAY- HOLIDAY	
16	MONDAY	UZHAVARTHIRUNAL - HOLIDAY	
17	TUESDAY		
18	WEDNESDAY		
19	THURSDAY		
20	FRIDAY		
21	SATURDAY		
22	SUNDAY	HOLIDAY	
23	MONDAY	Reopening for next semester	
24	TUESDAY		
25	WEDNESDAY		
26	THURSDAY	REPUBLIC DAY - HOLIDAY	
27	FRIDAY		
28	SATURDAY	Compensation for 13.01.17 - FRIDAY ORDER	
29	SUNDAY	HOLIDAY	
30	MONDAY		
31	TUESDAY		

*Subjected to change

 PRINCIPAL,
 K. S. R. INSTITUTE FOR
 ENGINEERING AND TECHNOLOGY,
 K. S. R. ROAD,
 TIRUCHENGODE-637 215,
 NALLAKKAL DI, TAMIL NADU.

ACADEMIC SCHEDULE

Even Semester (2016-17)

DEC 2016 – MAY 2017

PROGRAMME: B.E/B.Tech Degree

SEMESTER: II, IV & VI sem

S.No	Date(s)	Schedule
1.	04.01.2017	Commencement of Theory Classes for 2 nd , 4 th and 6 th semester BE/B.Tech
2.	16.02.2017	Completion of 2.5 Units for Final BE/B.Tech (34 working days)
3.	17.02.2017 – 24.02.2017	<i>Internal Assessment Test I for 2nd, 4th and 6th semester BE/B.Tech (1.5 units)</i>
4.	17.03.2017	Completion of next 1.5 units (22 working days)
5.	18.03.2017 – 24.03.2017	<i>Internal Assessment Test II for 2nd, 4th and 6th semester BE/B.Tech (1.5 units)</i>
6.	15.04.2017	Completion of next 1 unit (18 working days)
7.	17.04.2017 – 22.04.2017	<i>Internal Assessment Test III for 2nd, 4th and 6th semester BE/B.Tech (2 units)</i>
8.	10.04.2017 – 13.04.2017	<i>Tentative University Practical Examinations**(4 days)</i>
9.	24.04.2017	Last Instruction Day for B.E
10.	27.04.2017	Commencement of End Semester Examinations for all BE/B.Tech*
11.	03.07.2017	Reopening for next semester

*Subjected to Change

No. of Workings Days: 85



PRINCIPAL,
K S R INSTITUTE FOR
ENGINEERING AND TECHNOLOGY,
K. S. R. KALVINAGAR,
TIRUCHENGODE-637 215,
NAMAKKAL Dt, TAMIL NADU.



PRINCIPAL

ACADEMIC SCHEDULE

DECEMBER 2016

Date	Day	Particulars	No. of Working Days
1	THURSDAY		
2	FRIDAY		
3	SATURDAY		
4	SUNDAY	HOLIDAY	
5	MONDAY		
6	TUESDAY		
7	WEDNESDAY		
8	THURSDAY		
9	FRIDAY		
10	SATURDAY	SECOND SATURDAY-HOLIDAY	
11	SUNDAY	HOLIDAY	
12	MONDAY		
13	TUESDAY	MILADI NABI - HOLIDAY	
14	WEDNESDAY		
15	THURSDAY		
16	FRIDAY		
17	SATURDAY		
18	SUNDAY	HOLIDAY	
19	MONDAY		
20	TUESDAY		
21	WEDNESDAY		
22	THURSDAY		
23	FRIDAY		
24	SATURDAY	FOURTH SATURDAY - HOLIDAY	
25	SUNDAY	HOLIDAY - CHRISTMAS	
26	MONDAY		
27	TUESDAY		
28	WEDNESDAY		
29	THURSDAY		
30	FRIDAY		
31	SATURDAY	HOLIDAY	

JANUARY 2017

Date	Day	Particulars	No. of Working Days
1	SUNDAY	HOLIDAY	
2	MONDAY		
3	TUESDAY		
4	WEDNESDAY	Commencement of Theory Classes for 2 nd , 4 th & 6 th Sem B.E.	1
5	THURSDAY		2
6	FRIDAY		3
7	SATURDAY		4
8	SUNDAY	HOLIDAY	
9	MONDAY		5
10	TUESDAY		6
11	WEDNESDAY		7
12	THURSDAY		8
13	FRIDAY	BOGI - HOLIDAY	
14	SATURDAY	PONGAL - HOLIDAY	
15	SUNDAY	THIRUVALLUVAR DAY- HOLIDAY	
16	MONDAY	UZHAVARTHIRUNAL - HOLIDAY	
17	TUESDAY		9
18	WEDNESDAY		10
19	THURSDAY		11
20	FRIDAY		12
21	SATURDAY		13
22	SUNDAY	HOLIDAY	
23	MONDAY		14
24	TUESDAY		15
25	WEDNESDAY		16
26	THURSDAY	REPUBLIC DAY - HOLIDAY	
27	FRIDAY		17
28	SATURDAY	Compensation for 13.01.17 - FRIDAY ORDER.	18
29	SUNDAY	HOLIDAY	
30	MONDAY		19
31	TUESDAY		20



 PRINCIPAL,
 K. S. R. INSTITUTE FOR
 ENGINEERING AND TECHNOLOGY,
 K. S. R. NAGAR,
 TIRUCHIURAI - 617 215,
 NAMAKAL DE, TAMIL NADU.

FEBRUARY 2017

Date	Day	Particulars	No. of Working Days
1	WEDNESDAY		21
2	THURSDAY		22
3	FRIDAY		23
4	SATURDAY		24
5	SUNDAY	HOLIDAY	
6	MONDAY		25
7	TUESDAY		26
8	WEDNESDAY		27
9	THURSDAY		28
10	FRIDAY		29
11	SATURDAY		30
12	SUNDAY	HOLIDAY	
13	MONDAY		31
14	TUESDAY		32
15	WEDNESDAY		33
16	THURSDAY		34
17	FRIDAY	Internal Assessment- I S1	35
18	SATURDAY	S2	36
19	SUNDAY	HOLIDAY	
20	MONDAY	Founder's Day*	
21	TUESDAY	S3	37
22	WEDNESDAY	S4	38
23	THURSDAY	S5	39
24	FRIDAY	S6	40
25	SATURDAY	FOURTH SATURDAY - HOLIDAY	
26	SUNDAY	HOLIDAY	
27	MONDAY		41
28	TUESDAY		42

MARCH 2017

Date	Day	Particulars	No. of Working Days
1	WEDNESDAY		43
2	THURSDAY		44
3	FRIDAY		45
4	SATURDAY		46
5	SUNDAY		
6	MONDAY		47
7	TUESDAY		48
8	WEDNESDAY		49
9	THURSDAY		50
10	FRIDAY		51
11	SATURDAY	SECOND SATURDAY - HOLIDAY	
12	SUNDAY	HOLIDAY	
13	MONDAY		52
14	TUESDAY		53
15	WEDNESDAY		54
16	THURSDAY		55
17	FRIDAY		56
18	SATURDAY	Internal Assessment- II S1	57
19	SUNDAY	HOLIDAY	
20	MONDAY	S2	58
21	TUESDAY	S3	59
22	WEDNESDAY	S4	60
23	THURSDAY	S5	61
24	FRIDAY	S6	62
25	SATURDAY	FOURTH SATURDAY - HOLIDAY	
26	SUNDAY	HOLIDAY	
27	MONDAY		63
28	TUESDAY		64
29	WEDNESDAY	TELUGU NEW YEAR - HOLIDAY	
30	THURSDAY		65
31	FRIDAY		66



 PRINCIPAL,
 K. S. R. INSTITUTE FOR
 ENGINEERING AND TECHNOLOGY,
 K. S. R. KALVI NAGAR,
 TIRUCHENGODE-637 215,
 NAMAKKAL DI, TAMIL NADU.

APRIL 2017

Date	Day	Particulars	No. of Working Days
1	SATURDAY		67
2	SUNDAY		
3	MONDAY		68
4	TUESDAY		69
5	WEDNESDAY		70
6	THURSDAY		71
7	FRIDAY		72
8	SATURDAY		73
9	SUNDAY	MAHAVEER JAYANTHI - HOLIDAY	
10	MONDAY	Tentative University Practical Examinations*	74
11	TUESDAY		75
12	WEDNESDAY		76
13	THURSDAY		77
14	FRIDAY	TAMIL NEW YEAR- Dr.AMBEDKAR BIRTHDAY - GOOD FRIDAY - HOLIDAY	
15	SATURDAY		78
16	SUNDAY	HOLIDAY	
17	MONDAY	Internal Assessment- III S1	79
18	TUESDAY	S2	80
19	WEDNESDAY	S3	81
20	THURSDAY	S4	82
21	FRIDAY	S5	83
22	SATURDAY	S6	84
23	SUNDAY	HOLIDAY	
24	MONDAY	Last Instruction Day	85
25	TUESDAY		
26	WEDNESDAY		
27	THURSDAY	University End Sem Examinations*	
28	FRIDAY		
29	SATURDAY		
30	SUNDAY		

MAY 2017

Date	Day	Particulars	No. of Working Days
1	MONDAY	MAY DAY- HOLIDAY	
2	TUESDAY		
3	WEDNESDAY		
4	THURSDAY		
5	FRIDAY		
6	SATURDAY		
7	SUNDAY	HOLIDAY	
8	MONDAY		
9	TUESDAY		
10	WEDNESDAY		
11	THURSDAY		
12	FRIDAY		
13	SATURDAY	SECOND SATURDAY - HOLIDAY	
14	SUNDAY	HOLIDAY	
15	MONDAY		
16	TUESDAY		
17	WEDNESDAY		
18	THURSDAY		
19	FRIDAY		
20	SATURDAY		
21	SUNDAY	HOLIDAY	
22	MONDAY		
23	TUESDAY		
24	WEDNESDAY		
25	THURSDAY		
26	FRIDAY		
27	SATURDAY	FOURTH SATURDAY - HOLIDAY	
28	SUNDAY	HOLIDAY	
29	MONDAY		
30	TUESDAY		
31	WEDNESDAY		

 PRINCIPAL,
 K. J. SOMAIYAS INSTITUTE FOR
 ENGINEERING AND TECHNOLOGY,
 K. J. SOMAIYAS NAGAR,
 TIRUPATI - 517 215,
 NARASIPETA DISTRICT, ANDHRA PRADESH, INDIA.

ACADEMIC SCHEDULE

Even Semester (2016-17)

DEC 2016 – MAY 2017

PROGRAMME: B.E/B.Tech Degree

SEMESTER: VIII sem

S.No	Date(s)	Schedule
1.	04.01.2017	Commencement of Theory Classes for 8 th semester BE/B.Tech
2.	18.01.2017	Completion of 2 Units for 8th Sem BE/B.Tech (10 working days)
3.	19.01.2017 – 23.01.2017	<i>Internal Assessment Test I for 8th semester BE/B.Tech (1.5 units)</i>
4.	31.01.2017	Completion of next 2 units (10 working days)
5.	01.02.2017 – 04.02.2017	<i>Internal Assessment Test II for 8th semester BE/B.Tech (1.5 units)</i>
6.	11.02.2017	Completion of next 1 unit (10 working days)
7.	13.02.2017 – 16.02.2017	<i>Internal Assessment Test III for 8th semester BE/B.Tech (2 units)</i>
8.	10.04.2017	<i>Tentative University Practical Examinations*</i>
9.	13.04.2017	Last Instruction Day for 8 th semester BE/B.Tech
10.	17.04.2017	Commencement of End Semester Examinations for 8 th sem BE/B.Tech*
11.	03.07.2017	Reopening for next semester

*Subjected to Change

No. of Workings Days: 77

PRINCIPAL

PRINCIPAL,
K. S. R. INSTITUTE FOR
ENGINEERING AND TECHNOLOGY,
K. S. R. KALVI NAGAR,
TIRUCHENGODE-637 215,
NAMAKKAL DL, TAMIL NADU.

ACADEMIC SCHEDULE

DECEMBER 2016

Date	Day	Particulars	No. of Working Days
1	THURSDAY		
2	FRIDAY		
3	SATURDAY		
4	SUNDAY	HOLIDAY	
5	MONDAY		
6	TUESDAY		
7	WEDNESDAY		
8	THURSDAY		
9	FRIDAY		
10	SATURDAY	SECOND SATURDAY-HOLIDAY	
11	SUNDAY	HOLIDAY	
12	MONDAY		
13	TUESDAY	MILADI NABI - HOLIDAY	
14	WEDNESDAY		
15	THURSDAY		
16	FRIDAY		
17	SATURDAY		
18	SUNDAY	HOLIDAY	
19	MONDAY		
20	TUESDAY		
21	WEDNESDAY		
22	THURSDAY		
23	FRIDAY		
24	SATURDAY	FOURTH SATURDAY - HOLIDAY	
25	SUNDAY	HOLIDAY - CHRISTMAS	
26	MONDAY		
27	TUESDAY		
28	WEDNESDAY		
29	THURSDAY		
30	FRIDAY		
31	SATURDAY	HOLIDAY	

JANUARY 2017

Date	Day	Particulars	No. of Working Days
1	SUNDAY	HOLIDAY	
2	MONDAY		
3	TUESDAY		
4	WEDNESDAY	Commencement of Theory Classes for 8 th Sem B.E	1
5	THURSDAY		2
6	FRIDAY		3
7	SATURDAY		4
8	SUNDAY	HOLIDAY	
9	MONDAY	REVIEW 0	5
10	TUESDAY		6
11	WEDNESDAY		7
12	THURSDAY		8
13	FRIDAY	BOGI - HOLIDAY	
14	SATURDAY	PONGAL - HOLIDAY	
15	SUNDAY	THIRUVALLUVAR DAY- HOLIDAY	
16	MONDAY	UZHAVARTHIRUNAL - HOLIDAY	
17	TUESDAY		9
18	WEDNESDAY		10
19	THURSDAY	Internal Assessment- I S1	11
20	FRIDAY	S2	12
21	SATURDAY	S3	13
22	SUNDAY	HOLIDAY	
23	MONDAY	S4	14
24	TUESDAY		15
25	WEDNESDAY		16
26	THURSDAY	REPUBLIC DAY - HOLIDAY	
27	FRIDAY	REVIEW 1	17
28	SATURDAY	Compensation for 13.01.17 - FRIDAY ORDER.	18
29	SUNDAY	HOLIDAY	
30	MONDAY		19
31	TUESDAY		20



 PRINCIPAL
 K. J. S. INSTITUTE FOR
 INFO AND TECHNOLOGY,
 K. R. KALMI NAGAR,
 TIRUCHENGODE-637 215,
 NAMAKKAL DISTRICT, TAMIL NADU.

FEBRUARY 2017

Date	Day	Particulars	No. of Working Days
1	WEDNESDAY	<i>Internal Assessment-II S1</i>	21
2	THURSDAY	<i>S2</i>	22
3	FRIDAY	<i>S3</i>	23
4	SATURDAY	<i>S4</i>	24
5	SUNDAY	HOLIDAY	
6	MONDAY		25
7	TUESDAY		26
8	WEDNESDAY		27
9	THURSDAY		28
10	FRIDAY		29
11	SATURDAY		30
12	SUNDAY	HOLIDAY	
13	MONDAY	<i>Internal Assessment-III S1</i>	31
14	TUESDAY	<i>S2</i>	32
15	WEDNESDAY	<i>S3</i>	33
16	THURSDAY	<i>S4</i>	34
17	FRIDAY		35
18	SATURDAY	<i>Review 2 & submission of 1 & 2 chapters</i>	36
19	SUNDAY	HOLIDAY	
20	MONDAY	<i>Founder's Day*</i>	
21	TUESDAY		37
22	WEDNESDAY		38
23	THURSDAY		39
24	FRIDAY		40
25	SATURDAY	<i>FOURTH SATURDAY - HOLIDAY</i>	
26	SUNDAY	HOLIDAY	
27	MONDAY		41
28	TUESDAY		42

MARCH 2017

Date	Day	Particulars	No. of Working Days
1	WEDNESDAY		43
2	THURSDAY		44
3	FRIDAY		45
4	SATURDAY		46
5	SUNDAY		
6	MONDAY		47
7	TUESDAY		48
8	WEDNESDAY		49
9	THURSDAY		50
10	FRIDAY	<i>Submission of 3 & 4 chapters</i>	51
11	SATURDAY	SECOND SATURDAY - HOLIDAY	
12	SUNDAY	HOLIDAY	
13	MONDAY		52
14	TUESDAY		53
15	WEDNESDAY		54
16	THURSDAY		55
17	FRIDAY		56
18	SATURDAY		57
19	SUNDAY	HOLIDAY	
20	MONDAY		58
21	TUESDAY		59
22	WEDNESDAY		60
23	THURSDAY		61
24	FRIDAY	<i>Project 100% Completed Demo & Project Report Submission rough copy</i>	62
25	SATURDAY	FOURTH SATURDAY - HOLIDAY	
26	SUNDAY	HOLIDAY	
27	MONDAY		63
28	TUESDAY		64
29	WEDNESDAY	TELUGU NEW YEAR - HOLIDAY	
30	THURSDAY		65
31	FRIDAY		66



PRINCIPAL,
K. S. R. INSTITUTE FOR
ENGINEERING AND TECHNOLOGY,
K. S. R. KALVINAGAR,
TIRUCHENPURI - 621 215,
NAMAKKAL DISTRICT, TAMIL NADU.

APRIL 2017

Date	Day	Particulars	No. of Working Days
1	SATURDAY		67
2	SUNDAY		
3	MONDAY	<i>PROJECT REPORT BONAFICATION & MODEL VIVA VOCE</i>	68
4	TUESDAY		69
5	WEDNESDAY		70
6	THURSDAY		71
7	FRIDAY		72
8	SATURDAY		73
9	SUNDAY	<i>MAHAVEER JAYANTHI - HOLIDAY</i>	
10	MONDAY	<i>Tentative University Practical Examinations*</i>	74
11	TUESDAY		75
12	WEDNESDAY		76
13	THURSDAY	<i>Last Instruction Day</i>	77
14	FRIDAY	<i>TAMIL NEW YEAR- Dr.AMBEDKAR BIRTHDAY - GOOD FRIDAY - HOLIDAY</i>	
15	SATURDAY		
16	SUNDAY	HOLIDAY	
17	MONDAY	<i>University End Sem Examinations*</i>	
18	TUESDAY		
19	WEDNESDAY		
20	THURSDAY		
21	FRIDAY		
22	SATURDAY		
23	SUNDAY	HOLIDAY	
24	MONDAY		
25	TUESDAY		
26	WEDNESDAY		
27	THURSDAY		
28	FRIDAY		
29	SATURDAY		
30	SUNDAY		

MAY 2017

Date	Day	Particulars	No. of Working Days
1	MONDAY	<i>MAY DAY - HOLIDAY</i>	
2	TUESDAY		
3	WEDNESDAY		
4	THURSDAY		
5	FRIDAY		
6	SATURDAY		
7	SUNDAY	HOLIDAY	
8	MONDAY		
9	TUESDAY		
10	WEDNESDAY		
11	THURSDAY		
12	FRIDAY		
13	SATURDAY	SECOND SATURDAY - HOLIDAY	
14	SUNDAY	HOLIDAY	
15	MONDAY		
16	TUESDAY		
17	WEDNESDAY		
18	THURSDAY		
19	FRIDAY		
20	SATURDAY		
21	SUNDAY	HOLIDAY	
22	MONDAY		
23	TUESDAY		
24	WEDNESDAY		
25	THURSDAY		
26	FRIDAY		
27	SATURDAY	FOURTH SATURDAY - HOLIDAY	
28	SUNDAY	HOLIDAY	
29	MONDAY		
30	TUESDAY		
31	WEDNESDAY		

 PRINCIPAL
 K. S. R. INSTITUTE FOR
 ENGINEERING AND TECHNOLOGY,
 K. S. R. KALVI NAGAR,
 TIRUCHENGODE-637 215,
 NAMAKKAL Dt. TAMIL NADU.

ACADEMIC SCHEDULE

Even Semester (2016-17)

DEC 2016 – MAY 2017

PROGRAMME: M.E/M.Tech Degree

SEMESTER: II & IV sem

S.No	Date(s)	Schedule
1.	23.01.2017	Commencement of Theory Classes for 2 nd and 4 th semester ME/M.Tech
2.	01.03.2017	Completion of 2.5 Units for ME/M.Tech (30 working days)
3.	02.03.2017 – 08.03.2017	<i>Internal Assessment Test I for 2nd semester ME/M.Tech (1.5 units)</i>
4.	24.03.2017	Completion of next 1 units (19 working days)
5.	27.03.2017 – 03.04.2017	<i>Internal Assessment Test II for 2nd semester ME/M.Tech (1.5 units)</i>
6.	22.04.2017	Completion of next 1.5 units (22 working days)
7.	24.04.2017 – 29.04.2017	<i>Internal Assessment Test III for 2nd semester ME/M.Tech (2 units)</i>
8.	02.05.2017 – 04.05.2017	<i>Tentative University Practical Examinations** (3 days)</i>
9.	05.05.2017	Last Instruction Day for M.E
10.	10.05.2017	Commencement of End Semester Examinations for all ME/M.Tech*
11.	03.07.2017	Reopening for next semester

*Subjected to Change

No. of Workings Days: 81

PRINCIPAL

PRINCIPAL
K. S. R. INSTITUTE FOR
ENGINEERING AND TECHNOLOGY
K. S. R. KALVINAGAR,
TIRUCHENGODE-637 215,
NAMAKKAL DI, TAMIL NADU.

ACADEMIC SCHEDULE

DECEMBER 2016

Date	Day	Particulars	No. of Working Days
1	THURSDAY		
2	FRIDAY		
3	SATURDAY		
4	SUNDAY	HOLIDAY	
5	MONDAY		
6	TUESDAY		
7	WEDNESDAY		
8	THURSDAY		
9	FRIDAY		
10	SATURDAY	SECOND SATURDAY-HOLIDAY	
11	SUNDAY	HOLIDAY	
12	MONDAY		
13	TUESDAY	MILADI NABI - HOLIDAY	
14	WEDNESDAY		
15	THURSDAY		
16	FRIDAY		
17	SATURDAY		
18	SUNDAY	HOLIDAY	
19	MONDAY		
20	TUESDAY		
21	WEDNESDAY		
22	THURSDAY		
23	FRIDAY		
24	SATURDAY	FOURTH SATURDAY - HOLIDAY	
25	SUNDAY	HOLIDAY - CHRISTMAS	
26	MONDAY		
27	TUESDAY		
28	WEDNESDAY		
29	THURSDAY		
30	FRIDAY		
31	SATURDAY	HOLIDAY	

JANUARY 2017

Date	Day	Particulars	No. of Working Days
1	SUNDAY	HOLIDAY	
2	MONDAY		
3	TUESDAY		
4	WEDNESDAY		
5	THURSDAY		
6	FRIDAY		
7	SATURDAY		
8	SUNDAY	HOLIDAY	
9	MONDAY		
10	TUESDAY		
11	WEDNESDAY		
12	THURSDAY		
13	FRIDAY	BOGI - HOLIDAY	
14	SATURDAY	PONGAL - HOLIDAY	
15	SUNDAY	THIRUVALLUVAR DAY- HOLIDAY	
16	MONDAY	UZHAVARTHIRUNAL - HOLIDAY	
17	TUESDAY		
18	WEDNESDAY		
19	THURSDAY		
20	FRIDAY		
21	SATURDAY		
22	SUNDAY	HOLIDAY	
23	MONDAY	Commencement of Theory Classes for 2 nd & 4 th Sem M.E	1
24	TUESDAY		2
25	WEDNESDAY		3
26	THURSDAY	REPUBLIC DAY - HOLIDAY	
27	FRIDAY		4
28	SATURDAY	Compensation for 13.01.17 - FRIDAY ORDER.	5
29	SUNDAY	HOLIDAY	
30	MONDAY		6
31	TUESDAY		7

 PRINCIPAL,
 K. S. R. INSTITUTE FOR
 ENGINEERING AND TECHNOLOGY,
 K. S. R. KALVINAGAR,
 TIRUCHENGODE-637 215,
 NAMAKKAL DISTRICT, TAMIL NADU.

FEBRUARY 2017

MARCH 2017

Date	Day	Particulars	No. of Working Days
1	WEDNESDAY		8
2	THURSDAY		9
3	FRIDAY		10
4	SATURDAY		11
5	SUNDAY	HOLIDAY	
6	MONDAY		12
7	TUESDAY		13
8	WEDNESDAY		14
9	THURSDAY		15
10	FRIDAY		16
11	SATURDAY		17
12	SUNDAY	HOLIDAY	
13	MONDAY		18
14	TUESDAY		19
15	WEDNESDAY		20
16	THURSDAY		21
17	FRIDAY		22
18	SATURDAY		23
19	SUNDAY	HOLIDAY	
20	MONDAY	Founder's Day*	
21	TUESDAY		24
22	WEDNESDAY		25
23	THURSDAY		26
24	FRIDAY		27
25	SATURDAY	FOURTH SATURDAY - HOLIDAY	
26	SUNDAY	HOLIDAY	
27	MONDAY		28
28	TUESDAY		29

Date	Day	Particulars	No. of Working Days
1	WEDNESDAY		30
2	THURSDAY	Internal Assessment- I S1	31
3	FRIDAY	S2	32
4	SATURDAY	S3	33
5	SUNDAY		
6	MONDAY	S4	34
7	TUESDAY	S5	35
8	WEDNESDAY	S6	36
9	THURSDAY		37
10	FRIDAY		38
11	SATURDAY	SECOND SATURDAY - HOLIDAY	
12	SUNDAY	HOLIDAY	
13	MONDAY		39
14	TUESDAY		40
15	WEDNESDAY		41
16	THURSDAY		42
17	FRIDAY		43
18	SATURDAY		44
19	SUNDAY	HOLIDAY	
20	MONDAY		45
21	TUESDAY		46
22	WEDNESDAY		47
23	THURSDAY		48
24	FRIDAY		49
25	SATURDAY	FOURTH SATURDAY - HOLIDAY	
26	SUNDAY	HOLIDAY	
27	MONDAY	Internal Assessment- II S1	50
28	TUESDAY	S2	51
29	WEDNESDAY	TELUGU NEW YEAR - HOLIDAY	
30	THURSDAY	S3	52
31	FRIDAY	S4	53



PRINCIPAL,
 K. S. R. INSTITUTE FOR
 ENGINEERING AND TECHNOLOGY,
 K. S. R. KALVI NAGAR,
 TIRUCHENGODE-637 215,
 NAMAKKAL DI, TAMIL NADU.

APRIL 2017

Date	Day	Particulars	No. of Working Days
1	SATURDAY	S5	54
2	SUNDAY		
3	MONDAY	S6	55
4	TUESDAY		56
5	WEDNESDAY		57
6	THURSDAY		58
7	FRIDAY		59
8	SATURDAY		60
9	SUNDAY	MAHAVEER JAYANTHI - HOLIDAY	
10	MONDAY		61
11	TUESDAY		62
12	WEDNESDAY		63
13	THURSDAY		64
14	FRIDAY	TAMIL NEW YEAR- Dr.AMBEDKAR BIRTHDAY - GOOD FRIDAY - HOLIDAY	
15	SATURDAY		65
16	SUNDAY	HOLIDAY	
17	MONDAY		66
18	TUESDAY		67
19	WEDNESDAY		68
20	THURSDAY		69
21	FRIDAY		70
22	SATURDAY		71
23	SUNDAY	HOLIDAY	
24	MONDAY	Internal Assessment- III S1	72
25	TUESDAY	S2	73
26	WEDNESDAY	S3	74
27	THURSDAY	S4	75
28	FRIDAY	S5	76
29	SATURDAY	S6	77
30	SUNDAY		

MAY 2017

Date	Day	Particulars	No. of Working Days
1	MONDAY	MAY DAY - HOLIDAY	
2	TUESDAY	Tentative University Practical Examinations*	78
3	WEDNESDAY		79
4	THURSDAY		80
5	FRIDAY	Last Instruction Day	81
6	SATURDAY		
7	SUNDAY	HOLIDAY	
8	MONDAY		
9	TUESDAY		
10	WEDNESDAY	University End Sem Examinations*	
11	THURSDAY		
12	FRIDAY		
13	SATURDAY	SECOND SATURDAY - HOLIDAY	
14	SUNDAY	HOLIDAY	
15	MONDAY		
16	TUESDAY		
17	WEDNESDAY		
18	THURSDAY		
19	FRIDAY		
20	SATURDAY		
21	SUNDAY	HOLIDAY	
22	MONDAY		
23	TUESDAY		
24	WEDNESDAY		
25	THURSDAY		
26	FRIDAY		
27	SATURDAY	FOURTH SATURDAY - HOLIDAY	
28	SUNDAY	HOLIDAY	
29	MONDAY		
30	TUESDAY		
31	WEDNESDAY		

 PRINCIPAL,
 K S R INSTITUTE FOR
 ENGINEERING TECHNOLOGY,
 R. T. S. NAGAR,
 TIRUCHENGODE-637 215,
 NAMAKKAL Dt, TAMIL NADU.

ACADEMIC SCHEDULE REVISED

ODD Semester (2017-18)

JUL 2017– OCT 2017

PROGRAMME: B.E/B.Tech Degree

SEMESTER: III, V & VII

PROGRAMME: M.E/M.Tech Degree

SEMESTER: III

S.No	Date(s)	Schedule
1.	03.07.2017	Commencement of Theory Classes for 3 rd , 5 th & 7 th Semester B.E & M.E
2.	16.08.2017	Completion of 2.5 Units for BE & ME (33 working days)
3.	17.08.2017 – 23.08.2017	<i>Internal Assessment Test I for all UG & PG Except I year (1.5 Units)</i>
4.	13.09.2017	Completion of 1.5 Units (21 working days)
5.	14.09.2017 – 21.09.2017	<i>Internal Assessment Test II for all UG & PG Except I year (1.5 Units)</i>
6.	07.10.2017	Completion of 1 Unit (17 working days)
7.	09.10.2017 – 14.10.2017	<i>Internal Assessment Test III for all UG & PG Except I year (2 units)</i>
8.	21.10.2017	Last Instruction Day for B.E
9.	23.10.2017	Commencement of University Practical Exams
10.	30.10.2017	Commencement of End Semester Examinations for BE
11.	18.12.2017	Reopening for next semester

No. of Workings Days: 79

 K S R INSTITUTE FOR
 ENGINEERING AND TECHNOLOGY,
 K. S. R. INSTITUTE FOR
 TIRUCHENGODE-637 215,
 NAMAKKAL Dt., TAMIL NADU.

 26/09/17
 PRINCIPAL

ACADEMIC SCHEDULE

JULY 2017

AUGUST 2017

Date	Day	Particulars	No. of Working Days
1	SATURDAY		
2	SUNDAY	HOLIDAY	
3	MONDAY	Commencement of Theory Classes for 3 rd 5 th & 7 th Sem B.E & M.E	1
4	TUESDAY		2
5	WEDNESDAY		3
6	THURSDAY		4
7	FRIDAY		5
	SATURDAY	SECOND SATURDAY-HOLIDAY	
9	SUNDAY	HOLIDAY	
10	MONDAY		6
11	TUESDAY		7
12	WEDNESDAY		8
13	THURSDAY		9
14	FRIDAY		10
15	SATURDAY		11
16	SUNDAY	HOLIDAY	
17	MONDAY		12
18	TUESDAY		13
19	WEDNESDAY		14
20	THURSDAY		15
21	FRIDAY		16
22	SATURDAY	FOURTH SATURDAY - HOLIDAY	
23	SUNDAY	HOLIDAY	
24	MONDAY		17
25	TUESDAY		18
26	WEDNESDAY		19
27	THURSDAY		20
28	FRIDAY		21
29	SATURDAY		22
30	SUNDAY	HOLIDAY	
31	MONDAY		23

Date	Day	Particulars	No. of Working Days
1	TUESDAY		24
2	WEDNESDAY		25
3	THURSDAY	ADI PERUKU-HOLIDAY	
4	FRIDAY		26
5	SATURDAY		27
6	SUNDAY	HOLIDAY	
7	MONDAY		28
8	TUESDAY		29
9	WEDNESDAY		30
10	THURSDAY		31
11	FRIDAY		32
12	SATURDAY	SECOND SATURDAY-HOLIDAY	
13	SUNDAY	HOLIDAY	
14	MONDAY	KRISHNA JAYANTHI-HOLIDAY	
15	TUESDAY	INDEPENDENCE DAY - HOLIDAY	
16	WEDNESDAY		33
17	THURSDAY	Internal Assessment- I S1	34
18	FRIDAY	S2	35
19	SATURDAY	S3	36
20	SUNDAY	HOLIDAY	
21	MONDAY	S4	37
22	TUESDAY	S5	38
23	WEDNESDAY	S6	39
24	THURSDAY		40
25	FRIDAY	VINAYAKAR CHATHURTHI - HOLIDAY	
26	SATURDAY	FOURTH SATURDAY - HOLIDAY	
27	SUNDAY	HOLIDAY	
28	MONDAY		41
29	TUESDAY		42
30	WEDNESDAY		43
31	THURSDAY		44

 PRINCIPAL,
 K. S. R. INSTITUTE FOR
 ENGINEERING AND TECHNOLOGY,
 K. S. R. KALVI NAGAR,
 TIRUCHENGODE-637 215,
 NAMAKKAL DI, TAMIL NADU.

SEPTEMBER 2017

Date	Day	Particulars	No. of Working Days
	FRIDAY		45
	SATURDAY	BAKRID - HOLIDAY	
	SUNDAY	HOLIDAY	
	MONDAY		46
	TUESDAY		47
	WEDNESDAY		48
	THURSDAY		49
	FRIDAY		50
	SATURDAY		51
0	SUNDAY	HOLIDAY	
1	MONDAY		52
2	TUESDAY		53
3	WEDNESDAY		54
4	THURSDAY	Internal Assessment- II S1	55
5	FRIDAY	S2	56
6	SATURDAY	HOLIDAY	
7	SUNDAY	HOLIDAY	
8	MONDAY	S3	57
9	TUESDAY	S4	58
0	WEDNESDAY	S5	59
1	THURSDAY	S6	60
2	FRIDAY		61
3	SATURDAY		62
4	SUNDAY	HOLIDAY	
5	MONDAY		63
6	TUESDAY		64
7	WEDNESDAY		65
8	THURSDAY		66
9	FRIDAY	SARASWATHI POOJA - HOLIDAY	
0	SATURDAY	VIJAYA DASAMI - HOLIDAY	

*Subjected to change

OCTOBER 2017

Date	Day	Particulars	No. of Working Days
1	SUNDAY	MOHARRAM* - HOLIDAY	
2	MONDAY	GANDHI JAYANTHI - HOLIDAY	
3	TUESDAY		67
4	WEDNESDAY		68
5	THURSDAY		69
6	FRIDAY		70
7	SATURDAY		71
8	SUNDAY	HOLIDAY	
9	MONDAY	Internal Assessment- III S1	72
10	TUESDAY	S2	73
11	WEDNESDAY	S3	74
12	THURSDAY	S4	75
13	FRIDAY	S5	76
14	SATURDAY	S6 Compensation for 16.10.17(Monday order)	77
15	SUNDAY	HOLIDAY	
16	MONDAY	HOLIDAY	
17	TUESDAY	HOLIDAY	
18	WEDNESDAY	DEEPAVALI - HOLIDAY	
19	THURSDAY	HOLIDAY	
20	FRIDAY		78
21	SATURDAY	Compensation for 17.10.17(Tuesday order) Last Instruction Day	79
22	SUNDAY	HOLIDAY	
23	MONDAY	University practical Examinations*	
24	TUESDAY		
25	WEDNESDAY		
26	THURSDAY		
27	FRIDAY		
28	SATURDAY	FOURTH SATURDAY - HOLIDAY	
29	SUNDAY	HOLIDAY	
30	MONDAY	University End Sem Examinations for BE& ME	
31	TUESDAY		

 ENGINEERING COLLEGE FOR
 TECHNOLOGY,
 K. P. S. NAGAR,
 TIRUCHENGODE-637 215,
 NAMAKKAL Dt, TAMIL NADU.

ACADEMIC SCHEDULE REVISED

ODD Semester (2017-18)

AUG 2017– DEC 2017

PROGRAMME: B.E/B.Tech Degree

SEMESTER: I

PROGRAMME: M.E/M.Tech Degree

SEMESTER: I

S.No	Date(s)	Schedule
1.	01.09.2017	Commencement of Classes for 1 st Semester BE
2.	06.09.2017	Commencement of Classes for 1 st Semester ME
3.	21.10.2017	Completion of 2.5 Units for BE & ME (35 working days)
4.	23.10.2017 – 28.10.2017	<i>Internal Assessment Test I for I year BE & ME (1.5 units)</i>
5.	14.11.2017	Completion of 1Unit for BE & ME (18 working days)
6.	15.11.2017 – 22.11.2017	<i>Internal Assessment Test II for I year BE & ME (1.5units)</i>
7.	11.12.2017	Completion of 1.5 Units for BE & ME (21 working days)
8.	12.12.2017 - 18.12.2017	<i>Internal Assessment Test III for I year BE & ME (2 units)</i>
9.	20.12.2017	Last Instruction Day for B.E
10.	26.12.2017	Last Instruction Day for ME
11.	26.12.2017	Commencement of Practical Examinations for BE & ME
12.	02.01.2018	Commencement of End Semester Examinations for BE & ME
13.	22.01.2018	Reopening for next semester

*Subjected to Change

No. of Workings Days: 84



PRINCIPAL

K S R INSTITUTE FOR
ENGINEERING AND TECHNOLOGY,
K. S. R. NAGAR,
TIRUCHENGODE-637 215,
NAMAKKAL DL, TAMIL NADU.



PRINCIPAL

ACADEMIC SCHEDULE

AUGUST 2017

SEPTEMBER 2017

Date	Day	Particulars	No. of Working Days
1	TUESDAY		
2	WEDNESDAY		
3	THURSDAY	ADI PERUKU-HOLIDAY	
4	FRIDAY		
5	SATURDAY	Compensation for 03.08.17(Thursday order)	
6	SUNDAY	HOLIDAY	
7	MONDAY		
8	TUESDAY		
9	WEDNESDAY		
10	THURSDAY		
11	FRIDAY		
12	SATURDAY	HOLIDAY	
13	SUNDAY	HOLIDAY	
14	MONDAY	KRISHNA JAYANTHI - HOLIDAY	
15	TUESDAY	INDEPENDENCE DAY - HOLIDAY	
16	WEDNESDAY		
17	THURSDAY		
18	FRIDAY		
19	SATURDAY	HOLIDAY	
20	SUNDAY	HOLIDAY	
21	MONDAY		
22	TUESDAY		
23	WEDNESDAY		
24	THURSDAY		
25	FRIDAY	VINAYAKAR CHATHURTHI - HOLIDAY	
26	SATURDAY	HOLIDAY	
27	SUNDAY	HOLIDAY	
28	MONDAY		
29	TUESDAY		
30	WEDNESDAY		
31	THURSDAY		

Date	Day	Particulars	No. of Working Days
1	FRIDAY	Commencement of Theory Classes for 1 st Sem B.E	1
2	SATURDAY	BAKRID - HOLIDAY	
3	SUNDAY	HOLIDAY	
4	MONDAY		2
5	TUESDAY		3
6	WEDNESDAY	Commencement of Theory Classes for 1 st Sem M.E	4
7	THURSDAY		5
8	FRIDAY		6
9	SATURDAY		7
10	SUNDAY	HOLIDAY	
11	MONDAY		8
12	TUESDAY		9
13	WEDNESDAY		10
14	THURSDAY		11
15	FRIDAY		12
16	SATURDAY	HOLIDAY	
17	SUNDAY	HOLIDAY	
18	MONDAY		13
19	TUESDAY		14
20	WEDNESDAY		15
21	THURSDAY		16
22	FRIDAY		17
23	SATURDAY		18
24	SUNDAY	HOLIDAY	
25	MONDAY		19
26	TUESDAY		20
27	WEDNESDAY		21
28	THURSDAY		22
29	FRIDAY	SARASWATHI POOJA - HOLIDAY	
30	SATURDAY	VIJAYA DASAMI - HOLIDAY	

 PRINCIPAL,
 K. S. R. INSTITUTE FOR
 ENGINEERING AND TECHNOLOGY,
 K. S. R. KALVI NAGAR,
 TIRUCHENGODE-637 215,
 NAMAKKAL Dt, TAMIL NADU.

OCTOBER 2017

Date	Day	Particulars	No. of Working Days
1	SUNDAY	MOHARRAM* - HOLIDAY	
2	MONDAY	GANDHI JAYANTHI - HOLIDAY	
3	TUESDAY		23
4	WEDNESDAY		24
5	THURSDAY		25
6	FRIDAY		26
7	SATURDAY		27
8	SUNDAY	HOLIDAY	
9	MONDAY		28
10	TUESDAY		29
11	WEDNESDAY		30
12	THURSDAY		31
13	FRIDAY		32
14	SATURDAY	Compensation for 16.10.17(Monday order)	33
15	SUNDAY	HOLIDAY	
16	MONDAY	HOLIDAY	
17	TUESDAY	HOLIDAY	
18	WEDNESDAY	DEEPAVALI - HOLIDAY	
19	THURSDAY	HOLIDAY	
20	FRIDAY		34
21	SATURDAY	Compensation for 17.10.17(Tuesday order)	35
22	SUNDAY	HOLIDAY	
23	MONDAY	Internal Assessment- I S1	36
24	TUESDAY	S2	37
25	WEDNESDAY	S3	38
26	THURSDAY	S4	39
27	FRIDAY	S5	40
28	SATURDAY	S6	41
29	SUNDAY	HOLIDAY	
30	MONDAY		42
31	TUESDAY		43

NOVEMBER 2017

Date	Day	Particulars	No. of Working Days
1	WEDNESDAY		44
2	THURSDAY		45
3	FRIDAY		46
4	SATURDAY		47
5	SUNDAY	HOLIDAY	
6	MONDAY		48
7	TUESDAY		49
8	WEDNESDAY		50
9	THURSDAY		51
10	FRIDAY		52
11	SATURDAY	HOLIDAY	
12	SUNDAY	HOLIDAY	
13	MONDAY		53
14	TUESDAY		54
15	WEDNESDAY	Internal Assessment- II S1	55
16	THURSDAY	S2	56
17	FRIDAY	S3	57
18	SATURDAY	HOLIDAY	
19	SUNDAY	HOLIDAY	
20	MONDAY	S4	58
21	TUESDAY	S5	59
22	WEDNESDAY	S6	60
23	THURSDAY		61
24	FRIDAY		62
25	SATURDAY		63
26	SUNDAY	HOLIDAY	
27	MONDAY		64
28	TUESDAY		65
29	WEDNESDAY		66
30	THURSDAY		67

*Subjected to change

PRINCIPAL
K. S. R. INSTITUTE FOR
ENGINEERING AND TECHNOLOGY,
K. S. R. KALVI NAGAR,
TIRUCHENGODE-637 215,
NAMAKKAL DI, TAMIL NADU.

DECEMBER 2017

Date	Day	Particulars	No. of Working Days
1	FRIDAY		68
2	SATURDAY	MILADI NABI* HOLIDAY	
3	SUNDAY	HOLIDAY	
4	MONDAY		69
5	TUESDAY		70
6	WEDNESDAY		71
7	THURSDAY		72
8	FRIDAY		73
9	SATURDAY	SECOND SATURDAY - HOLIDAY	
10	SUNDAY	HOLIDAY	
11	MONDAY		74
12	TUESDAY	Internal Assessment- III SI	75
13	WEDNESDAY	S2	76
14	THURSDAY	S3	77
15	FRIDAY	S4	78
16	SATURDAY	S5	79
17	SUNDAY	HOLIDAY	
18	MONDAY	S6	82
19	TUESDAY		83
20	WEDNESDAY	Last Instruction Day for I BE	84
21	THURSDAY		
22	FRIDAY		
23	SATURDAY	FOURTH SATURDAY - HOLIDAY	
24	SUNDAY	HOLIDAY	
25	MONDAY	CHRISTMAS - HOLIDAY	
26	TUESDAY	Last Instruction Day for I ME University practical Examinations*	
27	WEDNESDAY		
28	THURSDAY		
29	FRIDAY		
30	SATURDAY		
31	SUNDAY		

02.01.2018 – University End Sem Examinations for
I BE& ME

PRINCIPAL,
K. S. R. INSTITUTE FOR
ENGINEERING AND TECHNOLOGY,
K. S. P. KAVI NAGAR,
TIRUCHENGODE-637 215,
NAMAKKAL DC, TAMIL NADU.

K S R INSTITUTE FOR ENGINEERING AND TECHNOLOGY TIRUCHENGODE – 637 215.

ACADEMIC SCHEDULE

Even Semester (2017-18)

DEC 2017 – MAY 2018

PROGRAMME: B.E/B.Tech Degree

SEMESTER: IV and VI

PROGRAMME: M.E/M.Tech Degree

SEMESTER: IV

S.No	Date(s)	Schedule
1.	18.12.2017	Commencement of Theory Classes for 4 th and 6 th semester BE/B.Tech
2.	03.02.2018	Completion of 2.5 Units for BE/B.Tech (34 working days)
3.	05.02.2018 – 12.02.2018	<i>Internal Assessment Test I for 4th and 6th semester BE/B.Tech (1.5 units)</i>
4.	01.03.2018	Completion of next 1 unit (19 working days)
5.	02.03.2018 – 08.03.2018	<i>Internal Assessment Test II for 4th and 6th semester BE/B.Tech (1.5 units)</i>
6.	28.03.2018	Completion of next 1.5 unit (21 working days)
7.	02.04.2018 – 09.04.2018	<i>Internal Assessment Test III for 4th and 6th semester BE/B.Tech (2 units)</i>
8.	10.04.2018	Last Instruction Day for B.E & M.E
9.	12.04.2018	Commencement of University Practical Exams
10.	23.04.2018	Commencement of End Semester Examinations for all BE/B.Tech & ME/M.Tech
11.	02.07.2018	Reopening for next semester*

*Subjected to Change

No. of Workings Days: 81



PRINCIPAL



PRINCIPAL
K. S. R. INSTITUTE FOR
ENGINEERING AND TECHNOLOGY
K. S. R. KA. VI NAGAR,
TIRUCHENGODE 637 215,
NAMAKKAL DL, TAMIL NADU.

ACADEMIC SCHEDULE

DECEMBER 2017

Date	Day	Particulars	No. of Working Days
1	FRIDAY		
2	SATURDAY	MILADI NABI - HOLIDAY	
3	SUNDAY	HOLIDAY	
4	MONDAY		
5	TUESDAY		
6	WEDNESDAY		
7	THURSDAY		
8	FRIDAY		
9	SATURDAY	HOLIDAY	
10	SUNDAY	HOLIDAY	
11	MONDAY		
12	TUESDAY		
13	WEDNESDAY		
14	THURSDAY		
15	FRIDAY		
16	SATURDAY		
17	SUNDAY		
18	MONDAY	Commencement of Theory Classes for 4 th & 6 th Sem B.E/M.E	1
19	TUESDAY		2
20	WEDNESDAY		3
21	THURSDAY		4
22	FRIDAY		5
23	SATURDAY		6
24	SUNDAY	HOLIDAY	
25	MONDAY	HOLIDAY - CHRISTMAS	
26	TUESDAY		7
27	WEDNESDAY		8
28	THURSDAY		9
29	FRIDAY		10
30	SATURDAY	HOLIDAY	
31	SUNDAY	HOLIDAY	

JANUARY 2018

Date	Day	Particulars	No. of Working Days
1	MONDAY	NEW YEAR - HOLIDAY	
2	TUESDAY		11
3	WEDNESDAY		12
4	THURSDAY		13
5	FRIDAY		14
6	SATURDAY		15
7	SUNDAY	HOLIDAY	
8	MONDAY		16
9	TUESDAY		17
10	WEDNESDAY		18
11	THURSDAY		19
12	FRIDAY		20
13	SATURDAY	BOGI - HOLIDAY	
14	SUNDAY	PONGAL - HOLIDAY	
15	MONDAY	THIRUVALLUVAR DAY - HOLIDAY	
16	TUESDAY	UZHAVARTHIRUNAL - HOLIDAY	
17	WEDNESDAY		21
18	THURSDAY		22
19	FRIDAY		23
20	SATURDAY		24
21	SUNDAY	HOLIDAY	
22	MONDAY		25
23	TUESDAY		26
24	WEDNESDAY		27
25	THURSDAY		28
26	FRIDAY	REPUBLIC DAY - HOLIDAY	
27	SATURDAY	HOLIDAY	
28	SUNDAY	HOLIDAY	
29	MONDAY		29
30	TUESDAY		30
31	WEDNESDAY		31

**K. S. R. INSTITUTE FOR
 ENGINEERING AND TECHNOLOGY,
 K. S. R. BALVEEDAR,
 TIRUCHENGODE-617 215,
 NARAKKAL Dt, TAMIL NADU.**

FEBRUARY 2018

Date	Day	Particulars	No. of Working Days
1	THURSDAY		32
2	FRIDAY	<i>Symposium*</i>	33
3	SATURDAY	<i>Symposium*</i>	34
4	SUNDAY	HOLIDAY	
5	MONDAY	<i>Internal Assessment- I S1</i>	35
6	TUESDAY	<i>S2</i>	36
7	WEDNESDAY	<i>S3</i>	37
8	THURSDAY	<i>S4</i>	38
9	FRIDAY	<i>S5</i>	39
10	SATURDAY	HOLIDAY	
11	SUNDAY	HOLIDAY	
12	MONDAY	<i>S6</i>	40
13	TUESDAY		41
14	WEDNESDAY		42
15	THURSDAY		43
16	FRIDAY		44
17	SATURDAY	<i>Annual Day*</i>	45
18	SUNDAY	HOLIDAY	
19	MONDAY		46
20	TUESDAY	<i>Founder's Day HOLIDAY</i>	
21	WEDNESDAY		47
22	THURSDAY		48
23	FRIDAY		49
24	SATURDAY	<i>HOLIDAY*</i>	
25	SUNDAY	HOLIDAY	
26	MONDAY		50
27	TUESDAY		51
28	WEDNESDAY		52

MARCH 2018

Date	Day	Particulars	No. of Working Days
1	THURSDAY		53
2	FRIDAY	<i>Internal Assessment- II S1</i>	54
3	SATURDAY	<i>S2</i>	55
4	SUNDAY	HOLIDAY	
5	MONDAY	<i>S3</i>	56
6	TUESDAY	<i>S4</i>	57
7	WEDNESDAY	<i>S5</i>	58
8	THURSDAY	<i>S6</i>	59
9	FRIDAY		60
10	SATURDAY	HOLIDAY	
11	SUNDAY	HOLIDAY	
12	MONDAY		61
13	TUESDAY		62
14	WEDNESDAY		63
15	THURSDAY		64
16	FRIDAY		65
17	SATURDAY	<i>Conference*</i>	66
18	SUNDAY	<i>TELUGU NEW YEAR - HOLIDAY</i>	
19	MONDAY		67
20	TUESDAY		68
21	WEDNESDAY		69
22	THURSDAY		70
23	FRIDAY		71
24	SATURDAY	HOLIDAY	
25	SUNDAY	HOLIDAY	
26	MONDAY		72
27	TUESDAY		73
28	WEDNESDAY		74
29	THURSDAY	<i>MAHAVEER JAYANTHI - HOLIDAY</i>	
30	FRIDAY	<i>GOOD FRIDAY - HOLIDAY</i>	
31	SATURDAY	HOLIDAY	

PRINCIPAL,
 K. S. R. INSTITUTE FOR
 ENGINEERING AND TECHNOLOGY,
 K. S. R. KALVINAGAR,
 TIRUCHENGODE-637 215,
 NAMAKKAL Dt, TAMIL NADU.

APRIL 2018

Date	Day	Particulars	No. of Working Days
1	SUNDAY	HOLIDAY	
2	MONDAY	Internal Assessment-III S1	75
3	TUESDAY	S2	76
4	WEDNESDAY	S3	77
5	THURSDAY	S4	78
6	FRIDAY	S5	79
7	SATURDAY	HOLIDAY	
8	SUNDAY	HOLIDAY	
9	MONDAY	S6	80
10	TUESDAY	Last Instruction Day	81
11	WEDNESDAY		
12	THURSDAY	University Practical Examinations	
13	FRIDAY		
14	SATURDAY	TAMIL NEW YEAR-Dr.AMBEDKAR BIRTHDAY - HOLIDAY	
15	SUNDAY	HOLIDAY	
16	MONDAY		
17	TUESDAY		
18	WEDNESDAY		
19	THURSDAY		
20	FRIDAY		
21	SATURDAY	HOLIDAY	
22	SUNDAY	HOLIDAY	
23	MONDAY	University End Sem Examinations	
24	TUESDAY		
25	WEDNESDAY		
26	THURSDAY		
27	FRIDAY		
28	SATURDAY	HOLIDAY	
29	SUNDAY	HOLIDAY	
30	MONDAY		

MAY 2018

Date	Day	Particulars	No. of Working Days
1	TUESDAY	MAY DAY - HOLIDAY	
2	WEDNESDAY		
3	THURSDAY		
4	FRIDAY		
5	SATURDAY	HOLIDAY	
6	SUNDAY	HOLIDAY	
7	MONDAY		
8	TUESDAY		
9	WEDNESDAY		
10	THURSDAY		
11	FRIDAY		
12	SATURDAY	HOLIDAY	
13	SUNDAY	HOLIDAY	
14	MONDAY		
15	TUESDAY		
16	WEDNESDAY		
17	THURSDAY		
18	FRIDAY		
19	SATURDAY	HOLIDAY	
20	SUNDAY	HOLIDAY	
21	MONDAY		
22	TUESDAY		
23	WEDNESDAY		
24	THURSDAY		
25	FRIDAY		
26	SATURDAY	HOLIDAY	
27	SUNDAY	HOLIDAY	
28	MONDAY		
29	TUESDAY		
30	WEDNESDAY		
31	THURSDAY		

 K. S. H. INSTITUTE FOR
 ENGINEERING AND TECHNOLOGY,
 K. S. H. CAMPUS,
 TIRUCHENAI-600 075,
 TAMIL NADU.

K S R INSTITUTE FOR ENGINEERING AND TECHNOLOGY TIRUCHENGODE – 637 215.

ACADEMIC SCHEDULE

Even Semester (2017-18)

DEC 2017 – MAY 2018

PROGRAMME: B.E/B.Tech Degree

SEMESTER: VIII

S.No	Date(s)	Schedule
1.	18.12.2017	Commencement of Theory Classes for 8 th semester BE/B.Tech
2.	02.01.2018	Completion of 2.5 Units for BE/B.Tech (11 working days)
3.	03.01.2018 – 06.01.2018	Internal Assessment Test I for 8 th semester BE/B.Tech (1.5 units)
4.	12.01.2018	Completion of next 1 unit (9 working days)
5.	17.01.2018 – 20.01.2018	Internal Assessment Test II for 8 th semester BE/B.Tech (1.5 units)
6.	03.02.2018	Completion of next 1.5 unit (14 working days)
7.	05.02.2018 – 08.02.2018	Internal Assessment Test III for 8 th semester BE/B.Tech (2 units)
8.	10.04.2018	Last Instruction Day for B.E
9.	12.04.2018	Commencement of University Practical Exams
10.	23.04.2018	Commencement of End Semester Examinations for all BE/B.Tech
11.	02.07.2018	Reopening for next semester*

*Subjected to Change

No. of Workings Days: 81 working days



28/12/17
PRINCIPAL



PRINCIPAL,
K. S. R. INSTITUTE FOR
ENGINEERING AND TECHNOLOGY,
K. S. R. KALVI NAGAR,
TIRUCHENGODE-637 215,
NAMAKKAL Dt. TAMIL NADU.

ACADEMIC SCHEDULE

DECEMBER 2017

Date	Day	Particulars	No. of Working Days
1	FRIDAY		
2	SATURDAY	MILADI NABI - HOLIDAY	
3	SUNDAY	HOLIDAY	
4	MONDAY		
5	TUESDAY		
6	WEDNESDAY		
7	THURSDAY		
8	FRIDAY		
9	SATURDAY	HOLIDAY	
10	SUNDAY	HOLIDAY	
11	MONDAY		
12	TUESDAY		
13	WEDNESDAY		
14	THURSDAY		
15	FRIDAY		
16	SATURDAY		
17	SUNDAY		
18	MONDAY	Commencement of Theory Classes for 8 th Sem B.E	1
19	TUESDAY		2
20	WEDNESDAY		3
21	THURSDAY		4
22	FRIDAY		5
23	SATURDAY	REVIEW 0	6
24	SUNDAY	HOLIDAY	
25	MONDAY	HOLIDAY - CHRISTMAS	
26	TUESDAY		7
27	WEDNESDAY		8
28	THURSDAY		9
29	FRIDAY		10
30	SATURDAY	HOLIDAY	
31	SUNDAY	HOLIDAY	

JANUARY 2018

Date	Day	Particulars	No. of Working Days
1	MONDAY	NEW YEAR - HOLIDAY	
2	TUESDAY		11
3	WEDNESDAY	Internal Assessment- 1 S1	12
4	THURSDAY	S2	13
5	FRIDAY	S3	14
6	SATURDAY	S4	15
7	SUNDAY	HOLIDAY	
8	MONDAY		16
9	TUESDAY		17
10	WEDNESDAY		18
11	THURSDAY		19
12	FRIDAY		20
13	SATURDAY	BOGI - HOLIDAY	
14	SUNDAY	PONGAL - HOLIDAY	
15	MONDAY	THIRUVALUVAR DAY- HOLIDAY	
16	TUESDAY	UZHAVARTHIRUNAL - HOLIDAY	
17	WEDNESDAY	Internal Assessment- 1 S1	21
18	THURSDAY	S2	22
19	FRIDAY	S3	23
20	SATURDAY	S4	24
21	SUNDAY	HOLIDAY	
22	MONDAY	REVIEW 1	25
23	TUESDAY		26
24	WEDNESDAY		27
25	THURSDAY		28
26	FRIDAY	REPUBLIC DAY - HOLIDAY	
27	SATURDAY	HOLIDAY	
28	SUNDAY	HOLIDAY	
29	MONDAY		29
30	TUESDAY		30
31	WEDNESDAY		31

 PRINCIPAL
 K. S. R. INSTITUTE FOR
 ENGINEERING AND TECHNOLOGY,
 K. S. R. RAJANAGAR,
 TIRUCHENGODE-637 215,
 NAMAKKAL DISTRICT, TAMIL NADU.

FEBRUARY 2018

Date	Day	Particulars	No. of Working Days
1	THURSDAY		32
2	FRIDAY	<i>Symposium*</i>	33
3	SATURDAY	<i>Symposium*</i>	34
4	SUNDAY	HOLIDAY	
5	MONDAY	<i>Internal Assessment- III SI</i>	35
6	TUESDAY	<i>S2</i>	36
7	WEDNESDAY	<i>S3</i>	37
8	THURSDAY	<i>S4</i>	38
9	FRIDAY		39
10	SATURDAY	HOLIDAY	
11	SUNDAY	HOLIDAY	
12	MONDAY	<i>Review 2 & submission of 1 & 2 chapters</i>	40
13	TUESDAY		41
14	WEDNESDAY		42
15	THURSDAY		43
16	FRIDAY		44
17	SATURDAY	<i>Annual Day*</i>	45
18	SUNDAY	HOLIDAY	
19	MONDAY		46
20	TUESDAY	<i>Founder's Day HOLIDAY</i>	
21	WEDNESDAY		47
22	THURSDAY		48
23	FRIDAY		49
24	SATURDAY	<i>HOLIDAY*</i>	
25	SUNDAY	HOLIDAY	
26	MONDAY		50
27	TUESDAY		51
28	WEDNESDAY		52

MARCH 2018

Date	Day	Particulars	No. of Working Days
1	THURSDAY		53
2	FRIDAY		54
3	SATURDAY		55
4	SUNDAY	HOLIDAY	
5	MONDAY		56
6	TUESDAY		57
7	WEDNESDAY	<i>Submission of 3 & 4 chapters</i>	58
8	THURSDAY		59
9	FRIDAY		60
10	SATURDAY	HOLIDAY	
11	SUNDAY	HOLIDAY	
12	MONDAY		61
13	TUESDAY		62
14	WEDNESDAY		63
15	THURSDAY		64
16	FRIDAY		65
17	SATURDAY	<i>Conference*</i>	66
18	SUNDAY	<i>TELUGU NEW YEAR - HOLIDAY</i>	
19	MONDAY		67
20	TUESDAY	<i>Project 100% Completed Demo & Project Report Submission rough copy</i>	68
21	WEDNESDAY		69
22	THURSDAY		70
23	FRIDAY		71
24	SATURDAY	HOLIDAY	
25	SUNDAY	HOLIDAY	
26	MONDAY		72
27	TUESDAY		73
28	WEDNESDAY		74
29	THURSDAY	<i>MAHAVEER JAYANTHI - HOLIDAY</i>	
30	FRIDAY	<i>GOOD FRIDAY - HOLIDAY</i>	
31	SATURDAY	HOLIDAY	

PRINCIPAL,
K. S. R. INSTITUTE FOR
ENGINEERING AND TECHNOLOGY,
K. S. R. KALVI NAGAR,
TIRUCHENGODE-637 215,
NAMAKKAL DL TAMIL NADU.

APRIL 2018

Date	Day	Particulars	No. of Working Days
1	SUNDAY	HOLIDAY	
2	MONDAY		75
3	TUESDAY	<i>PROJECT REPORT</i>	76
4	WEDNESDAY	<i>BONAFICATION &</i>	77
5	THURSDAY	<i>MODEL VIVA VOCE</i>	78
6	FRIDAY		79
7	SATURDAY	HOLIDAY	
8	SUNDAY	HOLIDAY	
9	MONDAY		80
10	TUESDAY	<i>Last Instruction Day</i>	81
11	WEDNESDAY		
12	THURSDAY	<i>University Practical Examinations</i>	
13	FRIDAY		
14	SATURDAY	<i>TAMIL NEW YEAR- Dr.AMBEDKAR BIRTHDAY - HOLIDAY</i>	
15	SUNDAY	HOLIDAY	
16	MONDAY		
17	TUESDAY		
18	WEDNESDAY		
19	THURSDAY		
20	FRIDAY		
21	SATURDAY	HOLIDAY	
22	SUNDAY	HOLIDAY	
23	MONDAY	<i>University End Sem Examinations</i>	
24	TUESDAY		
25	WEDNESDAY		
26	THURSDAY		
27	FRIDAY		
28	SATURDAY	HOLIDAY	
29	SUNDAY	HOLIDAY	
30	MONDAY		

MAY 2018

Date	Day	Particulars	No. of Working Days
1	TUESDAY	<i>MAY DAY - HOLIDAY</i>	
2	WEDNESDAY		
3	THURSDAY		
4	FRIDAY		
5	SATURDAY	HOLIDAY	
6	SUNDAY	HOLIDAY	
7	MONDAY		
8	TUESDAY		
9	WEDNESDAY		
10	THURSDAY		
11	FRIDAY		
12	SATURDAY	HOLIDAY	
13	SUNDAY	HOLIDAY	
14	MONDAY		
15	TUESDAY		
16	WEDNESDAY		
17	THURSDAY		
18	FRIDAY		
19	SATURDAY	HOLIDAY	
20	SUNDAY	HOLIDAY	
21	MONDAY		
22	TUESDAY		
23	WEDNESDAY		
24	THURSDAY		
25	FRIDAY		
26	SATURDAY	HOLIDAY	
27	SUNDAY	HOLIDAY	
28	MONDAY		
29	TUESDAY		
30	WEDNESDAY		
31	THURSDAY		

 PRINCIPAL,
 K. S. R. INSTITUTE FOR
 ENGINEERING AND TECHNOLOGY,
 K. S. R. INSTITUTE FOR
 TIRUCHENAI - 637 215,
 NAMAKKAL DI, TAMIL NADU.

K S R INSTITUTE FOR ENGINEERING AND TECHNOLOGY TIRUCHENGODE – 637 215.

ACADEMIC SCHEDULE

Even Semester (2017-18)

DEC 2017 – MAY 2018

PROGRAMME: B.E/B.Tech Degree

SEMESTER: II

PROGRAMME: M.E/M.Tech Degree

SEMESTER: II

S. No	Date(s)	Schedule
1.	22.01.2018	Commencement of Theory Classes for 2 nd semester BE/B.Tech & ME/M.Tech
2.	05.03.2018	Completion of 2.5 Units for BE/B.Tech (32 working days)
3.	06.03.2018 – 13.03.2018	Internal Assessment Test I for 2 nd sem UG & PG (1.5 units)
4.	03.04.2018	Completion of next 1.5 units (20 working days)
5.	04.04.2018 – 11.04.2018	Internal Assessment Test II for 2 nd sem UG & PG (1.5 units)
6.	24.04.2018	Completion of last one unit (16 working days)
7.	25.04.2018 – 03.05.2018	Internal Assessment Test III for 2 nd sem UG & PG (2 units)
8.	05.05.2018	Last Instruction Day for B.E & M.E
9.	07.05.2018	Commencement of University Practical Exams
10.	17.05.2018	Commencement of End Semester Examinations for I yr/ II sem UG & PG
11.	02.07.2018	Reopening for next semester

*Subjected to Change

No. of Workings Days: 78



PRINCIPAL



PRINCIPAL,
K. S. R. INSTITUTE FOR
ENGINEERING AND TECHNOLOGY,
K. S. R. KALVI NAGAR,
TIRUCHENGODE-637 215,
NAMAKKAL DL, TAMIL NADU.

ACADEMIC SCHEDULE

DECEMBER 2017

Date	Day	Particulars	No. of Working Days
1	FRIDAY		
2	SATURDAY	MILADI NABI - HOLIDAY	
3	SUNDAY	HOLIDAY	
4	MONDAY		
5	TUESDAY		
6	WEDNESDAY		
7	THURSDAY		
8	FRIDAY		
9	SATURDAY	HOLIDAY	
10	SUNDAY	HOLIDAY	
11	MONDAY		
12	TUESDAY		
13	WEDNESDAY		
14	THURSDAY		
15	FRIDAY		
16	SATURDAY		
17	SUNDAY		
18	MONDAY		
19	TUESDAY		
20	WEDNESDAY		
21	THURSDAY		
22	FRIDAY		
23	SATURDAY		
24	SUNDAY	HOLIDAY	
25	MONDAY	HOLIDAY - CHRISTMAS	
26	TUESDAY		
27	WEDNESDAY		
28	THURSDAY		
29	FRIDAY		
30	SATURDAY	HOLIDAY	
31	SUNDAY	HOLIDAY	

JANUARY 2018

Date	Day	Particulars	No. of Working Days
1	MONDAY	NEW YEAR - HOLIDAY	
2	TUESDAY		
3	WEDNESDAY		
4	THURSDAY		
5	FRIDAY		
6	SATURDAY		
7	SUNDAY	HOLIDAY	
8	MONDAY		
9	TUESDAY		
10	WEDNESDAY		
11	THURSDAY		
12	FRIDAY		
13	SATURDAY	BOGI - HOLIDAY	
14	SUNDAY	PONGAL - HOLIDAY	
15	MONDAY	THIRUVALLUVAR DAY - HOLIDAY	
16	TUESDAY	UZHAVARTHIRUNAL - HOLIDAY	
17	WEDNESDAY		
18	THURSDAY		
19	FRIDAY		
20	SATURDAY		
21	SUNDAY	HOLIDAY	
22	MONDAY	Commencement of Theory Classes for 2 nd Sem B.E/M.E	1
23	TUESDAY		2
24	WEDNESDAY		3
25	THURSDAY		4
26	FRIDAY	REPUBLIC DAY - HOLIDAY	
27	SATURDAY	HOLIDAY	
28	SUNDAY	HOLIDAY	
29	MONDAY		5
30	TUESDAY		6
31	WEDNESDAY		7



 PRINCIPAL
 K. S. R. INSTITUTE FOR
 ENGINEERING AND TECHNOLOGY,
 K. S. R. KALVINAGAR,
 TIRUCHENGODE-637 215,
 NAMAKKAL DL, TAMIL NADU.

FEBRUARY 2018

Date	Day	Particulars	No. of Working Days
1	THURSDAY		8
2	FRIDAY	<i>Symposium*</i>	9
3	SATURDAY	<i>Symposium*</i>	10
4	SUNDAY	HOLIDAY	
5	MONDAY		11
6	TUESDAY		12
7	WEDNESDAY		13
8	THURSDAY		14
9	FRIDAY		15
10	SATURDAY	HOLIDAY	
11	SUNDAY	HOLIDAY	
12	MONDAY		16
13	TUESDAY		17
14	WEDNESDAY		18
15	THURSDAY		19
16	FRIDAY		20
17	SATURDAY	<i>Annual Day*</i>	21
18	SUNDAY	HOLIDAY	
19	MONDAY		22
20	TUESDAY	<i>Founder's Day</i> HOLIDAY	
21	WEDNESDAY		23
22	THURSDAY		24
23	FRIDAY		25
24	SATURDAY	<i>HOLIDAY*</i>	
25	SUNDAY	HOLIDAY	
26	MONDAY		26
27	TUESDAY		27
28	WEDNESDAY		28

MARCH 2018

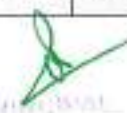
Date	Day	Particulars	No. of Working Days
1	THURSDAY		29
2	FRIDAY		30
3	SATURDAY		31
4	SUNDAY	HOLIDAY	
5	MONDAY		32
6	TUESDAY	<i>Internal Assessment- I</i> <i>S1</i>	33
7	WEDNESDAY	<i>S2</i>	34
8	THURSDAY	<i>S3</i>	35
9	FRIDAY	<i>S4</i>	36
10	SATURDAY	HOLIDAY	
11	SUNDAY	HOLIDAY	
12	MONDAY	<i>S5</i>	37
13	TUESDAY	<i>S6</i>	38
14	WEDNESDAY		39
15	THURSDAY		40
16	FRIDAY		41
17	SATURDAY	<i>Conference*</i>	42
18	SUNDAY	<i>TELUGU NEW YEAR</i> <i>- HOLIDAY</i>	
19	MONDAY		43
20	TUESDAY		44
21	WEDNESDAY		45
22	THURSDAY		46
23	FRIDAY		47
24	SATURDAY	HOLIDAY	
25	SUNDAY	HOLIDAY	
26	MONDAY		48
27	TUESDAY		49
28	WEDNESDAY		50
29	THURSDAY	<i>MAHAVEER</i> <i>JAYANTHI -</i> <i>HOLIDAY</i>	
30	FRIDAY	<i>GOOD FRIDAY -</i> <i>HOLIDAY</i>	
31	SATURDAY	HOLIDAY	

 PRINCIPAL
 K. S. M. INSTITUTE FOR
 ENGINEERING & TECHNOLOGY
 K. S. M. INSTITUTE FOR
 TIRUCHENGODE-637 215,
 NAMAKKAL Dt. TAMIL NADU.

APRIL 2018

Date	Day	Particulars	No. of Working Days
1	SUNDAY	HOLIDAY	
2	MONDAY		51
3	TUESDAY		52
4	WEDNESDAY	Internal Assessment- II S1	53
5	THURSDAY	S2	54
6	FRIDAY	S3	55
7	SATURDAY	HOLIDAY	
8	SUNDAY	HOLIDAY	
9	MONDAY	S4	56
10	TUESDAY	S5	57
11	WEDNESDAY	S6	58
12	THURSDAY		59
13	FRIDAY		60
14	SATURDAY	TAMIL NEW YEAR- Dr.AMBEDKAR BIRTHDAY - HOLIDAY	
15	SUNDAY	HOLIDAY	
16	MONDAY		61
17	TUESDAY		62
18	WEDNESDAY		63
19	THURSDAY		64
20	FRIDAY		65
21	SATURDAY		66
22	SUNDAY		
23	MONDAY		67
24	TUESDAY		68
25	WEDNESDAY	Internal Assessment- III S1	69
26	THURSDAY	S2	70
27	FRIDAY	S3	71
28	SATURDAY	HOLIDAY	
29	SUNDAY	HOLIDAY	
30	MONDAY	S4	72

MAY 2018

Date	Day	Particulars	No. of Working Days
1	TUESDAY	MAY DAY - HOLIDAY	
2	WEDNESDAY	S5	75
3	THURSDAY	S6	76
4	FRIDAY		77
5	SATURDAY	Last Instruction Day	78
6	SUNDAY	HOLIDAY	
7	MONDAY	University Practical Examinations	
8	TUESDAY		
9	WEDNESDAY		
10	THURSDAY		
11	FRIDAY		
12	SATURDAY	HOLIDAY	
13	SUNDAY	HOLIDAY	
14	MONDAY		
15	TUESDAY		
16	WEDNESDAY		
17	THURSDAY	End Semester Examinations	
18	FRIDAY		
19	SATURDAY	HOLIDAY	
20	SUNDAY	HOLIDAY	
21	MONDAY		
22	TUESDAY		
23	WEDNESDAY		
24	THURSDAY		
25	FRIDAY		
26	SATURDAY	HOLIDAY	
27	SUNDAY	HOLIDAY	
28	MONDAY		
29	TUESDAY		
30	WEDNESDAY		
31	THURSDAY		

 PRINCIPAL,
 K. S. R. INSTITUTE FOR
 ENGINEERING AND TECHNOLOGY,
 K. S. R. ROAD, TIRUCHENGODE,
 TIRUCHENGODE-637 215,
 NAMAKKAL Dt, TAMIL NADU.

K S R INSTITUTE FOR ENGINEERING AND TECHNOLOGY TIRUCHENGODE – 637 215.

ACADEMIC SCHEDULE REVISED**ODD Semester (2018-19)****JUL 2018– OCT 2018****PROGRAMME: B.E/B.Tech Degree****SEMESTER: III, V & VII****PROGRAMME: M.E/M.Tech Degree****SEMESTER: III**

S.No	Date(s)	Schedule
1.	02.07.2018	Commencement of Classes for 3 rd , 5 th and 7 th semester BE/B.Tech & M.E/M.Tech
2.	15.08.2018	Completion of 2.5 Units for BE/B.Tech (35 working days)
3.	17.08.2018 – 24.08.2018	<i>Internal Assessment Test I for 3rd, 5th and 7th semester BE/B.Tech & M.E/M.Tech (1.5 units)</i>
4.	12.09.2018	Completion of next 1.5 units (20 working days)
5.	14.09.2018 – 20.09.2018	<i>Internal Assessment Test II for 3rd, 5th and 7th semester BE/B.Tech & M.E/M.Tech (1.5 units)</i>
6.	09.10.2018	Completion of next 1 unit (18 working days)
7.	10.10.2018 – 16.10.2018	<i>Internal Assessment Test III for 3rd, 5th and 7th semester BE/B.Tech & M.E/M.Tech (2 units)</i>
8.	17.10.2018	Last Instruction day
9.	22.10.2018	Commencement of University Practical Exams
10.	01.11.2018	Commencement of End Semester Examinations for all BE/B.Tech & M.E/M.Tech
11.	17.12.2018	Reopening for next semester

No. of Workings Days: 80

PRINCIPAL



PRINCIPAL,
K S R INSTITUTE FOR
ENGINEERING AND TECHNOLOGY,
K. S. R. KALVI NAGAR,
TIRUCHENGODE-637 215,
NAMAKKAL Dt, TAMIL NADU.

ACADEMIC SCHEDULE

JULY 2018

Date	Day	Particulars	No. of Working Days
1	SUNDAY	HOLIDAY	
2	MONDAY	Commencement of Theory Classes for 3 rd 5 th & 7 th Sem B.E & M.E	1
3	TUESDAY		2
4	WEDNESDAY		3
5	THURSDAY		4
6	FRIDAY		5
7	SATURDAY		6
	SUNDAY	HOLIDAY	
9	MONDAY		7
10	TUESDAY		8
11	WEDNESDAY		9
12	THURSDAY		10
13	FRIDAY		11
14	SATURDAY	SECOND SATURDAY-HOLIDAY	
15	SUNDAY	HOLIDAY	
16	MONDAY		12
17	TUESDAY		13
18	WEDNESDAY		14
19	THURSDAY		15
20	FRIDAY		16
21	SATURDAY		17
22	SUNDAY	HOLIDAY	
23	MONDAY		18
	TUESDAY		19
25	WEDNESDAY		20
26	THURSDAY		21
27	FRIDAY		22
28	SATURDAY	Compensation or 04.08.2018	23
29	SUNDAY	HOLIDAY	
30	MONDAY		24
31	TUESDAY		25

AUGUST 2018

Date	Day	Particulars	No. of Working Days
1	WEDNESDAY		26
2	THURSDAY		27
3	FRIDAY	ADI PERUKU-HOLIDAY	
4	SATURDAY	HOLIDAY	
5	SUNDAY	HOLIDAY	
6	MONDAY		28
7	TUESDAY		29
8	WEDNESDAY		30
9	THURSDAY		31
10	FRIDAY		32
11	SATURDAY	SECOND SATURDAY-HOLIDAY	
12	SUNDAY	HOLIDAY	
13	MONDAY		33
14	TUESDAY		34
15	WEDNESDAY	Independence day - holiday	
16	THURSDAY		35
17	FRIDAY	Internal Assessment- I S1	36
18	SATURDAY	S2	37
19	SUNDAY	HOLIDAY	
20	MONDAY	S3	38
21	TUESDAY	S4	39
22	WEDNESDAY	BAKRID - HOLIDAY	
23	THURSDAY	S5	40
24	FRIDAY	S6	41
25	SATURDAY	FOURTH SATURDAY - HOLIDAY	
26	SUNDAY	HOLIDAY	
27	MONDAY		42
28	TUESDAY		43
29	WEDNESDAY		44
30	THURSDAY		45
31	FRIDAY		46

 PRINCIPAL,
 K. S. R. INSTITUTE FOR
 ENGINEERING AND TECHNOLOGY,
 K. S. R. KALANGUDAR,
 TIRUCHENGODE-677 215,
 NAMAKKAL Dt, TAMIL NADU.

SEPTEMBER 2018

OCTOBER 2018

Date	Day	Particulars	No. of Working Days
1	SATURDAY		47
2	SUNDAY	<i>Krishna Jayanthi - HOLIDAY</i>	
3	MONDAY		48
4	TUESDAY		49
5	WEDNESDAY		50
6	THURSDAY		51
7	FRIDAY		52
8	SATURDAY	HOLIDAY	
9	SUNDAY	HOLIDAY	
10	MONDAY		53
11	TUESDAY		54
12	WEDNESDAY		55
13	THURSDAY	<i>Vinayakar Chathurthi HOLIDAY</i>	
14	FRIDAY	<i>Internal Assessment- II S1</i>	56
15	SATURDAY	<i>S2</i>	57
16	SUNDAY	HOLIDAY	
17	MONDAY	<i>S3</i>	58
18	TUESDAY	<i>S4</i>	59
19	WEDNESDAY	<i>S5</i>	60
20	THURSDAY	<i>S6</i>	61
21	FRIDAY	<i>MOHARRAM* - HOLIDAY</i>	
22	SATURDAY	HOLIDAY	
23	SUNDAY	HOLIDAY	
24	MONDAY		62
25	TUESDAY		63
26	WEDNESDAY		64
27	THURSDAY		65
28	FRIDAY		66
29	SATURDAY		67
30	SUNDAY	HOLIDAY	

Date	Day	Particulars	No. of Working Days
1	MONDAY	HOLIDAY	
2	TUESDAY	<i>GANDHI JAYANTHI - HOLIDAY</i>	
3	WEDNESDAY		68
4	THURSDAY		69
5	FRIDAY		70
6	SATURDAY		71
7	SUNDAY	HOLIDAY	
8	MONDAY		72
9	TUESDAY		73
10	WEDNESDAY	<i>Internal Assessment- III S1</i>	74
11	THURSDAY	<i>S2</i>	75
12	FRIDAY	<i>S3</i>	76
13	SATURDAY	<i>S4 Compensation for 01.10.2018</i>	77
14	SUNDAY	HOLIDAY	
15	MONDAY	<i>S5</i>	78
16	TUESDAY	<i>S6</i>	79
17	WEDNESDAY	<i>Last Instruction Day</i>	80
18	THURSDAY	<i>SARASWATHI POOJA - HOLIDAY</i>	
19	FRIDAY	<i>VIJAYA DASAMI - HOLIDAY</i>	
20	SATURDAY	HOLIDAY	
21	SUNDAY	HOLIDAY	
22	MONDAY	<i>University practical Examinations</i>	
23	TUESDAY		
24	WEDNESDAY		
25	THURSDAY		
26	FRIDAY		
27	SATURDAY	FOURTH SATURDAY - HOLIDAY	
28	SUNDAY	HOLIDAY	
29	MONDAY		
30	TUESDAY		
31	WEDNESDAY		

01.11.2018 – Commencement of End Semester Examinations

 PRINCIPAL,
 K. S. R. INSTITUTE FOR
 ENGINEERING AND TECHNOLOGY,
 K. S. R. VI NAGAR,
 TIRUCHENGODE-637 215,
 NAMAKKAL Dt, TAMIL NADU.

ACADEMIC SCHEDULE REVISED

ODD Semester (2018-19)

AUG 2018– DEC 2018

PROGRAMME: B.E/B.Tech Degree

SEMESTER: I

PROGRAMME: M.E/M.Tech Degree

SEMESTER: I

S.No	Date(s)	Schedule
1.	27.08.2018	Commencement of Classes for 1 st semester BE/B.Tech
2.	03.09.2018	Commencement of Classes for 1 st semester ME/M.Tech
3.	29.09.2018	Completion of 2.5 Units for BE/B.Tech (32 working days)
4.	10.10.2018 – 16.10.2018	<i>Internal Assessment Test I for 1st semester BE/B.Tech & M.E/M.Tech (1.5 units)</i>
5.	30.10.2018	Completion of next 1 unit (16 working day)
6.	01.11.2018 – 10.11.2018	<i>Internal Assessment Test II for 1st semester BE/B.Tech & M.E/M.Tech (1.5 units)</i>
7.	01.12.2018	Completion of 1.5 units (23 working days)
8.	03.12.2018 – 08.12.2018	<i>Internal Assessment Test III for 3rd, 5th and 7th semester BE/B.Tech & M.E/M.Tech (2 units)</i>
9.	10.12.2018	Last Instruction day for BE
10.	15.12.2018	Last Instruction day for ME
11.	12.12.2018	Commencement of University Practical Exams for BE
12.	17.12.2018	Commencement of University Practical Exams for ME
13.	29.12.2018	Commencement of End Semester Examinations for all BE/B.Tech& M.E/M.Tech *
14.	30.01.2018	Reopening for next semester*

No. of Workings Days: 78

PRINCIPAL,
 K. S. R. INSTITUTE FOR
 ENGINEERING AND TECHNOLOGY,
 K. S. R. KALVI NAGAR,
 TIRUCHENGODE-637 215,
 NAMAKKAL DI, TAMIL NADU.

 24/07/18
PRINCIPAL

ACADEMIC SCHEDULE

AUGUST 2018

SEPTEMBER 2018

Date	Day	Particulars	No. of Working Days
1	WEDNESDAY		
2	THURSDAY		
3	FRIDAY	<i>ADI PERUKU- HOLIDAY</i>	
4	SATURDAY	HOLIDAY	
5	SUNDAY	HOLIDAY	
6	MONDAY		
7	TUESDAY		
	WEDNESDAY		
9	THURSDAY		
10	FRIDAY		
11	SATURDAY	SECOND SATURDAY- HOLIDAY	
12	SUNDAY	HOLIDAY	
13	MONDAY		
14	TUESDAY		
15	WEDNESDAY	<i>Independence day - holiday</i>	
16	THURSDAY		
17	FRIDAY		
18	SATURDAY		
19	SUNDAY	HOLIDAY	
20	MONDAY		
21	TUESDAY		
	WEDNESDAY	<i>BAKRID - HOLIDAY</i>	
23	THURSDAY		
24	FRIDAY		
25	SATURDAY	FOURTH SATURDAY - HOLIDAY	
26	SUNDAY	HOLIDAY	
27	MONDAY	<i>Commencement of Classes for 1st semester BE/B.Tech</i>	1
28	TUESDAY		2
29	WEDNESDAY		3
30	THURSDAY		4
31	FRIDAY		5

Date	Day	Particulars	No. of Working Days
1	SATURDAY		6
2	SUNDAY	<i>Krishna Jayanthi - HOLIDAY</i>	
3	MONDAY	<i>Commencement of Theory Classes for 1st Sem M.E</i>	7
4	TUESDAY		8
5	WEDNESDAY		9
6	THURSDAY		10
7	FRIDAY		11
8	SATURDAY	HOLIDAY	
9	SUNDAY	HOLIDAY	
10	MONDAY		12
11	TUESDAY		13
12	WEDNESDAY		14
13	THURSDAY	<i>Vinayakar Chaturthi HOLIDAY</i>	
14	FRIDAY		15
15	SATURDAY		16
16	SUNDAY	HOLIDAY	
17	MONDAY		17
18	TUESDAY		18
19	WEDNESDAY		19
20	THURSDAY		20
21	FRIDAY	<i>MOHARRAM* - HOLIDAY</i>	
22	SATURDAY	HOLIDAY	
23	SUNDAY	HOLIDAY	
24	MONDAY		21
25	TUESDAY		22
26	WEDNESDAY		23
27	THURSDAY		24
28	FRIDAY		25
29	SATURDAY		26
30	SUNDAY	HOLIDAY	

PRINCIPAL,
 K. S. R. INSTITUTE FOR
 ENGINEERING AND TECHNOLOGY,
 K. S. R. KALVI NAGAR,
 TIRUCHENGODE-637 215,
 NAMAKKAL DI, TAMIL NADU.

NOVEMBER 2018

OCTOBER 2018

Date	Day	Particulars	No. of Working Days
1	MONDAY	HOLIDAY	
2	TUESDAY	GANDHI JAYANTHI - HOLIDAY	
3	WEDNESDAY		27
4	THURSDAY		28
5	FRIDAY		29
6	SATURDAY		30
7	SUNDAY	HOLIDAY	
8	MONDAY		31
9	TUESDAY		32
10	WEDNESDAY	Internal Assessment- I S1	33
11	THURSDAY	S2	34
12	FRIDAY	S3	35
13	SATURDAY	S4 Compensation for 01.10.2018	36
14	SUNDAY	HOLIDAY	
15	MONDAY	S5	37
16	TUESDAY	S6	38
17	WEDNESDAY		39
18	THURSDAY	SARASWATHI POOJA - HOLIDAY	
19	FRIDAY	VIJAYA DASAMI - HOLIDAY	
20	SATURDAY	HOLIDAY	
21	SUNDAY	HOLIDAY	
22	MONDAY		40
23	TUESDAY		41
24	WEDNESDAY		42
25	THURSDAY		43
26	FRIDAY		44
27	SATURDAY	Compensation for 20.10.2018	45
28	SUNDAY	HOLIDAY	
29	MONDAY		46
30	TUESDAY		47
31	WEDNESDAY		48

Date	Day	Particulars	No. of Working Days
1	THURSDAY	Internal Assessment- II S1	49
2	FRIDAY	S2	50
3	SATURDAY	S3	51
4	SUNDAY	HOLIDAY	
5	MONDAY	HOLIDAY	
6	TUESDAY	Deepavali HOLIDAY	
7	WEDNESDAY	HOLIDAY	
8	THURSDAY	S4	52
9	FRIDAY	S5	53
10	SATURDAY	S6 Compensation for 05.11.2018	54
11	SUNDAY	HOLIDAY	
12	MONDAY		55
13	TUESDAY		56
14	WEDNESDAY		57
15	THURSDAY		58
16	FRIDAY		59
17	SATURDAY		60
18	SUNDAY	HOLIDAY	
19	MONDAY		61
20	TUESDAY		62
21	WEDNESDAY	Miladi Nabi HOLIDAY	
22	THURSDAY		63
23	FRIDAY		64
24	SATURDAY	Compensation for 07.11.2018	65
25	SUNDAY	HOLIDAY	
26	MONDAY		66
27	TUESDAY		67
28	WEDNESDAY		68
29	THURSDAY		69
30	FRIDAY		70

DECEMBER 2018

 PRINCIPAL
 K. S. R. INSTITUTE FOR
 ENGINEERING AND TECHNOLOGY
 K. S. R. KALVI NAGAR,
 TIRUCHENGODE-637 215,
 NAMAKKAL DL, TAMIL NADU.

Date	Day	Particulars	No. of Working Days
1	SATURDAY		71
2	SUNDAY	<i>HOLIDAY</i>	
3	MONDAY	<i>Internal Assessment- III S1</i>	72
4	TUESDAY	<i>S2</i>	73
5	WEDNESDAY	<i>S3</i>	74
6	THURSDAY	<i>S4</i>	75
7	FRIDAY	<i>S5</i>	76
8	SATURDAY	<i>S6</i>	77
9	SUNDAY	HOLIDAY	
10	MONDAY	<i>Last Instruction Day for I BE</i>	78
11	TUESDAY		
12	WEDNESDAY	<i>Commencement of University Practical Exams for BE</i>	
13	THURSDAY		
14	FRIDAY		
15	SATURDAY	<i>Last Instruction Day for I ME</i>	
16	SUNDAY	HOLIDAY	
17	MONDAY	<i>Commencement of University Practical Exams for ME</i>	
18	TUESDAY		
19	WEDNESDAY		
20	THURSDAY		
21	FRIDAY		
22	SATURDAY	<i>Compensation for 24.12.2018</i>	
23	SUNDAY	HOLIDAY	
24	MONDAY	HOLIDAY	
25	TUESDAY	<i>CHRISTMAS - HOLIDAY</i>	
26	WEDNESDAY		
27	THURSDAY		
28	FRIDAY		
29	SATURDAY	<i>Commencement of End Semester Exams for BE & ME</i>	
30	SUNDAY	HOLIDAY	
31	MONDAY	HOLIDAY	



PRINCIPAL,
K. S. R. INSTITUTE FOR
ENGINEERING AND TECHNOLOGY,
K. S. R. KALVI NAGAR,
TIRUCHENGODE-637 215,
NAMAKKAL Dt, TAMIL NADU.

ACADEMIC SCHEDULE REVISED

EVEN Semester (2018-19)

DEC 2018– APR 2019

PROGRAMME: B.E/B.Tech Degree

SEMESTER: VIII

S.No	Date(s)	Schedule
1.	19.12.2018	Commencement of Classes for 8 th semester BE/B.Tech & M.E/M.Tech
2.	19.01.2019	Completion of 2.5 Units for BE/B.Tech (23 working days)
3.	21.01.2019 – 24.01.2019	<i>Internal Assessment Test I for 8th semester BE/B.Tech & M.E/M.Tech (1.5 units)</i>
4.	02.02.2019	Completion of next 1.5 units (11 working days)
5.	04.02.2019 – 07.02.2019	<i>Internal Assessment Test II for 8th semester BE/B.Tech & M.E/M.Tech (1.5 units)</i>
6.	22.02.2019	Completion of next 1 unit (17 working days)
7.	23.02.2019 – 27.02.2019	<i>Internal Assessment Test III for 8th semester BE/B.Tech & M.E/M.Tech (2 units)</i>
8.	22.03.2019	Last Instruction day
9.	25.03.2019	Commencement of University Practical Exams
10.	08.04.2019	Commencement of End Semester Examinations for BE/B.Tech & M.E/M.Tech
11.	01.07.2019	Reopening for next semester

No. of Workings Days: 75

PRINCIPAL

PRINCIPAL,
K. S. R. INSTITUTE FOR
ENGINEERING AND TECHNOLOGY,
K. S. R. KALVINAGAR,
TIRUCHENGODE-637 215,
NAMAKKAL DL TAMIL NADU.

FEBRUARY 2019

Date	Day	Particulars	No. of Working Days
1	FRIDAY		33
2	SATURDAY	Monday Order	34
3	SUNDAY	HOLIDAY	
4	MONDAY	Internal Assessment-II S1	35
5	TUESDAY	S2	36
6	WEDNESDAY	S3	37
7	THURSDAY	S4	38
8	FRIDAY	Symposium*	39
9	SATURDAY	Symposium* Tuesday Order	40
10	SUNDAY	HOLIDAY	
11	MONDAY	Review 2 & submission of 1 & 2 chapters	41
12	TUESDAY		42
13	WEDNESDAY		43
14	THURSDAY	Sports Day*	44
15	FRIDAY	Annual day*	45
16	SATURDAY	Graduation day* Wednesday Order	46
17	SUNDAY	HOLIDAY	
18	MONDAY		47
19	TUESDAY		48
20	WEDNESDAY	Founder's Day	49
21	THURSDAY		50
22	FRIDAY		51
23	SATURDAY	Thursday Order Internal Assessment-III S1	52
24	SUNDAY	HOLIDAY	
25	MONDAY	S2	53
26	TUESDAY	S3	54
27	WEDNESDAY	S4	55
28	THURSDAY	Submission of 3 & 4 chapters	56

MARCH 2019

Date	Day	Particulars	No. of Working Days
1	FRIDAY		57
2	SATURDAY	Monday Order	58
3	SUNDAY	HOLIDAY	
4	MONDAY		59
5	TUESDAY		60
6	WEDNESDAY		61
7	THURSDAY		62
8	FRIDAY		63
9	SATURDAY	Conference* Tuesday Order	64
10	SUNDAY	HOLIDAY	
11	MONDAY	Project 100% Completed Demo & Project Report Submission rough copy	65
12	TUESDAY		66
13	WEDNESDAY		67
14	THURSDAY		68
15	FRIDAY		69
16	SATURDAY	Wednesday Order	70
17	SUNDAY	HOLIDAY	
18	MONDAY	PROJECT REPORT BONAFICATION & MODEL VIVA VOCE	71
19	TUESDAY		72
20	WEDNESDAY		73
21	THURSDAY		74
22	FRIDAY	Last Instruction Day	75
23	SATURDAY	HOLIDAY	
24	SUNDAY	HOLIDAY	
25	MONDAY	University Practical Examinations	
26	TUESDAY		
27	WEDNESDAY		
28	THURSDAY		
29	FRIDAY		
30	SATURDAY	HOLIDAY	
31	SUNDAY	HOLIDAY	

K. S. P. ENGINEERING COLLEGE
 P. THIRUCHENGERAI
 TIRUCHENGERAI, TAMIL NADU
 INDIA

08.04.2019 – University End Semester Examinations

ACADEMIC SCHEDULE

DECEMBER 2018

Date	Day	Particulars	No. of Working Days
1	SATURDAY		
2	SUNDAY	HOLIDAY	
3	MONDAY		
4	TUESDAY		
5	WEDNESDAY		
6	THURSDAY		
7	FRIDAY		
8	SATURDAY	HOLIDAY	
9	SUNDAY	HOLIDAY	
10	MONDAY		
11	TUESDAY		
12	WEDNESDAY		
13	THURSDAY		
14	FRIDAY		
15	SATURDAY		
16	SUNDAY		
17	MONDAY		
18	TUESDAY		
19	WEDNESDAY	<i>Commencement of Theory Classes for 8th Sem B.E/M.E</i>	1
20	THURSDAY		2
21	FRIDAY		3
22	SATURDAY	<i>Tuesday order</i>	4
23	SUNDAY	HOLIDAY	
24	MONDAY		5
25	TUESDAY	HOLIDAY - CHRISTMAS	
26	WEDNESDAY		6
27	THURSDAY		7
28	FRIDAY	<i>REVIEW 0</i>	8
29	SATURDAY	<i>Tuesday order</i>	9
30	SUNDAY	HOLIDAY	
	MONDAY		10

JANUARY 2019

Date	Day	Particulars	No. of Working Days
1	TUESDAY	NEW YEAR - HOLIDAY	
2	WEDNESDAY		11
3	THURSDAY		12
4	FRIDAY		13
5	SATURDAY	<i>Tuesday order</i>	14
6	SUNDAY	HOLIDAY	
7	MONDAY		15
8	TUESDAY		16
9	WEDNESDAY		17
10	THURSDAY		18
11	FRIDAY		19
12	SATURDAY	<i>Wednesday Order</i>	20
13	SUNDAY	HOLIDAY	
14	MONDAY		21
15	TUESDAY	PONGAL - HOLIDAY	
16	WEDNESDAY	THIRUVALLUVAR DAY - HOLIDAY	
17	THURSDAY	UZHAVARTHIRUNAL - HOLIDAY	
18	FRIDAY	<i>REVIEW 1</i>	22
19	SATURDAY	<i>Monday Order</i>	23
20	SUNDAY	HOLIDAY	
21	MONDAY	<i>Internal Assessment- I S1</i>	24
22	TUESDAY	<i>S2</i>	25
23	WEDNESDAY	<i>S3</i>	26
24	THURSDAY	<i>S4</i>	27
25	FRIDAY		28
26	SATURDAY	REPUBLIC DAY - HOLIDAY	
27	SUNDAY	HOLIDAY	
28	MONDAY		29
29	TUESDAY		30
30	WEDNESDAY		31
31	THURSDAY		32

 DEPUTY DEAN FOR
 ENGINEERING AND TECHNOLOGY,
 K. S. R. KALVI SAGAR,
 TIRUCHENGOORE-637 215,
 NAMAKKAL DL, TAMIL NADU.

ACADEMIC SCHEDULE

EVEN Semester (2018-19)

DEC 2018– APR 2019

PROGRAMME: B.E/B.Tech Degree

SEMESTER: IV & VI

PROGRAMME: M.E/M.Tech Degree

SEMESTER: IV

S.No	Date(s)	Schedule
1.	19.12.2018	Commencement of Classes for 4 th and 6 th semester BE/B.Tech & M.E/M.Tech
2.	31.01.2019	Completion of 2.5 Units for BE/B.Tech (34 working days)
3.	04.02.2019 – 09.02.2019	<i>Internal Assessment Test I for 4th and 6th semester BE/B.Tech & M.E/M.Tech (1.5 units)</i>
4.	22.02.2019	Completion of next 1.5 units (17 working days)
5.	23.02.2019 – 01.03.2019	<i>Internal Assessment Test II for 4th and 6th semester semester BE/B.Tech& M.E/M.Tech (1.5 units)</i>
6.	14.03.2019	Completion of next 1 unit (17 working days)
7.	15.03.2019 – 21.03.2019	<i>Internal Assessment Test III for 4th and 6th semester BE/B.Tech & M.E/M.Tech (2 units)</i>
8.	22.03.2019	Last Instruction day
9.	25.03.2019	Commencement of University Practical Exams
10.	08.04.2019	Commencement of End Semester Examinations for BE/B.Tech & M.E/M.Tech
11.	01.07.2019	Reopening for next semester

No. of Workings Days: 75

PRINCIPAL
K. S. R. INSTITUTE FOR
ENGINEERING AND TECHNOLOGY,
K. S. R. KALVA NAGAR,
TIRUCHENGODE 637 215,
NAMBARKAL DS, TAMIL NADU.

PRINCIPAL

ACADEMIC SCHEDULE

DECEMBER 2018

Date	Day	Particulars	No. of Working Days
1	SATURDAY		
2	SUNDAY	HOLIDAY	
3	MONDAY		
4	TUESDAY		
5	WEDNESDAY		
6	THURSDAY		
7	FRIDAY		
8	SATURDAY	HOLIDAY	
9	SUNDAY	HOLIDAY	
10	MONDAY		
11	TUESDAY		
12	WEDNESDAY		
13	THURSDAY		
14	FRIDAY		
15	SATURDAY		
16	SUNDAY		
17	MONDAY		
18	TUESDAY		
19	WEDNESDAY	Commencement of Theory Classes for 4 th 6 th & 8 th Sem B.E/M.E	1
20	THURSDAY		2
21	FRIDAY		3
22	SATURDAY	Tuesday order	4
23	SUNDAY	HOLIDAY	
24	MONDAY		5
25	TUESDAY	HOLIDAY - CHRISTMAS	
26	WEDNESDAY		6
27	THURSDAY		7
28	FRIDAY		8
29	SATURDAY	Tuesday order	9
30	SUNDAY	HOLIDAY	
31	MONDAY		10

JANUARY 2019

Date	Day	Particulars	No. of Working Days
1	TUESDAY	NEW YEAR - HOLIDAY	
2	WEDNESDAY		11
3	THURSDAY		12
4	FRIDAY		13
5	SATURDAY	Tuesday order	14
6	SUNDAY	HOLIDAY	
7	MONDAY		15
8	TUESDAY		16
9	WEDNESDAY		17
10	THURSDAY		18
11	FRIDAY		19
12	SATURDAY	Wednesday Order	20
13	SUNDAY	HOLIDAY	
14	MONDAY		21
15	TUESDAY	PONGAL - HOLIDAY	
16	WEDNESDAY	THIRUVALUVAR DAY - HOLIDAY	
17	THURSDAY	UZHAVARTHIRUNAL - HOLIDAY	
18	FRIDAY		22
19	SATURDAY	Monday Order	23
20	SUNDAY	HOLIDAY	
21	MONDAY		24
22	TUESDAY		25
23	WEDNESDAY		26
24	THURSDAY		27
25	FRIDAY		28
26	SATURDAY	REPUBLIC DAY - HOLIDAY	
27	SUNDAY	HOLIDAY	
28	MONDAY		29
29	TUESDAY		30
30	WEDNESDAY		31
31	THURSDAY		32

**M. S. M. INSTITUTE FOR
 ENGINEERING AND TECHNOLOGY**
 P. O. RAJANAGAR,
 TIRUCHENGODE 617 015,
 NAMKAL OF TAMIL NADU

FEBRUARY 2019

MARCH 2019

Date	Day	Particulars	No. of Working Days
1	FRIDAY		33
2	SATURDAY	Monday Order	34
3	SUNDAY	HOLIDAY	
4	MONDAY	Internal Assessment- I S1	35
5	TUESDAY	S2	36
6	WEDNESDAY	S3	37
7	THURSDAY	S4	38
8	FRIDAY	S5Symposium*	39
9	SATURDAY	S6Symposium* Tuesday Order	40
10	SUNDAY	HOLIDAY	
11	MONDAY		41
12	TUESDAY		42
13	WEDNESDAY		43
14	THURSDAY	Sports Day*	44
15	FRIDAY	Annual day*	45
16	SATURDAY	Graduation day* Wednesday Order	46
17	SUNDAY	HOLIDAY	
18	MONDAY		47
19	TUESDAY		48
20	WEDNESDAY	Founder's Day	49
21	THURSDAY		50
22	FRIDAY		51
23	SATURDAY	Thursday Order Internal Assessment- II S1	52
24	SUNDAY	HOLIDAY	
25	MONDAY	S2	53
26	TUESDAY	S3	54
27	WEDNESDAY	S4	55
28	THURSDAY	S5	56

Date	Day	Particulars	No. of Working Days
1	FRIDAY	S6	57
2	SATURDAY	Monday Order	58
3	SUNDAY	HOLIDAY	
4	MONDAY		59
5	TUESDAY		60
6	WEDNESDAY		61
7	THURSDAY		62
8	FRIDAY		63
9	SATURDAY	Conference* Tuesday Order	64
10	SUNDAY	HOLIDAY	
11	MONDAY		65
12	TUESDAY		66
13	WEDNESDAY		67
14	THURSDAY		68
15	FRIDAY	Internal Assessment- III S1	69
16	SATURDAY	S2 Wednesday Order	70
17	SUNDAY	HOLIDAY	
18	MONDAY	S3	71
19	TUESDAY	S4	72
20	WEDNESDAY	S5	73
21	THURSDAY	S6	74
22	FRIDAY	Last Instruction Day	75
23	SATURDAY	HOLIDAY	
24	SUNDAY	HOLIDAY	
25	MONDAY	University Practical Examinations	
26	TUESDAY		
27	WEDNESDAY		
28	THURSDAY		
29	FRIDAY		
30	SATURDAY	HOLIDAY	
31	SUNDAY	HOLIDAY	

08.04.2019 University End Semester Examinations
 ENGINEERING INSTITUTE FOR
 R. S. R. KALYANAGAR,
 TIRUCHENGODE-637 215,
 NAMAKKAL DI, TAMIL NADU.

ACADEMIC SCHEDULE

EVEN Semester (2018-19)

JAN 2018– MAY 2019

PROGRAMME: B.E/B.Tech Degree

SEMESTER: II

PROGRAMME: M.E/M.Tech Degree

SEMESTER: II

S.No	Date(s)	Schedule
1.	21.01.2019	Commencement of Classes for 2 nd semester BE/B.Tech & M.E/M.Tech
2.	27.02.2019	Completion of 2.5 Units for BE/B.Tech (32 working days)
3.	28.02.2019 – 06.03.2019	<i>Internal Assessment Test I for 2nd semester BE/B.Tech & M.E/M.Tech (1.5 units)</i>
4.	21.03.2019	Completion of next 1.5 units (19 working days)
5.	22.03.2019 – 28.03.2019	<i>Internal Assessment Test II for 2nd semester BE/B.Tech & M.E/M.Tech (1.5 units)</i>
6.	10.04.2019	Completion of next 1 unit (16 working days)
7.	11.04.2019 – 18.04.2019	<i>Internal Assessment Test III for 2nd semester BE/B.Tech & M.E/M.Tech (2 units)</i>
8.	22.04.2019	Last Instruction day
9.	24.04.2019	Commencement of University Practical Exams
10.	06.05.2019	Commencement of End Semester Examinations for BE/B.Tech & M.E/M.Tech
11.	01.07.2019	Reopening for next semester

No. of Workings Days: 75

PRINCIPAL,
K. S. R. INSTITUTE FOR
ENGINEERING AND TECHNOLOGY,
K. S. R. KALVI NAGAR,
TIRUCHENGODE-637 215,
NAMAKKAL DI, TAMIL NADU.

PRINCIPAL

ACADEMIC SCHEDULE

JANUARY 2019

Date	Day	Particulars	No. of Working Days
1	TUESDAY	NEW YEAR - HOLIDAY	
2	WEDNESDAY		
3	THURSDAY		
4	FRIDAY		
5	SATURDAY	Tuesday order	
6	SUNDAY	HOLIDAY	
7	MONDAY		
8	TUESDAY		
9	WEDNESDAY		
10	THURSDAY		
11	FRIDAY		
12	SATURDAY	Wednesday Order	
13	SUNDAY	HOLIDAY	
14	MONDAY		
15	TUESDAY	PONGAL - HOLIDAY	
16	WEDNESDAY	THIRUVALLUVAR DAY- HOLIDAY	
17	THURSDAY	UZHAVARTHIRUNAL - HOLIDAY	
18	FRIDAY		
19	SATURDAY	Monday Order	
20	SUNDAY	HOLIDAY	
21	MONDAY	Commencement of Theory Classes for 2 nd Sem B.E/M.E	1
22	TUESDAY		2
23	WEDNESDAY		3
24	THURSDAY		4
25	FRIDAY		5
26	SATURDAY	REPUBLIC DAY - HOLIDAY	
27	SUNDAY	HOLIDAY	
28	MONDAY		6
29	TUESDAY		7
30	WEDNESDAY		8
31	THURSDAY		9

FEBRUARY 2019

Date	Day	Particulars	No. of Working Days
1	FRIDAY		10
2	SATURDAY	Monday Order	11
3	SUNDAY	HOLIDAY	
4	MONDAY		12
5	TUESDAY		13
6	WEDNESDAY		14
7	THURSDAY		15
8	FRIDAY	Symposium*	16
9	SATURDAY	Symposium* Tuesday Order	17
10	SUNDAY	HOLIDAY	
11	MONDAY		18
12	TUESDAY		19
13	WEDNESDAY		20
14	THURSDAY	Sports Day*	21
15	FRIDAY	Annual day*	22
16	SATURDAY	Graduation day* Wednesday Order	23
17	SUNDAY	HOLIDAY	
18	MONDAY		24
19	TUESDAY		25
20	WEDNESDAY	Founder's Day	26
21	THURSDAY		27
22	FRIDAY		28
23	SATURDAY	Thursday Order	29
24	SUNDAY	HOLIDAY	
25	MONDAY		30
26	TUESDAY		31
27	WEDNESDAY		32
28	THURSDAY	Internal Assessment- I SI	33

 PRINCIPAL
 R. S. R. INSTITUTE FOR
 ENGINEERING AND TECHNOLOGY,
 R. S. R. KALVI NAGAR,
 TIRUCHENGODE-637 215,
 NAMAKKAL DI, TAMIL NADU.

MARCH 2019

APRIL 2019

Date	Day	Particulars	No. of Working Days
1	FRIDAY	S2	34
2	SATURDAY	S3 Monday Order	35
3	SUNDAY	HOLIDAY	
4	MONDAY	S4	36
5	TUESDAY	S5	37
6	WEDNESDAY	S6	38
7	THURSDAY		39
8	FRIDAY		40
9	SATURDAY	Conference* Tuesday Order	41
10	SUNDAY	HOLIDAY	
11	MONDAY		42
12	TUESDAY		43
13	WEDNESDAY		44
14	THURSDAY		45
15	FRIDAY		46
16	SATURDAY	Wednesday Order	47
17	SUNDAY	HOLIDAY	
18	MONDAY		48
19	TUESDAY		49
20	WEDNESDAY		50
21	THURSDAY		51
22	FRIDAY	Internal Assessment-II SI	52
23	SATURDAY	S2 Friday Order	53
24	SUNDAY	HOLIDAY	
25	MONDAY	S3	54
26	TUESDAY	S4	55
27	WEDNESDAY	S5	56
28	THURSDAY	S6	57
29	FRIDAY		58
30	SATURDAY	Monday Order	59
31	SUNDAY	HOLIDAY	

Date	Day	Particulars	No. of Working Days
1	MONDAY		60
2	TUESDAY		61
3	WEDNESDAY		62
4	THURSDAY		63
5	FRIDAY		64
6	SATURDAY	TELUGU NEW YEAR - HOLIDAY	
7	SUNDAY	HOLIDAY	
8	MONDAY		65
9	TUESDAY		66
10	WEDNESDAY		67
11	THURSDAY	Internal Assessment-III SI	68
12	FRIDAY	S2	69
13	SATURDAY	S3 Wednesday Order	70
14	SUNDAY	TAMIL NEW YEAR- Dr.AMBEDKAR BIRTHDAY- HOLIDAY	
15	MONDAY	S4	71
16	TUESDAY	S5	72
17	WEDNESDAY	MAHAVEER JAYANTHI - HOLIDAY	
18	THURSDAY	S6	73
19	FRIDAY	GOOD FRIDAY - HOLIDAY	
20	SATURDAY	Friday Order	74
21	SUNDAY	HOLIDAY	
22	MONDAY	Last Instruction Day	75
23	TUESDAY		
24	WEDNESDAY	University Practical Examinations	
25	THURSDAY		
26	FRIDAY		
27	SATURDAY	HOLIDAY	
28	SUNDAY	HOLIDAY	
29	MONDAY		
30	TUESDAY		



06.05.2019 - University End Semester Examinations

PRINCIPAL,
K. S. R. INSTITUTE FOR
ENGINEERING AND TECHNOLOGY,
K. S. R. KALVI NAGAR,
TIRUCHENGODE-637 215,
NAMAKKAL DL, TAMIL NADU.

K S R INSTITUTE FOR ENGINEERING AND TECHNOLOGY TIRUCHENGODE – 637 215.

ACADEMIC SCHEDULE REVISED

ODD Semester (2019-20)

JUN 2019– DEC 2019

PROGRAMME: B.E/B.Tech Degree

SEMESTER: III, V & VII

PROGRAMME: M.E/M.Tech Degree

SEMESTER: III

S.No	Date(s)	Schedule
1.	24.06.2019	Commencement of Theory Classes for 3 rd , 5 th & 7 th Semester B.E & M.E
2.	12.07.2019	Completion of 1.5 Units for BE & ME (17 working days)
3.	15.07.2019 – 20.07.2019	Internal Assessment Test I for all UG & PG Except I year (1 unit)
4.	22.08.2019	Completion of 2 Units (23 working days)
5.	26.08.2019 – 31.08.2019	Internal Assessment Test II for all UG & PG Except I year (2 units)
6.	21.09.2019	Completion of 1.5 Units (15 working days)
7.	23.09.2019 – 30.09.2019	Internal Assessment Test III for all UG & PG Except I year (2 units)
8.	01.10.2019	Revision commences
9.	19.10.2019	Last Instruction Day for B.E
10.	21.10.2019	Commencement of University Practical Exams
11.	06.11.2019	Commencement of End Semester Examinations for BE
12.	16.12.2019	Reopening for next semester

No. of Workings Days: 87

PRINCIPAL
 K. S. R. INSTITUTE FOR
 ENGINEERING AND TECHNOLOGY,
 K. S. R. NAGAR,
 TIRUCHENGODE-637 215,
 NAMAKKAL DI, TAMIL NADU.

PRINCIPAL

ACADEMIC SCHEDULE

JUNE 2019

JULY 2019

Date	Day	Particulars	No. of Working Days
1	SATURDAY	HOLIDAY	
2	SUNDAY	HOLIDAY	
3	MONDAY		
4	TUESDAY		
5	WEDNESDAY	RAMZAN - HOLIDAY	
6	THURSDAY		
7	FRIDAY		
8	SATURDAY	HOLIDAY	
9	SUNDAY	HOLIDAY	
10	MONDAY	Commencement of Training Classes for 7 th Sem B.E	
11	TUESDAY		
12	WEDNESDAY		
13	THURSDAY		
14	FRIDAY		
15	SATURDAY	HOLIDAY	
16	SUNDAY	HOLIDAY	
17	MONDAY	Commencement of Training Classes for 3 rd & 5 th Sem B.E	
18	TUESDAY		
19	WEDNESDAY		
20	THURSDAY		
21	FRIDAY		
22	SATURDAY	HOLIDAY	
23	SUNDAY	HOLIDAY	
24	MONDAY	Commencement of Theory Classes for 3 rd , 5 th & 7 th Sem B.E & M.E	1
25	TUESDAY		2
26	WEDNESDAY		3
27	THURSDAY		4
28	FRIDAY		5
29	SATURDAY		6
30	SUNDAY		

Date	Day	Particulars	No. of Working Days
1	MONDAY		7
2	TUESDAY		8
3	WEDNESDAY		9
4	THURSDAY		10
5	FRIDAY		11
6	SATURDAY		12
7	SUNDAY	HOLIDAY	
8	MONDAY		13
9	TUESDAY		14
10	WEDNESDAY		15
11	THURSDAY		16
12	FRIDAY		17
13	SATURDAY	SECOND SATURDAY - HOLIDAY	
14	SUNDAY	HOLIDAY	
15	MONDAY	Internal Assessment - I S1	18
16	TUESDAY	S2	19
17	WEDNESDAY	S3	20
18	THURSDAY	S4	21
19	FRIDAY	S5	22
20	SATURDAY	S6	23
21	SUNDAY	HOLIDAY	
22	MONDAY		24
23	TUESDAY		25
24	WEDNESDAY		26
25	THURSDAY		27
26	FRIDAY		28
27	SATURDAY	FOURTH SATURDAY - HOLIDAY	
28	SUNDAY	HOLIDAY	
29	MONDAY		29
30	TUESDAY		30
31	WEDNESDAY		31

 PRINCIPAL
 K. S. R. INSTITUTE FOR
 ENGINEERING AND TECHNOLOGY,
 K. S. R. NAGAR,
 TIRUCHENGODE-637 215,
 NAMAKKAL Dt., TAMIL NADU.

AUGUST 2019

Date	Day	Particulars	No. of Working Days
1	THURSDAY		32
2	FRIDAY		33
3	SATURDAY	AADI PERUKKU HOLIDAY	
4	SUNDAY	HOLIDAY	
5	MONDAY		34
6	TUESDAY		35
7	WEDNESDAY		36
8	THURSDAY		37
9	FRIDAY		38
10	SATURDAY	SECOND SATURDAY-HOLIDAY	
11	SUNDAY	HOLIDAY	
12	MONDAY	BAKRID - HOLIDAY	
13	TUESDAY		39
14	WEDNESDAY		40
15	THURSDAY	INDEPENDENCE DAY - HOLIDAY	
16	FRIDAY		41
17	SATURDAY		42
18	SUNDAY	HOLIDAY	
19	MONDAY		43
20	TUESDAY		44
21	WEDNESDAY		45
22	THURSDAY		46
23	FRIDAY	KRISHNA JAYANTHI - HOLIDAY	
24	SATURDAY	FOURTH SATURDAY - HOLIDAY	
25	SUNDAY	HOLIDAY	
26	MONDAY	Internal Assessment- II SI	47
27	TUESDAY	S2	48
28	WEDNESDAY	S3	49
29	THURSDAY	S4	50
30	FRIDAY	S5	51
31	SATURDAY	S6	52

SEPTEMBER 2019

Date	Day	Particulars	No. of Working Days
1	SUNDAY	HOLIDAY	
2	MONDAY	VINAYAKAR CHATHURTHI - HOLIDAY	
3	TUESDAY		53
4	WEDNESDAY		54
5	THURSDAY		55
6	FRIDAY		56
7	SATURDAY		57
8	SUNDAY	HOLIDAY	
9	MONDAY		58
10	TUESDAY	MOHARRAM - HOLIDAY	
11	WEDNESDAY		59
12	THURSDAY		60
13	FRIDAY		61
14	SATURDAY	SECOND SATURDAY - HOLIDAY	
15	SUNDAY	HOLIDAY	
16	MONDAY		62
17	TUESDAY		63
18	WEDNESDAY		64
19	THURSDAY		65
20	FRIDAY		66
21	SATURDAY		67
22	SUNDAY	HOLIDAY	
23	MONDAY	Internal Assessment- III SI	68
24	TUESDAY	S2	69
25	WEDNESDAY	S3	70
26	THURSDAY	S4	71
27	FRIDAY	S5	72
28	SATURDAY	FOURTH SATURDAY - HOLIDAY	
29	SUNDAY	HOLIDAY	
30	MONDAY	S6	73

PRINCIPAL,
K. S. R. INSTITUTE FOR
ENGINEERING AND TECHNOLOGY,
K. S. R. KALVI NAGAR,
TIRUCHENGODE-637 215,
NAMAKKAL DL, TAMIL NADU.

OCTOBER 2019

Date	Day	Particulars	No. of Working Days
1	TUESDAY	Model Exam/Revision	74
2	WEDNESDAY	GANDHI JAYANTHI - HOLIDAY	
3	THURSDAY	S1	75
4	FRIDAY		76
5	SATURDAY		77
6	SUNDAY	HOLIDAY	
7	MONDAY	SARASWATHI POOJA - HOLIDAY	
8	TUESDAY	VIJAYA DASAMI - HOLIDAY	
9	WEDNESDAY	S2	78
10	THURSDAY		79
11	FRIDAY	S3	80
	SATURDAY	Compensation for 28.10.2019	81
13	SUNDAY	HOLIDAY	
14	MONDAY	S4	82
15	TUESDAY		83
16	WEDNESDAY	S5	84
17	THURSDAY		85
18	FRIDAY	S6	86
19	SATURDAY	Model Lab Last Instruction Day for BE& ME	87
20	SUNDAY	HOLIDAY	
21	MONDAY	University End Sem Practical Examinations	
22	TUESDAY		
23	WEDNESDAY		
24	THURSDAY		
	FRIDAY		
26	SATURDAY	FOURTH SATURDAY - HOLIDAY	
27	SUNDAY	DEEPAVALI - HOLIDAY	
28	MONDAY	HOLIDAY	
29	TUESDAY		
30	WEDNESDAY		
31	THURSDAY		

*Subjected to change

NOVEMBER 2019

Date	Day	Particulars	No. of Working Days
1	FRIDAY		
2	SATURDAY		
3	SUNDAY	HOLIDAY	
4	MONDAY		
5	TUESDAY		
6	WEDNESDAY	University End Sem Theory Examinations for BE& ME	
7	THURSDAY		
8	FRIDAY		
9	SATURDAY	SECOND SATURDAY - HOLIDAY	
10	SUNDAY	MILADI NABI - HOLIDAY	
11	MONDAY		
12	TUESDAY		
13	WEDNESDAY		
14	THURSDAY		
15	FRIDAY		
16	SATURDAY		
17	SUNDAY	HOLIDAY	
18	MONDAY		
19	TUESDAY		
20	WEDNESDAY		
21	THURSDAY		
22	FRIDAY		
23	SATURDAY	FOURTH SATURDAY - HOLIDAY	
24	SUNDAY	HOLIDAY	
25	MONDAY		
26	TUESDAY		
27	WEDNESDAY		
28	THURSDAY		
29	FRIDAY		
30	SATURDAY		

K. S. R. INSTITUTION FOR ENGINEERING AND TECHNOLOGY,
K. S. R. NAGAR,
THIRUCHENKURAI 613 215,
NAGARAVELU, TAMIL NADU.

K S R INSTITUTE FOR ENGINEERING AND TECHNOLOGY TIRUCHENGODE – 637 215.

ACADEMIC SCHEDULE REVISED

ODD Semester (2019-20)

JUN 2019– DEC 2019

PROGRAMME: B.E/B.Tech Degree

SEMESTER: I

PROGRAMME: M.E/M.Tech Degree

SEMESTER: I

S.No	Date(s)	Schedule
1.	22.07.2019	Commencement of Classes for 1 st Semester B.E & M.E
2.	05.08.2019	Commencement of Theory Classes for 1 st Semester B.E & M.E
3.	31.08.2019	Completion of 1.5 Units for BE & ME (19 working days)
4.	03.09.2019 – 09.09.2019	Internal Assessment Test I for 1 year UG & PG (1unit)
5.	01.10.2019	Completion of 2 Units (22 working days)
6.	03.10.2019 – 12.10.2019	Internal Assessment Test II for 1 year UG & PG (2units)
7.	19.10.2019	Completion of 1.5Units (12 working days)
8.	30.10.2019 – 05.11.2019	Internal Assessment Test III for 1 year UG & PG. (2 units)
9.	06.11.2019	Revision commences
10.	20.11.2019	Last Instruction Day for B.E
11.	22.11.2019	Commencement of University Practical Exams
12.	04.12.2019	Commencement of End Semester Examinations for BE
13.	06.01.2020	Reopening for next semester*

No. of Workings Days: 78

 PRINCIPAL
 K. S. R. INSTITUTE FOR
 ENGINEERING AND TECHNOLOGY,
 K. S. R. KATTA NAGAR,
 TIRUCHENGODE-637 215,
 NAMAVAL DE TALUK, NADU.

 PRINCIPAL

ACADEMIC SCHEDULE

JULY 2019

AUGUST 2019

Date	Day	Particulars	No. of Working Days
1	MONDAY		
2	TUESDAY		
3	WEDNESDAY		
4	THURSDAY		
5	FRIDAY		
6	SATURDAY		
7	SUNDAY	HOLIDAY	
8	MONDAY		
9	TUESDAY		
10	WEDNESDAY		
11	THURSDAY		
12	FRIDAY		
13	SATURDAY	SECOND SATURDAY-HOLIDAY	
14	SUNDAY	HOLIDAY	
15	MONDAY		
16	TUESDAY		
17	WEDNESDAY		
18	THURSDAY		
19	FRIDAY		
20	SATURDAY		
21	SUNDAY	HOLIDAY	
22	MONDAY	Commencement of Bridge course for 1 st Sem B.E	
23	TUESDAY		
24	WEDNESDAY		
25	THURSDAY		
26	FRIDAY		
27	SATURDAY	FOURTH SATURDAY - HOLIDAY	
28	SUNDAY	HOLIDAY	
29	MONDAY		
30	TUESDAY		
31	WEDNESDAY		

Date	Day	Particulars	No. of Working Days
1	THURSDAY		
2	FRIDAY		
3	SATURDAY	AADI PERUKKU HOLIDAY	
4	SUNDAY	HOLIDAY	
5	MONDAY	Commencement of Theory Classes for 1 st Sem B.E	1
6	TUESDAY		2
7	WEDNESDAY		3
8	THURSDAY		4
9	FRIDAY		5
10	SATURDAY	SECOND SATURDAY-HOLIDAY	
11	SUNDAY	HOLIDAY	
12	MONDAY	BAKRID - HOLIDAY	
13	TUESDAY		6
14	WEDNESDAY		7
15	THURSDAY	INDEPENDENCE DAY - HOLIDAY	
16	FRIDAY		8
17	SATURDAY		9
18	SUNDAY	HOLIDAY	
19	MONDAY		10
20	TUESDAY		11
21	WEDNESDAY		12
22	THURSDAY		13
23	FRIDAY	KRISHNA JAYANTHI - HOLIDAY	
24	SATURDAY	FOURTH SATURDAY - HOLIDAY	
25	SUNDAY	HOLIDAY	
26	MONDAY		14
27	TUESDAY		15
28	WEDNESDAY		16
29	THURSDAY		17
30	FRIDAY		18
31	SATURDAY		19

 PRINCIPAL
 K. S. R. INSTITUTE FOR
 ENGINEERING AND TECHNOLOGY,
 K. S. S. KALYAN NAGAR,
 TIRUCHENGOORE - 613 015,
 TAMIL NADU.

SEPTEMBER 2019

Date	Day	Particulars	No. of Working Days
1	SUNDAY	HOLIDAY	
2	MONDAY	VINAYAKAR CHATHURTHI - HOLIDAY	
3	TUESDAY	Internal Assessment- I SI	20
4	WEDNESDAY	S2	21
5	THURSDAY	S3	22
6	FRIDAY	S4	23
7	SATURDAY	S5	24
8	SUNDAY	HOLIDAY	
9	MONDAY	S6	25
10	TUESDAY	MOHARRAM- HOLIDAY	
11	WEDNESDAY		26
12	THURSDAY		27
13	FRIDAY		28
14	SATURDAY	SECOND SATURDAY- HOLIDAY	
15	SUNDAY	HOLIDAY	
16	MONDAY		29
17	TUESDAY		30
18	WEDNESDAY		31
19	THURSDAY		32
20	FRIDAY		33
21	SATURDAY		34
22	SUNDAY	HOLIDAY	
23	MONDAY		35
24	TUESDAY		36
25	WEDNESDAY		37
26	THURSDAY		38
27	FRIDAY		39
28	SATURDAY	FOURTH SATURDAY - HOLIDAY	
29	SUNDAY	HOLIDAY	
30	MONDAY		40

OCTOBER 2019

Date	Day	Particulars	No. of Working Days
1	TUESDAY		41
2	WEDNESDAY	GANDHI JAYANTHI - HOLIDAY	
3	THURSDAY	Internal Assessment- II SI	42
4	FRIDAY	S2	43
5	SATURDAY		44
6	SUNDAY	HOLIDAY	
7	MONDAY	SARASWATHI POOJA - HOLIDAY	
8	TUESDAY	VIJAYA DASAMI - HOLIDAY	
9	WEDNESDAY	S3	45
10	THURSDAY	S4	46
11	FRIDAY	S5	47
12	SATURDAY	S6 Compensation for 28.10.2019	48
13	SUNDAY	HOLIDAY	
14	MONDAY		49
15	TUESDAY		50
16	WEDNESDAY		51
17	THURSDAY		52
18	FRIDAY		53
19	SATURDAY		54
20	SUNDAY	HOLIDAY	
21	MONDAY		55
22	TUESDAY		56
23	WEDNESDAY		57
24	THURSDAY		58
25	FRIDAY		59
26	SATURDAY	FOURTH SATURDAY - HOLIDAY	
27	SUNDAY	DEEPAVALI - HOLIDAY	
28	MONDAY	HOLIDAY	
29	TUESDAY		60
30	WEDNESDAY	Internal Assessment- III SI	61
31	THURSDAY	S2	62

 PRINCIPAL,
 K. S. R. INSTITUTE FOR
 ENGINEERING AND TECHNOLOGY,
 K. S. R. KALVI NAGAR,
 TIRUCHENGODE-637 215,
 NAMAKKAL DI, TAMIL NADU.

NOVEMBER 2019

Date	Day	Particulars	No. of Working Days
1	FRIDAY	S3	63
2	SATURDAY	S4	64
3	SUNDAY		
4	MONDAY	S5	65
5	TUESDAY	S6	66
6	WEDNESDAY	Model Exams/Revision	67
7	THURSDAY	S1	68
8	FRIDAY		69
9	SATURDAY	SECOND SATURDAY-HOLIDAY	
10	SUNDAY	MILADI NABI-HOLIDAY	
11	MONDAY	S2	70
12	TUESDAY		71
13	WEDNESDAY	S3	72
14	THURSDAY		73
15	FRIDAY	S4	74
16	SATURDAY		75
17	SUNDAY	HOLIDAY	
18	MONDAY	S5	76
19	TUESDAY		77
20	WEDNESDAY	S6 Last Instruction Day for BE & ME*	78
21	THURSDAY		
22	FRIDAY	University Practical Examinations	
23	SATURDAY	FOURTH SATURDAY-HOLIDAY	
24	SUNDAY	HOLIDAY	
25	MONDAY		
26	TUESDAY		
27	WEDNESDAY		
28	THURSDAY		
29	FRIDAY		
30	SATURDAY		

DECEMBER 2019

Date	Day	Particulars	No. of Working Days
1	SUNDAY	HOLIDAY	
2	MONDAY		
3	TUESDAY		
4	WEDNESDAY	University End Sem Theory Examinations for J BE & ME*	
5	THURSDAY		
6	FRIDAY		
7	SATURDAY		
8	SUNDAY	HOLIDAY	
9	MONDAY		
10	TUESDAY		
11	WEDNESDAY		
12	THURSDAY		
13	FRIDAY		
14	SATURDAY	SECOND SATURDAY-HOLIDAY	
15	SUNDAY	HOLIDAY	
16	MONDAY		
17	TUESDAY		
18	WEDNESDAY		
19	THURSDAY		
20	FRIDAY		
21	SATURDAY		
22	SUNDAY	HOLIDAY	
23	MONDAY		
24	TUESDAY		
25	WEDNESDAY	CHRISTMAS-HOLIDAY	
26	THURSDAY		
27	FRIDAY		
28	SATURDAY	FOURTH SATURDAY-HOLIDAY	
29	SUNDAY	HOLIDAY	
30	MONDAY		
31	TUESDAY		

*Subjected to change

PRINCIPAL,
K. J. S. INSTITUTE FOR
ENGINEERING AND TECHNOLOGY,
K. J. S. ROAD,
TUMKUR - 575 015,
KARNATAKA.

K S R INSTITUTE FOR ENGINEERING AND TECHNOLOGY TIRUCHENGODE – 637 215.

ACADEMIC SCHEDULE

EVEN Semester (2019-20)

DEC 2019– APR 2020

PROGRAMME: B.E/B.Tech Degree

SEMESTER: IV, VI & VIII

PROGRAMME: M.E/M.Tech Degree

SEMESTER: IV

S.No	Date(s)	Schedule
1.	09.12.2019	Commencement of Classes for 4 th and 6 th semester BE/B.Tech & M.E/M.Tech
2.	12.12.2019	Commencement of Classes for 8 th semester BE/B.Tech
3.	25.01.2020	Completion of 2 Units for BE/B.Tech (28 working days)
4.	27.01.2020 – 01.02.2020	Internal Assessment Test I for 4 th , 6 th and 8 th semester BE/B.Tech & M.E/M.Tech (2 units)
5.	29.02.2020	Completion of next 2 units (23 working days)
6.	02.03.2020 – 07.03.2020	Internal Assessment Test II for 4 th , 6 th and 8 th semester BE/B.Tech & M.E/M.Tech (2 units)
7.	13.03.2020	Completion of next 1 unit (8 working days)
8.	18.03.2020 – 24.03.2020	Internal Assessment Test III for 4 th , 6 th and 8 th semester BE/B.Tech & M.E/M.Tech (1 unit)
9.	27.03.2020	Last Instruction day
10.	30.03.2020	Commencement of University Practical Exams
11.	17.04.2020	Commencement of End Semester Examinations for BE/B.Tech & M.E/M.Tech
12.	01.07.2020	Reopening for next semester

No. of Workings Days: 80

 PRINCIPAL

 PRINCIPAL
 K. S. R. INSTITUTE FOR
 ENGINEERING AND TECHNOLOGY,
 K. S. R. KALVI NAGAR,
 TIRUCHENGODE-637 215,
 NAMAKKAL Dt., TAMIL NADU

ACADEMIC SCHEDULE

DECEMBER 2019

Date	Day	Particulars	No. of Working Days
1	SUNDAY	HOLIDAY	
2	MONDAY		
3	TUESDAY		
4	WEDNESDAY		
5	THURSDAY		
6	FRIDAY		
7	SATURDAY		
8	SUNDAY	HOLIDAY	
9	MONDAY	Commencement of Theory Classes for 4 th & 6 th Sem B.E/M.E	1
10	TUESDAY		2
11	WEDNESDAY		3
12	THURSDAY	Commencement of Theory Classes for 8 th Sem B.E	4
13	FRIDAY		5
14	SATURDAY	HOLIDAY	
15	SUNDAY	HOLIDAY	
16	MONDAY		6
17	TUESDAY		7
18	WEDNESDAY		8
19	THURSDAY		9
20	FRIDAY		10
21	SATURDAY		11
22	SUNDAY	HOLIDAY	
23	MONDAY	Govt declared holiday	
24	TUESDAY	Govt declared holiday	
25	WEDNESDAY	HOLIDAY - CHRISTMAS	
26	THURSDAY	Govt declared holiday	
27	FRIDAY	Govt declared holiday	
28	SATURDAY	HOLIDAY	
29	SUNDAY	HOLIDAY	
30	MONDAY	Govt declared holiday	
31	TUESDAY	Govt declared holiday	

JANUARY 2020

Date	Day	Particulars	No. of Working Days
1	WEDNESDAY	NEW YEAR - HOLIDAY	
2	THURSDAY		12
3	FRIDAY		13
4	SATURDAY		14
5	SUNDAY	HOLIDAY	
6	MONDAY		15
7	TUESDAY		16
8	WEDNESDAY		17
9	THURSDAY		18
10	FRIDAY		19
11	SATURDAY	Compensation for 21.12.19	20
12	SUNDAY	HOLIDAY	
13	MONDAY		21
14	TUESDAY	Compensation for 23.12.19	22
15	WEDNESDAY	PONGAL - HOLIDAY	
16	THURSDAY	THIRUVALLUVAR DAY - HOLIDAY	
17	FRIDAY	UZHAVARTHIRUNAL - HOLIDAY	
18	SATURDAY	HOLIDAY	
19	SUNDAY	HOLIDAY	
20	MONDAY		23
21	TUESDAY		24
22	WEDNESDAY		25
23	THURSDAY		26
24	FRIDAY		27
25	SATURDAY	Compensation for 18.01.20	28
26	SUNDAY	REPUBLIC DAY - HOLIDAY	
27	MONDAY	Internal Assessment- I S1	29
28	TUESDAY	S2	30
29	WEDNESDAY	S3	31
30	THURSDAY	S4	32
31	FRIDAY	S5	33

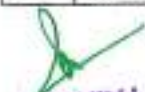

PRINCIPAL,
K. S. R. INSTITUTE FOR
ENGINEERING AND TECHNOLOGY,
K. S. R. KALVI NAGAR,
TIRUCHENGODE-637 215,
NAMAKKAL DI. TAMIL NADU.

FEBRUARY 2020

Date	Day	Particulars	No. of Working Days
1	SATURDAY	S6	34
2	SUNDAY	HOLIDAY	
3	MONDAY		35
4	TUESDAY		36
5	WEDNESDAY		37
6	THURSDAY		38
7	FRIDAY		39
8	SATURDAY	Compensation for 24.12.19	40
9	SUNDAY	HOLIDAY	
10	MONDAY		41
11	TUESDAY		42
12	WEDNESDAY		43
13	THURSDAY		44
14	FRIDAY		45
15	SATURDAY		46
16	SUNDAY	HOLIDAY	
17	MONDAY		47
18	TUESDAY		48
19	WEDNESDAY		49
20	THURSDAY	Founder's Day	
21	FRIDAY		50
22	SATURDAY	Compensation for 26.12.19	51
23	SUNDAY	HOLIDAY	
24	MONDAY		52
25	TUESDAY		53
26	WEDNESDAY	Conference*	54
27	THURSDAY		55
28	FRIDAY		56
29	SATURDAY		57

MARCH 2020

Date	Day	Particulars	No. of Working Days
1	SUNDAY	HOLIDAY	
2	MONDAY	Internal assessment II S1	58
3	TUESDAY	S2	59
4	WEDNESDAY	S3	60
5	THURSDAY	S4	61
6	FRIDAY	S5	62
7	SATURDAY	S6	63
8	SUNDAY	HOLIDAY	
9	MONDAY		64
10	TUESDAY		65
11	WEDNESDAY		66
12	THURSDAY		67
13	FRIDAY		68
14	SATURDAY	Compensation for 27.12.19	69
15	SUNDAY	HOLIDAY	
16	MONDAY		70
17	TUESDAY		71
18	WEDNESDAY	Internal assessment III S1	72
19	THURSDAY	S2	73
20	FRIDAY	S3	74
21	SATURDAY	S4	75
22	SUNDAY	HOLIDAY	
23	MONDAY	S5	77
24	TUESDAY	S6	78
25	WEDNESDAY	TELUGU NEW YEAR HOLIDAY	
26	THURSDAY		79
27	FRIDAY	Last Instruction Day	80
28	SATURDAY	Compensation for 30.12.19	
29	SUNDAY	HOLIDAY	
30	MONDAY	University Practical Examinations	
31	TUESDAY		



 PRINCIPAL,
 K. S. V. INSTITUTE FOR
 ENGINEERING AND TECHNOLOGY,
 K. S. RAOJI NAGAR,
 TIRUCHENGODE-637-215,
 NAMAKKAL DISTRICT, TAMIL NADU.

APRIL 2020

MAY 2020

Date	Day	Particulars	No. of Working Days
1	WEDNESDAY		
2	THURSDAY		
3	FRIDAY		
4	SATURDAY		
5	SUNDAY	HOLIDAY	
6	MONDAY	MAHAVEER JAYANTHI - HOLIDAY	
7	TUESDAY		
8	WEDNESDAY		
9	THURSDAY		
10	FRIDAY	GOOD FRIDAY - HOLIDAY	
11	SATURDAY	Compensation for 31.12.19	
12	SUNDAY	HOLIDAY	
13	MONDAY		
14	TUESDAY	TAMIL NEW YEAR- Dr. AMBEDKAR BIRTHDAY- HOLIDAY	
15	WEDNESDAY		
16	THURSDAY		
17	FRIDAY	University End Sem Examinations*	
18	SATURDAY	HOLIDAY	
19	SUNDAY	HOLIDAY	
20	MONDAY		
21	TUESDAY		
22	WEDNESDAY		
23	THURSDAY		
24	FRIDAY		
25	SATURDAY	HOLIDAY	
26	SUNDAY	HOLIDAY	
27	MONDAY		
28	TUESDAY		
29	WEDNESDAY		
30	THURSDAY		

Date	Day	Particulars	No. of Working Days
1	FRIDAY	MAY DAY - HOLIDAY	
2	SATURDAY	HOLIDAY	
3	SUNDAY	HOLIDAY	
4	MONDAY		
5	TUESDAY		
6	WEDNESDAY		
7	THURSDAY		
8	FRIDAY		
9	SATURDAY	HOLIDAY	
10	SUNDAY	HOLIDAY	
11	MONDAY		
12	TUESDAY		
13	WEDNESDAY		
14	THURSDAY		
15	FRIDAY		
16	SATURDAY	HOLIDAY	
17	SUNDAY	HOLIDAY	
18	MONDAY		
19	TUESDAY		
20	WEDNESDAY		
21	THURSDAY		
22	FRIDAY		
23	SATURDAY	HOLIDAY	
24	SUNDAY	HOLIDAY	
25	MONDAY		
26	TUESDAY		
27	WEDNESDAY		
28	THURSDAY		
29	FRIDAY		
30	SATURDAY	HOLIDAY	
31	SUNDAY	HOLIDAY	

PRINCIPAL,
K. S. R. INSTITUTE FOR
ENGINEERING AND TECHNOLOGY,
K. S. R. KALVI NAGAR,
TIRUCHENGODE-637 215,
NAMAKKAL Dt, TAMIL NADU.

K S R INSTITUTE FOR ENGINEERING AND TECHNOLOGY, TIRUCHENGODE – 637 215.

ACADEMIC SCHEDULE

EVEN Semester (2019-20)

DEC 2019– APR 2020

PROGRAMME: B.E/B.Tech Degree

SEMESTER: II

PROGRAMME: M.E/M.Tech Degree

SEMESTER: II

S.No	Date(s)	Schedule
1.	06.01.2020	Commencement of Classes for 2 nd semester BE/B.Tech & M.E/M.Tech
2.	07.02.2020	Completion of 2 Units for BE/B.Tech (26 working days)
3.	10.02.2020 – 15.02.2020	Internal Assessment Test I for 2 nd semester BE/B.Tech & M.E/M.Tech (2 units)
4.	19.03.2020	Completion of next 2 units (27 working days)
5.	20.03.2020 – 27.03.2020	Internal Assessment Test II for 2 nd semester BE/B.Tech & M.E/M.Tech (2 units)
6.	08.04.2020	Completion of next 1 unit (9 working days)
7.	09.04.2020 – 17.04.2020	Internal Assessment Test III for 2 nd semester BE/B.Tech & M.E/M.Tech (1 unit)
8.	17.04.2020	Last Instruction day
9.	20.04.2020	Commencement of University Practical Exams
10.	04.05.2020	Commencement of End Semester Examinations for BE/B.Tech & M.E/M.Tech
11.	01.07.2020	Reopening for next semester

No. of Workings Days: 81



PRINCIPAL



PRINCIPAL,
K. S. R. INSTITUTE FOR
ENGINEERING AND TECHNOLOGY,
K. S. R. KALVIN Nagar,
TIRUCHENGODE - 637 215,
NAMAKKAL DL TAMIL NADU.

ACADEMIC SCHEDULE

DECEMBER 2019

Date	Day	Particulars	No. of Working Days
1	SUNDAY	HOLIDAY	
2	MONDAY		
3	TUESDAY		
4	WEDNESDAY		
5	THURSDAY		
6	FRIDAY		
7	SATURDAY		
8	SUNDAY	HOLIDAY	
9	MONDAY		
10	TUESDAY		
11	WEDNESDAY		
12	THURSDAY		
13	FRIDAY		
14	SATURDAY	HOLIDAY	
15	SUNDAY	HOLIDAY	
16	MONDAY		
17	TUESDAY		
18	WEDNESDAY		
19	THURSDAY		
20	FRIDAY		
21	SATURDAY		
22	SUNDAY	HOLIDAY	
23	MONDAY		
24	TUESDAY		
25	WEDNESDAY	HOLIDAY - CHRISTMAS	
26	THURSDAY		
27	FRIDAY		
28	SATURDAY	HOLIDAY	
29	SUNDAY	HOLIDAY	
30	MONDAY		
31	TUESDAY		

JANUARY 2020

Date	Day	Particulars	No. of Working Days
1	WEDNESDAY	NEW YEAR - HOLIDAY	
2	THURSDAY		
3	FRIDAY		
4	SATURDAY		
5	SUNDAY	HOLIDAY	
6	MONDAY	Commencement of Theory Classes for 2 nd Sem B.E/M.E	1
7	TUESDAY		2
8	WEDNESDAY		3
9	THURSDAY		4
10	FRIDAY		5
11	SATURDAY	Compensation for 21.12.19	6
12	SUNDAY	HOLIDAY	
13	MONDAY		7
14	TUESDAY	Compensation for 23.12.19	8
15	WEDNESDAY	PONGAL - HOLIDAY	
16	THURSDAY	THIRUVALLUVAR DAY - HOLIDAY	
17	FRIDAY	UZHAVARTHIRUNAL - HOLIDAY	
18	SATURDAY	HOLIDAY	
19	SUNDAY	HOLIDAY	
20	MONDAY		9
21	TUESDAY		10
22	WEDNESDAY		11
23	THURSDAY		12
24	FRIDAY		13
25	SATURDAY	Compensation for 18.01.20	14
26	SUNDAY	REPUBLIC DAY - HOLIDAY	
27	MONDAY		15
28	TUESDAY		16
29	WEDNESDAY		17
30	THURSDAY		18
31	FRIDAY		19

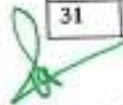

 PRINCIPAL,
 K. S. R. INSTITUTE FOR
 ENGINEERING AND TECHNOLOGY,
 K. S. R. RAJVI NAGAR,
 TIRUCHENGODE-637 215,
 NAMAKKAL DI. TAMIL NADU.

FEBRUARY 2020

Date	Day	Particulars	No. of Working Days
1	SATURDAY		20
2	SUNDAY	HOLIDAY	
3	MONDAY		21
4	TUESDAY		22
5	WEDNESDAY		23
6	THURSDAY		24
7	FRIDAY		25
8	SATURDAY	Compensation for 24.12.19	26
9	SUNDAY	HOLIDAY	
10	MONDAY	Internal Assessment- I S1	27
11	TUESDAY	S2	28
12	WEDNESDAY	S3	29
13	THURSDAY	S4	30
14	FRIDAY	S5	31
15	SATURDAY	S6	32
16	SUNDAY	HOLIDAY	
17	MONDAY		33
18	TUESDAY		34
19	WEDNESDAY		35
20	THURSDAY	Founder's Day	
21	FRIDAY		36
22	SATURDAY	Compensation for 26.12.19	37
23	SUNDAY	HOLIDAY	
24	MONDAY		38
25	TUESDAY		39
26	WEDNESDAY	Conference*	40
27	THURSDAY		41
28	FRIDAY		42
29	SATURDAY		43

MARCH 2020

Date	Day	Particulars	No. of Working Days
1	SUNDAY	HOLIDAY	
2	MONDAY		44
3	TUESDAY		45
4	WEDNESDAY		46
5	THURSDAY		47
6	FRIDAY		48
7	SATURDAY		49
8	SUNDAY	HOLIDAY	
9	MONDAY		50
10	TUESDAY		51
11	WEDNESDAY		52
12	THURSDAY		53
13	FRIDAY		54
14	SATURDAY	Compensation for 27.12.19	55
15	SUNDAY	HOLIDAY	
16	MONDAY		56
17	TUESDAY		57
18	WEDNESDAY		58
19	THURSDAY		59
20	FRIDAY	Internal assessment II S1	60
21	SATURDAY	S2	61
22	SUNDAY	HOLIDAY	
23	MONDAY	S3	62
24	TUESDAY	S4	63
25	WEDNESDAY	TELUGU NEW YEAR - HOLIDAY	
26	THURSDAY	S5	64
27	FRIDAY	S6	65
28	SATURDAY	Compensation for 30.12.19	66
29	SUNDAY	HOLIDAY	
30	MONDAY		67
31	TUESDAY		68

 PRINCIPAL,
 K. S. R. INSTITUTE FOR
 ENGINEERING AND TECHNOLOGY,
 K. S. R. KALVI NAGAR,
 TIRUCHENGODE-637 215,
 NAMAKKAL DL TAMIL NADU.

APRIL 2020

MAY 2020

Date	Day	Particulars	No. of Working Days
1	WEDNESDAY		69
2	THURSDAY		70
3	FRIDAY		71
4	SATURDAY		72
5	SUNDAY	HOLIDAY	
6	MONDAY	MAHAVEER JAYANTHI - HOLIDAY	
7	TUESDAY		73
8	WEDNESDAY		74
9	THURSDAY	Internal assessment III S1	75
10	FRIDAY	GOOD FRIDAY - HOLIDAY	
11	SATURDAY	Compensation for 31.12.19	76
12	SUNDAY	HOLIDAY	
13	MONDAY	S3	77
14	TUESDAY	TAMIL NEW YEAR - Dr. AMBEDKAR BIRTHDAY - HOLIDAY	
15	WEDNESDAY	S4	78
16	THURSDAY	S5	79
17	FRIDAY	S6	80
18	SATURDAY	Last Instruction Day*	81
19	SUNDAY	HOLIDAY	
20	MONDAY	University Practical Examinations*	
21	TUESDAY		
22	WEDNESDAY		
23	THURSDAY		
24	FRIDAY		
25	SATURDAY		
26	SUNDAY	HOLIDAY	
27	MONDAY		
28	TUESDAY		
29	WEDNESDAY		
30	THURSDAY		

Date	Day	Particulars	No. of Working Days
1	FRIDAY	MAY DAY - HOLIDAY	
2	SATURDAY	HOLIDAY	
3	SUNDAY	HOLIDAY	
4	MONDAY	University End Sem Examinations*	
5	TUESDAY		
6	WEDNESDAY		
7	THURSDAY		
8	FRIDAY		
9	SATURDAY	HOLIDAY	
10	SUNDAY	HOLIDAY	
11	MONDAY		
12	TUESDAY		
13	WEDNESDAY		
14	THURSDAY		
15	FRIDAY		
16	SATURDAY	HOLIDAY	
17	SUNDAY	HOLIDAY	
18	MONDAY		
19	TUESDAY		
20	WEDNESDAY		
21	THURSDAY		
22	FRIDAY		
23	SATURDAY	HOLIDAY	
24	SUNDAY	HOLIDAY	
25	MONDAY		
26	TUESDAY		
27	WEDNESDAY		
28	THURSDAY		
29	FRIDAY		
30	SATURDAY	HOLIDAY	
31	SUNDAY	HOLIDAY	

04.05.2020 – University End Semester Examinations*

 PRINCIPAL,
 K. S. R. INSTITUTE FOR
 ENGINEERING AND TECHNOLOGY,
 K. S. R. KALVI NAGAR,
 TIRUCHENGODE 637 215,
 NAMAKKAL Dt, TAMIL NADU.

ANNA UNIVERSITY:: CHENNAI 600 025

Internal Assessment Schedule for Non.Autonomous Affiliated Institutions

Period: July / November 2015

For all the UG Programmes except First Semester

Report No.	Report Period	Test Period	Report Entry Period
I	01.07.2015 – 29.07.2015	No Test	29.07.2015 – 08.08.2015 (Only Attendance)
II	30.07.2015 – 27.08.2015	21.08.2015 – 27.08.2015	27.08.2015 – 07.09.2015
III	28.08.2015 – 26.09.2015	18.09.2015 – 26.09.2015	26.09.2015 – 05.10.2015
IV	28.09.2015 – 27.10.2015	09.10.2015 – 15.10.2015	27.10.2015 – 31.10.2015

Saturdays may be included as working days to make good the shortages, if any.

*For all the PG Programmes except for the first semester and some of the PG programmes in the Faculty of Civil Engineering and Management Studies**

Report No.	Report Period	Test Period	Report Entry Period
I	13.07.2015 – 08.08.2015	No Test	08.08.2015 – 17.08.2015 (Only Attendance)
II	10.08.2015 – 05.09.2015	25.08.2015 – 05.09.2015	05.09.2015 – 14.09.2015
III	07.09.2015 – 01.10.2015	25.09.2015 – 01.10.2015	01.10.2015 – 10.10.2015
IV	02.10.2015 – 27.10.2015	09.10.2015 – 15.10.2015	27.10.2015 – 31.10.2015

Saturdays may be included as working days to make good the shortages, if any.

PRINCIPAL,
K. S. R. INSTITUTE FOR
ENGINEERING AND TECHNOLOGY
K. S. R. KALVI NAGAR,
TIRUCHENGODE-637 215,
NAMAKKAL DL, TAMIL NADU.

*** For M.E. Construction Engineering & Management / M.E. Soil Mechanics & Foundation
Engineering / M.E. Structural Engineering / M.Tech. Environmental Science & Engineering /
M.Tech. Remote Sensing programmes under the Faculty of Civil Engineering
and
M.B.A. Programm under the Faculty of Management Sciences**

In order to enable the students of the above mentioned programmes to undergo practical training / summer project during the first four weeks of the semester, the following internal Assessment Schedule need to be followed

Report No.	Report Period	Test Period	Report Entry Period
I	22.07.2015 – 17.08.2015	No Test	17.08.2015 – 26.08.2015 (Only Attendance)
II	18.08.2015 – 14.09.2015	07.09.2015 – 14.09.2015	14.09.2015 – 23.09.2015
III	15.09.2015 – 12.10.2015	28.09.2015 – 12.10.2015	12.10.2015 – 21.10.2015
IV	13.10.2015 – 06.11.2015	25.10.2015 – 31.10.2015	06.11.2015 – 09.11.2015

Saturdays may be included as working days to make good the shortages, if any.

15.7.15

CONTROLLER OF EXAMINATIONS

**PRINCIPAL,
K. S. R. INSTITUTE FOR
ENGINEERING AND TECHNOLOGY,
K. S. R. KALVI NAGAR,
TIRUCHENGODE-637 215,
NAMAKKAL DI, TAMIL NADU.**

ANNA UNIVERSITY:: CHENNAI 600 025

Internal Assessment Schedule for Non.Autonomous Affiliated Institutions

Period: July / November 2015

First Semester of all UG Programmes

Report No.	Report Period	Test Period	Report Entry Period
I	03-08-2015 – 29-08-2015	No Test	30-08-2015 – 07-09-2015
II	31-08-2015 – 29-09-2015	20-09-2015 – 29-09-2015	30-09-2015 – 07-10-2015
III	30-09-2015 – 31-10-2015	26-10-2015 – 31-10-2015	31-10-2015 – 07-11-2015
IV	02-11-2015 – 30-11-2015	23-11-2015 – 30-11-2015	30-11-2015 – 04-12-2015

Saturdays may be included as working days to make good the shortages, if any.

PRINCIPAL,
K. S. R. INSTITUTE FOR
ENGINEERING AND TECHNOLOGY,
K. S. R. KALVI NAGAR,
TIRUCHENGODE-637 215,
NORTH AVINASHI, MADU.

CONTROLLER OF EXAMINATIONS

ANNA UNIVERSITY :: CHENNAI – 600 025
Internal Assessment Schedule for Non-Autonomous Affiliated Institutions
Period : January – April 2016

B.E./B.Tech – 08th Semester & B.Arch – 10th Semester Only*

Report.No	Report Period	Test Period	Report Entry Period
1.	30-01-2016 --- 20-02-2016	No Test	20-02-2016 --- 27-02-2016
2.	22-02-2016 --- 09-03-2016	05-03-2016 --- 09-03-2016	09-03-2016 --- 17-03-2016
3.	10-03-2016 --- 31-03-2016	28-03-2016 --- 31-03-2016	31-03-2016 --- 07-04-2016
4.	01-04-2016 --- 18-04-2016	13-04-2016 --- 18-04-2016	18-04-2016 --- 20-04-2016

* All Saturdays are working days.

* Classes / Tests to be conducted on at least 4 Sundays.

CONTROLLER OF EXAMINATIONS 

PRINCIPAL
K. S. R. INSTITUTE FOR
ENGINEERING AND TECHNOLOGY,
K. S. R. KALVI NAGAR,
TIRUCHENGODE-637 215,
NAMAKKAL DL TAMIL NADU.

ANNA UNIVERSITY :: CHENNAI – 600 025
Internal Assessment Schedule for Non Autonomous Affiliated Institutions
Period : January – April 2016

UG & PG Degree Programmes other than (B.E./B.Tech - 08th Semester & B.Arch – 10th Semester)*

Report. No	Report Period	Test Period	Report Entry Period
1.	01-02-2016 -- 23-02-2016	No Test	10-03-2016 -- 16-03-2016
2.	24-02-2016 -- 17-03-2016	10-03-2016 -- 17-03-2016	17-03-2016 -- 26-03-2016
3.	18-03-2016 -- 12-04-2016	04-04-2016 -- 11-04-2016	12-04-2016 -- 23-04-2016
4.	13-04-2016 -- 07-05-2016	30-04-2016 -- 05-05-2016	07-05-2016 -- 12-05-2016

* All Saturdays are working days.

CONTROLLER OF EXAMINATIONS

PRINCIPAL,
K. S. R. INSTITUTE FOR
ENGINEERING AND TECHNOLOGY,
K. S. R. KALVI NAGAR,
TIRUCHENGODE-637 215,
NAMAKKAL Dt, TAMIL NADU.

ANNA UNIVERSITY:: CHENNAI 600 025
Internal Assessment Schedule for Non. Autonomous Affiliated Institutions
Period: July / December 2016

For all UG Programmes except First Semester

Report No.	Report Period	Test Period	Report Entry Period
I	04-07-2016 – 29-07-2016	No Test	29-07-2016 – 05-08-2016
II	01-08-2016 – 29-08-2016	16-08-2016 – 22-08-2016	29-08-2016 – 06-09-2016
III	30-08-2016 – 27-09-2016	19-09-2016 – 23-09-2016	27-09-2016 – 04-10-2016
IV	28-09-2016 – 26-10-2016	17-10-2016 – 21-10-2016	26-10-2016 – 28-10-2016

Saturdays may be included as working days to make good the shortages, if any.

For all UG-PART TIME Programmes First Semester

Report No.	Report Period	Test Period	Report Entry Period
I	11-07-2016 – 05-08-2016	No Test	05-08-2016 – 12-08-2016
II	08-08-2016 – 02-09-2016	26-08-2016 – 31-08-2016	02-09-2016 – 12-09-2016
III	06-09-2016 – 03-10-2016	23-09-2016 – 28-09-2016	03-10-2016 – 13-10-2016
IV	04-10-2016 – 01-11-2016	22-10-2016 – 27-10-2016	01-11-2016 – 03-11-2016

Saturdays may be included as working days to make good the shortages, if any.

 PRINCIPAL,
 K. S. R. INSTITUTE FOR
 ENGINEERING AND TECHNOLOGY,
 K. S. R. KALVI NAGAR,
 TIRUCHENGODE-637 215,
 NAMAKKAL DI, TAMIL NADU.

For all the PG Programmes except for the First Semester and some of the PG programmes in the Faculty of Civil Engineering and Management Studies*

Report No.	Report Period	Test Period	Report Entry Period
I	18-07-2016 – 11-08-2016	No Test	11-08-2016 – 19-08-2016
II	12-08-2016 – 09-09-2016	26-08-2016 – 07-09-2016	09-09-2016 – 16-09-2016
III	12-09-2016 – 06-10-2016	26-09-2016 – 04-10-2016	06-10-2016 – 18-10-2016
IV	07-10-2016 – 08-11-2016	27-10-2016 – 05-11-2016	08-11-2016 – 12-11-2016

Saturdays may be included as working days to make good the shortages, if any.

***For M.E. Construction Engineering & Management / M.E. Soil Mechanics & Foundation Engineering / M.E. Structural Engineering / M.Tech. Environmental Science & Engineering / M.Tech. Remote Sensing programmes under the Faculty of Civil Engineering and M.B.A. Programme under the Faculty of Management Sciences**

In order to enable the students of the above mentioned programmes to undergo practical training / summer project during the first week of the semester, the following internal Assessment Schedules need to be followed.

Report No.	Report Period	Test Period	Report Entry Period
I	25-07-2016 – 19-08-2016	No Test	22-08-2016 – 27-08-2016
II	22-08-2016 – 20-09-2016	07-09-2016 – 14-09-2016	20-09-2016 – 27-09-2016
III	21-09-2016 – 19-10-2016	28-09-2016 – 07-10-2016	19-10-2016 – 28-10-2016
IV	20-10-2016 – 15-11-2016	26-10-2016 – 07-11-2016	15-11-2016 – 18-11-2016

Saturdays may be included as working days to make good the shortages, if any.

CONTROLLER OF EXAMINATIONS jc

PRINCIPAL,
K. S. R. INSTITUTE FOR
ENGINEERING AND TECHNOLOGY,
K. S. R. KALVI NAGAR,
TIRUCHENGODE-637 215,
NAMAKKAL DI, TAMIL NADU,

ANNA UNIVERSITY :: CHENNAI 600 025

Internal Assessment Schedule for Non Autonomous Affiliated Institutions

Period : August / December 2016

For all UG Programmes First Semester

Report No.	Report Period	Test Period	Report Entry Period
I	01-08-2016 -- 29-08-2016	No Test	29-08-2016 -- 06-09-2016
II	30-08-2016 -- 27-09-2016	19-09-2016 -- 24-09-2016	27-09-2016 -- 04-10-2016
III	28-09-2016 -- 26-10-2016	17-10-2016 -- 22-10-2016	26-10-2016 -- 04-11-2016
IV	27-10-2016 -- 22-11-2016	10-11-2016 -- 16-11-2016	22-11-2016 -- 24-11-2016





Saturdays may be included as working days to make good the shortages, if any.

For all PG(FT / PT) Programmes First Semester

Report No.	Report Period	Test Period	Report Entry Period
I	22-08-2016 -- 20-09-2016	No Test	20-09-2016 -- 26-09-2016
II	21-09-2016 -- 20-10-2016	06-10-2016 -- 15-10-2016	20-10-2016 -- 27-10-2016
III	21-10-2016 -- 16-11-2016	07-11-2016 -- 12-11-2016	16-11-2016 -- 23-11-2016
IV	17-11-2016 -- 13-12-2016	01-12-2016 -- 07-12-2016	13-12-2016 -- 15-12-2016

Saturdays may be included as working days to make good the shortages, if any.

CONTROLLER OF EXAMINATIONS





PRINCIPAL,
K. S. R. INSTITUTE FOR
ENGINEERING AND TECHNOLOGY,
K. S. R. KALVI NAGAR,
TIRUCHENGODE-637 215,
NAMAKKAL DI, TAMIL NADU.

ANNA UNIVERSITY:: CHENNAI 600 025
Internal Assessment Schedule for Non. Autonomous Affiliated Institutions
Period: APR / MAY 2017

For all B.E. /B.Tech (Full-Time) eight Semester

Report No.	Report Period	Test Period	Report Entry Period
I	04-01-2017 – 30-01-2017	No Test	30-01-2017 – 07-02-2017
II	31-01-2017 – 22-02-2017	16-02-2017 – 21-02-2017	22-02-2017 – 01-03-2017
III	23-02-2017 – 17-03-2017	11-03-2017 – 16-03-2017	17-03-2017 – 25-03-2017
IV	18-03-2017 – 12-04-2017	05-04-2017 – 13-04-2017	13-04-2017 – 15-04-2017

Saturdays may be included as working days to make good the shortages, if any.

For all UG Programmes except eight Semester

Report No.	Report Period	Test Period	Report Entry Period
I	04-01-2017 – 02-02-2017	No Test	02-02-2017 – 09-02-2017
II	03-02-2017 – 28-02-2017	22-02-2017 – 27-02-2017	28-02-2017 – 08-03-2017
III	01-03-2017 – 25-03-2017	20-03-2017 – 24-03-2017	25-03-2017 – 04-04-2017
IV	27-03-2017 – 24-04-2017	18-04-2017 – 24-04-2017	24-04-2017 – 25-04-2017

Saturdays may be included as working days to make good the shortages, if any.



PRINCIPAL,
K. S. R. INSTITUTE FOR
ENGINEERING AND TECHNOLOGY,
K. S. R. KALVI NAGAR,
TIRUCHENGODE-637 215,
NAMAKKAL DISTRICT, TAMIL NADU.



For all the PG Programmes & Ph.D. Programmes*

Report No.	Report Period	Test Period	Report Entry Period
I	23-01-2017 – 15-02-2017	No Test	15-02-2017 – 22-02-2017
II	16-02-2017 – 10-03-2017	03-03-2017 – 08-03-2017	10-03-2017 – 17-03-2017
III	11-03-2017 – 04-04-2017	29-03-2017 – 03-04-2017	04-04-2017 – 12-04-2017
IV	05-04-2017 – 05-05-2017	25-04-2017 – 05-05-2017	05-05-2017 – 07-05-2017

Saturdays may be included as working days to make good the shortages, if any.

** Core Theory and Electives & Special Electives of Ph.D. Programmes.*

CONTROLLER OF EXAMINATIONS



PRINCIPAL,
K. S. R. INSTITUTE FOR
ENGINEERING AND TECHNOLOGY,
K. S. R. KALVI NAGAR,
TIRUCHENGODE-637 215,
NAMAKKAL DI, TAMIL NADU.

ANNA UNIVERSITY:: CHENNAI- 600 025
ACADEMIC AND ASSESSMENT SCHEDULE

July 2017 – December 2017 - ODD Semester
 ALL UG / PG (Full Time / Part Time) (Except 1st Semester)

S.No	Event	Date / Period
1.	Commencement of ODD Semester	03-07-2017
2.	Last date for Registration of Electives	14-07-2017
3.	Publication of End semester Time Table	20-07-2017
4.	Conduct of 1 st assessment test	17-08-2017 to 24-08-2017
5.	Last date for 1 st assessment Mark Entry	02-09-2017
6.	Conduct of 2 nd assessment test	15-09-2017 to 21-09-2017
7.	Last date for 2 nd assessment Mark Entry	30-09-2017
8.	Last day for Payment of Examination Fees	03-10-2017
9.	Conduct of 3 rd assessment test	13-10-2017 to 19-10-2017
10.	Last date for 3 rd assessment Mark Entry	20-10-2017
11.	Last working day	21-10-2017
12.	Issue of Hall Tickets	22-10-2017
13.	Conduct of Practical Examinations	23-10-2017 to 28-10-2017
14.	Conduct of End Semester Examinations	30-10-2017 to 30-11-2017
15.	Winter vacation	01-12-2017 to 17-12-2017
16.	Commencement of classes for Even semester	18-12-2017

Assessment Schedule for the Academic session of
July 2017 – December 2017 ODD Semester (Except 1st Semester)

Report. No	Report Period	Test Period	Web Portal Entry Period
1.	03-07-2017 – 27-07-2017	No Test	27-07-2017 – 05-08-2017
2.	28-07-2017 – 24-08-2017	17-08-2017 – 24-08-2017	24-08-2017 – 02-09-2017
3.	26-08-2017 – 21-09-2017	15-09-2017 – 21-09-2017	21-09-2017 – 30-09-2017
4.	22-09-2017 – 21-10-2017	13-10-2017 – 19-10-2017	18-10-2017 – 20-10-2017

 PRINCIPAL,
 K. S. R. INSTITUTE FOR
 ENGINEERING AND TECHNOLOGY,
 K. S. R. KALVI NAGAR,
 TIRUCHENGODE-637 215,
 NAMAKKAL DI. TAMIL NADU.

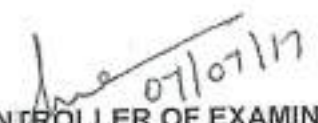
 CONTROLLER OF EXAMINATIONS

ANNA UNIVERSITY:: CHENNAI 600 025
Internal Assessment Schedule for Non. Autonomous Affiliated Institutions
Period: November / December 2017

For all UG Programmes (First Semester)

Report No.	Report Period	Test Period	Report Entry Period
I	01-09-2017 – 28-09-2017	No Test	03-10-2017 – 10-10-2017
II	03-10-2017 – 30-10-2017	21-10-2017 – 30-10-2017	30-10-2017 – 07-11-2017
III	31-10-2017 – 25-11-2017	17-11-2017 – 22-11-2017	25-11-2017 – 05-12-2017
IV	27-11-2017 – 20-12-2017	11-12-2017 – 18-12-2017	20-12-2017 – 23-12-2017

Saturdays may be included as working days to make good the shortages, if any.

For all PG Programmes (First Semester)

Report No.	Report Period	Test Period	Report Entry Period
I	06-09-2017 – 06-10-2017	No Test	06-10-2017 – 14-10-2017
II	07-10-2017 – 03-11-2017	21-10-2017 – 28-10-2017	03-11-2017 – 10-11-2017
III	04-11-2017 – 30-11-2017	20-11-2017 – 30-11-2017	30-11-2017 – 08-12-2017
IV	02-12-2017 – 26-12-2017	13-12-2017 – 20-12-2017	27-12-2017 – 30-12-2017

Saturdays may be included as working days to make good the shortages, if any.

CONTROLLER OF EXAMINATIONS



PRINCIPAL,
K. S. R. INSTITUTE FOR
ENGINEERING AND TECHNOLOGY,
K. S. R. KALVI NAGAR,
TIRUCHENGODE-637 215,
NAMAKKAL DL, TAMIL NADU.

ANNA UNIVERSITY:: CHENNAI 600 025
Internal Assessment Schedule for Non. Autonomous Affiliated Institutions
Period: November / December 2017

REVISED

For all UG Programmes (First Semester)

Report No.	Report Period	Test Period	Report Entry Period
I	01-09-2017 – 28-09-2017	No Test	03-10-2017 – 10-10-2017
II	03-10-2017 – 30-10-2017	21-10-2017 – 30-10-2017	30-10-2017 – 07-11-2017
III	31-10-2017 – 21-11-2017	17-11-2017 – 21-11-2017	21-11-2017 – 28-11-2017
IV	22-11-2017 – 11-12-2017	08-12-2017 – 11-12-2017	11-12-2017 – 14-12-2017

Saturdays may be included as working days to make good the shortages, if any.

For all PG Programmes (First Semester)

Report No.	Report Period	Test Period	Report Entry Period
I	06-09-2017 – 06-10-2017	No Test	06-10-2017 – 14-10-2017
II	07-10-2017 – 03-11-2017	21-10-2017 – 28-10-2017	03-11-2017 – 10-11-2017
III	04-11-2017 – 27-11-2017	17-11-2017 – 27-11-2017	27-11-2017 – 05-12-2017
IV	28-11-2017 – 18-12-2017	13-12-2017 – 18-12-2017	18-12-2017 – 21-12-2017

Saturdays may be included as working days to make good the shortages, if any.

6/11/17
CONTROLLER OF EXAMINATIONS

PRINCIPAL,
K. S. R. INSTITUTE FOR
ENGINEERING AND TECHNOLOGY,
K. S. R. KALVI NAGAR,
TIRUCHENGODE-637 215,
NAMAKKAL DI, TAMIL NADU.

ANNA UNIVERSITY:: CHENNAI- 600 025
ACADEMIC AND ASSESSMENT SCHEDULE

December 2017 – June 2018 - Even Semester
ALL UG / PG (Full Time / Part Time)

S.No	Event	Date / Period
1.	Commencement of Even Semester	18-12-2017
2.	Last date for Registration of Electives	03-01-2018
3.	Publication of End semester Exam Time Table	22.01.2018
4.	Conduct of 1 st assessment test	05-02-2018 – 10-02-2018
5.	Last date for 1 st assessment Mark Entry	20-02-2018
6.	Conduct of 2 nd assessment test	02-03-2018 – 08-03-2018
7.	Last date for 2 nd assessment Mark Entry	19-03-2018
8.	Last day for Payment of Examination Fees	15-03-2018
9.	Conduct of 3 rd assessment test	28-03-2018 – 05-04-2018
10.	Last date for 3 rd assessment Mark Entry	12-04-2018
11.	Last working day	10-04-2018
12.	Issue of Hall Tickets	11-04-2018
13.	Conduct of Practical Examinations	12-04-2018
14.	Conduct of End Semester Examinations	23-04-2018
15.	Summer vacation	From End of Exam date up to 01-07-2018.
16.	Commencement of classes for ODD semester	02-07-2018(Tentative)

Assessment Schedule for the Academic session of
December 2017 – June 2018 - Even Semester

Report. No	Report Period	Test Period	Web Portal Entry Period
1.	18-12-2017 – 12-01-2018	No Test	17-01-2018 – 24-01-2018
2.	17-01-2018 – 13-02-2018	05-02-2018 – 10-02-2018	13-02-2018 – 20-02-2018
3.	14-02-2018 – 12-03-2018	02-03-2018 – 08-03-2018	12-03-2018 – 19-03-2018
4.	13-03-2018 – 10-04-2018	28-03-2018 – 05-04-2018	10-04-2018 – 12-04-2018

 PRINCIPAL
 K. S. R. INSTITUTE FOR
 ENGINEERING AND TECHNOLOGY
 K. S. R. KALVINAGAR,
 TIRUCHENGODE-637 215,
 NAMAKKAL DISTRICT, TAMIL NADU.

 CONTROLLER OF EXAMINATIONS

ANNA UNIVERSITY:: CHENNAI- 600 025
ACADEMIC AND ASSESSMENT SCHEDULE

January 2018 – May 2018 – Second Semester

(Regulations – 2017 only)

ALL UG / PG (Full Time / Part Time)

S.No	Event	Date / Period
1.	Commencement of Second Semester	22-01-2018
2.	Last date for Registration of Electives	10-02-2018
3.	Publication of End semester Exam Time Table	29.01.2018
4.	Conduct of 1 st assessment test	06-03-2018 – 14-03-2018
5.	Last date for 1 st assessment Mark Entry	22-03-2018
6.	Conduct of 2 nd assessment test	04-04-2018 – 10-04-2018
7.	Last date for 2 nd assessment Mark Entry	19-04-2018
8.	Last day for Payment of Examination Fees	14-04-2018
9.	Conduct of 3 rd assessment test	25-04-2018 – 03-05-2018
10.	Last date for 3 rd assessment Mark Entry	07-05-2018
11.	Last working day	05-05-2018
12.	Hall Ticket Generation	03-05-2018 to 06-05-2018
13.	Commencement of Practical Examinations	07-05-2018
14.	Commencement of End Semester Examinations	16-05-2018
15.	Summer vacation	From 30.05.2018 to 01-07-2018
16.	Commencement of classes for next semester	02-07-2018

January 2018 – May 2018 – Second Semester

(Regulations – 2017 only)

ALL UG / PG (Full Time / Part Time)

Report. No	Report Period	Test Period	Web Portal Entry Period
1.	22-01-2018 – 16-02-2018	No Test	17-02-2018 – 24-02-2018
2.	17-02-2018 – 14-03-2018	06-03-2018 – 14-03-2018	14-03-2018 – 22-03-2018
3.	15-03-2018 – 10-04-2018	04-04-2018 – 10-04-2018	10-04-2018 – 19-04-2018
4.	11-04-2018 – 03-05-2018	25-04-2018 – 03-05-2018	03-05-2018 – 07-05-2018

 PRINCIPAL
 K. S. R. INSTITUTE FOR
 ENGINEERING AND TECHNOLOGY
 K. S. R. KALVI NAGAR,
 TIRUCHENGODE-637 215,
 NAMAKKAL DISTRICT, TAMIL NADU.
 ---Sd---
 Controller of Examinations

ANNA UNIVERSITY :: CHENNAI 600 025

Internal Assessment Schedule for Non Autonomous Affiliated Institutions

Period : November / December 2018

For all UG/PG - Programmes Except First Semester (Full Time)

Report No	Report Period	Test Period	Report Entry Period
I	02-07-2018 – 27-07-2018	No Test	02-08-2018 -- 09-08-2018
II	28-07-2018 – 25-08-2018	17-08-2018 -- 25-08-2018	25-08-2018 -- 31-08-2018
III	27-08-2018 – 20-09-2018	14-09-2018 -- 20-09-2018	20-09-2018 -- 27-09-2018
IV	22-09-2018 -- 17-10-2018	10-10-2018 -- 17-10-2018	17-10-2018 -- 20-10-2018

Saturdays may be included as working days to make good the Shortages, if any.

CONTROLLER OF EXAMINATIONS

PRINCIPAL
K. S. R. INSTITUTE FOR
ENGINEERING AND TECHNOLOGY
K. S. R. KALVI NAGAR
TIRUCHENGODE-607 215
NARAKKAL DI, TAMIL NADU

ANNA UNIVERSITY:: CHENNAI – 600 025
 Internal Assessment Schedule for Non Autonomous Affiliated Institutions
Period : November / December 2018 Examinations

ALL UG (Full Time) & M.B.A/M.C.A – First Semester

Report No.	Report Period	Test Period	Report Entry Period
I	03-09-2018 – 20-09-2018	No Test	28-09-2018 – 04-10-2018
II	22-09-2018 – 16-10-2018	10-10-2018 – 16-10-2018	16-10-2018 – 20-10-2018
III	17-10-2018 – 12-11-2018	05-11-2018 – 12-11-2018	12-11-2018 – 15-11-2018
IV	13-11-2018 – 10-12-2018	04-12-2018 – 10-12-2018	10-12-2018 – 12-12-2018

M.E. / M.Tech. / M.Arch (Full Time) – First Semester

Report No.	Report Period	Test Period	Report Entry Period
I	10-09-2018 – 28-09-2018	No Test	28-09-2018 – 04-10-2018
II	29-09-2018 – 25-10-2018	17-10-2018 – 25-10-2018	25-10-2018 – 30-10-2018
III	26-10-2018 – 19-11-2018	13-11-2018 – 19-11-2018	19-11-2018 – 24-11-2018
IV	20-11-2018 – 15-12-2018	10-12-2018 – 15-12-2018	15-12-2018 – 17-12-2018

 CONTROLLER OF EXAMINATIONS

 PRINCIPAL,
 K. S. R. INSTITUTE FOR
 ENGINEERING AND TECHNOLOGY,
 K. S. R. KALVI NAGAR,
 TIRUCHENGODE-637 215,
 NAMAKKAL DL, TAMIL NADU

ANNA UNIVERSITY :: CHENNAI 600 025

Internal Assessment Schedule for Non Autonomous Affiliated Institutions

Period : April/ May 2019 Examinations

For all UG/PG - Programmes Except II Semester (Full Time/Part Time)

Report No	Report Period	Test Period	Report Entry Period
I	19-12-2018 -- 11-01-2019	No Test	18-01-2019 -- 23-01-2019
II	12-01-2019 -- 07-02-2019	01-02-2019 -- 07-02-2019	07-02-2019 -- 12-02-2019
III	08-02-2019 -- 01-03-2019	23-02-2019 -- 01-03-2019	01-03-2019 -- 06-03-2019
IV	02-03-2019 -- 22-03-2019	18-03-2019 -- 22-03-2019	22-03-2019 -- 23-03-2019

For all UG/PG - Programmes II Semester (Full Time)

Report No	Report Period	Test Period	Report Entry Period
I	21-01-2019 -- 12-02-2019	No Test	12-02-2019 -- 16-02-2019
II	13-02-2019 -- 06-03-2019	28-02-2019 -- 06-03-2019	06-03-2019 -- 11-03-2019
III	07-03-2019 -- 28-03-2019	22-03-2019 -- 28-03-2019	28-03-2019 -- 02-04-2019
IV	29-03-2019 -- 22-04-2019	13-04-2019 -- 22-04-2019	22-04-2019 -- 23-04-2019

Saturdays may be included as working days to make good the Shortages, if any.

PRINCIPAL
K. S. R. INSTITUTE FOR
ENGINEERING AND TECHNOLOGY,
K. S. R. KALVI NAGAR,
TIRUCHENGODE-637 215,
NAMAKKAL DISTRICT, TAMIL NADU.

CONTROLLER OF EXAMINATIONS

ANNA UNIVERSITY :: CHENNAI 600 025

Internal Assessment Schedule for Non Autonomous Affiliated Institutions

Period : April/ May 2019 Examinations

For all UG - Programmes II Semester (Part Time)

Report No	Report Period	Test Period	Report Entry Period
I	19-12-2018 -- 11-01-2019	No Test	18-01-2019 -- 23-01-2019
II	12-01-2019 -- 07-02-2019	01-02-2019 -- 07-02-2019	07-02-2019 -- 12-02-2019
III	08-02-2019 -- 01-03-2019	23-02-2019 -- 01-03-2019	01-03-2019 -- 06-03-2019
IV	02-03-2019 -- 22-03-2019	18-03-2019 -- 22-03-2019	22-03-2019 -- 23-03-2019

Saturdays may be included as working days to make good the Shortages, if any.

By. [Signature]
CONTROLLER OF EXAMINATIONS

PRINCIPAL
K. S. R INSTITUTE FOR
ENGINEERING AND TECHNOLOGY,
K. S. R. KALVI NAGAR,
TIRUCHENGODE-637 215,
NAMAKKAL DL, TAMIL NADU.

ANNA UNIVERSITY :: CHENNAI 600 025

Internal Assessment Schedule for Non Autonomous Affiliated Institutions

Period : Nov./ Dec. 2019 Examinations

For all UG/PG - Programmes Except I year (Full Time)

Report No	Report Period	Test Period	Report Entry Period
I	01-07-2019 -- 25-07-2019	No Test	25-07-2019 -- 30-07-2019
II	26-07-2019 -- 22-08-2019	16-08-2019 -- 22-08-2019	22-08-2019 -- 28-08-2019
III	24-08-2019 -- 20-09-2019	14-09-2019 -- 20-09-2019	20-09-2019 -- 25-09-2019
IV	21-09-2019 -- 19-10-2019	14-10-2019 -- 19-10-2019	19-10-2019 -- 21-10-2019

Saturdays may be included as working days to make good the Shortages, if any.

10.7.19
CONTROLLER OF EXAMINATIONS

**PRINCIPAL,
K. S. R. INSTITUTE FOR
ENGINEERING AND TECHNOLOGY,
K. S. R. KALVI NAGAR,
TIRUGHENGODE-637 215,
NAMAKKAL DI, TAMIL NADU.**

ANNA UNIVERSITY :: CHENNAI 600 025

Internal Assessment Schedule for Non Autonomous Affiliated Institutions

Period : Nov./ Dec. 2019 Examinations

B.E./B.Tech. UG - Programmes 1 semester (Full Time)

Report No	Report Period	Test Period	Report Entry Period
I	14-08-2019 -- 09-09-2019	No Test	09-09-2019 -- 14-09-2019
II	11-09-2019 -- 04-10-2019	27-09-2019 -- 04-10-2019	04-10-2019 -- 11-10-2019
III	05-10-2019 -- 29-10-2019	23-10-2019 -- 29-10-2019	29-10-2019 -- 02-11-2019
IV	30-10-2019 -- 20-11-2019	14-11-2019 -- 20-11-2019	20-11-2019 -- 21-11-2019

Saturdays may be included as working days to make good the Shortages, if any.

CONTROLLER OF EXAMINATIONS

PRINCIPAL,
K. S. R. INSTITUTE FOR
ENGINEERING AND TECHNOLOGY,
K. S. R. KALVI NAGAR,
TIRUCHENGODE-637 215,
NAMAKKAL DL, TAMIL NADU.

ANNA UNIVERSITY :: CHENNAI 600 025

Internal Assessment Schedule for Non Autonomous Affiliated Institutions

Period : April/ May 2020 Examinations

For all UG/PG - Programmes Except II Semester (Full Time/Part Time)

Report No	Report Period	Test Period	Report Entry Period
I	16-12-2019 -- 11-01-2020	No Test	11-01-2020 -- 24-01-2020
II	13-01-2020 -- 08-02-2020	04-02-2020 -- 08-02-2020	08-02-2020 -- 13-02-2020
III	10-02-2020 -- 03-03-2020	27-02-2020 -- 03-03-2020	03-03-2020 -- 07-03-2020
IV	04-03-2020 -- 27-03-2020	21-03-2020 -- 27-03-2020	27-03-2020 -- 29-03-2020

UG - Programmes II Semester (B.E./B.Tech - Full Time/Part Time & B.Arch)

Report No	Report Period	Test Period	Report Entry Period
I	20-01-2020 -- 05-02-2020	No Test	05-02-2020 -- 10-02-2020
II	06-02-2020 -- 29-02-2020	25-02-2020 -- 29-02-2020	29-02-2020 -- 05-03-2020
III	02-03-2020 -- 26-03-2020	21-03-2020 -- 26-03-2020	26-03-2020 -- 31-03-2020
IV	27-03-2020 -- 24-04-2020	20-04-2020 -- 24-04-2020	24-04-2019 -- 26-04-2020

Saturdays may be included as working days to make good the Shortages, if any.



[Signature]
12.11.2020
CONTROLLER OF EXAMINATIONS

PRINCIPAL,
K. S. R. INSTITUTE FOR
ENGINEERING AND TECHNOLOGY,
K. S. R. KALVINAGAR,
TIRUCHENGOORE-637 215,
NAMAKKAL DL, TAMIL NADU.

ANNA UNIVERSITY :: CHENNAI 600 025

Internal Assessment Schedule for Non Autonomous Affiliated Institutions

Period : April/ May 2020 Examinations

PG - Programmes II semester (Full Time)

Report No	Report Period	Test Period	Report Entry Period
I	29-01-2020 -- 14-02-2020	No Test	14-02-2020 -- 19-02-2020
II	15-02-2020 -- 09-03-2020	04-03-2020 -- 09-03-2020	09-03-2020 -- 13-03-2020
III	10-03-2020 -- 02-04-2020	28-03-2020 -- 02-04-2020	02-04-2020 -- 08-04-2020
IV	03-04-2020 -- 29-04-2020	24-04-2020 -- 29-04-2020	29-04-2020 -- 30-04-2020

Saturdays may be included as working days to make good the Shortages, if any.

17.  13/2/2020
CONTROLLER OF EXAMINATIONS

PRINCIPAL
K. S. R. INSTITUTE FOR
ENGINEERING AND TECHNOLOGY,
K. S. R. KALVI NAGAR,
TIRUCHENGODE-637 215,
NAMAKKAL Dt, TAMIL NADU.

ANNA UNIVERSITY :: CHENNAI 600 025

Internal Assessment Schedule for Non Autonomous Affiliated Institutions

August - November 2020 (For all UG/PG - Programmes Except I Semester (Full Time/Part Time))

Report No	Report Period	Test Period	Report Entry Period
I	-----	----	-----
II	12-08-2020 -- 07-09-2020	01-09-2020 -- 05-09-2020	07-09-2020 -- 11-09-2020
III	08-09-2020 -- 30-09-2020	23-09-2020 -- 29-09-2020	30-09-2020 -- 06-10-2020
IV	01-10-2020 -- 26-10-2020	19-10-2020 -- 24-10-2020	26-10-2020 -- 28-10-2020

Saturdays may be included as working days to make good the Shortages, if any.

CONTROLLER OF EXAMINATIONS

PRINCIPAL,
K. S. R. INSTITUTE FOR
ENGINEERING AND TECHNOLOGY,
K. S. R. KALVI NAGAR,
TIRUCHENGODE-637 215,
NAMAKKAL Dt, TAMIL NADU.

ANNA UNIVERSITY :: CHENNAI 600 025
Internal Assessment Schedule for Non Autonomous Affiliated Institutions
Period : November 2020 / March 2021 (ODD SEMESTER – I SEMESTER) – UG PROGRAMMES

B.E. / B.Tech (Full Time)

Report No	Report Period	Test Period	Report Entry Period
I	23-11-2020 – 08-12-2020	No Test	08-12-2020 – 15-12-2020
II	09-12-2020 – 03-01-2021	26-12-2020 – 03-01-2021	03-01-2021 – 11-01-2021
III	04-01-2021 – 01-02-2021	20-01-2021 – 01-02-2021	01-02-2021 – 08-02-2021
IV	02-02-2021 – 24-02-2021	20-02-2021 – 24-02-2021	24-02-2021 – 26-02-2021

B.E./B.Tech - Part Time & B.Arch (Full Time)

Report No	Report Period	Test Period	Report Entry Period
I	30-11-2020 – 15-12-2020	No Test	15-12-2020 – 23-12-2020
II	16-12-2020 – 09-01-2021	05-01-2021 – 09-01-2021	09-01-2021 – 20-01-2021
III	11-01-2021 – 08-02-2021	02-02-2021 – 08-02-2021	08-02-2021 – 15-02-2021
IV	09-02-2021 – 03-03-2021	25-02-2021 – 03-03-2021	03-03-2021 – 05-03-2021

Saturdays may be included as working days to make good the shortages, if any.



(Signature)
CONTROLLER OF EXAMINATIONS

(Signature)
PRINCIPAL,
ENGINEERING AND TECHNOLOGY,
K. S. R. KALVI NAGAR,
TIRUCHENGODE-637 215,
NAMAKKAL Dt, TAMIL NADU.

ANNA UNIVERSITY :: CHENNAI 600 025

Internal Assessment Schedule for Non Autonomous Affiliated Institutions

Period : December 2020 / April 2021 (ODD SEMESTER – I SEMESTER) – PG PROGRAMMES

M.B.A / M.C.A (Full Time) & M.B.A (5 Yrs - Integrated)

Report No	Report Period	Test Period	Report Entry Period
I	09-12-2020 -- 26-12-2020	No Test	26-12-2020 -- 04-01-2021
II	28-12-2020 -- 23-01-2021	18-01-2021 -- 23-01-2021	23-01-2021 -- 30-01-2021
III	25-01-2021 -- 18-02-2021	12-02-2021 -- 18-02-2021	18-02-2021 -- 25-02-2021
IV	19-02-2021 -- 13-03-2021	08-03-2021 -- 13-03-2021	13-03-2021 -- 15-03-2021

M.E. / M.Tech. / M.Arch (Full Time)

Report No	Report Period	Test Period	Report Entry Period
I	30-12-2020 -- 20-01-2021	No Test	20-01-2021 -- 25-01-2021
II	21-01-2021 -- 15-02-2021	09-02-2021 -- 15-02-2021	15-02-2021 -- 22-02-2021
III	16-02-2021 -- 10-03-2021	04-03-2021 -- 10-03-2021	10-03-2021 -- 15-03-2021
IV	11-03-2021 -- 03-04-2021	27-03-2021 -- 03-04-2021	03-04-2021 -- 05-04-2021

Saturdays may be included as working days to make good the Shortages, if any.



[Handwritten signature]

[Handwritten signature]
CONTROLLER OF EXAMINATIONS

[Green checkmark]
PRINCIPAL,
K. S. R. INSTITUTE FOR
ENGINEERING AND TECHNOLOGY,
K. S. R. KALVI NAGAR,
TIRUCHENGODE-637 215,
NAMAKKAL DI, TAMIL NADU.

ANNA UNIVERSITY :: CHENNAI 600 025

Internal Assessment Schedule for Non Autonomous Affiliated Institutions

Period : December 2020 – May 2021 (Even Semester – Final Semester) Examinations

For all UG/PG Programmes

Report No	Report Period	Test Period	Report Entry Period
I	14-12-2020 -- 07-01-2021	No Test	20-02-2021 -- 25-02-2021
II	08-01-2021 -- 30-01-2021	25-01-2021 -- 30-01-2021	26-02-2021 -- 05-03-2021
III	18-02-2021 -- 16-03-2021	10-03-2021 -- 16-03-2021	16-03-2021 -- 22-03-2021
IV	17-03-2021 -- 12-04-2021	05-04-2021 -- 12-04-2021	12-04-2021 -- 15-04-2021

Period : February 2021 – June 2021 (Even Semester – Except II & Final Semester) Examinations

For all UG/PG Programmes

Report No	Report Period	Test Period	Report Entry Period
I	18-02-2021 -- 06-03-2021	No Test	06-03-2021 -- 11-03-2021
II	08-03-2021 -- 30-03-2021	25-03-2021 -- 30-03-2021	30-03-2021 -- 08-04-2021
III	31-03-2021 -- 26-04-2021	20-04-2021 -- 26-04-2021	26-04-2021 -- 31-04-2021
IV	27-04-2020 -- 21-05-2021	17-05-2021 -- 21-05-2021	21-05-2021 -- 24-05-2021

Saturdays may be included as working days to make good the Shortages, if any.

CONTROLLER OF EXAMINATIONS

19/02/2021

PRINCIPAL
K. S. R. INSTITUTE FOR
ENGINEERING AND TECHNOLOGY,
K. S. R. KALVI NAGAR,
TIRUCHENGODE-637 215,
NAMAKKAL DL, TAMIL NADU.

ANNA UNIVERSITY :: CHENNAI 600 025

Internal Assessment Schedule for Non Autonomous Affiliated Institutions

Period : April 2021- July 2021 (EVENT SEMESTER -II Semester)

UG (FT/PT) Degree Programmes

Report No	Report Period	Test Period	Report Entry Period
I	08-04-2021 – 27-04-2021	No Test	05-05-2021 – 10-05-2021
II	28-04-2021 – 22-05-2021	18-05-2021 – 22-05-2021	22-05-2021 – 27-05-2021
III	24-05-2021 – 15-06-2021	10-06-2021 – 15-06-2021	15-06-2021 – 19-06-2021
IV	16-06-2021 – 08-07-2021	03-07-2021 – 08-07-2021	08-07-2021 – 09-07-2021

PG (FT) Degree Programmes (EXCEPT MCA)

Report No	Report Period	Test Period	Report Entry Period
I	03-05-2021 – 20-05-2021	No Test	20-05-2021 – 25-05-2021
II	21-05-2021 – 15-06-2021	10-06-2021 – 15-06-2021	15-06-2021 – 19-06-2021
III	16-06-2021 – 10-07-2021	06-07-2021 – 10-07-2021	10-07-2021 – 15-07-2021
IV	12-07-2021 – 06-08-2021	02-08-2021 – 06-08-2021	06-08-2021 – 08-08-2021

Saturdays may be included as working days to make good the Shortages, if any.

04/05/21
CONTROLLER OF EXAMINATIONS

PRINCIPAL,
K. S. R. INSTITUTE FOR
ENGINEERING AND TECHNOLOGY,
K. S. R. KALVI NAGAR,
TIRUCHENGODE-637 215,
NAMAKKAL DI, TAMIL NADU.

EXAMINATION CONTROL OFFICE

EXAM CIRCULAR

It is to inform all HoDs, Faculty Members and UG II, III & IV year students that the Internal Assessment Test - I commences on 17.08.2018 (Friday).

Timing: 11.00am -12.40pm

Circulated to all departments

The Test Schedule is given below:

II - YEAR

DATE	DAY	CSE	EEE	ECE - A	ECE - B	MECH A&B	IT
17.08.2018	Friday	CE	TPDE	FDSC	DE	TPDE	DM
18.08.2018	Saturday	DS	DLC	SS	SS	ETD	DPSD
20.08.2018	Monday	DM	EMT	DE	FDSC	FMM	DS
21.08.2018	Tuesday	DPSD	EM-I	CSE	CSE	MT-I	OOP
23.08.2018	Thursday	-	EDC	EC-I	EC-I	EDC	ADC
24.08.2018	Friday	OOPS	PPE	LAPDE	LAPDE	-	-

III - YEAR

DATE	DAY	CSE	EEE	ECE - A	ECE - B	MECH A & B	IT
17.08.2018	Friday	IP	MPMC	DC	DC	CAD	CN
18.08.2018	Saturday	OOAD	PSA	PDSP	PDSP	HMT	GM
20.08.2018	Monday	TOC	PE	MPMC	ESE	DME	OOAD
21.08.2018	Tuesday	CG	PE	TLWG	TLWG	MM	DSP
23.08.2018	Thursday	-	EM-II	ESE	MPMC	DOM	WP
24.08.2018	Friday	DM	CS	-	-	PEE	WC

IV - YEAR

DATE	DAY	CSE	EEE A&B	ECE-A	ECE-B	MECH A&B&C	IT
17.08.2018	Friday	CNS	HVE	RFMW	ACA	PPE	IM
18.08.2018	Saturday	IR	PSG	OCN	OCN	MECH	CNS
20.08.2018	Monday	GCC	PSEM	ERTTS	ERTS	CIM	DWDM
21.08.2018	Tuesday	GTA	POM	DIP	DIP	TQM	GCC
23.08.2018	Thursday	SOA	FOLI	ACA	RFMW	PPCE	ASN
24.08.2018	Friday	RMT	MBSD	OED	OED	ROB	-

Exam Head

Principal

PRINCIPAL,
K. S. R. INSTITUTE FOR
ENGINEERING AND TECHNOLOGY,
K. S. R. KALVI NAGAR,
TIRUCHENGODE-637 215,
NAMAKKAL Dt. TAMIL NADU.

K S R INSTITUTE FOR ENGINEERING AND TECHNOLOGY
TIRUCHENGODE - 637 215

DATE: 06.08.2018

EXAMINATION CONTROL OFFICE

EXAM CIRCULAR

It is to inform all HoDs, Faculty Members and PG II year students that the Internal Assessment Test – I commences on 17.08.2018 (Friday).

Timing: 11.00am -12.40pm

Circulated to all departments

The Test Schedule is given below:

II - YEAR

DATE	DAY	CAD/CAM	CSE	EST	SE
17.08.2018	Friday	PLM	SQAT	SCOT	WDM
18.08.2018	Saturday	MNDT	SNA	WMC	UIDE
20.08.2018	Monday	QMT	MAD	CNS	SOAD

Exam Head

Principal

PRINCIPAL
K. S. R. INSTITUTE FOR
ENGINEERING AND TECHNOLOGY
K. S. R. KALVI NAGAR,
TIRUCHENGODE-637 215,
NAMAKKAL DL, TAMIL NADU.

K S R INSTITUTE FOR ENGINEERING AND TECHNOLOGY
TIRUCHENGODE - 637 215

DATE: 04.09.2018

EXAMINATION CONTROL OFFICE

EXAM CIRCULAR

It is to inform all HoDs, Faculty Members and UG II, III & IV year students that the Internal Assessment Test - II commences on 14.09.2018 (Friday).

Timing: 11.00am -12.40pm

Circulated to all departments

The Test Schedule is given below:

II - YEAR

DATE	DAY	CSE	EEE	ECE - A	ECE - B	MECH A&B	IT
14.09.2018	Friday	CE	TPDE	DE	DE	TPDE	DM
15.09.2018	Saturday	DS	DLC	SS	FDSC	ETD	DPSD
17.09.2018	Monday	DM	EMT	CSE	CSE	FMM	DS
18.09.2018	Tuesday	OOPS	EM-I	EC-I	EC-I	MT-I	OOP
19.09.2018	Wednesday	DPSD	EDC	FDSC	SS	EDC	ADC
20.09.2018	Thursday	-	PPE	LAPDE	LAPDE	-	-

III - YEAR

DATE	DAY	CSE	EEE	ECE - A	ECE - B	MECH A & B	IT
14.09.2018	Friday	IP	MPMC	ESE	MPMC	CAD	CN
15.09.2018	Saturday	OOAD	PSA	PDSP	PDSP	HMT	GM
17.09.2018	Monday	TOC	PPE	MPMC	ESE	DME	OOAD
18.09.2018	Tuesday	CG	PE	TLWG	TLWG	MM	DSP
19.09.2018	Wednesday	DM	EM-II	DC	DC	DOM	WP
20.09.2018	Thursday	-	CS	-	-	PEE	WC

IV - YEAR

DATE	DAY	CSE	EEE A	EEE B	ECE - A	ECE - B	MECH A&B&C	IT
14.09.2018	Friday	RMT	HVE	HVE	RFMW	ACA	PPE	IM
15.09.2018	Saturday	CNS	PSG	PSG	OCN	OCN	MECH	CNS
17.09.2018	Monday	IR	PSEM	PSEM	ERTS	ERTS	CIM	DWDM
18.09.2018	Tuesday	GTA	POM	POM	DIP	DIP	TQM	GCC
19.09.2018	Wednesday	GCC	FOLI	MBSD	ACA	RFMW	PPCE	ASN
20.09.2018	Thursday	SOA	MBSD	FOLI	OED	OED	ROB	

Exam Head

PRINCIPAL,
K. S. R. INSTITUTE FOR
ENGINEERING AND TECHNOLOGY,
K. S. R. KALVI NAGAR,
TIRUCHENGODE-637 215,
NAMAKKAL DI. TAMIL NADU.

Principal

K S R INSTITUTE FOR ENGINEERING AND TECHNOLOGY
TIRUCHENGODE - 637 215

DATE: 04.09.2018

EXAMINATION CONTROL OFFICE

EXAM CIRCULAR

It is to inform all HoDs, Faculty Members and PG II year students that the Internal Assessment Test - II commences on 14.09.2018 (Friday).

Timing: 11.00am -12.40pm

Circulated to all departments

The Test Schedule is given below:

II - YEAR

DATE	DAY	CAD/CAM	CSE	EST	SE
14.09.2018	Friday	PLM	SQAT	SCOT	WDM
15.09.2018	Saturday	MNDT	SNA	WMC	UIDE
17.09.2018	Monday	QMT	MAD	CNS	SOAD

Exam Head

Principal

PRINCIPAL
K. S. R. INSTITUTE FOR
ENGINEERING AND TECHNOLOGY
K. S. R. KALVI NAGAR,
TIRUCHENGODE-637 215,
NAMAKKAL DL, TAMIL NADU.

K S R INSTITUTE FOR ENGINEERING AND TECHNOLOGY
TIRUCHENGODE - 637 215

DATE: 28.09.2018

EXAMINATION CONTROL OFFICE

EXAM CIRCULAR

It is to inform all HoDs, Faculty Members and UG first year students that the Internal Assessment Test - I commences on 10.10.2018 (Wednesday).

Timing : 11.00 am to 12.40 pm

Circulated to all departments

The Test Schedule is given below:

DATE	DAY	CSE	EEE	ECE	MECH	IT
10.10.2018	Wednesday	PSP	EC	PSP	EC	PSP
11.10.2018	Thursday	EC	PSP	EC	PSP	EC
12.10.2018	Friday	EP	CE	EP	CE	EP
13.10.2018	Saturday	EM-I	EM-I	EM-I	EG	EG
15.10.2018	Monday	CE	EP	CE	EP	CE
16.10.2018	Tuesday	EG	EG	EG	EM-I	EM-I

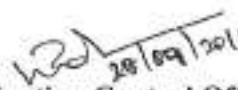
28/09/2018
Examination Control Office
(Coordinator)

Principal

PRINCIPAL,
K. S. R. INSTITUTE FOR
ENGINEERING AND TECHNOLOGY,
K. S. R. KALVI NAGAR,
TIRUCHENGODE-637 215,
NAMAKKAL DISTRICT, TAMIL NADU.

K S R INSTITUTE FOR ENGINEERING AND TECHNOLOGY
TIRUCHENGODE - 637 215

DATE: 03.10.2018

EXAMINATION CONTROL OFFICE

EXAM CIRCULAR

It is to inform all HoDs, Faculty Members and UG II, III & IV year students that the Internal Assessment Test - III commences on 10.10.2018 (Wednesday).

Timing: 1.30pm - 4.00pm

Circulated to all departments

The Test Schedule is given below:

II - YEAR

DATE	DAY	CSE	EEE	ECE -A	ECE- B	MECH A&B	IT
10.10.2018	Wednesday	CE	PPE	DE	DE	TPDE	DM
11.10.2018	Thursday	OOPS	EMT	EC-I	EC-I	ETD	DPSD
12.10.2018	Friday	DS	EDC	SS	SS	FMM	DS
13.10.2018	Saturday	-	TPDE	FDSC	LAPDE	MT-I	OOP
15.10.2018	Monday	DPSD	DLC	CSE	CSE	EDC	ADC
16.10.2018	Tuesday	DM	EM-I	LAPDE	FDSC	-	-

III - YEAR

DATE	DAY	CSE	EEE	ECE - A	ECE- B	MECH A & B	IT
10.10.2018	Wednesday	OOAD	MPMC	PDSP	PDSP	CAD	CN
11.10.2018	Thursday	IP	PE	ESE	TLWG	HMT	GM
12.10.2018	Friday	CG	PPE	MPMC	MPMC	DME	OOAD
13.10.2018	Saturday	DM	CS	DC	DC	MM	DSP
15.10.2018	Monday	-	EM-II	TLWG	ESE	DOM	WP
16.10.2018	Tuesday	TOC	PSA	-	-	PEE	WC

IV - YEAR

DATE	DAY	CSE	EEE A	EEE B	ECE -A	ECE- B	MECH A&B&C	IT
10.10.2018	Wednesday	CNS	FOLI	MBSD	RFMW	ACA	PPE	IM
11.10.2018	Thursday	GCC	HVE	FOLI	DIP	DIP	MECH	CNS
12.10.2018	Friday	SOA	PPE	PSG	ERTS	ERTS	CIM	DWDM
13.10.2018	Saturday	IR	MBSD	HVE	OCN	OCN	TQM	GCC
15.10.2018	Monday	GTA	POM	SEM	OED	OED	PPCE	ASN
16.10.2018	Tuesday	RMT	PSG	POM	RFMW	ACA	ROB	

Exam Head

Principal

PRINCIPAL,
K. S. R. INSTITUTE FOR
ENGINEERING AND TECHNOLOGY,
K. S. R. KALVI NAGAR,
TIRUCHENGODE-637 215,
NAMAKKAL DI. TAMIL NADU.

K S R INSTITUTE FOR ENGINEERING AND TECHNOLOGY
TIRUCHENGODE - 637 215

DATE: 03.10.2018

EXAMINATION CONTROL OFFICE

EXAM CIRCULAR

It is to inform all HoDs, Faculty Members and PG I & II year students that the Internal Assessment Test - III commences on 10.10.2018 (Wednesday).

Timing: 1.30pm - 4.00pm

Circulated to all departments

The Test Schedule is given below:

II - YEAR

DATE	DAY	CAD/CAM	CSE	EST	SE
10.10.2018	Wednesday	PLM	SQAT	SCOT	WDM
11.10.2018	Thursday	MNDT	SNA	WMC	UIDE
12.10.2018	Friday	QMT	MAD	CNS	SOAD

Exam Head

Principal

PRINCIPAL,
K. S. R. INSTITUTE FOR
ENGINEERING AND TECHNOLOGY,
K. S. R. KALVI NAGAR,
TIRUCHENGODE-637 215,
NAMAKKAL DI. TAMIL NADU.

K S R INSTITUTE FOR ENGINEERING AND TECHNOLOGY
TIRUCHENGODE - 637 215

DATE: 03.10.2018

EXAMINATION CONTROL OFFICE

EXAM CIRCULAR

It is to inform all HoDs, Faculty Members and PG I year students that the Internal Assessment Test - I commences on 10.10.2018 (Wednesday).

Timing: 11.00am -12.40pm

Circulated to all departments

The Test Schedule is given below:

I - YEAR

DATE	DAY	CSE	EST	SE
10.10.2018	Wednesday	APS	AMEE	APS
11.10.2018	Thursday	ADSA	ADPD	ADSA
12.10.2018	Friday	ACA	MBSD	SA
13.10.2018	Saturday	OSI	DES	ASE
15.10.2018	Monday	ASE	SES	SRE
16.10.2018	Tuesday	MLT	DI	-

Exam Head

Principal

PRINCIPAL,
K. S. R. INSTITUTE FOR
ENGINEERING AND TECHNOLOGY,
K. S. R. KALVI NAGAR,
TIRUCHENGODE-637 215,
NAMAKKAL DL, TAMIL NADU.

K S R INSTITUTE FOR ENGINEERING AND TECHNOLOGY
TIRUCHENGODE - 637 215

DATE: 22.10.2018

EXAMINATION CONTROL OFFICE

EXAM CIRCULAR

It is to inform all HoDs, Faculty Members and UG first year students that the Internal Assessment Test - II commences on 01.11.2018 (Thursday).

Timing : 11.00 am to 12.40 pm

Circulated to all departments

The Test Schedule is given below:

DATE	DAY	CSE	EEE	ECE	MECH	IT
01.11.2018	Thursday	EM-I	EM-I	EM-I	EG	EG
02.11.2018	Friday	PSP	EC	PSP	EC	PSP
03.11.2018	Saturday	EP	CE	EP	CE	EP
08.11.2018	Thursday	EC	PSP	EC	PSP	EC
09.11.2018	Friday	EG	EG	EG	EM-I	EM-I
10.11.2018	Saturday	CE	EP	CE	EP	CE

W2
22/10/2018
Examination Control Office
(Coordinator)

[Signature]
22/10/18
Principal

[Signature]
PRINCIPAL,
K. S. R. INSTITUTE FOR
ENGINEERING AND TECHNOLOGY,
K. S. R. KALVI NAGAR,
TIRUCHENGODE-637 215,
NAMAKKAL DI, TAMIL NADU.

K S R INSTITUTE FOR ENGINEERING AND TECHNOLOGY

TIRUCHENGODE - 637 215

DATE: 26.10.2018

EXAMINATION CONTROL OFFICE

EXAM CIRCULAR

It is to inform all HoDs, Faculty Members and PG I year students that the Internal Assessment Test - II commences on 01.11.2018 (Friday).

Timing: 11.00am -12.40pm

Circulated to all departments

The Test Schedule is given below:

I - YEAR

DATE	DAY	CSE	EST	SE
01.11.2018	Thursday	APS	AMEE	APS
02.11.2018	Friday	ADSA	ADPD	ADSA
03.11.2018	Saturday	ACA	MBSD	SA
08.11.2018	Thursday	OSI	DES	ASE
09.11.2018	Friday	ASE	SES	SRE
10.11.2018	Saturday	MLT	DI	-

Exam Head

Principal

PRINCIPAL,
K. S. R. INSTITUTE FOR
ENGINEERING AND TECHNOLOGY,
K. S. R. KALVI NAGAR,
TIRUCHENGODE-637 215,
NAMAKKAL Dt, TAMIL NADU.

K S R INSTITUTE FOR ENGINEERING AND TECHNOLOGY
TIRUCHENGODE - 637 215

DATE: 15.11.2018

EXAMINATION CONTROL OFFICE

EXAM CIRCULAR

It is to inform all HoDs, Faculty Members and UG first year students that the Internal Assessment Test - III commences on 03.12.2018 (Monday).

Timing : 1.30 pm to 4.00 pm

Circulated to all departments

The Test Schedule is given below:

DATE	DAY	CSE	EEE	ECE	MECH	IT
03.12.2018	Monday	EM-I	EM-I	EM-I	EP	EP
04.12.2018	Tuesday	EC	EP	EC	EM-I	EM-I
05.12.2018	Wednesday	EP	EC	EP	EC	EC
06.12.2018	Thursday	CE	PSP	CE	CE	PSP
07.12.2018	Friday	PSP	CE	PSP	PSP	CE
08.12.2018	Saturday	EG	EG	EG	EG	EG

15/11/2018
Examination Control Office
(Coordinator)

15/11/2018
PRINCIPAL,
K. S. R. INSTITUTE FOR
ENGINEERING AND TECHNOLOGY,
K. S. R. KALVI NAGAR,
TIRUCHENGODE-637 215,
NAMAKKAL DL. TAMIL NADU.

15/11/2018
Principal

K S R INSTITUTE FOR ENGINEERING AND TECHNOLOGY
TIRUCHENGODE - 637 215

DATE: 27.11.2018

EXAMINATION CONTROL OFFICE

EXAM CIRCULAR

It is to inform all HoDs, Faculty Members and PG I year students that the Internal Assessment Test - III commences on 03.12.2018 (Monday).

Timing: 01.30am -04.00pm

Circulated to all departments

The Test Schedule is given below:

I - YEAR

DATE	DAY	CSE	EST	SE
03.12.2018	Monday	APS	AMEE	APS
04.12.2018	Tuesday	ADSA	ADPD	ADSA
05.12.2018	Wednesday	ACA	MBSD	SA
06.12.2018	Thursday	OSI	DES	ASE
07.12.2018	Friday	ASE	SES	SRE
08.12.2018	Saturday	MLT	DI	-

Exam Head

Principal

PRINCIPAL,
K. S. R. INSTITUTE FOR
ENGINEERING AND TECHNOLOGY,
K. S. R. KALVI NAGAR,
TIRUCHENGODE-637 215,
NAMAKKAL Dt. TAMIL NADU.

EXAMINATION CONTROL OFFICE

EXAM CIRCULAR

It is to inform all HoDs, Faculty Members and UG IV year students that the Internal Assessment Test - I commences on 22.01.2019 (Tuesday).

Timing: 11.00am -12.40pm

Circulated to all departments

The Test Schedule is given below:

IV - YEAR

DATE	DAY	CSE	EEE A&B	ECE A&B	MECH A&B&C	IT
22.01.2019	Tuesday	MCAP	EEGUC	WC	EE	SOA
23.01.2019	Wednesday	HCI	PERES	WN	PPC	CF
24.01.2019	Thursday	PEE	PEE	PEE	AIC	PEE
25.01.2019	Friday			ED		SPM

Exam Head

Principal

PRINCIPAL
K. S. R. INSTITUTE FOR
ENGINEERING AND TECHNOLOGY
K. S. R. KALVI NAGAR,
TIRUCHENGODE-637 215.
NANAKKAL DI, TAMIL NADU.

EXAMINATION CONTROL OFFICE

EXAM CIRCULAR

It is to inform all HoDs, Faculty Members and UG II, III year students that the Internal Assessment Test - I & Internal Assessment Test - II for IV year students are commences on 06.02.2019 (Wednesday).

Timing: 11.00pm - 12.40pm

Circulated to all departments

The Test Schedule is given below:

II - YEAR

DATE	DAY	CSE	EEE	ECE - A & B	MECH A&B	IT
06.02.2019	Wednesday	PQT	CS	PRP	SNM	P&S
07.02.2019	Thursday	CA	T&D	EMF	KOM	ESE
08.02.2019	Friday	DBMS	EM-II	EC-II	MT-II	CA
11.02.2019	Monday-FN	DAA	M&I	CT	EM	DBMS
11.02.2019	Monday-AN	OS	LIC	ESE	SOMME	DAA
12.02.2019	Tuesday	SE	NM	LIC	TE-I	OS

III - YEAR

DATE	DAY	CSE	EEE	ECE - A	ECE- B	MECH A & B	IT
06.02.2019	Wednesday	DS	CE	CA	CA	DTS	DS
07.02.2019	Thursday	DSP	SSD	VLSI	AWP	POM	MC
08.02.2019	Friday	MC	ES	POM	POM	AE	AI
11.02.2019	Monday-FN	CD	DEM	ME	ME	FEA	CD
11.02.2019	Monday-AN	AI	PSOC	AWP	VLSI	GDJP	SA
12.02.2019	Tuesday	TQM	PST	CN	CN	UCM	TQM

IV - YEAR

DATE	DAY	CSE	EEE A & B	ECE - A&B	MECH A&B&C	IT
06.02.2019	Wednesday	MCAP	PERES	WC	EE	SOA
07.02.2019	Thursday	HCI	EEGUC	WN	PPC	SPM
08.02.2019	Friday	PEE	PEE	PEE	AIC	PEE
11.02.2019	Monday	-	-	ED	-	CF

Exam Head

PRINCIPAL,
K. S. R. INSTITUTE FOR
ENGINEERING AND TECHNOLOGY,
K. S. R. KALVI NAGAR,
TIRUCHENGODE - 637 215.

Principal

K S R INSTITUTE FOR ENGINEERING AND TECHNOLOGY
TIRUCHENGODE - 637 215

DATE: 29.01.2019

EXAMINATION CONTROL OFFICE

EXAM CIRCULAR

It is to inform all HoDs, Faculty Members and PG I year students that the Internal Assessment Test - I commences on 06.02.2019 (Wednesday).

Timing: 11.00pm - 12.40pm

Circulated to all departments

The Test Schedule is given below:

I - YEAR

DATE	DAY	CSE	EST	SE
06.02.2019	Wednesday	NDT	RTOS	STMQA
07.02.2019	Thursday	SP	PDT	SI
08.02.2019	Friday	IOT	RPAP	SRMM
11.02.2019	Monday-FN	BDA	IOT	ADB
11.02.2019	Monday-AN	CCT	EPD	CCT
12.02.2019	Tuesday	MPC	RPSD	SW

Exam Head

Principal

PRINCIPAL
K. S. R. INSTITUTE FOR
ENGINEERING AND TECHNOLOGY,
K. S. R. KALVI NAGAR,
TIRUCHENGODE-637 215,
NAMAKKAL DI, TAMIL NADU.

K S R INSTITUTE FOR ENGINEERING AND TECHNOLOGY
TIRUCHENGODE - 637 215

DATE: 11.02.2019

EXAMINATION CONTROL OFFICE

EXAM CIRCULAR

It is to inform all HoDs, Faculty Members and UG first year students that the **Internal Assessment Test - I** commences on **28.02.2019 (Thursday)**.

Timing : 11.00 am to 12.30 pm

Circulated to all departments

The Test Schedule is given below:

DATE	DAY	CSE	EEE	ECE	MECH	IT
28.02.2019	Thursday	PC	CT	CA	BEEIE	ITE
01.03.2019	Friday	EVS	EVS	PFE	EVS	PFI
02.03.2019	Saturday	TE	TE	EM II	EM II	TE
04.03.2019	Monday	BEEME	BCME	ED	EM	PC
05.03.2019	Tuesday	EM II	EM II	TE	TE	EM II
06.03.2019	Wednesday	PFI	PFE	BEEIE	MS	BEEME

Examination Control Office
(Coordinator)

PRINCIPAL,
K. S. R. INSTITUTE FOR
ENGINEERING AND TECHNOLOGY,
K. S. R. KALVI NAGAR,
TIRUCHENGODE-637 215,
NAMAKKAL DL, TAMIL NADU.

Principal

K S R INSTITUTE FOR ENGINEERING AND TECHNOLOGY
TIRUCHENGODE - 637 215

DATE: 18.02.2019

EXAMINATION CONTROL OFFICE

EXAM CIRCULAR

It is to inform all HoDs, Faculty Members and UG II, III students that the Internal Assessment Test - II & Internal Assessment Test - 3 for IV year students are commences on 25.02.2019 (Monday).

Timing: 01.00 pm -04.00 pm

Circulated to all departments

The Test Schedule is given below:

II - YEAR

DATE	DAY	CSE	EEE	ECE - A&B	MECH A&B	IT
25.02.2019	Monday	PQT	CS	PRP	MT-II	PQT
26.02.2019	Tuesday	CA	EM-II	EMF	KOM	ESE
27.02.2019	Wednesday	DBMS	T&D	EC-II	EM	CA
28.02.2019	Thursday	DAA	M&I	CT	TE	DBMS
01.03.2019	Friday	OS	LIC	ESE	SOMME	DAA
02.03.2019	Saturday	SE	NM	LIC	SNM	OS

III - YEAR

DATE	DAY	CSE	EEE	ECE -A	ECE- B	MECH A & B	IT
25.02.2019	Monday	DS	CE	CA	CA	DTS	DS
26.02.2019	Tuesday	DSP	SSD	VLSI	AWP	POM	MC
27.02.2019	Wednesday	MC	ES	POM	POM	AE	AI
28.02.2019	Thursday	CD	PSOC	ME	ME	FEA	CD
01.03.2019	Friday	AI	DEM	AWP	VLSI	GDJB	SA
02.03.2019	Saturday	TQM	PST	CN	CN	UCM	TQM

IV - YEAR

DATE	DAY	CSE	EEE A&B	ECE A&B	MECH A&B&C	IT
25.02.2019	Monday	MCAP	EEGUC	WC	EE	SOA
26.02.2019	Tuesday	HCI	PERES	WN	PPC	SPM
27.02.2019	Wednesday	PEE	PEE	PEE	AIC	PEE
28.02.2019	Thursday	-	-	ED	-	CF

Exam Head

PRINCIPAL

Principal

K. S. R. INSTITUTE FOR
ENGINEERING AND TECHNOLOGY,
K. S. R. KALVI NAGAR,
TIRUCHENGODE 637 215,
NAMAKKAL DISTRICT, TAMIL NADU.

K S R INSTITUTE FOR ENGINEERING AND TECHNOLOGY
TIRUCHENGODE - 637 215

DATE: 18.02.2019

EXAMINATION CONTROL OFFICE

EXAM CIRCULAR

It is to inform all HoDs, Faculty Members and PG 1 year students that the Internal Assessment Test - II commences on 25.02.2019 (Monday).

Timing: 01.00pm - 04.00pm

Circulated to all departments

The Test Schedule is given below:

I - YEAR

DATE	DAY	CSE	EST	SE
25.02.2019	Monday	NDT	RTOS	STMQA
26.02.2019	Tuesday	SP	PDT	SI
27.02.2019	Wednesday	IOT	RPAP	SRMM
28.02.2019	Thursday	BDA	IOT	ADB
01.03.2019	Friday	CCT	EPD	CCT
02.03.2019	Saturday	MPC	RPSD	SW

Exam Head

Principal

PRINCIPAL
K. S. R. INSTITUTE FOR
ENGINEERING AND TECHNOLOGY
K. S. R. KALVINAGODH
TIRUCHENGODE - 637 215
NAMAKKAL DISTRICT, TAMIL NADU

K S R INSTITUTE FOR ENGINEERING AND TECHNOLOGY
TIRUCHENGODE - 637 215

DATE: 05.03.2019

EXAMINATION CONTROL OFFICE

EXAM CIRCULAR

It is to inform all HoDs, Faculty Members and UG II, III students that the Internal Assessment Test - III & Model Examination for IV year students are commences on 15.03.2019 (Friday).

Timing: 01.00 pm -04.00 pm

Circulated to all departments

The Test Schedule is given below:

II - YEAR

DATE	DAY	CSE	EEE	ECE - A&B	MECH A&B	IT
15.03.2019	Friday	PQT	CS	PRP	MT-II	PQT
16.03.2019	Saturday	CA	EM-II	EMF	KOM	ESE
18.03.2019	Monday	DBMS	NM	EC-II	EM	CA
19.03.2019	Tuesday	DAA	M&i	CT	TE	DBMS
20.03.2019	Wednesday	OS	LIC	ESE	SOMME	DAA
21.03.2019	Thursday	SE	T&D	LIC	SNM	OS

III - YEAR

DATE	DAY	CSE	EEE	ECE - A	ECE - B	MECH A & B	IT
15.03.2019	Friday	DS	CE	CA	CA	DTS	DS
16.03.2019	Saturday	DSP	SSD	VLSI	AWP	POM	MC
18.03.2019	Monday	MC	ES	POM	POM	AE	AI
19.03.2019	Tuesday	CD	PSOC	ME	ME	FEA	CD
20.03.2019	Wednesday	AI	DEM	AWP	VLSI	GDJB	SA
21.03.2019	Thursday	TQM	PST	CN	CN	UCM	TQM

IV - YEAR

DATE	DAY	CSE	EEE A&B	ECE A&B	MECH A&B&C	IT
19.03.2019	Tuesday	PEE	PEE	PEE	AIC	PEE
22.03.2019	Friday	MCAP	EEGUC	WC	EE	SOA
26.03.2019	Tuesday	HCI	PERES	WN	PPC	CF
29.03.2019	Friday			ED	-	SPM

Exam Head

PRINCIPAL
K. S. R. INSTITUTE FOR
ENGINEERING AND TECHNOLOGY,
K. S. R. KALVI NAGAR,
TIRUCHENGODE-637 215,
NAMAKKAL DL, TAMIL NADU.

Principal

K S R INSTITUTE FOR ENGINEERING AND TECHNOLOGY
TIRUCHENGODE - 637 215

DATE: 05.03.2019

EXAMINATION CONTROL OFFICE

EXAM CIRCULAR

It is to inform all HoDs, Faculty Members and PG I year students that the Internal Assessment Test - III commences on 15.03.2019 (Friday).

Timing: 01.00pm - 04.00pm

Circulated to all departments

The Test Schedule is given below:

I - YEAR

DATE	DAY	CSE	EST	SE
15.03.2019	Friday	NDT	RTOS	STMQA
16.03.2019	Saturday	SP	PDT	SI
18.03.2019	Monday	IOT	RPAP	SRMM
19.03.2019	Tuesday	BDA	IOT	ADB
20.03.2019	Wednesday	CCT	EPD	CCT
21.03.2019	Thursday	MPC	RPSD	SW

Exam Head

Principal

PRINCIPAL
K. S. R. INSTITUTE FOR
ENGINEERING AND TECHNOLOGY,
K. S. R. KALVI NAGAR,
TIRUCHENGODE-637 215,
NAMAKKAL Dt. TAMIL NADU.

K S R INSTITUTE FOR ENGINEERING AND TECHNOLOGY
TIRUCHENGODE - 637 215

DATE: 11.03.2019

EXAMINATION CONTROL OFFICE

EXAM CIRCULAR

It is to inform all HoDs, Faculty Members and UG first year students that the Internal Assessment Test - II commences on 22.03.2019 (Friday).

Timing : 12.00 noon to 12.45 pm

Circulated to all departments

The Test Schedule is given below:

DATE	DAY	CSE	EEE	ECE	MECH	IT
22.03.2019	Friday	TE	TE	EM II	EM II	TE
23.03.2019	Saturday	BEEME	BCME	PFE	MS	PFI
25.03.2019	Monday	EVS	EVS	BEIE	EVS	BEEME
26.03.2019	Tuesday	PFI	PFE	CA	BEEIE	ITE
27.03.2019	Wednesday	EM II	EM II	TE	TE	EM II
28.03.2019	Thursday	PC	CT	ED	EM	PC

Examination Control Office
(Coordinator)

Principal

PRINCIPAL,
K. S. R. INSTITUTE FOR
ENGINEERING AND TECHNOLOGY,
K. S. R. KALVI NAGAR,
TIRUCHENGODE-637 215,
NATAKAL DI TAMIL NADU.

K S R INSTITUTE FOR ENGINEERING AND TECHNOLOGY
TIRUCHENGODE - 637 215

DATE: 01.04.2019

EXAMINATION CONTROL OFFICE

EXAM CIRCULAR

It is to inform all HoDs, Faculty Members and UG first year students that the Internal Assessment Test - III commences on 11.04.2019 (Thursday).

Timing : 12.00 noon to 12.45 pm

Circulated to all departments

The Test Schedule is given below:

DATE	DAY	CSE	EEE	ECE	MECH	IT
11.04.2019	Thursday	EM II	EM II	PFE	MS	EM II
12.04.2019	Friday	PFI	PFE	TE	TE	PFI
13.04.2019	Saturday	PC	CT	BEIE	EM	BEEME
15.04.2019	Monday	TE	TE	CA	BEEIE	TE
16.04.2019	Tuesday	BEEME	BCME	ED	EVS	PC
18.04.2019	Thursday	EVS	EVS	EM II	EM II	ITE

W21
21/4/2019
Examination Control Office
(Coordinator)

10/16/19
Principal

10/16/19
PRINCIPAL,
K. S. R. INSTITUTE FOR
ENGINEERING AND TECHNOLOGY,
K. S. R. KALVI NAGAR,
TIRUCHENGODE - 637 215,
NAMAKKAL DL, TAMIL NADU.

K S R INSTITUTE FOR ENGINEERING AND TECHNOLOGY
TIRUCHENGODE - 637 215

DATE: 05.07.2019

EXAMINATION CONTROL OFFICE

EXAM CIRCULAR

It is to inform all HoDs, Faculty Members and UG II, III & IV year students that the Internal Assessment Test - I commences on 15.07.2019 (Monday).

Timing: 11.00am -12.35pm

Circulated to all departments

The Test Schedule is given below:

II - YEAR

DATE	DAY	CSE	EEE	ECE	MECH	IT
15.07.2019	Monday	OOPS	DLC	LAPDE	MT -1	DPSD
16.07.2019	Tuesday	DPSD	TPDE	EC I	EDC	DS
17.07.2019	Wednesday	DM	EM-I	CSE	ETD	OOP
18.07.2019	Thursday	CE	EDC	DE	TPDE	ADC
19.07.2019	Friday	DS	EMT	FDSC	FMM	DM
20.07.2019	Saturday	-	PPE	SS	-	-

III - YEAR

DATE	DAY	CSE	EEE	ECE A & B	MECH A & B	IT
15.07.2019	Monday	OOAD	PSA	ME	TE-II	CN
16.07.2019	Tuesday	MPMC	DSP	DSP	DME	MP
17.07.2019	Wednesday	CN	PE	DC	MM	WT
18.07.2019	Thursday	ANT	MPMC	CN	DOM	SE
19.07.2019	Friday	TOC	OOPS	RES	ICE	HWM
20.07.2019	Saturday	HWM	S&T	CA	-	ANT

IV - YEAR

DATE	DAY	CSE	EEE	ECE A & B	MECH A & B	IT
15.07.2019	Monday	GTA	PSG	ERTS	PPE	IM
16.07.2019	Tuesday	CNS	POM	DIP	MECT	CNS
17.07.2019	Wednesday	SOA	SEM	RFMW	CIM	GCC
18.07.2019	Thursday	IR	HVE	ACA	PPCE	ASN
19.07.2019	Friday	GCC	MBSD	OED	TQM	DWDM
20.07.2019	Saturday	RMT	FOLI	OCN	ROB	-

Exam Head

PRINCIPAL

Principal

K. S. R. INSTITUTE FOR
ENGINEERING AND TECHNOLOGY,
K. S. R. KALVINAGAR,
TIRUCHENGODE - 637 215.

K S R INSTITUTE FOR ENGINEERING AND TECHNOLOGY
TIRUCHENGODE – 637 215

DATE: 09.07.2019

EXAMINATION CONTROL OFFICE

EXAM CIRCULAR

It is to inform all HoDs, Faculty Members and PG II year students that the **Internal Assessment Test – I** commences on 15.07.2019 (Monday).

Timing: 11.00am -12.35pm

Circulated to all departments

The Test **Schedule** is given below:

II – YEAR

DATE	DAY	EST	SE	CSE
15.07.2019	Monday	SCOT	ISPM	SCAT
16.07.2019	Tuesday	WMC	WDM	SNA
17.07.2019	Wednesday	CNS	UIDE	MAD
18.07.2019	Thursday	-	SOAD	-

Exam Head

Principal

PRINCIPAL
K. S. R. INSTITUTE FOR
ENGINEERING AND TECHNOLOGY,
K. S. R. KALVI NAGAR,
TIRUCHENGODE - 637 215.
Principal

EXAMINATION CONTROL OFFICE

EXAM CIRCULAR

It is to inform all HoDs, Faculty Members and UG II, III & IV year students that the Internal Assessment Test - II commences on 26.08.2019 (Monday).

Timing: 1.00pm -4.00pm

Circulated to all departments

The Test Schedule is given below:

II - YEAR

DATE	DAY	CSE	EEE	ECE	MECH	IT
26.08.2019	Monday	DPSD	TPDE	EC I	MT -1	DPSD
27.08.2019	Tuesday	DM	DLC	CSE	EDC	DS
28.08.2019	Wednesday	DS	PPE	DE	TPDE	OOP
29.08.2019	Thursday	CE	EDC	LAPDE	ETD	ADC
30.08.2019	Friday	OOPS	EMT	FDSC	FMM	DM
31.08.2019	Saturday	-	EM-1	SS	-	-

III - YEAR

DATE	DAY	CSE	EEE	ECE A & B	MECH A & B	IT
26.08.2019	Monday	CN	PSA	ME	ICE	CN
27.08.2019	Tuesday	OOAD	DSP	DSP	MM	MP
28.08.2019	Wednesday	MPMC	PE	DC	DME	WT
29.08.2019	Thursday	ANT	MPMC	CN	DOM	SE
30.08.2019	Friday	TOC	OOPS	RES	TE-II	HWM
31.08.2019	Saturday	HWM	S&T	CA	-	ANT

IV - YEAR

DATE	DAY	CSE	EEE	ECE A	ECE B	MECH A & B	IT
26.08.2019	Monday	IR	PSG	ERTS	ERTS	ROB	IM
27.08.2019	Tuesday	CNS	POM	DIP	DIP	TQM	CNS
28.08.2019	Wednesday	SOA	SEM	OCN	RFMW	CIM	GCC
29.08.2019	Thursday	GCC	HVE	ACA	ACA	PPE	ASN
30.08.2019	Friday	GTA	FOLI	OED	OED	PPCE	DWDM
31.08.2019	Saturday	RMT	MBSD	RFMW	OON	MECT	

Exam Head

PRINCIPAL
 K. S. R. INSTITUTE FOR
 ENGINEERING AND TECHNOLOGY,
 K. S. R. KALVINAGAR
 TIRUCHENGODE

Principal

K S R INSTITUTE FOR ENGINEERING AND TECHNOLOGY
TIRUCHENGODE - 637 215

DATE: 22.08.2019

EXAMINATION CONTROL OFFICE

EXAM CIRCULAR

It is to inform all HoDs, Faculty Members and PG II year students that the Internal Assessment Test - II commences on 26.08.2019 (Monday).

Timing: 01.00pm -04.00pm

Circulated to all departments

The Test Schedule is given below:

II - YEAR

DATE	DAY	EST	SE	CSE
26.08.2019	Monday	SCOT	ISPM	SCAT
27.08.2019	Tuesday	WMC	WDM	SNA
28.08.2019	Wednesday	CNS	UIDE	MAD
29.08.2019	Thursday	-	SOAD	-

Exam Head

Principal

PRINCIPAL,
K. S. R. INSTITUTE FOR
ENGINEERING AND TECHNOLOGY,
K. S. R. KALVI NAGAR,
TIRUCHENGODE-637 215,
KANNIYAKUMARI DISTRICT, TAMIL NADU.

K S R INSTITUTE FOR ENGINEERING AND TECHNOLOGY
TIRUCHENGODE - 637 215

DATE: 21.08.2019

EXAMINATION CONTROL OFFICE

EXAM CIRCULAR

It is to inform all HoDs, Faculty Members and UG first year students that the Internal Assessment Test - I commences on 03.09.2019 (Tuesday).

Timing : 11.00 am to 12.30 pm

Circulated to all departments

The Test Schedule is given below:

DATE	DAY	CSE	EEE	ECE	MECH	IT
03.09.2019	Tuesday	PSP	EP	EP	EP	PSP
04.09.2019	Wednesday	EC	PSP	PSP	CE	EC
05.09.2019	Thursday	CE	EM-I	EM-I	PSP	CE
06.09.2019	Friday	EP	EC	EC	EC	EP
07.09.2019	Saturday	EM-I	CE	CE	EM-I	EM-I
09.09.2019	Monday	EG	EG	EG	EG	EG

21/8/2019
Examination Control Office
(Coordinator)

PRINCIPAL
K. S. R. INSTITUTE FOR
ENGINEERING AND TECHNOLOGY,
K. S. R. KALVI NAGAR,
TIRUCHENGODE-637 215,
NAMAKKAL DISTRICT, TAMIL NADU.

Principal

K S R INSTITUTE FOR ENGINEERING AND TECHNOLOGY
TIRUCHENGODE – 637 215

DATE: 28.08.2019

EXAMINATION CONTROL OFFICE

EXAM CIRCULAR

It is to inform all HoDs, Faculty Members and PG I year students that the Internal Assessment Test - I commences on 03.09.2019 (Tuesday).

Timing: 11.00am -12.35pm

Circulated to all departments

The Test Schedule is given below:

I – YEAR

DATE	DAY	EST	CAD/CAM
03.09.2019	Tuesday	AMEE	AM
04.09.2019	Wednesday	ADPD	CAD
05.09.2019	Thursday	MBSD	CAM
06.09.2019	Friday	DES	CMS
07.09.2019	Saturday	SES	FEA
09.09.2019	Monday	DI	CCPP

Exam Head

Principal

PRINCIPAL
K. S. R. INSTITUTE FOR
ENGINEERING AND TECHNOLOGY,
K. S. R. KALVI NAGAR,
TIRUCHENGODE-637 215,
NAMBIAL DR. THIRU. NAJIG

EXAMINATION CONTROL OFFICE

INTERNAL ASSESSMENT TEST - III - SCHEDULE

It is to inform all HoDs, Faculty Members and UG II, III & IV year students that the Internal Assessment Test - III commences on 24.09.2019 (Tuesday).

Timing: Fore noon: 9.30am - 12.30pm Afternoon: 1.00pm - 4.00pm

Circulated to all departments

The Test Schedule is given below:

II - YEAR

DATE	DAY	CSE	EEE	ECE	MECH	IT
24.09.19 FN	Tuesday	DPSD	DLC	EC I	FMM	DPSD
25.09.19 AN	Wednesday	DS	PPE	CSE	EDC	DS
27.09.19 FN	Friday	CE	TPDE	DE	TPDE	OOP
30.09.19 AN	Monday	DM	EDC	LAPDE	MT-1	ADC
03.10.19 FN	Thursday	OOPS	EMT	FDSC	ETD	DM
04.10.19 AN	Friday	-	EM-I	SS	-	-

III - YEAR

DATE	DAY	CSE	EEE	ECE A & B	MECH A & B	IT
24.09.19 FN	Tuesday	CN	OOPS	ME	ICE	CN
25.09.19 AN	Wednesday	OOAD	DSP	DSP	TE-II	MP
27.09.19 FN	Friday	MPMC	PE	CN	DME	WT
30.09.19 AN	Monday	ANT	MPMC	DC	MM	SE
03.10.19 FN	Thursday	TOC	PSA	RES	DOM	HWM
04.10.19 AN	Friday	HWM	S&T	CA	-	ANT

IV - YEAR

DATE	DAY	CSE	EEE	ECE A	ECE B	MECH A & B	IT
24.09.19 FN	Tuesday	IR	PSG	ERTS	ERTS	PPE	IM
25.09.19 AN	Wednesday	CNS	POM	DIP	DIP	MECT	CNS
27.09.19 FN	Friday	SOA	HVE	OCN	RFMW	ROB	GCC
30.09.19 AN	Monday	RMT	MBSD	ACA	ACA	PPCE	ASN
03.10.19 FN	Thursday	GTA	FOLI	OED	OED	TQM	DWDM
04.10.19 AN	Friday	GCC	SEM	RFMW	OCN	CIM	

Exam Head

PRINCIPAL
K. S. R. INSTITUTE FOR
ENGINEERING AND TECHNOLOGY
 TIRUCHENGODE - 637 215

Principal

K S R INSTITUTE FOR ENGINEERING AND TECHNOLOGY
TIRUCHENGODE – 637 215

DATE: 18.09.2019

EXAMINATION CONTROL OFFICE

EXAM CIRCULAR

It is to inform all HoDs, Faculty Members and PG II year students that the Internal Assessment Test - III commences on 23.09.2019 (Monday).

Timing: 09.30am -12.30pm

Circulated to all departments

The Test Schedule is given below:

II – YEAR

DATE	DAY	EST	SE	CSE
23.09.2019	Monday	SCOT	ISPM	SCAT
24.09.2019	Tuesday	WMC	WDM	SNA
25.09.2019	Wednesday	CNS	UIDE	MAD
26.09.2019	Thursday	-	SOAD	-

Exam Head

Principal

PRINCIPAL,
K. S. R. INSTITUTE FOR
ENGINEERING AND TECHNOLOGY,
K. S. R. KALVI NAGAR,
TIRUCHENGODE-637 215,
NAMAKICAL DL. TAMIL NADU

K S R INSTITUTE FOR ENGINEERING AND TECHNOLOGY
TIRUCHENGODE – 637 215

DATE: 30.09.2019

EXAMINATION CONTROL OFFICE

EXAM CIRCULAR

It is to inform all HoDs, Faculty Members and PG I year students that the **Internal Assessment Test – II** commences on 03.10.2019 (Thursday).

Timing: 01.00pm -04.00pm

Circulated to all departments

The Test Schedule is given below:

I – YEAR

DATE	DAY	EST	CAD/CAM
03.10.2019	Thursday	AMEE	AM
04.10.2019	Friday	ADPD	CAD
09.10.2019	Wednesday	MBSD	CAM
10.10.2019	Thursday	DES	CMS
11.10.2019	Friday	SES	FEA
12.10.2019	Saturday	DI	CCPP

Exam Head

Principal

PRINCIPAL
K. S. R. INSTITUTE FOR
ENGINEERING AND TECHNOLOGY
K. S. R. KALVI NAGAR
TIRUCHENGODE-637 215.
NAMPALKAL DE. 14/09/2019

K S R INSTITUTE FOR ENGINEERING AND TECHNOLOGY
TIRUCHENGODE - 637 215

DATE: 03.10.2019

EXAMINATION CONTROL OFFICE

EXAM CIRCULAR

It is to inform all HoDs, Faculty Members and UG first year students that the Internal Assessment Test - II commences on 14.10.2019 (Monday).

Circulated to all departments

The Test Schedule is given below:

DATE	DAY	Subject	Branch	Duration	Branch	Duration
14.10.2019	Monday	CE	CSE & IT	10.00 am to 1.00 pm	EEE, ECE & MECH	1.00 pm to 4.00 pm
15.10.2019	Tuesday	EM - I				
16.10.2019	Wednesday	EG				
17.10.2019	Thursday	EP				
18.10.2019	Friday	EC				
19.10.2019	Saturday	PSP				

W2
23/10/2019
Examination Control Office
(Coordinator)

[Signature]
PRINCIPAL,
K. S. R. INSTITUTE FOR
ENGINEERING AND TECHNOLOGY,
K. S. R. KALVI NAGAR,
TIRUCHENGODE-637 215,
NAMAKKAL Dt. TAMIL NADU.

[Signature]
Principal

K S R INSTITUTE FOR ENGINEERING AND TECHNOLOGY
TIRUCHENGODE – 637 215

DATE: 23.10.2019

EXAMINATION CONTROL OFFICE

EXAM CIRCULAR

It is to inform all HoDs, Faculty Members and PG I year students that the **Internal Assessment Test - III** commences on 30.10.2019 (Wednesday).

Timing: 09.30am -12.30pm

Circulated to all departments

The Test Schedule is given below:

I – YEAR

DATE	DAY	EST	CAD/CAM
30.10.2019	Wednesday	AMEE	AM
31.10.2019	Thursday	ADPD	CAD
01.11.2019	Friday	MBSD	CAM
02.11.2019	Saturday	DES	CMS
04.11.2019	Monday	SES	FEA
05.11.2019	Tuesday	DI	CCPP

Exam Head

Principal

PRINCIPAL,
K. S. R. INSTITUTE FOR
ENGINEERING AND TECHNOLOGY,
K. S. R. KALVI NAGAR,
TIRUCHENGODE-637 215,
NAMAKKAL DI. TAMIL NADU.

K S R INSTITUTE FOR ENGINEERING AND TECHNOLOGY
TIRUCHENGODE - 637 215

DATE: 01.11.2019

EXAMINATION CONTROL OFFICE

EXAM CIRCULAR

It is to inform all HoDs, Faculty Members and UG first year students that the Internal Assessment Test - III commences on 14.11.2019 (Thursday).

Circulated to all departments

The Test Schedule is given below:

DATE	DAY	Subject	Branch	Duration	Branch	Duration
14.11.2019	Thursday	CE	EEE, ECE & MECH	10.00 am to 1.00 pm	CSE & IT	1.00 pm to 4.00 pm
15.11.2019	Friday	EM - I				
16.11.2019	Saturday	EG				
18.11.2019	Monday	EP				
19.11.2019	Tuesday	EC				
20.11.2019	Wednesday	PSP				

h24/11/2019
Examination Control Office
(Coordinator)

PRINCIPAL
K. S. R. INSTITUTE FOR
ENGINEERING AND TECHNOLOGY
K. S. R. KALVI NAGAR,
TIRUCHENGODE-637 215,
NAMAKKAL Dt. TAMIL NADU.

11/11/19
Principal

EXAMINATION CONTROL OFFICE

EXAM CIRCULAR

It is to inform all HoDs, Faculty Members and UG II, III & IV year students that the Internal Assessment Test - I commences on 27.01.2020 (Monday).

Timing: 1.00pm -4.00 pm

Circulated to all departments

The Test Schedule is given below:

II - YEAR

DATE	DAY	CSE	EEE	ECE	MECH	IT
27.01.2020	Monday	OS	M&I	ESE	MT -II	DBMS
28.01.2020	Tuesday	PQT	EM-II	PRP	SOMME	PS
29.01.2020	Wednesday	CA	T&D	EC-II	TE-1	CA
30.01.2020	Thursday	DAA	NM	EMF	SNM	EVS
31.01.2020	Friday	DBMS	LIC	CT	KM	DAA
01.02.2020	Saturday	SE	CS	LIC	EM	OS

III - YEAR

DATE	DAY	CSE	EEE	ECE	MECH	IT
27.01.2020	Monday	ST	SSD	MPMC	DTS	OOAD
28.01.2020	Tuesday	DS	PSG	VLSI	AE	CI
29.01.2020	Wednesday	CD	SEM	WC	HMT	MC
30.01.2020	Thursday	MC	DEA	POM	FEA	BDA
31.01.2020	Friday	AI	ES	WT	H&P	CGM
01.02.2020	Saturday	IP	-	TL&RFS	CIDM	ST

IV - YEAR

DATE	DAY	CSE	EEE	ECE	MECH	IT
27.01.2020	Monday	-	PERES	-	EE	SOA
28.01.2020	Tuesday	-	EEGUC	-	PPC	-
29.01.2020	Wednesday	HCI	PEE	WC	AIC	SPM
30.01.2020	Thursday	PEE		WN		
31.01.2020	Friday	MCAP		PEE		CF
01.02.2020	Saturday			ED		PEE

Exam Head

[Signature]
8-1-2020

PRINCIPAL

K. S. R. INSTITUTE FOR
ENGINEERING AND TECHNOLOGY,
K. S. R. KALVI NAGAR,
TIRUCHENGODE-637 215,
NAMAKKAL DI, TAMIL NADU.

Principal

[Signature]
8/1/2020

K S R INSTITUTE FOR ENGINEERING AND TECHNOLOGY
TIRUCHENGODE - 637 215

DATE: 24.01.2020

EXAMINATION CONTROL OFFICE

EXAM CIRCULAR

It is to inform all HoDs, Faculty Members and UG first year students that the Internal Assessment Test - I commences on 10.02.2020 (Monday).

Timing : 11.00 am to 12.30 pm

Circulated to all departments

The Test Schedule is given below:

DATE	DAY	CSE	EEE	ECE	MECH	IT
10.02.2020	Monday	TE	EM-II	EM-II	TE	TE
11.02.2020	Tuesday	BEEME	PFE	PFE	MS	BEEME
12.02.2020	Wednesday	PFI	EVS	ED	EM	PFI
13.02.2020	Thursday	PC	CT	BEEIE	BEEIE	PC
14.02.2020	Friday	EVS	BCME	CA	EVS	ITE
15.02.2020	Saturday	EM-II	TE	TE	EM-II	EM-II

Examination Control Office
(Coordinator)

PRINCIPAL,
K. S. R. INSTITUTE FOR
ENGINEERING AND TECHNOLOGY,
K. S. R. KALVI NAGAR,
TIRUCHENGODE-637 215,
NAMAKKAL DISTRICT, TAMIL NADU.

Principal

EXAMINATION CONTROL OFFICE

EXAM CIRCULAR

It is to inform all HoDs, Faculty Members and PG 1 year students that the Internal Assessment Test - I commences on 10.02.2020 (Monday).

Timing: 01.00pm -04.00pm

Circulated to all departments

The Test Schedule is given below:

I – YEAR

DATE	DAY	EST	CAD/CAM
10.02.2020	Monday	RTOS	DFMA
11.02.2020	Tuesday	PDT	AMT
12.02.2020	Wednesday	RPAP	MBM
13.02.2020	Thursday	IOT	IPPD
14.02.2020	Friday	EPD	ISM
15.02.2020	Saturday	RPSD	IMD

Exam Head

Principal

PRINCIPAL
K. S. R. INSTITUTE FOR
ENGINEERING AND TECHNOLOGY,
K. S. R. KALVI NAGAR,
TIRUCHENGODE-637 215,
NAMAKKAL DL, TAMIL NADU.

EXAMINATION CONTROL OFFICE**EXAM CIRCULAR**

It is to inform all HoDs, Faculty Members and UG II, III & IV year students that the Internal Assessment Test - II commences on 28.02.2020 (Friday).

Timing: 1.00pm -4.00 pm

Circulated to all departments

The Test Schedule is given below:

II - YEAR

DATE	DAY	CSE	EEE	ECE	MECH	IT
28.02.2020	Friday	DAA	M&I	EC-II	MT -II	DBMS
02.03.2020	Monday	PQT	T&D	LIC	TE -I	CA
03.03.2020	Tuesday	SE	LIC	ESE	SOMME	PS
04.03.2020	Wednesday	OS	NM	EMF	EM	OS
05.03.2020	Thursday	DBMS	EM-II	CT	SNM	DAA
06.03.2020	Friday	CA	CS	PRP	KM	ESE

III - YEAR

DATE	DAY	CSE	EEE	ECE	MECH	IT
28.02.2020	Friday	IP	DEA	MPMC	DTS	OOAD
02.03.2020	Monday	ST	SSD	VLSI	AE	ST
03.03.2020	Tuesday	DS	SEM	POM	HMT	CI
04.03.2020	Wednesday	CD	ES	WC	CIDM	CGM
05.03.2020	Thursday	MC	PSG	TL&RFS	H&P	MC
06.03.2020	Friday	AI	-	WT	FEA	BDA

IV - YEAR

DATE	DAY	CSE	EEE	ECE	MECH	IT
28.02.2020	Friday	HCI	PEE	-	PPC	SOA
02.03.2020	Monday	PEE	-	WC	AIC	PEE
03.03.2020	Tuesday	-	PERES	WN	EE	CF
04.03.2020	Wednesday	MCAP	-	PEE	-	SPM
05.03.2020	Thursday	-	EEGUC	ED	-	-

Exam Head

PRINCIPAL,
K. S. R. INSTITUTE FOR
ENGINEERING AND TECHNOLOGY,
K. S. R. KALVI NAGAR,
TIRUCHENGODE-637 215,
NAMAKKAL DI. TAMIL NADU.

Principal

K S R INSTITUTE FOR ENGINEERING AND TECHNOLOGY
TIRUCHENGODE - 637 215

DATE: 02.03.2020

EXAMINATION CONTROL OFFICE

EXAM CIRCULAR

It is to inform all HoDs, Faculty Members and UG first year students that the Internal Assessment Test - II commences on 20.03.2020 (Friday).

Timing : 1.00 pm to 4.00 pm

Circulated to all departments

The Test Schedule is given below:

DATE	DAY	CSE	EEE	ECE	MECH	IT
20.03.2020	Friday	TE	EM-II	EM-II	TE	TE
21.03.2020	Saturday	BEEME	PFE	PFE	MS	BEEME
23.03.2020	Monday	PFI	EVS	ED	EM	PFI
24.04.2020	Tuesday	PC	CT	BEEIE	BEEIE	PC
26.04.2020	Thursday	EVS	BCME	CA	EVS	ITE
27.04.2020	Friday	EM-II	TE	TE	EM-II	EM-II

h2ol 2/3/2020
Examination Control Office
(Coordinator)

[Signature]
Principal

PRINCIPAL,
K. S. R. INSTITUTE FOR
ENGINEERING AND TECHNOLOGY,
K. S. R. KALVI NAGAR,
TIRUCHENGODE-637 215.
TIRUCHENGODE, TAMIL NADU.

EXAMINATION CONTROL OFFICE

EXAM CIRCULAR

It is to inform all HoDs, Faculty Members and UG II, III & IV year students that the **Internal Assessment Test - III** commences on 18.03.2020 (Wednesday). All the faculty members are insisted to submit two set of question paper on or before 14.03.2020.

Timing: 2.30pm -4.00 pm

Circulated to all departments

The Test Schedule is given below:

II - YEAR

DATE	DAY	CSE	EEE	ECE	MECH	IT
18.03.2020	Wednesday	DAA	LIC	EC-II	MT -II	DBMS
19.03.2020	Thursday	PQT	T&D	LIC	TE -I	CA
20.03.2020	Friday	CA	M&I	ESE	SOMME	PS
21.03.2020	Saturday	OS	NM	EMF	EM	OS
23.03.2020	Monday	DBMS	EM-II	CT	SNM	DAA
24.03.2020	Tuesday	SE	CS	PRP	KM	ESE

III - YEAR

DATE	DAY	CSE	EEE	ECE	MECH	IT
18.03.2020	Wednesday	IP	ES	MPMC	FEA	OOAD
19.03.2020	Thursday	ST	SEM	VLSI	AE	ST
20.03.2020	Friday	DS	SSD	POM	HMT	CI
21.03.2020	Saturday	CD	PSG	WC	CIDM	CGM
23.03.2020	Monday	MC	DEA	TL&RFS	H&P	MC
24.03.2020	Tuesday	AI	-	WN	DTS	BDA

IV - YEAR

DATE	DAY	CSE	EEE	ECE	MECH	IT
18.03.2020	Wednesday	HCI	EEGUC	WC	PPC	SOA
19.03.2020	Thursday	MCAP	PERES	WN	EE	PEE
20.03.2020	Friday	PEE	PEE	PEE	-	CF
21.03.2020	Saturday		-	ED	AIC	SPM

Exam Head

PRINCIPAL,
K. S. R. INSTITUTE FOR
ENGINEERING AND TECHNOLOGY,
K. S. R. KALVI NAGAR,
TIRUCHENGODE-637 215,
NAMAKKAL DL TAMIL NADU.

Principal

K S R INSTITUTE FOR ENGINEERING AND TECHNOLOGY
TIRUCHENGODE – 637 215

DATE: 16.03.2020

EXAMINATION CONTROL OFFICE

EXAM CIRCULAR

It is to inform all HoDs, Faculty Members and PG 1 year students that the Internal Assessment Test – II commences on 20.03.2020 (Monday).

Timing: 01.00pm -04.00pm

Circulated to all departments

The Test Schedule is given below:

I – YEAR

DATE	DAY	EST	CAD/CAM
20.03.2020	Friday	RTOS	DFMA
21.03.2020	Saturday	PDT	AMT
23.03.2020	Monday	RPAP	MBM
24.03.2020	Tuesday	IOT	IPPD
26.03.2020	Thursday	EPD	ISM
27.03.2020	Friday	RPSD	IMD

Exam Head

Principal

PRINCIPAL
K. S. R. INSTITUTE FOR
ENGINEERING AND TECHNOLOGY,
K. S. R. KALVI NAGAR,
TIRUCHENGODE-637 215,
NAMAKKAL DL, TAMIL NADU.

K S R INSTITUTE FOR ENGINEERING AND TECHNOLOGY
TIRUCHENGODE – 637 215

DATE: 03.04.2020

EXAMINATION CONTROL OFFICE

EXAM CIRCULAR

It is to inform all HoDs, Faculty Members and PG I year students that the Internal Assessment Test - III commences on 09.04.2020 (Wednesday).

Timing: 02.30pm -04.00pm

Circulated to all departments

The Test Schedule is given below:

I – YEAR

DATE	DAY	EST	CAD/CAM
09.04.2020	Wednesday	RTOS	DFMA
10.04.2020	Thursday	PDT	AMT
11.04.2020	Friday	RPAP	MBM
15.04.2020	Saturday	IOT	IPPD
16.04.2020	Monday	EPD	ISM
17.04.2020	Tuesday	RPSD	IMD

Exam Head

Principal

PRINCIPAL
K. S. R. INSTITUTE FOR
ENGINEERING AND TECHNOLOGY,
K. S. R. KALVI NAGAR,
TIRUCHENGODE-637 215,
NAGARAKAL DU, TAMIL NADU.

Department of Electrical and Electronics Engineering

DUTY LIST

INTERNAL ASSESMENT TEST –I

ACADEMIC YEAR: 2018-19 ODD

DATE	Day	NAME OF THE FACULTY			
		M104	M105	M106	M107
17.08.2018	Friday	PKK	TSH	PSA	AJA
18. 08.2018	Saturday	RKU (MATHS)	TAD	KII	KMI
20. 08.2018	Monday	CSR	DDA	CSK	RSA
21. 08.2018	Tuesday	YKM	KMI	CSR	AJA
23. 08.2018	Thursday	TSH	PKK	AMS	CSK
24.08.2018	Friday	MSA (ECE)	DDA	YKM	TAD

Note:

- The faculty members should be present in **Power Electronics Lab (Ground Floor Main Block)** before **15mins** for collection of booklets.
- After completion of exam, submit the answer booklet in register number order to **Power Electronics Lab (Ground Floor Main Block)**.
- Faculty members should allow the students inside the exam hall after verifying **ID card and dress code**.

DEPT EXAM LEAD

PRINCIPAL,
K S R. INSTITUTE FOR
ENGINEERING AND TECHNOLOGY,
K. S. R. KALVI NAGAR,
TIRUCHENGODE-637 215,
NAMAKKAL Dt. TAMIL NADU.

EEE/HOD

Department of Electrical and Electronics Engineering

DUTY LIST

INTERNAL ASSESMENT TEST –II

ACADEMIC YEAR: 2018-19 ODD

DATE	Day	NAME OF THE FACULTY			
		M104	M105	M106	M107
14.09.2018	Friday	AMS	PSA	CSK	RSA
15.09.2018	Saturday	CSK	TAD	MSA (ECE)	DDA
17.09.2018	Monday	KII	PKK	TSH	TAD
18.09.2018	Tuesday	RKU (MATHS)	DDA	PKK	AJA
19.09.2018	Wednesday	KII	TSH	CSR	KMI
20.09.2018	Thursday	CSR	KMI	YKM	AJA

Note:

- The faculty members should be present in **Power Electronics Lab (Ground Floor Main Block)** before **15mins** for collection of booklets.
- After completion of exam, submit the answer booklet in register number order to **Power Electronics Lab (Ground Floor Main Block)**.
- Faculty members should allow the students inside the exam hall after verifying **ID card and dress code**.

DEPT EXAM LEAD

PRINCIPAL,
K. S. R. INSTITUTE FOR
ENGINEERING AND TECHNOLOGY,
K. S. R. KALVI NAGAR,
TIRUCHENGODE-637 215,
NAMAKKAL DI. TAMIL NADU.

EEE/HOD

K S R INSTITUTE FOR ENGINEERING AND TECHNOLOGY, TIRUCHENGODE - 637 215

EXAMINATION CONTROL OFFICE

INTERNAL ASSESSMENT TEST - I

I YEAR - INTERNAL HALL INVIGILATION DUTY CHART

EXAM TIMING : 11.00 AM TO 12.40 PM

DATE	HALL No.	M-403	M-404	M-405	M-408	M-409	M-205	MIC306
	DAY							
10.10.2018	WEDNESDAY	M.S (MECH)	B.M (CHE)	K.S (MAT)	D.K (IT)	S.C.D (CHE)	-	-
11.10.2018	THURSDAY	Dr.V.D.B (PHY)	S.P (MECH)	PM (ENG)	N.P (MAT)	Dr.D.M (PHY)	-	-
12.10.2018	FRIDAY	G.M (CSE)	R.B (MECH)	R.V (MECH)	G.A (MECH)	K.S (MAT)	-	-
13.10.2018	SATURDAY	-	Dr.S.S.K (PHY)	R.K (ENG)	L.D.P (IT)	-	S.M (ENG)	-
15.10.2018	MONDAY	S.P (MECH)	N.P (MAT)	Dr.D.M (PHY)	R.K (ENG)	Dr.V.D.B (PHY)	-	-
16.10.2018	TUESDAY	-	R.S.P (CSE)	B.M (CHE)	-	-	S.C.D (CHE)	PM (ENG)

h2
28/09/2018
Examination Control Office
(Coordinator)

h
PRINCIPAL,
K. S. R. INSTITUTE FOR
ENGINEERING AND TECHNOLOGY,
K. S. R. KALVI NAGAR,
TIRUCHENGODE-637 215,
NAMAKKAL DI, TAMIL NADU.

h
Principal

Department of Electrical and Electronics Engineering

DUTY LIST

INTERNAL ASSESMENT TEST –III

ACADEMIC YEAR: 2018-19 ODD

DATE	Day	NAME OF THE FACULTY			
		M104	M105	M106	M107
10.10.2018	Wednesday	TSH	KMI	DDA	AMS
11.10.2018	Thursday	MAS	AJA	CSR	DDA
12.10.2018	Friday	MSA (ECE)	CSK	PV	PSA
13.10.2018	Saturday	RKU (MATHS)	RSA	PKK	KII
15.10.2018	Monday	YKM	TAD	MAS	AJA
16.10.2018	Tuesday	TAD	CSR	TSH	CSK

Note:

- The faculty members should be present in **Power Electronics Lab (Ground Floor Main Block)** before **15mins** for collection of booklets.
- After completion of exam, submit the answer booklet in register number order to **Power Electronics Lab (Ground Floor Main Block)**.
- Faculty members should allow the students inside the exam hall after verifying **ID card and dress code**.

DEPT EXAM LEAD

PRINCIPAL,
K. S. R. INSTITUTE FOR
ENGINEERING AND TECHNOLOGY,
K. S. R. KALVI NAGAR,
TIRUCHENGODE-637 215,
NAMAKKAL DL. TAMIL NADU.

EEE/HOD

K S R INSTITUTE FOR ENGINEERING AND TECHNOLOGY, TIRUCHENGODE - 637 215

EXAMINATION CONTROL OFFICE

INTERNAL ASSESSMENT TEST - II

I YEAR - INTERNAL HALL INVIGILATION DUTY CHART

EXAM TIMING : 11.00 AM TO 12.40 PM

DATE	HALL No.	MIC-201	MIC-202	MIC-205	MIC-206	MIC-208	MIC-306	MIC406
	DAY							
01.11.2018	THURSDAY	-	Dr.S.S.K (PHY)	R.K (ENG)	L.D.P (IT)	-	S.M (ENG)	-
02.11.2018	FRIDAY	M.S (MECH)	B.M (CHE)	K.S (MAT)	D.K (IT)	S.C.D (CHE)	-	-
03.11.2018	SATURDAY	Dr.V.D.B (PHY)	S.P (MECH)	PM (ENG)	N.P (MAT)	Dr.D.M (PHY)	-	-
08.11.2018	THURSDAY	G.M (CSE)	R.B (MECH)	R.V (MECH)	G.A (MECH)	K.S (MAT)	-	-
09.11.2018	FRIDAY	-	R.S.P (CSE)	B.M (CHE)	-	-	S.C.D (CHE)	PM (ENG)
10.11.2018	SATURDAY	S.P (MECH)	N.P (MAT)	Dr.D.M (PHY)	R.K (ENG)	Dr.V.D.B (PHY)	-	-

22/10/2018
Examination Control Office
(Coordinator)

PRINCIPAL,
K. S. R. INSTITUTE FOR
ENGINEERING AND TECHNOLOGY,
K. S. R. KALVI NAGAR,
TIRUCHENGODE-637 215,
NAMAKKAL DL, TAMIL NADU.

22/10/18
Principal

K S R INSTITUTE FOR ENGINEERING AND TECHNOLOGY, TIRUCHENGODE - 637 215

EXAMINATION CONTROL OFFICE

INTERNAL ASSESSMENT TEST - III

I YEAR - INTERNAL HALL INVIGILATION DUTY CHART

EXAM TIMING : 1.30 PM TO 4.00 PM

DATE	HALL No.	M-403	M-404	M-405	M-408	M-409	M-205	MIC-306	MIC-406
	DAY								
03.12.2018	MONDAY	K.S (MAT)	N.P (MAT)	B.M (CHE)	S.C.D (CHE)	G.A (MECH)	-	-	-
04.12.2018	TUESDAY	S.C.D (CHE)	R.K (ENG)	K.S (MAT)	S.M (ENG)	N.P (MAT)	-	-	-
05.12.2018	WEDNESDAY	D.K (IT)	S.M (ENG)	R.S.P (CSE)	PM (ENG)	B.M (CHE)	-	-	-
06.12.2018	THURSDAY	Dr.V.D.B (PHY)	Dr.D.M (PHY)	R.K (ENG)	L.D.P (IT)	S.M (ENG)	-	-	-
07.12.2018	FRIDAY	PM (ENG)	Dr.V.D.B (PHY)	Dr.D.M (PHY)	Dr.G.M (CSE)	P.S.P (IT)	-	-	-
08.12.2018	SATURDAY	-	-	-	-	-	R.B (MECH)	S.P (MECH)	G.A (MECH)

15/11/2018
Examination Control Office
(Coordinator)

15/11/2018
PRINCIPAL,
K. S. R. INSTITUTE FOR
ENGINEERING AND TECHNOLOGY,
K. S. R. KALVI NAGAR,
TIRUCHENGODE-637 215,
NAMAKKAL DI, TAMIL NADU.

15/11/2018
Principal

K S R INSTITUTE FOR ENGINEERING AND TECHNOLOGY, TIRUCHENGODE – 637 215.

Department of Electrical and Electronics Engineering

DUTY LIST

INTERNAL ASSESMENT TEST –I (IV YEAR)

ACADEMIC YEAR: 2018-19 EVEN

DATE	DAY	NAME OF THE FACULTY		
		M107	M108	M109
22.01.2019	Tuesday	DDA	KII	KMI
23.01.2019	Wednesday	PKK	KMI	TAD
24.01.2019	Thursday	AJA	CSR	PSA

Note:

- The faculty members should be present in **Power Electronics Lab (Ground Floor Main Block)** before **15mins** for collection of booklets.
- After completion of exam, submit the answer booklet in register number order to **Power Electronics Lab (Ground Floor Main Block)**.
- Faculty members should allow the students inside the exam hall after verifying **ID card and dress code**.

DEPT EXAM LEAD

PRINCIPAL

K. S. R. INSTITUTE FOR
ENGINEERING AND TECHNOLOGY,
K. S. R. KALVI NAGAR,
TIRUCHENGODE-637 215,
NAMAKKAL Dt, TAMIL NADU.

EEE/HOD

Department of Electrical and Electronics Engineering

DUTY LIST

INTERNAL ASSESMENT TEST –II (IV YEAR) &

INTERNAL ASSESMENT TEST –I (II & III YEAR)

ACADEMIC YEAR: 2018-19 EVEN

DATE	DAY	NAME OF THE FACULTY			
		M105	M106	M107	M108
06.02.2019	Wednesday	TSH	PKK	DDA	YKM
07.02.2019	Thursday	KII	PSA	CSR	RSA
08.02.2019	Friday	TAD	AJA	AR	CSK
11.02.2019	Monday-FN	PDI	KMI		
11.02.2019	Monday-AN	PSA	RSA		
12.02.2019	Tuesday	AMS	TAD		

Note:

- The faculty members should be present in **Power Electronics Lab (Ground Floor Main Block)** before **15mins** for collection of booklets.
- After completion of exam, submit the answer booklet in register number order to **Power Electronics Lab (Ground Floor Main Block)**.
- Faculty members should allow the students inside the exam hall after verifying **ID card and dress code**.

DEPT EXAM LEAD

PRINCIPAL,
K. S. R. INSTITUTE FOR
ENGINEERING AND TECHNOLOGY,
K. S. R. KALVI NAGAR,
TIRUCHENGODE-637 215,
NAMAKKAL DL TAMIL NADU.

EEE/HOD

K S R INSTITUTE FOR ENGINEERING AND TECHNOLOGY, TIRUCHENGODE - 637 215

EXAMINATION CONTROL OFFICE

INTERNAL ASSESSMENT TEST - I

I YEAR - INTERNAL HALL INVIGILATION DUTY CHART

EXAM TIMING : 11.00 AM TO 12.30 PM

DATE	HALL No.	M-403	M-404	M-405	M-409
	DAY				
28.02.2019	THURSDAY	G.A (MECH)	B.M (CHE)	Dr.D.M (PHY)	P.M (ENG)
01.03.2019	FRIDAY	S.M (ENG)	Dr.A.M (EEE)	R.D (CSE)	K.V (ECE)
02.03.2019	SATURDAY	P.K.K (EEE)	Dr.V.D.B (PHY)	P.S.A (EEE)	C.S.K (EEE)
04.03.2019	MONDAY	S.A (CHE)	Dr.S.S.K (PHY)	Dr.V.D.B (PHY)	Dr.D.M (PHY)
05.03.2019	TUESDAY	R.P (ECE)	T.A (EEE)	V.S (MECH)	L.P.D (IT)
06.03.2019	WEDNESDAY	R.K (ENG)	L.D.P (IT)	P.M (ENG)	S.M (ENG)

Examination Control Office
(Coordinator)

PRINCIPAL,
K. S. R. INSTITUTE FOR
ENGINEERING AND TECHNOLOGY,
K. S. R. KALVI NAGAR,
TIRUCHENGODE-637 215,
NAMAKKAL DI, TAMIL NADU.

Principal

Department of Electrical and Electronics Engineering

DUTY LIST

INTERNAL ASSESMENT TEST –III (IV YEAR) &

INTERNAL ASSESMENT TEST –II (II & III YEAR)

ACADEMIC YEAR: 2018-19 EVEN

DATE	DAY	NAME OF THE FACULTY			
		M105	M106	M107	M108
25.02.2019	Monday	TSH	PKK	CSR	TAD
26.02.2019	Tuesday	AMS	KMI	CSK	RSA
27.02.2019	Wednesday	AR	PDI	RSA	YKM
28.02.2019	Thursday	TSH	KMI		
01.03.2019	Friday	AMS	PSA		
02.03.2019	Saturday	YKM	CSR		

Note:

- The faculty members should be present in **Power Electronics Lab (Ground Floor Main Block)** before **15mins** for collection of booklets.
- After completion of exam, submit the answer booklet in register number order to **Power Electronics Lab (Ground Floor Main Block)**.
- Faculty members should allow the students inside the exam hall after verifying **ID card and dress code**.

DEPT EXAM LEAD

PRINCIPAL
K. S. R. INSTITUTE FOR
ENGINEERING AND TECHNOLOGY,
K. S. R. KALVINAGAR,
TIRUCHENGODE 637 215,
KARNATAKA, INDIA 576004.

EEE/HOD

Department of Electrical and Electronics Engineering

DUTY LIST

INTERNAL ASSESMENT TEST –III (II & III YEAR) &

MODEL EXAMINATION (IV YEAR)

ACADEMIC YEAR: 2018-19 EVEN

DATE	DAY	NAME OF THE FACULTY			
		M105	M106	M107	M108
15.03.2019	Friday	PDI	CSK		
16.03.2019	Saturday	PSA	YKM		
18.03.2019	Monday	YKM	AR		
19.03.2019	Tuesday	TSH	CSK	RSA	KMI
20.03.2019	Wednesday	PKK	AMS		
21.03.2019	Thursday	TSH	TAD		
22.03.2019	Friday			CSR	KMI
26.03.2019	Tuesday			RSA	CSR

Note:

- The faculty members should be present in **Power Electronics Lab (Ground Floor Main Block)** before **15mins** for collection of booklets.
- After completion of exam, submit the answer booklet in register number order to **Power Electronics Lab (Ground Floor Main Block)**.
- Faculty members should allow the students inside the exam hall after verifying **ID card and dress code**.

DEPT EXAM LEAD

PRINCIPAL,
K. S. R. INSTITUTE FOR
ENGINEERING AND TECHNOLOGY,
K. S. R. KALVI NAGAR,
TIRUCHENGODE-637 215,
NAMAKKAL DISTRICT, TAMIL NADU.

EEE/HOD

K S R INSTITUTE FOR ENGINEERING AND TECHNOLOGY, TIRUCHENGODE - 637 215

EXAMINATION CONTROL OFFICE

INTERNAL ASSESSMENT TEST - II

I YEAR - INTERNAL HALL INVIGILATION DUTY CHART

EXAM TIMING : 1.00 PM TO 4.00 PM

DATE	HALL No.	M-403	M-404	M-405	M-409
	DAY				
22.03.2019	FRIDAY	B.M (CHE)	Dr.V.D.B (PHY)	L.P.D (IT)	S.A (CHE)
23.03.2019	SATURDAY	C.S.K (EEE)	V.S (MECH)	P.M (ENG)	R.P (ECE)
25.03.2019	MONDAY	L.D.P (IT)	Dr.S.S.K (PHY)	Dr.D.M (PHY)	G.A (MECH)
26.03.2019	TUESDAY	S.M (ENG)	R.D (CSE)	P.K.K (EEE)	T.A (EEE)
27.03.2019	WEDNESDAY	Dr.V.D.B (PHY)	P.S.A (EEE)	K.V (ECE)	Dr.A.M (EEE)
28.03.2019	THURSDAY	R.K (ENG)	B.M (CHE)	S.M (ENG)	Dr.D.M (PHY)

Examination Control Office
(Coordinator)

PRINCIPAL
K. S. R. INSTITUTE FOR
ENGINEERING AND TECHNOLOGY,
K. S. R. KALVI NAGAR,
TIRUCHENGODE-637 215,
NAMAKKUL DI, TAMIL NADU.

Principal

K S R INSTITUTE FOR ENGINEERING AND TECHNOLOGY, TIRUCHENGODE - 637 215

EXAMINATION CONTROL OFFICE

INTERNAL ASSESSMENT TEST - III

I YEAR - INTERNAL HALL INVIGILATION DUTY CHART

EXAM TIMING : 1.00 PM TO 4.00 PM

DATE	HALL No.	M-403	M-404	M-405	M-409
	DAY				
11.04.2019	THURSDAY	P.M (ENG)	R.P (ECE)	R.D (CSE)	B.M (CHE)
12.04.2019	FRIDAY	K.V (ECE)	S.A (CHE)	P.S.A (EEE)	G.K (MAT)
13.04.2019	SATURDAY	Dr.V.D.B (PHY)	L.D.P (IT)	Dr.D.M (PHY)	R.K (ENG)
15.04.2019	MONDAY	P.K.K (EEE)	G.A (MECH)	C.S.K (EEE)	Dr.S.S.K (PHY)
16.04.2019	TUESDAY	V.S (MECH)	Dr.V.D.B (PHY)	Dr.A.M (EEE)	S.M (ENG)
18.04.2019	THURSDAY	T.A (EEE)	Dr.D.M (PHY)	L.P.D (IT)	B.M (CHE)

11/4/2019
Examination Control Office
(Coordinator)

PRINCIPAL
K S R INSTITUTE FOR
ENGINEERING AND TECHNOLOGY,
K. S. R. KALVI NAGAR,
TIRUCHENGODE-637 215,
NAMAKKAL DL TAMIL NADU.

Principal

EXAMINATION CONTROL OFFICE

INVIGILATION DUTY CHART- IAT-

Date	CSE		EEE		IT		ECE				MECH				
	M101	M102	M105	M106	M211	M215	M207	M208	M305	M312	MIC 101	MIC102	MIC 103	MIC201	MIC 202
15.07.19	B.L (ECE)	AMS (EEE)	RVK (Mech)	MS (Mech)	YKM (EEE)	P.M.S (ECE)	KVS (Mech)	KG (Mech)	SSR (Maths)	NLM (MAT)	PPK (ECE)	PC (Mech)	KG (IT)	V.P.K (ECE)	S.P.L (ECE)
16.07.19	V.P.K (ECE)	BVK (ECE)	SRL (Mech)	SMV (Mech)	PS (ECE)	K.V (ECE)	KG (Mech)	SR (Mech)	CSR (EEE)	VG (CSE)	SS (Mat)	RVK (Mech)	PKK (EEE)	P.M.S (ECE)	T.S (ECE)
17.07.19	W.D.P (ECE)	DK (CSE)	AP (Mech)	SR (Mech)	MUK (ECE)	PSA (EEE)	KG (Mech)	SRL (Mech)	LDP (IT)	VS (CSE)	MJN (CSE)	JM (Mech)	KGL (IT)	M.V.M (ECE)	B.V.K (ECE)
18.07.19	D.B.K (IT)	AMS (EEE)	SPS (Mech)	MS (Mech)	RSA (EEE)	T.S (ECE)	KVS (Mech)	SB (Mech)	KG (IT)	RV (CSE)	VP (CSE)	JM (Mech)	LM (Math)	S.P.L (ECE)	M.U.K (ECE)
19.07.19	J.D (ECE)	TSH (EEE)	SRL (Mech)	MS (Mech)	YKM (EEE)	A.R (ECE)	MVS (Mech)	MVS (Mech)	SAP (IT)	VM (ECE)	VS (CSE)	JM (Mech)	KGL (IT)	P.J (ECE)	P.S (ECE)
20.07.19	W.D.P (ECE)	CSK (EEE)	SB (Mech)	SMV (Mech)	PKK (EEE)	A.R (ECE)	GA (Mech)	AM (Mech)	SAP (IT)	VG (CSE)	RG (CSE)	JM (MATH S)	BKS (IT)	B.L (ECE)	

Note:

- The exam coordinators are asked to keep the answer booklet in the respective exam hall.
- The faculty members should be present in respective exam hall at 10.50PM and exam duration is 1.30 hours.
- After completion of exam, submit the answer sheet in register number order to respective department exam centre

Exams lead

PRINCIPAL
K. S. R. INSTITUTE FOR
ENGINEERING AND TECHNOLOGY,
K. S. R. KALVI NAGAR,
TIRUCHENGODE-637 215,
NAMAKKAL DL, TAMIL NADU.

Principal

K S R INSTITUTE FOR ENGINEERING AND TECHNOLOGY -TIRUCHENGODE - 637 215

EXAMINATION CONTROL OFFICE

IAT 2 -INVIGILATION DUTY CHART -

Date	CSE		EEE		IT		ECE				MECH				
	M101	M102	M105	M106	M211	M215	M207	M208	M305	M312	MIC 101	MIC102	MIC 103	MIC201	MIC 202
26.08.19	KVS (Mech)	KG (Mech)	RVK (Mech)	MS (Mech)	S.P.L (ECE)	V.P.K (ECE)	KG (IT)	SSR (Maths)	PPK (ECE)	PC (Mech)	NLM (MAT)	CSK (EEE)	RSA (EEE)	P.M.S (ECE)	B.I. (ECE)
27.08.19	KG (Mech)	SR (Mech)	SRL (Mech)	SMV (Mech)	T.M (ECE)	P.M.S (ECE)	PKK (EEE)	CSR (EEE)	SS (Mat)	RVK (Mech)	AR (ECE)	BVK (ECE)	PS (ECE)	K.V (ECE)	V.P.K (ECE)
28.08.19	GA (Mech)	SRL (Mech)	AP (Mech)	SR (Mech)	B.V.K (ECE)	M.V.M (ECE)	KGL (IT)	LDP (IT)	MJN (CSE)	JM (Mech)	VS (CSE)	DK (CSE)	MUK (ECE)	P.S.A (EEE)	V.S (ECE)
29.08.19	KVS (Mech)	SB (Mech)	SPS (Mech)	MS (Mech)	M.U.K (ECE)	S.P.L (ECE)	LM (Math)	KG (IT)	VP (CSE)	JM (Mech)	RV (CSE)	AMS (EEE)	TAD (EEE)	J.D (ECE)	D.B.K (IT)
30.08.19	KG (Mech)	MVS (Mech)	SRL (Mech)	SBK (Mech)	P.S (ECE)	P.J (ECE)	KGL (IT)	SAP (IT)	VS (CSE)	JM (Mech)	VM (ECE)	KMI (EEE)	YKM (EEE)	A.R (ECE)	J.D (ECE)
31.08.19	MVS (Mech)	AM (Mech)	SB (Mech)	SMV (Mech)	W.D.P (ECE)	B.L (ECE)	BKS (IT)	SAP (IT)	RG (CSE)	R.K (MATHS)	VG (CSE)	TSH (EEE)	PKK (EEE)	T.S (ECE)	

Note:

- The exam coordinators are asked to keep the answer booklet in the respective exam hall.
- The faculty members should be present in respective exam hall at 12.50PM and exam duration is 3 hours.
- After completion of exam, submit the answer sheet in register number order to respective department exam centre

Exams lead
22/8/19

PRINCIPAL
K. S. R. INSTITUTE FOR
ENGINEERING AND TECHNOLOGY,
K. S. R. KALVI NAGAR,
TIRUCHENGODE-637 215,
TAMIL NADU.

Principal

K S R INSTITUTE FOR ENGINEERING AND TECHNOLOGY, TIRUCHENGODE - 637 215

EXAMINATION CONTROL OFFICE

INTERNAL ASSESSMENT TEST - I

I YEAR - INTERNAL HALL INVIGILATION DUTY CHART

EXAM TIMING : 11.00 AM TO 12.30 PM

DATE	HALL No.	M-107	M-108	M-109	M-110	M-205
	DAY					
03.09.2019	TUESDAY	PM (ENG)	G.A (MECH)	S.M (ENG)	R.K (MAT)	G.K (MAT)
04.09.2019	WEDNESDAY	G.K (MAT)	P.C (MECH)	R.K (MAT)	S.B (MECH)	D.M (PHY)
05.09.2019	THURSDAY	Dr.V.D.B (PHY)	S.C.D (CHE)	Dr.D.M (PHY)	S.A (CHE)	S.P (MECH)
06.09.2019	FRIDAY	R.S.P (CSE)	L.P.D (IT)	P.S.P (IT)	A.P (MECH)	P.M (ENG)
07.09.2019	SATURDAY	Dr.D.M (PHY)	B.M (CHE)	R.S.P (CSE)	S.C.D (CHE)	L.D.P (IT)
DATE	HALL No.	MIC-305	MIC-306	MIC-406A	MIC-406 B	M-205
	DAY					
09.09.2019	MONDAY	S.M (ENG)	R.K (MAT)	Dr.V.D.B (PHY)	S.A (CHE)	P.M (ENG)

21/9/2019
Examination Control Office
(Coordinator)

PRINCIPAL
K. S. R. INSTITUTE FOR
ENGINEERING AND TECHNOLOGY,
K. S. R. KALVI NAGAR,
TIRUCHENGODE-637 215,
NAMAKKAL DISTRICT, TAMIL NADU.

Principal

K S R INSTITUTE FOR ENGINEERING AND TECHNOLOGY -TIRUCHENGODE - 637 215

EXAMINATION CONTROL OFFICE
INVIGILATION DUTY CHART - IAT 3

20.09.19

Date	CSE			EEE		IT		ECE			MECH				
	M101	M102	M103	M105	M106	M211	M215	M207	M208	M305	MIC 101	MIC102	MIC 103	MIC201	MIC 202
24.09.19 FN	SB (Mech)	V.P.K (ECE)	W.D.P (ECE)	RS (EEE)	NK (MAT)	DK (CSE)	TAD (EEE)	PC (MECH)	RVK (MECH)	NLM (MAT)	KG (IT)	BKS (IT)	PPK (ECE)	GPR (CSE)	J.D (ECE)
25.09.19 AN	AP (MECH)	B.V.K (ECE)	P.M.S (ECE)	RVS (MECH)	SPS (MECH)	TAD (EEE)	CSR (EEE)	KG (MECH)	MVS (MECH)	RV (CSE)	BVK (ECE)	RS (ECE)	SS (MA)	MVM (ECE)	T.S (ECE)
27.09.19 FN	AM (MECH)	P.S.A (EEE)	V.S (ECE)	SMV (MECH)	MS (MECH)	CSK (EEE)	MUK (ECE)	SBK (MECH)	GA (MECH)	VS (CSE)	KGL (IT)	KS (MAT)	MJN (CSE)	VP (CSE)	S.P.J. (ECE)
30.09.19 AN	SRL (MECH)	K.V (ECE)	D.B.K (IT)	RVK (MECH)	SB (MECH)	PSA (EEE)	AMS (EEE)	KG (MECH)	SMV (MECH)	AR (ECE)	RK (Math)	KG (IT)	VP (CSE)	VG (CSE)	M.V.M (ECE)
03.10.19 FN	KV (MECH)	P.J (ECE)	T.M (ECE)	JM (MECH)	SRL (MECH)	YKM (EEE)	KMI (EEE)	MVS (MECH)	AM (MECH)	VG (CSE)	KGL (IT)	SAP (IT)	VS (CSE)	GPR (CSE)	B.L (ECE)
04.10.19 AN		A.R (ECE)	R.K (MAT)	KG (MECH)	MVS (MECH)	PKK (EEE)	TSH (EEE)	JM (MECH)	SR (MECH)	RG (CSE)	LDP (IT)	SAP (IT)	RV (CSE)	M.U.K (ECE)	

Note:

- The exam coordinators are asked to keep the answer booklet in the respective exam hall.
- The faculty members should be present in respective exam hall at 12.50PM ^{9.20 AM} and exam duration is 3 hours.
- After completion of exam, submit the answer sheet in register number order to respective department exam centre

FN : 9.20 AM

AN : 12.50 PM

Exams lead

PRINCIPAL
K. S. R. INSTITUTE FOR
ENGINEERING AND TECHNOLOGY,
K. S. R. KALVI NAGAR,
TIRUCHENGODE-637 215,
AKKAL DI, TAMIL NADU.

Principal

K S R INSTITUTE FOR ENGINEERING AND TECHNOLOGY, TIRUCHENGODE - 637 215

EXAMINATION CONTROL OFFICE

INTERNAL ASSESSMENT TEST - II

I YEAR - INTERNAL HALL INVIGILATOR DUTY CHART

DATE	HALL No.	FORENOON DUTY 10.00 AM TO 1.00 PM			AFTERNOON DUTY 1.00 PM TO 4.00 PM		
		MIC-101	MIC-102	MIC-103	MIC-101	MIC-102	MIC-103
14.10.2019	THURSDAY	R.K (MAT)	Dr.V.D.B (PHY)	S.C.D (CHE)	R.S.P (CSE)	L.P.D (IT)	G.A (MECH)
15.10.2019	FRIDAY	P.M (ENG)	Dr.D.M (PHY)	P.C (MECH)	P.S.P (IT)	Dr.V.D.B (PHY)	S.A (CHE)
16.10.2019	THURSDAY	G.K (MAT)	L.D.P (IT)	B.M (CHE)	R.K (MAT)	S.M (ENG)	S.B (MECH)
17.10.2019	FRIDAY	R.S.P (CSE)	P.M (ENG)	S.P (MECH)	G.K (MAT)	Dr.D.M (PHY)	A.P (MECH)
18.10.2019	SATURDAY	S.M (ENG)	Dr.V.D.B (PHY)	G.A (MECH)	P.M (ENG)	R.K (MAT)	S.C.D (CHE)
DATE	HALL No.	MIC-305	MIC-306	MIC-406A	MIC-305	MIC-306	MIC-406A
	DAY						
19.10.2019	WEDNESDAY	L.P.D (IT)	S.A (CHE)	G.K (MAT)	S.M (ENG)	Dr.D.M (PHY)	B.M (CHE)

Wol
3/10/2019
Examination Control Office
(Coordinator)

PRINCIPAL
K. S. R. INSTITUTE FOR
ENGINEERING AND TECHNOLOGY,
K. S. R. KALVI NAGAR,
TIRUCHENGODE-637 215,
NAMAKKAL DISTRICT, TAMIL NADU.

20/10/19
Principal

K S R INSTITUTE FOR ENGINEERING AND TECHNOLOGY, TIRUCHENGODE - 637 215

EXAMINATION CONTROL OFFICE

INTERNAL ASSESSMENT TEST - III

I YEAR - INTERNAL HALL INVIGILATOR DUTY CHART

DATE	HALL No.	FORENOON DUTY 10.00 AM TO 1.00 PM			AFTERNOON DUTY 1.00 PM TO 4.00 PM		
		MIC-101	MIC-102	MIC-103	MIC-101	MIC-102	MIC-103
14.11.2019	THURSDAY	R.K (MAT)	Dr.V.D.B (PHY)	S.C.D (CHE)	R.S.P (CSE)	L.P.D (IT)	G.A (MECH)
15.11.2019	FRIDAY	P.M (ENG)	Dr.D.M (PHY)	P.C (MECH)	P.S.P (IT)	Dr.V.D.B (PHY)	S.A (CHE)
16.11.2019	SATURDAY	G.K (MAT)	L.D.P (IT)	B.M (CHE)	R.K (MAT)	S.M (ENG)	S.B (MECH)
18.11.2019	MONDAY	R.S.P (CSE)	P.M (ENG)	S.P (MECH)	G.K (MAT)	Dr.D.M (PHY)	A.P (MECH)
19.11.2019	TUESDAY	S.M (ENG)	Dr.V.D.B (PHY)	G.A (MECH)	P.M (ENG)	R.K (MAT)	S.C.D (CHE)
DATE	HALL No.	MIC-305	MIC-306	MIC-406A	MIC-305	MIC-306	MIC-406A
20.11.2019	WEDNESDAY	L.P.D (IT)	S.A (CHE)	G.K (MAT)	S.M (ENG)	Dr.D.M (PHY)	B.M (CHE)

20/11/2019
Examination Control Office
(Coordinator)

PRINCIPAL
K. S. R. INSTITUTE FOR
ENGINEERING AND TECHNOLOGY,
K. S. R. KALVI NAGAR,
TIRUCHENGODE-637 215,
NAMAKKAL DISTRICT

Principal

EXAMINATION CONTROL OFFICE

INVIGILATION DUTY CHART - IAT 1

(TIMING: 1.00PM -4.00PM)

21.01.2020

Date	CSE		EEE		IT		ECE				MECH			
	M101	M102	M104	M105	M211	M215	M207	M208	M305	M312	MIC 205	MIC 206	MIC 207	MIC 208
27.01.20 AN	VS (ECE)	TM (ECE)	GA (MECH)	RVK (MECH)	JD (ECE)	PC (MECH)	AP (MECH)	BKS (IT)	-	SS (MAT)	NLM (MAT)	RV (CSE)	TAD (EEE)	SV (EEE)
28.01.20 AN	BVK (ECE)	VS (ECE)	GA (MECH)	SMV (MECH)	MVM (ECE)	KVS (MECH)	SBK (MECH)	BM (CHE)	-	KG (IT)	RSP (CSE)	MJN (CSE)	AMS (EEE)	CSR (EEE)
29.01.20 AN	VPK (ECE)	SPL (ECE)	SRL (MECH)	SB (MECH)	JD (ECE)	MVM (ECE)	SPS (MECH)	SR (MAT)	PK (IT)	KGL (IT)	VG (CSE)	VP (CSE)	NLM (MAT)	YKM (EEE)
30.01.20 AN	PMS (ECE)	MUK (ECE)	SR (MECH)	SRL (MECH)	TS (ECE)	WDP (ECE)	SPS (MECH)	JM (MECH)	BKS (IT)	SSR (IT)	S.V (CSE)	P.V (CSE)	KMI (EEE)	RSA (EEE)
31.01.20 AN	SPL (ECE)	PS (ECE)	SB (MECH)	AP (MECH)	PJ (ECE)	PMS (ECE)	SMV (MECH)	KV (MECH)	KGL (IT)	PSPK (IT)	VS (CSE)	GPR (CSE)	TSH (EEE)	CSK (EEE)
01.02.20 AN	PJ (ECE)	PPK (ECE)	SMV (MECH)	-	BM (ECE)	BVK (ECE)	SRL (MECH)	JM (MECH)	KG (IT)	MSK (IT)	RSP (CSE)	RV (CSE)	PSA (EEE)	SBK (MECH)

▲ Note:

- ❖ The exam coordinators are asked to keep the answer booklet in the respective exam hall.
- ❖ The faculty members should be present in respective exam hall at 12.50PM and exam duration is 3 hours.
- ❖ After completion of exam, submit the answer booklet in register number order to respective department exam centre

Exam Head

21/01/2020

PRINCIPAL,
K. S. R. INSTITUTE FOR
ENGINEERING AND TECHNOLOGY,
K. S. R. KALVI NAGAR,
TIRUCHENGODE-637 215.
NAMBAKKAL DI. TAMIL NADU.

Principal

EXAMINATION CONTROL OFFICE

INVIGILATION DUTY CHART - IAT 2

(TIMING: 1.00PM -4.00PM)

26.02.2020

Date	CSE		EEE		IT		ECE			MECH			
	M101	M102	M105	M106	M211	M215	M207	M208	M312	MIC 101	MIC 102	MIC 103	MIC 201
28.02.20 AN	G A (MECH)	J M (MECH)	SRL (MECH)	SBK (MECH)	CSK (EEE)	PJ (ECE)	PV (CSE)	SV (EEE)	MJN (CSE)	KGL (IT)	MSK (IT)	VS (ECE)	JD (ECE)
02.03.20 AN	RVK (MECH)	SPS (MECH)	KG (MECH)	JM (MECH)	KMI (EEE)	VPK (ECE)	SV (CSE)	TSH (EEE)	NLM (MAT)	SSR (IT)	PSPK (IT)	PPK (ECE)	BM (CHEM)
03.03.20 AN	SBK (MECH)	SR (MECH)	KG (MECH)	AP (MECH)	PSA (EEE)	TM (ECE)	VP (CSE)	NLI (MAT)	VG (CSE)	PK (IT)	SSR (IT)	PMS (ECE)	TS (ECE)
04.03.20 AN	SRL (MECH)	G A (MECH)	KVS (MECH)	SR (MECH)	YKM (EEE)	PMS (ECE)	RSP (CSE)	RSA (EEE)	GPR (CSE)	SS (MATH S)	KG (IT)	MUK (ECE)	SPL (ECE)
05.03.20 AN	SMV (MECH)	SB (MECH)	RVK (MECH)	AP (MECH)	KMI (EEE)	MVM (ECE)	SV (CSE)	CSR (EEE)	VS (CSE)	BM (CHEM)	PK (IT)	BVK (ECE)	BL (ECE)
06.03.20 AN	SR (MATH)	SMV (MECH)	PC (MECH)		AMS (EEE)	PJ (ECE)	GPR (CSE)	SB (MEC)	RV (CSE)	PSPK (IT)	BKS (IT)	MVM (ECE)	WDP (ECE)

Note:

- ❖ The exam coordinators are asked to keep the answer booklet in the respective exam hall.
- ❖ The faculty members should be present in respective exam hall at 12.50PM and exam duration is 3 hours.
- ❖ After completion of exam, submit the answer booklet in register number order to respective department exam centre.

Exam Head

PRINCIPAL
K. S. R. INSTITUTE FOR
ENGINEERING AND TECHNOLOGY,
K. S. R. KALVI NAGAR,
TIRUCHENGODE-637 215,
TAMIL NADU.

Principal

K S R INSTITUTE FOR ENGINEERING AND TECHNOLOGY, TIRUCHENGODE - 637 215

EXAMINATION CONTROL OFFICE

INTERNAL ASSESSMENT TEST - II

I YEAR - INTERNAL HALL INVIGILATION DUTY CHART

EXAM TIMING : 1.00 PM TO 4.00 PM

DATE	HALL No.	M-403	M-404	M-405	M-408	M-409
	DAY					
20.03.2020	FRIDAY	T.A (EEE)	S.C.D (CHE)	Dr.V.D.B (PHY)	L.D.P (IT)	K.V (ECE)
21.03.2020	SATURDAY	P.M (ENG)	R.K (MAT)	S.A (CHE)	R.S (EEE)	Dr.R.M (MECH)
23.03.2020	MONDAY	K.V (ECE)	M.A.S (EEE)	S.M (ENG)	R.K (MAT)	V.S (CSE)
24.04.2020	TUESDAY	Dr.D.M (PHY)	P.M (ENG)	R.K (MAT)	Dr.V.D.B (PHY)	S.M (ENG)
26.04.2020	THURSDAY	P.M (ENG)	Dr.D.M (PHY)	R.K (MAT)	G.K (MAT)	Dr.A.M (EEE)
27.04.2020	FRIDAY	A.M (MECH)	C.S (EEE)	Dr.V.D.B (PHY)	S.A (CHE)	M.D (IT)

W.S. 2/13/2020
Examination Control Office
(Coordinator)

[Signature]
PRINCIPAL
K. S. R. INSTITUTE FOR
ENGINEERING AND TECHNOLOGY,
K. S. R. KALVI NAGAR,
TIRUCHENGODE-637 215,
NAMBARKAL DE, TAMIL NADU.

[Signature]
Principal

K S R INSTITUTE FOR ENGINEERING AND TECHNOLOGY, TIRUCHENGODE-637215
DEPARTMENT OF ELECTRICAL AND ELECTRONICS ENGINEERING
SEATING ARRANGEMENT
ODD SEMESTER 2018-19

HALL NO MI04

YEAR	COLUMN 1 (Window Side)		COLUMN 2		COLUMN 3		COLUMN 4		COLUMN 5 (Door Side)	
	II EEE	IV A YR EEE	II EEE	IV YR EEE A	II EEE	IV YR EEE A	II EEE	IV YR EEE A	II EEE	IV YR EEE A
ROW 1	731617105001	731615105001	731617105007	731615105007	731617105012	731615105012	731617105017	731615105017	731617105022	731615105023
ROW 2	731617105002	731615105002	731617105008	731615105008	731617105013	731615105013	731617105018	731615105018	731617105023	731615105024
ROW 3	731617105003	731615105003	731617105009	731615105009	731617105014	731615105014	731617105019	731615105019	731617105024	731615105025
ROW 4	731617105004	731615105004	731617105010	731615105010	731617105015	731615105015	731617105020	731615105020	731617105025	731615105026
ROW 5	731617105005	731615105005	731617105011	731615105011	731617105016	731615105016	731617105021	731615105021	731617105027	731615105027

II YR EEE	IV A YR EEE	TOTAL
25	25	50

 PRINCIPAL,
 K. S. R. INSTITUTE FOR
 ENGINEERING AND TECHNOLOGY,
 K. S. R. KALVI NAGAR,
 TIRUCHENGODE-637 215,
 NAMAKKAL DL TAMIL NADU.

K S R INSTITUTE FOR ENGINEERING AND TECHNOLOGY, TIRUCHENGODE-637215
DEPARTMENT OF ELECTRICAL AND ELECTRONICS ENGINEERING
SEATING ARRANGEMENT
ODD SEMESTER 2018-19

HALL NO M105

YEAR	COLUMN 1 (Window Side)		COLUMN 2		COLUMN 3		COLUMN 4		COLUMN 5 (Door Side)	
	II YR EEE	IV YR EEE A	II EEE	IV YR EEE A	II EEE	IV YR EEE A	II EEE	IV YR EEE A	II EEE	IV YR EEE A & B
ROW 1	731617105028	731615105029	731617105034	731615105034	731617105040	731615105039	731617105045	731615105044	731617105050	731615105501
ROW 2	731617105030	731615105030	731617105035	731615105035	731617105041	731615105040	731617105046	731615105301	731617105052	731615105045
ROW 3	731617105031	731615105031	731617105036	731615105036	731617105042	731615105041	731617105047	731615105302	731617105053	731615105046
ROW 4	731617105032	731615105032	731617105037	731615105037	731617105043	731615105042	731617105048	731615105303	731617105054	731615105047
ROW 5	731617105033	731615105033	731617105038	731615105038	731617105044	731615105043	731617105049	731615105701	731617105055	731615105048

II YR EEE	IV YR EEE A & B	TOTAL
25	21+4	50

PRINCIPAL,
K. S. R. INSTITUTE FOR
ENGINEERING AND TECHNOLOGY,
K. S. R. KALVI NAGAR,
TIRUCHENGODE-637 215,
NAMAKKAL DI, TAMIL NADU.

K S R INSTITUTE FOR ENGINEERING AND TECHNOLOGY, TIRUCHENGODE-637215
 DEPARTMENT OF ELECTRICAL AND ELECTRONICS ENGINEERING
 SEATING ARRANGEMENT
 ODD SEMESTER 2018-19

HALL NO M106

YEAR	COLUMN 1 (Window Side)		COLUMN 2		COLUMN 3		COLUMN 4		COLUMN 5 (Door Side)	
	III YR EEE	IV B YR EEE	III YR EEE	IV B YR EEE	III YR EEE	IV B YR EEE	III YR EEE	IV B YR EEE	III YR EEE	IV B YR EEE
ROW 1	731616105002	731615105049	731616105007	731615105054	731616105013	731615105059	731616105018	731615105064	731616105023	731615105069
ROW 2	731616105003	731615105050	731616105008	731615105055	731616105014	731615105060	731616105019	731615105065	731616105024	
ROW 3	731616105004	731615105051	731616105010	731615105056	731616105015	731615105061	731616105020	731615105066	731616105025	731615105070
ROW 4	731616105005	731615105052	731616105011	731615105057	731616105016	731615105062	731616105021	731615105067	731616105026	
ROW 5	731616105006	731615105053	731616105012	731615105058	731616105017	731615105063	731616105022	731615105068	731616105027	731615105071

III YR EEE	IV B YR EEE	TOTAL
25	23	48

 PRINCIPAL,
 K. S. R. INSTITUTE FOR
 ENGINEERING AND TECHNOLOGY,
 K. S. R. KALVI NAGAR,
 TIRUCHENGODE-637 215,
 NAMAKKAL DL, TAMIL NADU.

K S R INSTITUTE FOR ENGINEERING AND TECHNOLOGY,TIRUCHENGODE-637215
DEPARTMENT OF ELECTRICAL AND ELECTRONICS ENGINEERING
SEATING ARRANGEMENT
ODD SEMESTER 2018-19

HALL NO 31197

	COLUMN 1 (Window Side)		COLUMN 2		COLUMN 3		COLUMN 4		COLUMN 5 (Door Side)	
YEAR	III YR EEE	IV B YR EEE	III YR EEE	IV B YR EEE	III YR EEE	IV B YR EEE	III YR EEE	IV B YR EEE	III YR EEE	IV B YR EEE
ROW 1	731616105028	731615105072	731616105034	731615105075	731616105039	731615105078	731616105044	731615105081	731616105302	731615105085
ROW 2	731616105029		731616105035		731616105040		731616105045		731616105303	731615105086
ROW 3	731616105030	731615105073	731616105036	731615105076	731616105041	731615105079	731616105046	731615105082	731616105304	
ROW 4	731616105032		731616105037		731616105042		731616105047		731616105305	731615105087
ROW 5	731616105033	731615105074	731616105038	731615105077	731616105043	731615105080	731616105301	731615105084	731616105306	731615105088

III YR EEE	IV B YR EEE	TOTAL
25	16	41

HOD/EEE

PRINCIPAL,
K. S. R. INSTITUTE FOR
ENGINEERING AND TECHNOLOGY,
K. S. R. KALVI NAGAR,
TIRUCHENGODE -637 215,
NAMAKKAL Dt. TAMIL NADU.

**K S R INSTITUTE FOR ENGINEERING AND TECHNOLOGY,
TIRUCHENGODE – 637 215
EXAMINATION CONTROL OFFICE
IAT III - SEATING ARRANGEMENT**

DATE: 15.11.2018

It is to inform the HODs and all Class advisor II, that in view of **Internal Assessment Test - III** the seating arrangements of the students are given below. Kindly instruct the students of your departments about the same and ask them to strictly follow it during the respective examinations.

DATE	DAY	EXAMINATION HALL NO.							
		M-403	M-404	M-405	M-408	M-409	M-205	MIC-306	MIC-406
03.12.2018	MONDAY	IT - 731618205001- 731618205020 -(20) (EP)ECE - 731618106001- 731618106020 - (20) (EM-I)	ECE - 731618106021- 731618106035 - (15) (EM-I)IT - 731618205021- 731618205037- (17) (EP)CSE - 731618104001- 731618104010- (10) (EM-I)	CSE - 731618104011- 731618104027-(17) (EM-I)MECH - 731618114001- 731618114018- (17) (EP)	CSE - 731618104028- 731618104045- (18) (EM- I)MECH - 731618114019- 731618114036- (18) (EP)	EEE - 731618105001- 731618105022- (22) (EM-I)	-----	-----	-----
04.12.2018	TUESDAY	IT - 731618205001- 731618205020 -(20) (EM- I)ECE - 731618106001- 731618106020 - (20) (EC)	ECE - 731618106021- 731618106035 - (15) (EC)IT - 731618205021- 731618205037- (17) (EM-I)CSE - 731618104001- 731618104010- (10) (EC)	CSE - 731618104011- 731618104027-(17) (EC)MECH - 731618114001- 731618114018- (17) (EM-I)	CSE - 731618104028- 731618104045- (18) (EC)MECH - 731618114019- 731618114036- (18) (EM-I)	EEE - 731618105001- 731618105022- (22) (EP)	-----	-----	-----
05.12.2018	WEDNESDAY	IT - 731618205001- 731618205020 -(20) (EC)ECE - 731618106001- 731618106020 - (20) (EP)	ECE - 731618106021- 731618106035 - (15) (EP)IT - 731618205021- 731618205037- (17) (EC)CSE - 731618104001- 731618104010- (10) (EP)	CSE - 731618104011- 731618104027-(17) (EP)MECH - 731618114001- 731618114018- (17) (EC)	CSE - 731618104028- 731618104045- (18) (EP)MECH - 731618114019- 731618114036- (18) (EC)	EEE - 731618105001- 731618105022- (22) (EC)	-----	-----	-----

PRINCIPAL,
K. S. R. INSTITUTE FOR
ENGINEERING AND TECHNOLOGY,
K. S. R. KALVI NAGAR,
TIRUCHENGODE-637 215,
TAMIL NADU.

DATE	DAY	EXAMINATION HALL NO.							
		M-403	M-404	M-405	M-408	M-409	M-205	MIC-306	MIC-406
06.12.2018	THURSDAY	ECE - 731618106001- 731618106020 - (20) (CE) IT 731618205001- 731618205020 - (20) (PSP)	ECE - 731618106021- 731618106035 - (15) (CE) IT - 731618205021- 731618205037- (17) (PSP) CSE - 731618104001- 731618104010- (10) (CE)	CSE - 731618104011- 731618104030-(20) (CE) EEE - 731618105001- 7316181050022 - (22) (PSP)	CSE - 731618104031- 731618104045- (15) (CE) MECH - 731618114001- 731618114010- (10) (CE)	MECH - 731618114011- 731618114036- (25) (CE)	-----	-----	-----
07.12.2018	FRIDAY	ECE - 731618106001- 731618106020 - (20) (PSP) IT - 731618205001- 731618205020 - (20) (CE)	ECE - 731618106021- 731618106035 - (15) (PSP) IT - 731618205021- 731618205037- (17) (CE) CSE - 731618104001- 731618104010- (10) (PSP)	CSE - 731618104011- 731618104030-(20) (PSP) EEE - 731618105001- 7316181050022 - (22) (CE)	CSE - 731618104031- 731618104045- (15) (PSP) MECH - 731618114001- 731618114010- (10) (PSP)	MECH - 731618114011- 731618114036- (25) (PSP)	-----	-----	-----
08.12.2018	SATURDAY						IT - 731618205001- 731618205037 - (37) (EG) EEE - 731618105001- 7316181050022 - (22) (EG)	CSE - 731618104001- 731618104045- (45) (EG)	ECE - 731618106001- 731618106035 - (35) (EG) MECH - 731618114001- 731618114036- (35) (EG)

PRINCIPAL,
K. S. R. INSTITUTE FOR
ENGINEERING AND TECHNOLOGY,
K. S. R. KALVI NAGAR,
TIRUCHENGODE-637 215,
NAMAKKAL DI, TAMIL NADU.

Examination Control Office
(Coordinator)

K S R INSTITUTE FOR ENGINEERING AND TECHNOLOGY, TIRUCHENGODE-637215
 DEPARTMENT OF ELECTRICAL AND ELECTRONICS ENGINEERING
 SEATING ARRANGEMENT
 EVEN SEMESTER 2018-19

HALL NO M107

	COLUMN 1 (Window Side)		COLUMN 2		COLUMN 3		COLUMN 4		COLUMN 5 (Door Side)	
YEAR		IV YR EEE A		IV YR EEE A		IV YR EEE A		IV YR EEE A		IV YR EEE A
ROW 1		731615105001		731615105008		731615105014		731615105020		731615105027
ROW 2		731615105002		731615105009		731615105015		731615105021		731615105029
ROW 3		731615105003		731615105010		731615105016		731615105023		731615105030
ROW 4		731615105004		731615105011		731615105017		731615105024		731615105031
ROW 5		731615105005		731615105012		731615105018		731615105025		731615105032
ROW 6		731615105007		731615105013		731615105019		731615105026		731615105033

IV A YR EEE	TOTAL
30	30

 PRINCIPAL
 K. S. R. INSTITUTE FOR
 ENGINEERING AND TECHNOLOGY,
 K. S. R. KALVI NAGAR,
 TIRUCHENGODE-637 215,
 KANAKKAL DE, TAMIL NADU

K S R INSTITUTE FOR ENGINEERING AND TECHNOLOGY, TIRUCHENGODE-637215
 DEPARTMENT OF ELECTRICAL AND ELECTRONICS ENGINEERING
 SEATING ARRANGEMENT
 EVEN SEMESTER 2018-19

HALL NO M108

	COLUMN 1 (Window Side)		COLUMN 2		COLUMN 3		COLUMN 4		COLUMN 5 (Door Side)	
YEAR		IV YR EEE A		IV YR EEE A		IV YR EEE A & B		IV YR EEE A		IV YR EEE A & B
ROW 1		731615105034		731615105040		731615105302		731615105047		731615105053
ROW 2		731615105035		731615105041		731615105303		731615105048		731615105054
ROW 3		731615105036		731615105042		731615105701		731615105049		731615105055
ROW 4		731615105037		731615105043		731615105501		731615105050		731615105056
ROW 5		731615105038		731615105044		731615105045		731615105051		731615105057
ROW 6		731615105039		731615105301		731615105046		731615105052		731615105058

IVYR EEE A & B	TOTAL
16+14	30

K S R INSTITUTE FOR ENGINEERING AND TECHNOLOGY, TIRUCHENGODE-637215
 DEPARTMENT OF ELECTRICAL AND ELECTRONICS ENGINEERING
 SEATING ARRANGEMENT
 EVEN SEMESTER 2018-19

HALL NO MI09

	COLUMN 1 (Window Side)		COLUMN 2		COLUMN 3		COLUMN 4		COLUMN 5 (Door Side)	
YEAR		IV B YR EEE		IV B YR EEE		IV B YR EEE		IV B YR EEE		IV B YR EEE
ROW 1		731615105059		731615105065		731615105071		731615105077		731615105084
ROW 2		731615105060		731615105066		731615105072		731615105078		731615105085
ROW 3		731615105061		731615105067		731615105073		731615105079		731615105086
ROW 4		731615105062		731615105068		731615105074		731615105080		731615105087
ROW 5		731615105063		731615105069		731615105075		731615105081		731615105088
ROW 6		731615105064		731615105070		731615105076		731615105082		-

IV B YR EEE	TOTAL
29	29

HOD/EEE



 PRINCIPAL
 K. S. R. INSTITUTE FOR
 ENGINEERING AND TECHNOLOGY,
 K. S. R. KALVINADAVAR
 TIRUCHENGODE
 NAMAKKAL DISTRICT

K S R INSTITUTE FOR ENGINEERING AND TECHNOLOGY, TIRUCHENGODE-637215
 DEPARTMENT OF ELECTRICAL AND ELECTRONICS ENGINEERING
 SEATING ARRANGEMENT
 EVEN SEMESTER 2018-19

HALL NO M105

YEAR	COLUMN 1 (Window Side)		COLUMN 2		COLUMN 3		COLUMN 4		COLUMN 5 (Door Side)	
	II EEE	IV A YR EEE	II EEE	IV YR EEE A	II EEE	IV YR EEE A	II EEE	IV YR EEE A	II EEE	IV YR EEE A
ROW 1	731617105001	731615105001	731617105008	731615105007	731617105013	731615105012	731617105018	731615105017	731617105023	731615105023
ROW 2	731617105002	731615105002	731617105009	731615105008	731617105014	731615105013	731617105019	731615105018	731617105024	731615105024
ROW 3	731617105003	731615105003	731617105010	731615105009	731617105015	731615105014	731617105020	731615105019	731617105025	731615105025
ROW 4	731617105004	731615105004	731617105011	731615105010	731617105016	731615105015	731617105021	731615105020	731617105027	731615105026
ROW 5	731617105005	731615105005	731617105012	731615105011	731617105017	731615105016	731617105022	731615105021	731617105028	731615105027

II YR EEE	IV A YR EEE	TOTAL
25	25	50



 PRINCIPAL,
 K. S. R. INSTITUTE FOR
 ENGINEERING AND TECHNOLOGY,
 K. S. R. KALVI NAGAR
 TIRUCHENGODE-637215
 NAMAKKAL Dt. Tamil Nadu

K S R INSTITUTE FOR ENGINEERING AND TECHNOLOGY, TIRUCHENGODE-637215
DEPARTMENT OF ELECTRICAL AND ELECTRONICS ENGINEERING
SEATING ARRANGEMENT
EVEN SEMESTER 2018-19

HALL NO: MI06

YEAR	COLUMN 1 (Window Side)		COLUMN 2		COLUMN 3		COLUMN 4		COLUMN 5 (Door Side)	
	II YR EEE	IV YR EEE A	II EEE	IV YR EEE A	II EEE	IV YR EEE A	II EEE	IV YR EEE A	II EEE	IV YR EEE A & B
ROW 1	731617105031	731615105029	731617105036	731615105034	731617105042	731615105039	731617105047	731615105044	731617105053	731615105501
ROW 2	731617105032	731615105030	731617105037	731615105035	731617105043	731615105040	731617105048	731615105301	731617105054	731615105045
ROW 3	731617105033	731615105031	731617105038	731615105036	731617105044	731615105041	731617105049	731615105302	731617105055	731615105046
ROW 4	731617105034	731615105032	731617105040	731615105037	731617105045	731615105042	731617105050	731615105303	-	731615105047
ROW 5	731617105035	731615105033	731617105041	731615105038	731617105046	731615105043	731617105052	731615105701	-	731615105048

II YR EEE	IV YR EEE A & B	TOTAL
23	21+4	48

PRINCIPAL,
K. S. R. INSTITUTE FOR
ENGINEERING AND TECHNOLOGY,
K. S. R. KALVI NAGAR,
TIRUCHENGODE-637 215,
NAMAKKAL DI, TAMIL NADU.

K S R INSTITUTE FOR ENGINEERING AND TECHNOLOGY, TIRUCHENGODE-637215
DEPARTMENT OF ELECTRICAL AND ELECTRONICS ENGINEERING
SEATING ARRANGEMENT
EVEN SEMESTER 2018-19

HALL NO M107

YEAR	COLUMN 1 (Window Side)		COLUMN 2		COLUMN 3		COLUMN 4		COLUMN 5 (Door Side)	
	III YR EEE	IV B YR EEE	III YR EEE	IV B YR EEE	III YR EEE	IV B YR EEE	III YR EEE	IV B YR EEE	III YR EEE	IV B YR EEE
ROW 1	731616105002	731615105049	731616105007	731615105054	731616105013	731615105059	731616105018	731615105064	731616105023	731615105069
ROW 2	731616105003	731615105050	731616105008	731615105055	731616105014	731615105060	731616105019	731615105065	731616105024	—
ROW 3	731616105004	731615105051	731616105010	731615105056	731616105015	731615105061	731616105020	731615105066	731616105025	731615105070
ROW 4	731616105005	731615105052	731616105011	731615105057	731616105016	731615105062	731616105021	731615105067	731616105026	—
ROW 5	731616105006	731615105053	731616105012	731615105058	731616105017	731615105063	731616105022	731615105068	731616105027	731615105071

III YR EEE	IV B YR EEE	TOTAL
25	23	48

 PRINCIPAL,
 K. S. R. INSTITUTE FOR
 ENGINEERING AND TECHNOLOGY,
 K. S. R. KALVI NAGAR,
 TIRUCHENGODE-637 215,
 NAMAKKAL DI, TAMIL NADU.

K S R INSTITUTE FOR ENGINEERING AND TECHNOLOGY,TIRUCHENGODE-637215
DEPARTMENT OF ELECTRICAL AND ELECTRONICS ENGINEERING
SEATING ARRANGEMENT
EVEN SEMESTER 2018-19

HALL NO M108

YEAR	COLUMN1 (Window Side)		COLUMN 2		COLUMN 3		COLUMN 4		COLUMN 5 (Door Side)	
	III YR EEE	IV B YR EEE	III YR EEE	IV B YR EEE	III YR EEE	IV B YR EEE	III YR EEE	IV B YR EEE	III YR EEE	IV B YR EEE
ROW 1	731616105028	731615105072	731616105034	731615105075	731616105039	731615105070	731616105044	731615105081	731616105303	731615105085
ROW 2	731616105029	-	731616105035	-	731616105040	-	731616105045	-	731616105304	731615105086
ROW 3	731616105030	731615105073	731616105036	731615105076	731616105041	731615105079	731616105046	731615105082	731616105305	-
ROW 4	731616105032	-	731616105037	-	731616105042	-	731616105047	-	731616105306	731615105087
ROW 5	731616105033	731615105074	731616105038	731615105077	731616105043	731615105080	731616105301	731615105084	-	731615105088

III YR EEE	IV B YR EEE	TOTAL
24	16	40

HOD/EEE

PRINCIPAL,
K. S. R. INSTITUTE FOR
ENGINEERING AND TECHNOLOGY,
K. S. R. KALVI NAGAR,
TIRUCHENGODE-637 215,
NAMAKKAL DI, TAMIL NADU.

K S R INSTITUTE FOR ENGINEERING AND TECHNOLOGY,

TIRUCHENGODE – 637 215

EXAMINATION CONTROL OFFICE

IAT I - SEATING ARRANGEMENT

DATE: 11.02.2019

DATE	DAY	M-403	M-404	M-405	M-409
28.02.2019	Thursday	731618114001- 7316181140019 (18) (Mech)	731618114020- 7316181140036 (18) (Mech)	731618106001- 731618106018 (18) (ECE)	731618106019- 731618106035 (17) (ECE)
01.03.2019	Friday	731618205001- 731618205018 (18) (IT)	731618205019- 731618205037 (19) (IT)	731618104001- 731618104018 (18) (CSE)	731618104019- 731618104042 (24) (CSE)
02.03.2019	Saturday	731618105001- 731618105007 (7) (EEE)	731618105008- 731618105015 (8) (EEE)	731618105016- 731618105022 (7) (EEE)	731617105051 (1) (EEE)
04.03.2019	Monday				
05.03.2019	Tuesday				
06.03.2019	Wednesday				

PRINCIPAL
K. S. R. INSTITUTE FOR
ENGINEERING AND TECHNOLOGY,
K. S. R. KALVI NAGAR,
TIRUCHENGODE-637 215,
NANDIKAL DE, TAMIL NADU.

12/2/2019
Examination Control Office
(Coordinator)

K S R INSTITUTE FOR ENGINEERING AND TECHNOLOGY, IRUCHENGODE 637215
DEPARTMENT OF ELECTRONICS & COMMUNICATION ENGINEERING

ACADEMIC YEAR 2019-20

IAT - Seating Arrangements

SEM: ODD

Hall No: 207

Total: 70

COLUMN 1		COLUMN 2		COLUMN 3		COLUMN 4		COLUMN 5	
II	III	II	IV	II	III	II	IV	II	III
731618106001	731617106002	731618106008	731616106001	731618106015	731617106011	731618106023	731616106008	731618106030	731617106019
731618106002	731617106003	731618106009	731616106002	731618106016	731617106012	731618106024	731616106009	731618106031	731617106020
731618106003	731617106004	731618106010	731616106003	731618106018	731617106014	731618106025	731616106010	731618106032	731617106021
731618106004	731617106006	731618106011	731616106004	731618106019	731617106015	731618106026	731616106011	731618106033	731617106022
731618106005	731617106007	731618106012	731616106005	731618106020	731617106016	731618106027	731616106012	731618106034	731617106023
731618106006	731617106008	731618106013	731616106006	731618106021	731617106017	731618106028	731616106013	731618106035	731617106024
731618106007	731617106010	731618106014	731616106007	731618106022	731617106018	731618106029	731616106014	731618106036	731617106025
				II Year -35		III Year -21		IV Year -14	

Hall No: 208

Total: 70

COLUMN 1		COLUMN 2		COLUMN 3		COLUMN 4		COLUMN 5	
II/III	IV	III	IV	III	IV	III	IV	III	IV
731618106030	731616106013	731617106033	731616106022	731617106040	731616106030	731617106048	731616106037	731617106057	731616106045
731617106027	731616106016	731617106034	731616106023	731617106041	731616106031	731617106049	731616106038	731617106058	731616106046
731617106028	731616106017	731617106035	731616106024	731617106042	731616106032	731617106050	731616106039	731617106059	731616106047
731617106029	731616106018	731617106036	731616106026	731617106043	731616106033	731617106051	731616106040	731617106060	731616106048
731617106030	731616106019	731617106037	731616106027	731617106044	731616106034	731617106052	731616106041	731617106061	731616106049
731617106031	731616106020	731617106038	731616106028	731617106046	731616106035	731617106053	731616106042	731617106062	731616106050
731617106032	731616106021	731617106039	731616106029	731617106047	731616106036	731617106054	731616106043	731617106063	731616106051
				II Year -1		III Year -34		IV Year -35	

Hall No: 312

Total: 55

COLUMN 1		COLUMN 2		COLUMN 3		COLUMN 4		COLUMN 5	
III*	IV	III	IV	III	IV	III	IV	III	IV
731617106064	731616106052	731617106071	731616106059	731617106079	731616106066	731617106087	731616106075		731616106083
731617106065	731616106053	731617106073	731616106060	731617106080	731616106067	731617106091	731616106076		731616106084
731617106066	731616106054	731617106074	731616106061	731617106081	731616106068	731617106092	731616106077		731616106085
731617106067	731616106055	731617106075	731616106062	731617106082	731616106069		731616106078		
731617106068	731616106056	731617106076	731616106063	731617106084	731616106072		731616106079		
731617106069	731616106057	731617106077	731616106064	731617106085	731616106073		731616106080		
731617106070	731616106058	731617106078	731616106065	731617106086	731616106074		731616106082		
				III Year 24		IV-31			

T.M.S.
24/9/19
EXAM CELL I/C

PRINCIPAL
K. S. R. INSTITUTE FOR
ENGINEERING AND TECHNOLOGY,
K. S. R. KALVI NAGAR,
IRUCHENGODE-637 215,
NAMAKKAL Dt, TAMIL NADU.

[Signature]
HOD 20/9/19.

K. S. R. INSTITUTE FOR ENGINEERING AND TECHNOLOGY, TIRUCHENGODE 637215
DEPARTMENT OF ELECTRONICS & COMMUNICATION ENGINEERING
I A P P, II Seating Arrangements

ACADEMIC YEAR 2019-20

SEM: EVEN

Hall No: 207

Total: 54

COLUMN 1		COLUMN 2		COLUMN 3		COLUMN 4		COLUMN 5	
<i>II</i>	<i>III-A</i>	<i>IV-A</i>	<i>II</i>	<i>III-A</i>	<i>IV-A</i>	<i>III-A</i>	<i>IV-A</i>	<i>III-A</i>	<i>IV-A</i>
73161810001	73161710002	73161610003	73161810007	73161710010	73161610006	73161710018	73161610011	73161710021	73161610016
73161810002	73161710003	73161610002	73161810008	73161710011	73161610007	73161710017	73161610012	73161710022	73161610017
73161810003	73161710004	73161610003	73161810009	73161710012	73161610008	73161710018	73161610013	73161710023	73161610018
73161810004	73161710005	73161610004	73161810010	73161710014	73161610009	73161710019	73161610014	73161710024	73161610019
73161810005	73161710006	73161610005	73161810011	73161710015	73161610010	73161710020	73161610015	73161710025	73161610020
73161810006	73161710008							73161710027	73161610021

<i>II Year -11</i>	<i>III Year -22</i>	<i>IV Year -21</i>
--------------------	---------------------	--------------------

Hall No: 208

Total: 54

COLUMN 1		COLUMN 2		COLUMN 3		COLUMN 4		COLUMN 5	
<i>II</i>	<i>III-A</i>	<i>IV-A</i>	<i>II</i>	<i>III-A</i>	<i>IV-A</i>	<i>III-A</i>	<i>IV-A</i>	<i>III-A,B</i>	<i>IV-A,B</i>
73161810012	73161710028	73161610022	73161810019	73161710034	73161610028	73161710039	73161610033	73161710045	73161610038
73161810013	73161710029	73161610023	73161810020	73161710035	73161610029	73161710040	73161610034	73161710046	73161610039
73161810014	73161710030	73161610024	73161810021	73161710036	73161610030	73161710041	73161610035	73161710047	73161610040
73161810015	73161710031	73161610025	73161810022	73161710037	73161610031	73161710042	73161610036	73161710048	73161610041
73161810016	73161710032	73161610027	73161810023	73161710038	73161610032	73161710043	73161610037	73161710049	73161610042
73161810018	73161710035							73161710050	73161610043

<i>II Year -11</i>	<i>III Year -22</i>	<i>IV Year -21</i>
--------------------	---------------------	--------------------

PRINCIPAL
K. S. R. INSTITUTE FOR
ENGINEERING AND TECHNOLOGY,
K. S. R. KALVI NAGAR,
TIRUCHENGODE-637 215,
NAMAKKAL DL TAMIL NADU

Hall No: 312

Total: 50

COLUMN 1		COLUMN 2		COLUMN 3		COLUMN 4		COLUMN 5	
<i>II</i>	<i>III-B</i>	<i>IV-B</i>	<i>II</i>	<i>III-B</i>	<i>IV-B</i>	<i>III-B</i>	<i>IV-B</i>	<i>III-B</i>	<i>IV-B</i>
73161810024	73161710051	73161610045	73161810028	73161710050	73161610050	73161710063	73161610055	73161710068	73161610060
73161810025	73161710052	73161610046	73161810029	73161710055	73161610051	73161710064	73161610056	73161710069	73161610061
73161810026	73161710055	73161610047	73161810031	73161710060	73161610052	73161710065	73161610057	73161710070	73161610062
73161810027	73161710056	73161610048	73161810032	73161710065	73161610053	73161710066	73161610058	73161710071	73161610063
73161810028	73161710057	73161610049	73161810033	73161710062	73161610054	73161710067	73161610059	73161710072	73161610064
				<i>II Year -10</i>	<i>III Year -20</i>	<i>IV Year - 20</i>			

ACADEMIC YEAR 2019-20

SEM: EVEN

Hall No: 305

Total: 38

COLUMN 1		COLUMN 2		COLUMN 3		COLUMN 4		COLUMN 5	
<i>II</i>	<i>III-B</i>	<i>IV-B</i>	<i>II</i>	<i>III-B</i>	<i>IV-B</i>	<i>III-B</i>	<i>IV-B</i>		<i>IV-B</i>
73161810034	73161710074	73161610065		73161710079	73161610072	73161710085	73161610077		73161610083
73161810035	73161710075	73161610066		73161710080	73161610073	73161710086	73161610078		73161610084
73161810036	73161710076	73161610067		73161710081	73161610074	73161710087	73161610079		73161610085
73161810037	73161710077	73161610068		73161710082	73161610075	73161710088	73161610080		73161610086
	73161710078	73161610069		73161710084	73161610076	73161710089	73161610081		
				<i>II Year -04</i>	<i>III Year -15</i>	<i>IV Year - 19</i>			

T.M.V.
B/2/2020
EXAM CELL I/C

PRINCIPAL
K. S. R. INSTITUTE FOR
ENGINEERING AND TECHNOLOGY,
K. S. R. KALVI NAGAR,
TIRUCHENGODE-637 215,
DINAKKAL DL TAMIL NADU.

HOD.
8/11/20

INTERNAL ASSESMENT TEST - III

I - YEAR SEATING ARRANGEMENT

MIC - MECHANICAL BLOCK

Time : 10.00 am to 1.00 pm

HALL No.	DEGREE / BRANCH	SUBJECT NAME	REGISTER NUMBER
MIC 101	B.E.,ECE	CE,EM-I,EP,EC,PSP	731619106001-731619106021
	B.E.,MECH	CE,EM-I,EP,EC,PSP	731619114001-731619114021
MIC 102	B.E.,ECE	CE,EM-I,EP,EC,PSP	731619106022-731619106042
	B.E.,MECH	CE,EM-I,EP,EC,PSP	731619114022-731619114035
MIC 103	B.E.,ECE	CE,EM-I,EP,EC,PSP	731619106043-731619106045
	B.E.,EEE	CE,EM-I,EP,EC,PSP	731619105001-731619105032

PRINCIPAL
K. S. R. INSTITUTE FOR
ENGINEERING AND TECHNOLOGY,
K. S. R. KALVI NAGAR,
TIRUCHENGODE-637 215,
NARAKKAL DI. TAMIL NADU.

EXAMINATION CONTROL OFFICE
(COORDINATOR)

INTERNAL ASSESMENT TEST - III

I - YEAR SEATING ARRANGEMENT

MIC - MECHANICAL BLOCK

Time : 1.00 pm to 4.00 pm

HALL No.	DEGREE / BRANCH	SUBJECT NAME	REGISTER NUMBER
MIC 101	B.E.,CSE	CE,EM-I,EP,EC,PSP	731619104001-731619104021
	B.Tech.,IT	CE,EM-I,EP,EC,PSP	731619205001-731619205021
MIC 102	B.E.,CSE	CE,EM-I,EP,EC,PSP	731619104022-731619104042
	B.Tech.,IT	CE,EM-I,EP,EC,PSP	731619205022-731619205042
MIC 103	B.E.,CSE	CE,EM-I,EP,EC,PSP	731619104043-731619104063
	B.Tech.,IT	CE,EM-I,EP,EC,PSP	731619205043-731619205063

PRINCIPAL,
K. S. R. INSTITUTE FOR
ENGINEERING AND TECHNOLOGY,
K. S. R. KALVI NAGAR,
TIRUCHENGODE-637 215,
NAMAKKAL DI, TAMIL NADU.

EXAMINATION CONTROL OFFICE
(COORDINATOR)

7316 - K S R INSTITUTE FOR ENGINEERING AND TECHNOLOGY, TIRUCHENGODE - 637215

INTERNAL ASSESMENT TEST - III

I - YEAR SEATING ARRANGEMENT

MIC - MECHANICAL BLOCK

Time : 10.00 am to 1.00 pm

HALL No.	DEGREE / BRANCH	SUBJECT NAME	REGISTER NUMBER
MIC 305	B.E.,CSE	ENGINEERING GRAPHICS	731619104001-731619104021
	B.Tech.,IT	ENGINEERING GRAPHICS	731619205001-731619205021
MIC 306	B.E.,CSE	ENGINEERING GRAPHICS	731619104022-731619104042
	B.Tech.,IT	ENGINEERING GRAPHICS	731619205022-731619205042
MIC 406A	B.E.,CSE	ENGINEERING GRAPHICS	731619104043-731619104063
	B.Tech.,IT	ENGINEERING GRAPHICS	731619205043-731619205063

PRINCIPAL,
K. S. R. INSTITUTE FOR
ENGINEERING AND TECHNOLOGY,
K. S. R. KALVI NAGAR,
TIRUCHENGODE-637 215,
NAMAKKAL Dt. TAMIL NADU.

EXAMINATION CONTROL OFFICE
(COORDINATOR)

INTERNAL ASSESMENT TEST - I

I - YEAR SEATING ARRANGEMENT

Time : 11.00 am to 12.30 pm

HALL No	DEGREE / BRANCH	REGISTER NUMBER
M403	B.E.,CSE	731619104001-731619104025
M404	B.E.,CSE	731619104026-731619104055
	B.E.,EEE	731619105001-731619105029, 731619105032
M405	B.Tech.,IT	731619205001-731619205030
	B.E.,ECE	731619106001-731619106005, 731619106007-731619106031
M408	B.Tech.,IT	731619205031-731619205060
	B.E.,ECE	731619106032-731619106033, 731619106035-731619106045
M206	B.E.,MECH	731619114001-731619114002, 731619114004-731619114035
	B.E.,CSE	731619104056-731619104058, 731619104060-731619104063
	B.Tech.,IT	731619205061-731619205063

PRINCIPAL,
K. S. R. INSTITUTE FOR
ENGINEERING AND TECHNOLOGY,
K. S. R. KALVI NAGAR,
TIRUCHENGODE-637 215,
TIRUKALAI DISTRICT, TAMIL NADU.

24/11/2020
EXAMINATION CONTROL OFFICE

K S R INSTITUTE FOR ENGINEERING AND TECHNOLOGY, TIRUCHENGODE.637215
DEPARTMENT OF ELECTRONICS & COMMUNICATION ENGINEERING
IAT-II Seating Arrangements

ACADEMIC YEAR 2019-20

SEM: ODD

Hall No: 207

Total: 54

COLUMN 1		COLUMN 2		COLUMN 3		COLUMN 4		COLUMN 5	
<i>II</i>	<i>III-A</i>	<i>IV-A</i>	<i>II</i>	<i>III-A</i>	<i>IV-A</i>	<i>III-A</i>	<i>IV-A</i>	<i>III-A</i>	<i>IV-A</i>
73161810001	73161710002	73161810001	73161810007	73161710003	73161810004	73161710009	73161810011	73161710021	73161810036
73161810002	73161710003	73161810002	73161810008	73161710011	73161810007	73161710017	73161810012	73161710022	73161810017
73161810003	73161710004	73161810003	73161810009	73161710012	73161810008	73161710018	73161810013	73161710023	73161810018
73161810004	73161710005	73161810004	73161810010	73161710014	73161810009	73161710019	73161810014	73161710024	73161810019
73161810005	73161710006	73161810005	73161810011	73161710015	73161810010	73161710020	73161810015	73161710025	73161810020
73161810006	73161710007								
								73161710027	73161810021

II Year -11 III Year -22 IV Year -21

Hall No: 208

Total: 54

COLUMN 1		COLUMN 2		COLUMN 3		COLUMN 4		COLUMN 5	
<i>II</i>	<i>III-A</i>	<i>IV-A</i>	<i>II</i>	<i>III-A</i>	<i>IV-A</i>	<i>III-A</i>	<i>IV-A</i>	<i>III-A,B</i>	<i>IV-A,B</i>
73161810012	73161710028	73161810022	73161810019	73161710034	73161810025	73161710039	73161810032	73161710045	73161810038
73161810013	73161710029	73161810023	73161810020	73161710035	73161810026	73161710040	73161810033	73161710046	73161810039
73161810014	73161710030	73161810024	73161810021	73161710036	73161810027	73161710041	73161810034	73161710047	73161810040
73161810015	73161710031	73161810025	73161810022	73161710037	73161810028	73161710042	73161810035	73161710048	73161810041
73161810016	73161710032	73161810026	73161810023	73161710038	73161810029	73161710043	73161810036	73161710049	73161810042
73161810018	73161710035							73161710051	73161810044

II Year -11 III Year -22 IV Year -21

PRINCIPAL.
K. S. R. INSTITUTE FOR
ENGINEERING AND TECHNOLOGY,
K. S. R. KALVI NAGAR,
TIRUCHENGODE - 637 215,
NAMBARKAL OL, South Arcot.

K S R INSTITUTE FOR ENGINEERING AND TECHNOLOGY TIRUCHENGODE 637215
DEPARTMENT OF ELECTRONICS & COMMUNICATION ENGINEERING

ACADEMIC YEAR 2019-20

IAT - Seating Arrangements

SEM: EVEN

Hall No: 207

COLUMN 1		COLUMN 2		COLUMN 3		COLUMN 4		COLUMN 5	
II	III	II	IV	II	III	II	IV	II	III
731618106001	731617106002	731618106008	731616106001	731618106015	731617106011	731618106023	731616106008	731618106030	731617106019
731618106002	731617106003	731618106009	731616106002	731618106016	731617106012	731618106024	731616106009	731618106031	731617106020
731618106003	731617106004	731618106010	731616106003	731618106018	731617106014	731618106025	731616106010	731618106032	731617106021
731618106004	731617106006	731618106011	731615106004	731618106019	731617106015	731618106026	731616106011	731618106033	731617106022
731618106005	731617106007	731618106012	731616106005	731618106020	731617106016	731618106027	731616106012	731618106034	731617106023
731618106006	731617106008	731618106013	731616106006	731618106021	731617106017	731618106028	731616106013	731618106035	731617106024
731618106007	731617106010	731618106014	731616106007	731618106022	731617106018	731618106029	731616106014	731618106030	731617106025

Total: 70
 II Year -35 III Year -21 IV Year -14

Hall No: 208

COLUMN 1		COLUMN 2		COLUMN 3		COLUMN 4		COLUMN 5	
II/III	IV	III	IV	III	IV	III	IV	III	IV
731618106002	731616106015	731617106003	731616106022	731617106040	731616106030	731617106048	731616106037	731617106057	731616106045
731617106027	731616106016	731617106004	731616106023	731617106041	731616106031	731617106049	731616106038	731617106058	731616106046
731617106028	731616106017	731617106005	731616106024	731617106042	731616106032	731617106050	731616106039	731617106059	731616106047
731617106029	731616106018	731617106006	731616106025	731617106043	731616106033	731617106051	731616106040	731617106060	731616106048
731617106030	731616106019	731617106007	731616106027	731617106044	731616106034	731617106052	731616106041	731617106061	731616106049
731617106031	731616106020	731617106008	731616106028	731617106046	731616106035	731617106053	731616106042	731617106062	731616106050
731617106032	731616106021	731617106009	731616106029	731617106047	731616106036	731617106054	731616106043	731617106063	731616106051

Total: 70
 II Year -1 III Year -34 IV Year -35

Hall No: 312

COLUMN 1		COLUMN 2		COLUMN 3		COLUMN 4		COLUMN 5	
III	IV	III	IV	III	IV	III	IV	III	IV
731617106084	731616106052	731617106071	731616106059	731617106079	731616106066	731617106087	731616106075		731616106083
731617106085	731616106053	731617106073	731616106060	731617106080	731616106067	731617106088	731616106076		731616106084
731617106086	731616106054	731617106074	731616106061	731617106081	731616106068	731617106089	731616106077		731616106085
731617106087	731616106055	731617106075	731616106062	731617106082	731616106069		731616106078		731616106086
731617106088	731616106056	731617106076	731616106063	731617106084	731616106072		731616106079		731616106087
731617106089	731616106057	731617106077	731616106064	731617106085	731616106073		731616106080		731616106088
731617106090	731616106058	731617106078	731616106065	731617106086	731616106074		731616106081		731616106089

III Year 24 IV-32

EXAM CELL IIC

PRINCIPAL:
 K. S. R. INSTITUTE FOR
 ENGINEERING AND TECHNOLOGY
 K. S. R. KALVI NAGAR,
 TIRUCHENGODE-637 215,
 NAMAKKAL Dt. TAMIL NADU.

[Signature]
 HOD

Reg. No.

--	--	--	--	--	--	--	--	--	--

KSR INSTITUTE FOR ENGINEERING AND TECHNOLOGY, TIRUCHENGODE- 637 215

INTERNAL ASSESSMENT TEST-III

Year/Semester	: III Year / VI Semester	Max Marks.	: 70
Branch	: MECHANICAL ENGINEERING	Duration	: 2 Hr.30 minutes
Subject Code & Title	: ME6602 & AUTOMOBILE ENGINEERING	Date & Session	: 04 .04.2018 &AN

Answer all the Questions

PART-A

(8 x 2=16)

- | | | | | |
|----|--|--|-----|----|
| 1. | Give types of stub axle. | | CO4 | K2 |
| 2. | Name the classification of braking system. | | CO4 | K2 |
| 3. | What is included angle? | | CO4 | K2 |
| 4. | Name any four types of suspension spring. | | CO4 | K2 |
| 5. | Write short notes on "LPG". | | CO5 | K1 |
| 6. | Differentiate between bio-fuel and bio-diesel. | | CO5 | K4 |
| 7. | Why alcohol is an alternate fuel for S.I engine? | | CO5 | K2 |
| 8. | What do you understand by the term hybrid vehicle? | | CO5 | K2 |

PART-B

(3 x 13=39)

- | | | | | | |
|-----------|--|--|------|-----|----|
| 9. | (a) (i) What are the functions of steering system? | | (3) | CO4 | K2 |
| | (ii) Discuss in detail working method of steering linkage system with suitable sketches. | | (10) | | K1 |
| OR | | | | | |
| 9. | (b) (i) Write the various steering geometry. | | (3) | CO4 | K1 |
| | (ii) Explain any one of the front independent suspension system with neat diagram? | | (10) | | K2 |
| 10. | (a) With relevant block diagrams, analyze the working of 4 channel 4 sensor type ABS system used in passenger cars. | | (13) | CO4 | K4 |
| OR | | | | | |
| 10. | (b) (i) What are the requirements of good breaking system? | | (6) | CO4 | K2 |
| | (ii) Draw the schematic diagram of pneumatic breaking system and explain it. | | (7) | | K1 |
| 11. | (a) Describe the construction and working of hybrid vehicle with neat sketch? | | (13) | CO5 | K1 |
| OR | | | | | |
| 11. | (b) Develop and explain the engine modifications to be undertaken in the S.I engine for Alcohols or Ethanol as alternative fuel? | | (13) | CO5 | K3 |

PART-C

(1 x 15=15)

- | | | | | | |
|-----------|--|--|-----|-----|----|
| 2. | (a) (i) What are the merits and demerits of LPG as a motor vehicle fuel? | | (8) | CO5 | K2 |
| | (ii) Write the advantages of LNG? | | (7) | | K1 |
| OR | | | | | |
| 12. | (b) (i) Explain the construction and working of the PEM fuel cell with sketch. | | (8) | CO5 | K2 |
| | (ii) Explain any one method of hydrogen production. | | (7) | | |

CO4	Discuss the terminology, working of steering, braking and suspension systems.
CO5	Explain the different alternative energy resources used in automobile industry.

K1: Remembering K2: Understanding K3: Applying K4: Analyzing K5: Evaluating K6: Creating

% of Remembering	% of Understanding	% of Application and higher order Abilities (K3+K4+K5+K6)	Total
33.87	43.55	22.58	100%



 PRINCIPAL

semester	III Year/VI Semester	Max Marks	70
Code & Title	MECHANICAL ENGINEERING ME66602 AUTOMOBILE ENGINEERING	Date & Session	04.04.2018 & A/N

PART-A

- types of stub axle. (2)
- reversed Elliot, Lamoine and Reversed Lamoine (2)
- the classification of braking system. (2)
- braking system in Automobile;
- applications – Foot, Hand brake
- Method of power – Mechanical, Hydraulic, Vacuum, Electrical and Air brake.
- method of operations – Manual, Servo and Power operation brake.
- construction – Drum type and Disc type brake.
- included angle? (2)
- ded Angle is calculated by adding the SAI and Camber Angle together. (2)
- any four types of suspension spring. (2)
- ng, Helical Spring or Coil Spring, Torsion Bar, Rubber Springs (2)
- short notes on "LPG". (2)
- petroleum gas or liquid petroleum gas (LPG or LP gas), also referred to as simply propane or is a flammable mixture of hydrocarbon gases used as a fuel in heating appliances, cooking (2)
- it, and vehicles.
- entiate between bio-fuel and bio-diesel. (2)
- iesel is made from vegetable oils (palm oil, soybean oil) and animal fat. Biofuels are made from (2)
- nts other than petroleum derived products such as human and animal wastes, etc.
- el is non-toxic and biodegradable, but some of the biofuels contain toxic gases.
- alcohol is an alternate fuel for S.I engine? (2)
- also having a good calorific value, a good volatility, not much higher ignition energy, average auto (2)
- temperature, it's viscosity also not much higher, easy burning, easy availability, easy storing.
- do you understand by the term hybrid vehicle? (2)
- ybrid electric vehicles (HEVs) combine the internal combustion engine (ICE) of a conventional (2)
- with the battery and electric motor of an electric vehicle.

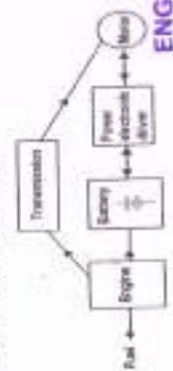

PRINCIPAL.
K. S. R. INSTITUTE FOR
ENGINEERING AND TECHNOLOGY.
K. S. R. KALVI NAGAR,
TIRUCHENGODE-637 215.
www.ksr.edu.in

PART-B

- 9.a) (i) What are the functions of steering system? (5)
- It helps in swinging the wheels to the left or right.
 - It helps in turning the vehicle at the will of the driver.
 - It provides directional stability.
 - It helps in achieving self-centering efforts.
 - It absorbs major part of the road shocks.
- 9.a) (ii) Discuss in detail working method of steering linkage system with suitable sketches. (10)
- A steering system is designed to enable the driver to control the travelled path of a vehicle

- 1. Steering - box :-**
The steering-box provides a gear reduction so that only a small effort, a much larger force can be applied to the steering linkage.
- 2. Drop-arm:-**
This forged lever-arm is bolted on to a tapered steering-box output (rocket-shaft). It is usually positioned so that it hangs or drops down wards. Its swing actum imparts a circular-arc movement to the drag-link
- 3. Drag-link:-**
This tubular rod converts the circular movement of the drop-arm into a linear push or pull motion of the drag-link arm which is rigidly attached to one of the stub-axes.

- 4. Drag-link arm :-**
This arm connects the drag-link to one of the stub-axes. Its function is to provide the leverage to convert the linear drag-link movement to an angular movement about the stub-axle king pin.

- 5. Drag-link suspension and steering interaction:-**
When the axle-beam moves up and down. It does so in a circular arc pivoting about the fixed front shackle-pins. Similarly the drag-link will pivot about the drop-arm ball-joint during any axle vertical movement.

- 6. Stub-axes :-**
Each steered road-wheel is mounted on a short axle-shaft commonly known as a stub-axle. The stub-axle has two extended horizontal prongs which fit over the ends of the axle-beam.

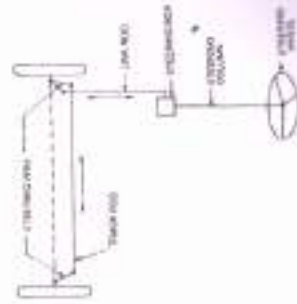

- 7. Track-rod arms:-**
Each stub-axle has a forged track-rod arm rigidly bolted approximately at right angles to the wheel axis in the horizontal plane. The length of this arm provides the leverage to rotate the stub-axle about the king-pin, the rotary movement being transferred to the other stub-axle by means of the track-rod.

- 8. Track-rod:-**
To enable the two stub-axes to pivot together, a tubular rod spins the wheel track. The ends of this rod are fitted with ball-joints which are then bolted to the track-rod arms. When the drag-link moves, it rotates one

ction of braking system

ervice brakes (the ones used while driving for slowing or stopping) to be applied, the brake pedal routing the air under pressure (approx 100–120 psi or 690–830 kPa) to the brake chamber, he brake to be engaged. The air compressor draws filtered air from the atmosphere and forces it -pressure reservoirs at around 120 psi (830 kPa).

essed air brake system is divided into a supply system and a control system. The supply system es, stores and supplies high-pressure air to the control system as well as to additional air auxiliary truck systems (gearbox shift control, clutch pedal air assistance servo, etc.).

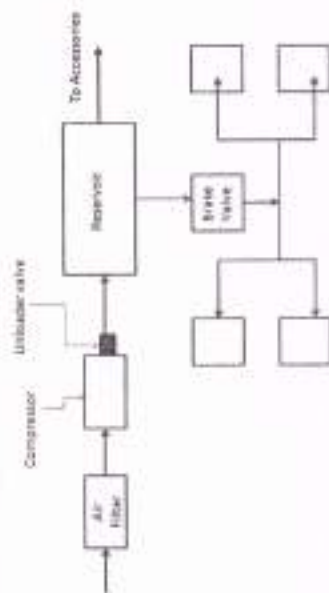

Layout of Air Brake System

ssed air is first routed through a cooling coil and into an air dryer which removes moisture and rities and also may include a pressure regulator, safety valve and smaller purge reservoir. As an ve to the air dryer, the supply system can be equipped with an anti-freeze device and oil r. The compressed air is then stored in a reservoir (also called a wet tank) from which it is then ed via a four way protection valve into the front and rear brake circuit air reservoir, a parking reservoir and an auxiliary air supply distribution point. The system also includes check, pressure limiting, drain and safety valves. Air brake systems may include a wig ice which deploys to warn the driver if the system air pressure drops too low.

Describe the construction and working of hybrid vehicle with neat sketch? (13)

onfiguration

ies HEV, an electric machine, coupled to an ICE, supplies electricity to the electric machine to he vehicle, and to the energy storage system needs to be recharged. As a consequence, the can run at its optimum greatly reducing fuel ption. However, as the electric machine is the one connected to the wheels and the

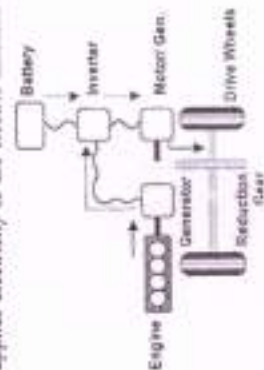

engine-generator set is sized for sustained grade ability; this configuration requires a large energy storage system pack, electric machine and engine, adding inefficiencies and weight.

Parallel Configuration

Parallel hybrids have mechanical connections to the wheels from both the electric machine and the engine. Therefore, it is possible to downsize both the engine and the electric machine compared to series hybrids. Since the ICE speed is linked to the vehicle speed, the ICE can operate close to its best efficiency curve only under certain conditions. However, since both mechanical and electrical energies can be used to directly propel the vehicle, the powertrain efficiency is increased compared to series configuration during most operating conditions.

11.b) Develop and explain the engine modifications to be undertaken in the S.I engine for Alcohols or Ethanol as alternative fuel? (13)

MAIN JET CHANGES: The main metering jet in your carburetor is the first we will tackle. In most all carburetors this will be a threaded brass plug with a hole drilled through the center of it. This hole is called the main jet orifice! This holes diameter directly affects how rich or lean the air/fuel mixture will be when the engine is running at normal speeds. Smaller the hole less fuel/leaner... bigger hole more fuel/richer. Since alcohol requires a richer air to fuel ratio, it's necessary to bore out the main jet orifice when using ethanol fuel. The increase will be on the order of 20 to 40 percent.

IDLE ORIFICE CHANGES: When idling the idle orifice is the only route of fuel to the engine and therefore the fuel flow will need to be increased at idle as well. Many carbureted engines it is a simple matter to adjust a screw with a flathead screw drive to adjust the amount of fuel allowed through at idle

POWER VALVE CHANGES

A power valve that allows fuel to blend with the air when the engine is revved. This vacuum controlled valve is spring loaded, and shuts off when it isn't needed in order to conserve fuel. For most conversions changing fuel flow is important only from an efficiency stand point.

ACCELERATOR PUMP CHANGES

This is a mechanically activated plunger or diaphragm that injects a stream of gas directly into the throat of the carburetor when the accelerator is suddenly depressed. The fuel is injected through a small orifice located in the throat wall before carburetors throat narrows.

COMPRESSION RATIO CHANGES

Increasing the compression ratio will not be covered here. The ratio can be increased to 14 or 15 to 1. Gas is usually at about roughly 8 to one. It isn't imperative to go all the way to 14 or 15 any increase will give you some of the benefit.

PRINCIPAL,
K. S. R. INSTITUTE FOR
ENGINEERING AND TECHNOLOGY,
K. S. R. KALVI NAGAR,
TIRUCHENGODE-637 215,
NAMAKKAL DL, TAMIL NADU

PART-C

(i) What are the merits and demerits of LPG as a motor vehicle fuel? (8)

Due to higher octane rating, the combustion of LPG is smoother and knocking is eliminated and the engine runs smoothly.
 When LPG leaks past the rings into the crankcase, it does not wash oil from cylinder walls and does not generate black carbon. Hence, the lubricating layer is not washed away. Thereby, the engine life is increased by 50%.
 Due to the absence of carbon deposits on the electrodes of the spark plugs, the life of the spark plugs is increased.

Advantages:

LPG reduces the volumetric efficiency due to its high heat of vaporization.
 Handling has to be done under pressure of about 18 bars.
 Its characteristics odor is faint, so leakage cannot be easily detected.

(ii) Write the advantages of LNG? (7)

It makes it possible to use natural gas in areas where natural gas is not available via the national gas network or municipal distribution system.
 It is a more economic source of energy when compared to black products (fuel oil and diesel) and

because of its high energy content, the total amount of energy needed is reduced.

(iii) Explain the construction and working of the PEM fuel cell with sketch. (8)

Proton exchange membrane (PEM) fuel cell has shown in below figure uses a solid polymer electrolyte (perfluorosulphonic acid membrane) in the form of a thin, permeable sheet for the transport of protons. Anode and cathode catalyst used generally is platinum, Pt-black or Pt/Ru catalyst.

Operating principle of a PEMFC is relatively simple: it involves the feeding of hydrogen into the cell to be oxidised at the anode, while the oxygen is reduced at the cathode after being carried in by an air feed. The hydrogen is supplied to this porous anode, while the oxygen is supplied to the cathode, mainly by feeding air into the cathode. The input fuel of hydrogen passes over a negatively charged anode, where it is split into H⁺ ions and e⁻ electrons. The electrons are then transported through an external circuit to produce electric current, while oxygen passes over a positively charged cathode.

The ions go through the electrolyte to the positively charged cathode and react with one another to produce H₂O (water) and heat as products.

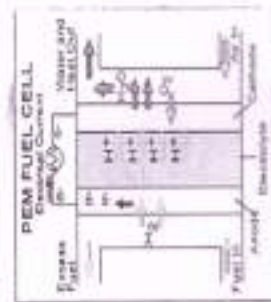
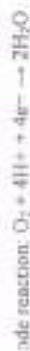

Furthermore, the straight transformation of the chemical energy of covalent bonds into electricity occurs as a result of the split of the hydrogen and oxygen by the electrolyte also referred to as a separator.

12. (b) (ii) Explain any one method of hydrogen production. (7)

Hydrogen from Nuclear Reactors

The fundamental concept behind nuclear-hydrogen system is to use the heat of the reactors to generate hydrogen via thermochemical or electrochemical processes. In other words, a hydrogen production plant is combined with an advanced nuclear power plant, which serves as a heat source in driving the chemical reactions. Fig. illustrates the flow from nuclear reactor to hydrogen production via a thermochemical process to power generation.



Fig : Nuclear reactor system, involving thermochemical process as the hydrogen production method.

In general, the thermal energy generated by the nuclear reactors serves as a primary heat source to produce hydrogen through thermochemical processes. For direct electrolysis of water, a minimum temperature of 2500°C is required for hydrogen production. Through thermochemical processes like the water-splitting cycle which involves a series of chemical reactions, a lower temperature is required to accomplish the same overall results. The overall performance of the nuclear-hydrogen system will depend on the operating conditions, coolant choice, conversion efficiency, and reactor type as these variables will affect the economical and technological feasibility.

Course Instructor/Coordinator
 Module Coordinator
 Programme Coordinator

PRINCIPAL
 K. S. R. INSTITUTE FOR
 ENGINEERING AND TECHNOLOGY
 K. S. R. KALVI NAGAR,
 TIRUCHENGODE-637 21
 (TAMIL NADU)

INTERNAL ASSESSMENT TEST-I

Year/Semester	: III Year/V Semester	Max Marks	: 50
Branch	: EEE	Duration	: 1 Hr 30 min
Subject Code & Title	: EE6503 Power Electronics	Date & Session	: 21.08.2018 FN
Answer ALL the questions		PART-A	
		(5 x 2=10)	
1.	Define is latching & Holding current of SCR?	CO1	K1
2.	What is commutation? What are the types of commutation?	CO1	K1
3.	What is the function of snubber circuit?	CO1	K1
4.	Why IGBT's are popular now days?	CO1	K1
5.	Why power factor of semi converter better than that of full converters?	CO2	K2
		PART-B	
		(2 x 13=26)	
6.	(a) i) Discuss explain the transfer, output and switching characteristics of power MOSFET ii) For a class C commutation circuit the DC source voltage is 120V and current through R1,R2 = 20A. The turn off time of both SCR is 60µs. Calculate the value of commutating capacitance C for a successful commutation.	8	CO1 K1
		5	CO1 K4
(OR)			
6.	(b) Describe basic structure of IGBT and explain its working. Give its equivalent circuit and explain turn ON and turn OFF characteristics	13	CO1 K2
7.	(a) With neat sketch explain the static and dynamic characteristics of SCR	13	CO1 K1
(OR)			
7.	(b) Explain the construction and working principle of TRIAC with different mode of operation.	13	CO1 K2
		PART-C	
		(1 x 14=14)	
8.	(a) Discuss with the aid of schematic diagram and waveforms, the principle of operation of a two quadrant two pulse converter in the rectifying and inverting mode of operation	14	CO2 K2
(OR)			
8.	(b) A single phase fully controlled converter is used for obtaining a regulated DC voltage. The RMS value of the ac input voltage is 230V, and the firing angle is maintained at 60° the load current is 4A. Calculate the i) DC output voltage, active and reactive power input. ii) if SCR 3 is damaged and gets open circuited calculate the average DC voltage and current. For this case freewheeling diode is connected. ($\alpha = 60$)	14	CO2 K4
CO1	Explain the construction and operation of semiconductor devices and their switching characteristics.		
CO2	Determine the various performance indices of controlled rectifiers and its classification		

K1: Remembering K2: Understanding K3: Applying K4: Analyzing K5: Evaluating K6: Creating

% of Remembering	% of Understanding	% of Application and higher order Abilities (K3+K4+K5+K6)	Total
32	45	23	100

Course Instructor/Coordinator

Module Coordinator

Programme Coordinator

PRINCIPAL
K. S. R. INSTITUTE FOR
ENGINEERING AND TECHNOLOGY

**KSR INSTITUTE FOR ENGINEERING AND TECHNOLOGY,
TIRUCHENGODE- 637 215
INTERNAL ASSESSMENT TEST-1
EE6503 Power Electronics – Answer Key**

1. Define latching & Holding current of SCR?

Latching current: is defined as the minimum value of anode current required to **TURN ON** the SCR when gate signal is removed.

Holding current is defined as the minimum value of anode current below which it must **turn- off** the SCR.

2. What is commutation? What are the types of commutation?

The turn off process of thyristor is called commutation.

Line Commutation: The circuit is commutated by nature of the AC supply is called natural or line commutation.

Forced commutation: The circuit is commutated by external commutating elements like inductor and capacitor is called forced commutation.

3. What is the function of snubber circuit?

A snubber circuit consists of a series combination of resistance R_s and C_s in parallel with the thyristors. It is mainly used for dv/dt protection.

4. Why IGBT's are popular now days?

- Lower gate drive requirements
- Lower switching losses
- Smaller snubber circuit requirements

5. Why power factor of semi converter better than that of full converters?

The semi converter receives less reactive power due to freewheeling action when compared with full converter. Therefore, the power factor is better than semi converter.

6.a) Discuss explain the transfer, output and switching characteristics of power MOSFET

SWITCHING CHARACTERISTICS

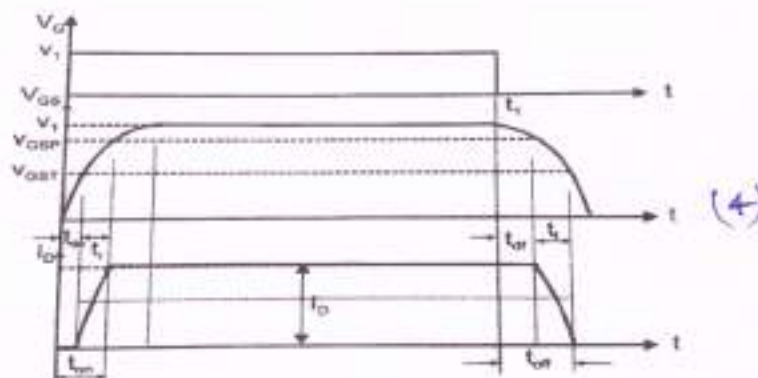

✓ **TURN ON PROCESS:**

- The **turn on time** is defined as the sum of turn – on delay time and rise time of the device.
- **Delay time t_{de}** during this period, input capacitance charges to gate threshold voltage V_{GS} and drain current is zero.
- **Rise time t_r** during this period, gate voltage rises to V_{GS} . It is the gate source peak voltage.

Total turn on time $t_{on} = t_{ds} + t_r$

PRINCIPAL,
K S R. INSTITUTE FOR
ENGINEERING AND TECHNOLOGY,
K. S. R. KALVINAGAR.

- The turn ON time can be reduced by using low impedance gate drive circuit.

✓ **TURN OFF PROCESS:**

- Turn off process is initiated by the removal of V_{GS} at time t_1 , because MOSFET is a majority carrier device.
- The **turn off time** is defined as the sum of turn – off delay time t_{off} and fall time t_f of the device.
- **Delay time t_{off} :** the input capacitance discharges from over drive gate voltage but the drain current does not change.
- **Fall time t_f :** the input capacitance again discharges from V_{GS} to threshold voltage V_{GS1} . Then drain current fall from I_D to zero

Total turn off time $t_{off} = t_{off} + t_f$

6 b) Describe basic structure of IGBT and explain its working. Give its equivalent circuit and explain turn ON and turn OFF characteristics

INSULATED GATE BIPOLAR TRANSISTOR (IGBT)



(1)

- IGBT is a new development in the area of power MOSFET technology.
- This device combines the advantages of both MOSFET and BJT.
- It has three terminals namely Collector (C), Emitter (E) and Gate (G)

V-I CHARACTERISTICS

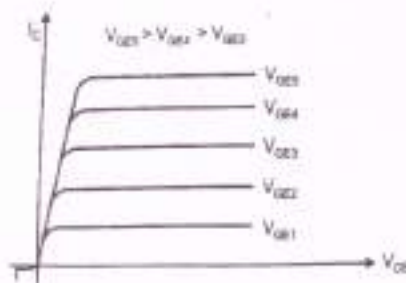

(2)

- It is a plot of collector current I_c versus collector-emitter voltage V_{CE} for various values of gate-emitter voltages.
- In the forward direction, the shape of the output characteristics is similar to that of BJT.

✓ **TRANSFER CHARACTERISTICS**

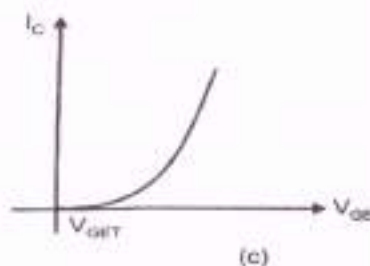

(2)

PRINCIPAL,
K. S. R. INSTITUTE FOR
ENGINEERING AND TECHNOLOGY,
K. S. R. KALVIN NIGAR,
TIRUCHENGODE-637 215.

- It is the plot of collector current I_C versus gate-emitter voltage V_{GE} .
- When gate-emitter voltage V_{GE} is less than threshold voltage V_{GET} , IGBT is in OFF state.

SWITCHING CHARACTERISTICS

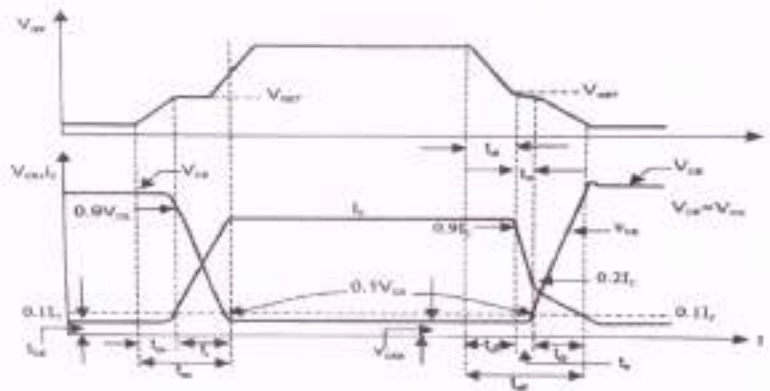

(8)

TURN ON TIME: the time between the instants of forward blocking to forward ON state.

- Turn on time is composed of delay time t_{db} and rise time t_r
- **Delay time t_{db} :** time for the collector emitter voltage falls from V_{CE} to $0.9 V_{CE}$ also defined as the time for the I_C rise from its leakage current I_{CE} to $0.1 I_C$

Rise time t_r : during which collector emitter voltage falls from $0.9 V_{CE}$ to $0.1 V_{CE}$ also defined as I_C rises from $0.1 I_C$ to its final I_C

$$\text{Total Turn on time } t_{on} = t_{db} + t_r$$

- ✓ **TURN OFF TIME:** consists of three interval i) delay time ii) initial fall time t_{f1} iii) final fall time t_{f2} .
- **Delay time t_{df} :** time during which gate voltage falls from V_{GE} to V_{GET} , the I_C falls from I_C to $0.9 I_C$
- **First fall time t_{f1} :** time during which I_C falls from 90 to 20 % of its initial value I_C
- **Final Fall time t_{f2} :** time during which I_C falls from 20 to 10 % of its initial value I_C .

7a) With neat sketch explain the static and dynamic characteristics of SCR

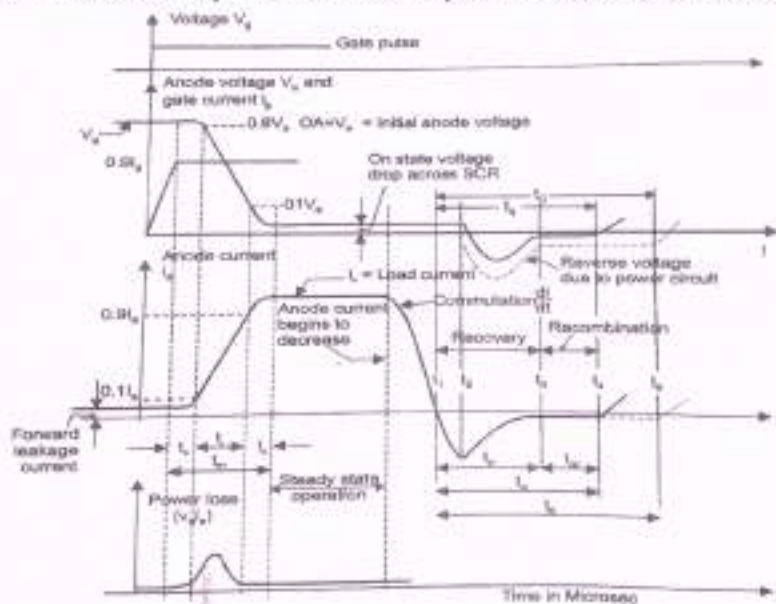

(6)

TURN ON PROCESS

PRINCIPAL
K. S. R. INSTITUTE FOR
ENGINEERING AND TECHNOLOGY,
K. S. R. KALVINAGAR,

- The forward biased thyristor will turn on by applying gate pulse.
 - The transition time from forward off state to forward on state is called **SCR turn on time**.
 - **Total Turn ON time** can be divided into three intervals i) delay time t_d ii) rise time t_r iii) spread time t_p .
- ✓ **Delay time (t_d):** is measured from the instant at which gate current reaches $0.9 I_g$ to the instant at which anode current reaches $0.1 I_a$. The delay time can be also defined as, the time during which anode current rises from forward leakage current to $0.1 I_a$.
- The delay time can be decreased by applying high gate current and more forward voltage between anode & cathode.
 - The delay time is fraction of microseconds
- ✓ **Rise time (t_r):** is the time taken by the anode current to rise from $0.1 I_a$ to $0.9 I_a$.
- Rise time is inversely proportional to the magnitude of gate current and its build up rate. (A)
 - It can be reduced by applying high and steep current pulses to the gate.
 - During rise time, turn on losses in the thyristor are the highest due to high anode voltage (V_a) and large anode current (I_a).
- ✓ **Spread time (t_p):** is the time taken by the anode current rise from $0.9 I_a$ to I_a .
- During this time, conduction spreads over the entire cross section of the cathode of SCR.
 - Its depends on area of cathode and gate structure of SCR.
- Total turn on time (t_{on}) = Delay time (t_d) + Rise time (t_r) + Spread time (t_p)**
 $t_{on} = t_d + t_r + t_p$
- ✓ **Hard firing or overdriven :** when gate current is several times higher than the minimum current required a thyristor is said to be hard firing.

TURN OFF PROCESS (S)

- The dynamic processes of the SCR from conduction state to forward blocking state is called commutation processes or turn off process.
 - The SCR can be turned off by reducing the anode current below holding current.
 - **Turn off time (t_q):** the time between the instant anode current becomes zero and the instant SCR regains forward blocking capability.
 - Turn off time is divided into two intervals: **Reverse recovery time t_{rr}** & **gate recovery time t_{gr}** .
 - At t_1 anode current becomes zero.
 - At t_2 , about 60% of the stored charges are removed from the outer two layers.
 - At t_3 , when reverse recovery current has fallen to nearly zero values. At the end of reverse recovery period ($t_3 - t_1$), the middle junction j_2 still has trapped charges, therefore, SCR is not able to block the forward voltage at t_3 .
- ✓ **Gate recovery time t_{gr} :** The time for the recombination of charges between t_3 and t_4 is called gate recovery time t_{gr} .
- ✓ **Circuit turn off time t_c :** The turn off time provided to the SCR by the practical circuit is called circuit turn off time
- SCR with slow turn off time (50-100 μ s) are called **converter grade SCRs** and those with fast turn off time (3- 50 μ s) are called **inverter grade SCRs**.

7b) Explain the construction and working principle of TRIAC with different mode of operation.
TRIGGERING MODES OF TRIAC

- There are four possible electrode potential combinations as given below
 1. MT2 positive with respect to MT1, G positive with respect to MT1



PRINCIPAL.
K. S. R. INSTITUTE FOR
ENGINEERING AND TECHNOLOGY,
K. S. R. KA...
TIRUCHENGU - 637 215,
TAMIL NADU.

2. MT2 positive with respect to MT1, G negative with respect to MT1
3. MT2 negative with respect to MT1, G negative with respect to MT1
4. MT2 negative with respect to MT1, G positive with respect to MT1

(1)

- The triggering sensitivity is highest with the combinations 1 and 3 and are generally used.

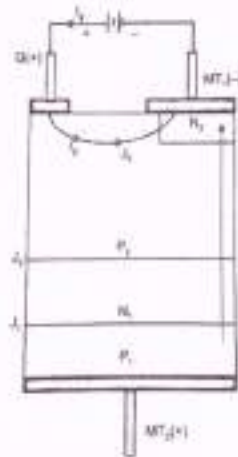
Mode 1: MT2 positive with respect to MT1, G positive with respect to MT1



(2)

- In this trigger mode, the gate current flows mainly through the P_2-N_2 junction like an ordinary thyristor.
- When the gate current has injected sufficient charge into P_2 layer the Triac starts conducting through the $P_1-N_1-P_2-N_2$ layers like an ordinary thyristor.

Mode 2 : MT2 positive with respect to MT1, G negative with respect to MT1

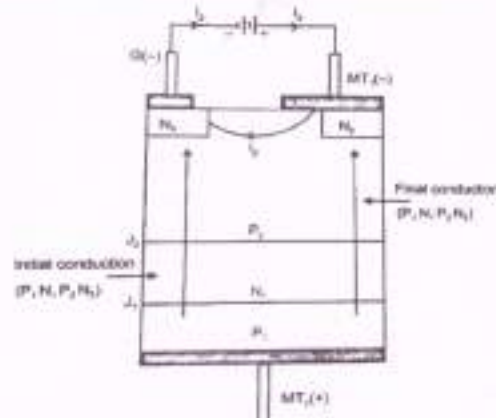

(3)

- The gate current forward biases the gate junction P_2-N_2 .
- Triac starts conducting through $P_2-N_2-P_1-N_1$.
- With the conduction of $P_2-N_2-P_1-N_1$, the voltage drop across it falls but potential of layer P_2-N_2 rises towards the anode potential of MT_2 .

PROFESSOR
M. S. R. INSTITUTE FOR
ENGINEERING AND TECHNOLOGY,
K. S. P. ROAD,
TIRUCHENGODE-617 215,
NAMAKKAL Dt. TAMIL NADU.

- A current is thus established in layer P_2 from the left to right which forward biases P_2N_2 junction and finally the main structure $P_1N_1P_2N_2$ begins to conduct.

Mode 3 : MT2 negative with respect to MT1, G positive with respect to MT1

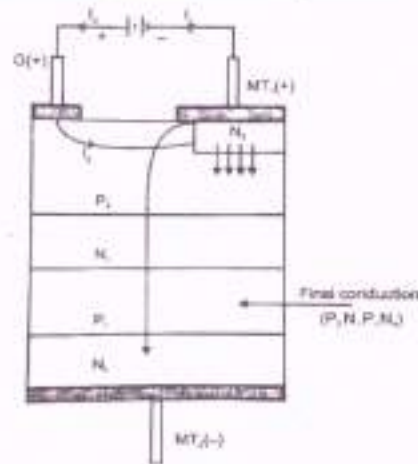

(3)

- The external gate current I_g forward biases P_2N_2 junction.
- The structure $P_2N_1P_1N_2$ completely turn on by regenerative process and it conducts the current.

Mode 4: MT2 negative with respect to MT1, G negative with respect to MT1

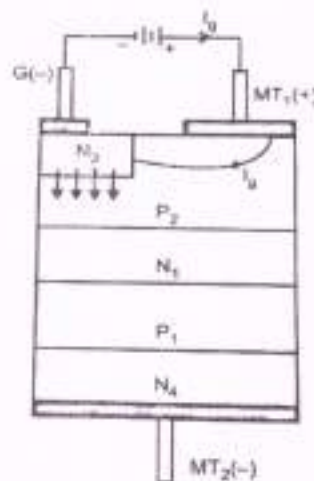

(3)

- In this triggering mode, the gate current I_g forward biases the P_2N_2 junction and a large number of electrons are introduced in the P_2 region by N_2 .
- Finally the structure $P_2N_1P_1N_2$ turns on completely.

8a) Discuss with the aid of schematic diagram and waveforms, the principle of operation of a two quadrant two pulse converter in the rectifying and inverting mode of operation

PRINCIPAL
K. S. R. INSTITUTE FOR
ENGINEERING AND TECHNOLOGY,
K. S. R. KALVI NAGAR,
K. S. R. 637 215.

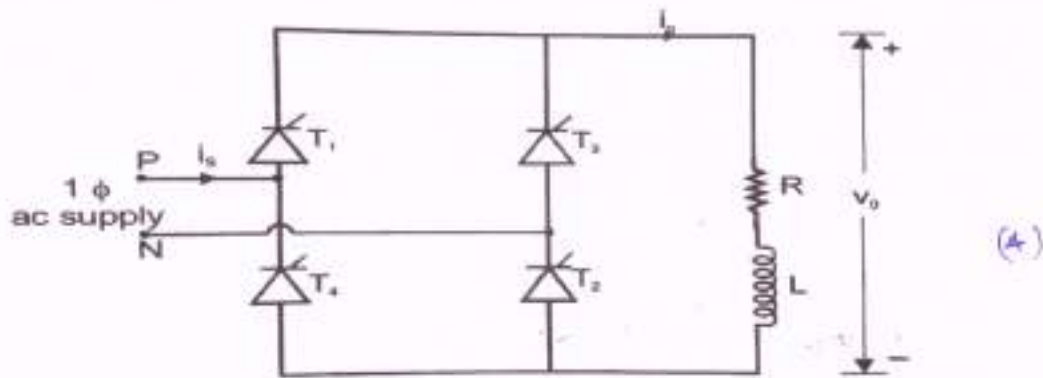

It has two mode of operation

→ Mode I (α to $\pi + \alpha$)

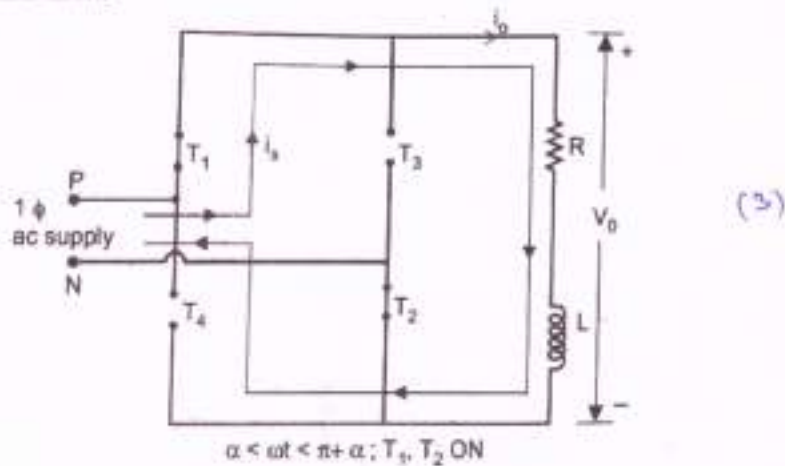

- During the positive half cycle, SCRs T_1 and T_2 are forward biased and if they are triggered simultaneously.
- At $\omega t = \alpha$, SCRs T_1 and T_2 are conducting, then current flows through the path P- T_1 -RL- T_2 -N.
- At $\omega t = \pi$, supply voltage reverses. However, because of very large inductance L , the current is maintained in the same direction at the constant magnitude I , which keeps the thyristor T_1 and T_2 in conducting state and hence, the negative supply voltage appears across the load.

Mode II ($\pi + \alpha$) to $(2\pi + \alpha)$

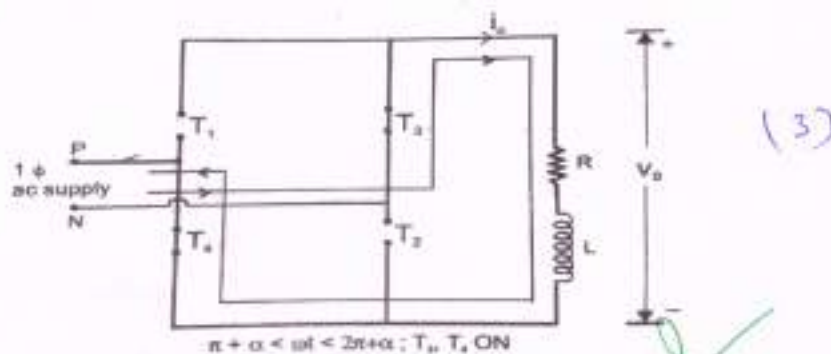

PRINCIPAL,
K. S. R. INSTITUTE FOR
ENGINEERING AND TECHNOLOGY,
K. S. R. KALVI NAGAR,
TIRUCHENGODE-637 215.

KSR INSTITUTE FOR ENGINEERING AND TECHNOLOGY, TIRUCHENGODE- 637 215

INTERNAL ASSESSMENT TEST-I

Year/Semester : III/V
 Branch : Information Technology
 Subject Code & Title : CS8591 – Computer Networks

Max Marks : 50
 Duration : 1 Hr 30 Min
 Date & Session : 15.07.19 & FN

Answer ALL the questions
PART-A (4 x 2=8)

- | | | |
|---|-----|----|
| 1. What are the three criteria necessary for an effective and efficient network? | CO1 | K1 |
| 2. How does sky propagation differ from line-of-sight propagation? | CO1 | K2 |
| 3. For n devices in a network, what is the number of cable links required for a mesh and ring topology? | CO1 | K3 |
| 4. Compare and contrast delay with jitter. | CO1 | K3 |

PART-B (3 x 14=42)

- | | | |
|--|-----|----|
| 1. With a neat sketch, explain the functions of layers in TCP/IP protocol suite. | CO1 | K2 |
| 2. i. For a datagram and packet switched network, a routing table is required to find the output port but a circuit switched network has no need for such a table. Justify your answer. (7) | CO1 | K3 |
| ii. Explain in detail about the types of guided media for transmission. (7) | CO1 | K1 |
| 3. Suppose you are developing the standard for a new type of packet switched. You need to decide whether the network will use VCs or datagram routing. What are the pros and cons for using VCs? | CO1 | K3 |

CO1	Recognize the basic layers and its functions in computer networks and evaluate the performance of a network.
-----	--

K1: Remembering K2: Understanding K3: Applying K4: Analyzing K5: Evaluating K6: Creating

% of Remembering	% of Understanding	% of Application and higher order Abilities (K3+K4+K5+K6)	Total
18%	32%	50%	100%

[Signature]
 Course Instructor/Coordinator

[Signature]
 Module Coordinator

[Signature]
 Program Coordinator

PRINCIPAL,
K. S. R. INSTITUTE FOR
ENGINEERING AND TECHNOLOGY,
K. S. R. KALVI NAGAR,
TIRUCHENGODE - 637 215,
NAMAKKAL Dt, TAMIL NADU.

INTERNAL ASSESSMENT TEST-I Answer Key

Year/Semester	: III/V	Max Marks	: 50
Branch	: Information Technology	Duration	: 1 Hr 30 Min
Subject Code & Title	: CS8591 – Computer Networks	Date & Session	: 15.07.19 & FN

PART-A (4 x 2=8)

1. **What are the three criteria necessary for an effective and efficient network?**

Performance – measured by transit time and response time.

Transit time - time required for a message to travel from one device to another.

Response time is the elapsed time between an inquiry and a response.

Reliability - Frequency of failure, the time it takes a link to recover from a failure.

Security - Protecting data from unauthorized access.

CO1 K1

2. **How does sky propagation differ from line-of-sight propagation?**

Sky propagation

- Higher-frequency radio waves radiate upward into the ionosphere where they are reflected back to earth.
- This type of transmission allows for greater distances with lower output power.

CO1 K2

Line-of-sight propagation

- Very high-frequency signals are transmitted in straight lines directly from antenna to antenna. Antennas must be directional, facing each other and either tall enough or close enough together not to be affected by the curvature of the earth.

3. **For n devices in a network, what is the number of cable links required for a mesh and ring topology?**

Mesh topology – $n(n-1)/2$

Ring topology – $n-1$

CO1 K3

4. **Compare and contrast delay with jitter.**

The latency or delay defines how long it takes for an entire message to completely arrive at the destination from the time the first bit is sent out from the source.

Latency = propagation time + transmission time + queuing time + processing delay

CO1 K3

Jitter is a problem if different packets of data encounter different delays and the application using the data at the receiver site is time-sensitive (audio and video data).

PART-B (3 x 14=42)

With a neat sketch, explain the functions of layers in TCP/IP protocol suite.

1. Physical layer (3)

Physical characteristics of interfaces and media

Representation of bits

Data rate

Transmission mode

2. Data link layer (3)

Framing

Physical addressing

Flow control

Error control

Access control

3. Network Layer (2)

Logical addressing

Routing

4. Transport layer (3)

Segmentation and reassembly

Connection control

CO1 K2

PRINCIPAL,
K. S. R. INSTITUTE FOR
ENGINEERING AND TECHNOLOGY,
K. S. R. KALVI NAGAR,
TIRUCHENGODE - 637 215,
NAMAKKAL Dt, TAMIL NADU.

Flow control

Error control

5. Application layer (3)

Network virtual terminal

File transfer, access & management

Mail services

Directory services

6. i. For a datagram and packet switched network, a routing table is required to find the output port but a circuit switched network has no need for such a table. Justify your answer. (7)

In circuit switching, a dedicated path is available for data transfer and hence it does not require routing table. (1)

A circuit-switched network is made of a set of switches connected by physical links, in which each link is divided into n channels. (1)

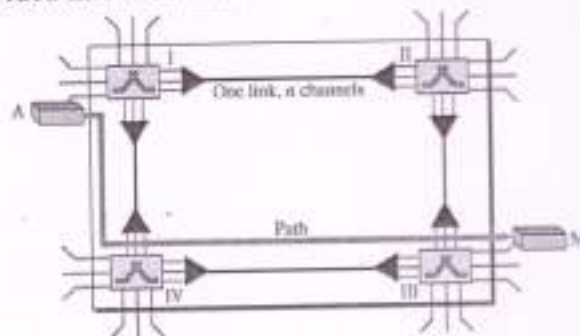

CO1 K3

The actual communication in a circuit-switched network requires three phases:

Setup Phase (1)

Before the two parties can communicate, a dedicated circuit needs to be established.

Data-Transfer Phase (1)

After the establishment of the dedicated circuit, the two parties can transfer data.

Teardown Phase (1)

When one of the parties needs to disconnect, a signal is sent to each switch to release the resources.

Efficiency (1)

Circuit-switched networks are not as efficient as the other two types of networks because resources are allocated during the entire duration of the connection.

Delay (1)

The delay in this type of network is minimal.

- ii. Explain in detail about the types of guided media for transmission. (7)

Guided media provide a medium from one device to another, include (1)

- Twisted-pair cable (2)
- Coaxial cable (2)
- Fiber-optic cable (2)

Twisted-pair cable

A twisted pair consists of two conductors (normally copper), each with its own plastic insulation, twisted together.



STP cable has a metal foil or braided mesh covering that encases each pair of insulated conductors.

CO1 K

PRINCIPAL,
K. S. R. INSTITUTE FOR
ENGINEERING AND TECHNOLOGY,
K. S. R. KALVI NAGAR,

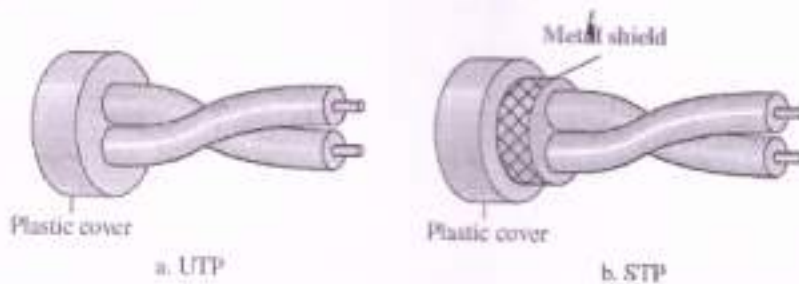

Categories: 1, 2, 3, 4, 5, 5E, 6, 7 (1 & 2 are used for telephone lines and the remaining are used for LANs).

Connectors: UTP connectors are RJ-45 Female and RJ-45 male.

Applications: Telephone companies

Coaxial cable :

Coaxial cable carries signals of higher frequency ranges than those in twisted pair cable. Coax has a central core conductor of solid or stranded wire enclosed in an insulating sheath, which is, in turn, encased in an outer conductor of metal foil, braid, or a combination of the two.



Category: RG-59, RG-58 and RG-11.

Connectors:

- BNC connector
- BNC T connector
- BNC terminator

Applications: Cable TV networks and Ethernet LANs.

Fiber-Optic Cable

A fiber-optic cable is made of glass or plastic and transmits signals in the form of light.

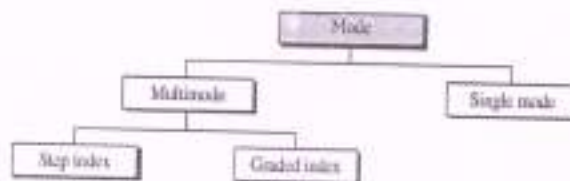
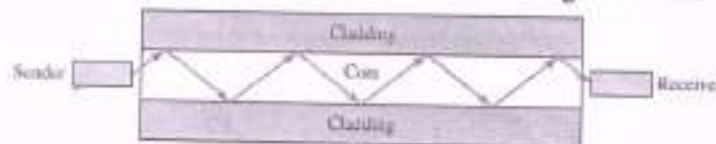

Applications: Cable TV networks and backbone networks.

7. Suppose you are developing the standard for a new type of packet switched. You need to decide whether the network will use VCs or datagram routing. What are the pros and cons for using VCs?

A virtual-circuit network is a cross between a circuit-switched network and a (4) datagram network. It has some characteristics of both.

1. As in a circuit-switched network, there are setup and teardown phases in addition to the data transfer phase.
2. Resources can be allocated during the setup phase, as in a circuit-switched network, or on demand, as in a datagram network.

CO1 K3

PRINCIPAL,
K. S. R. INSTITUTE FOR

3. As in a datagram network, data are packetized and each packet carries an address in the header.
4. As in a circuit-switched network, all packets follow the same path established during the connection.

Virtual-Circuit Identifier (2)

The identifier that is actually used for data transfer is called the *virtual-circuit identifier (VCI)* or the *label*.

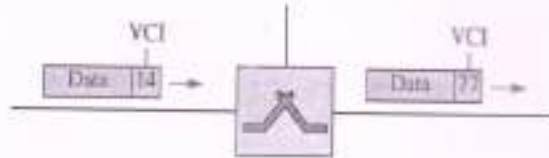

Three Phases

A source and destination need to go through three phases in a virtual-circuit network:

- Setup phase (3)
 - Data transfer phase (4)
 - Teardown phase (1)
- In the setup phase, the source and destination use their global addresses to help switches make table entries for the connection.
 - In the teardown phase, the source and destination inform the switches to delete the corresponding entry.
 - Data transfer occurs between these two phases.

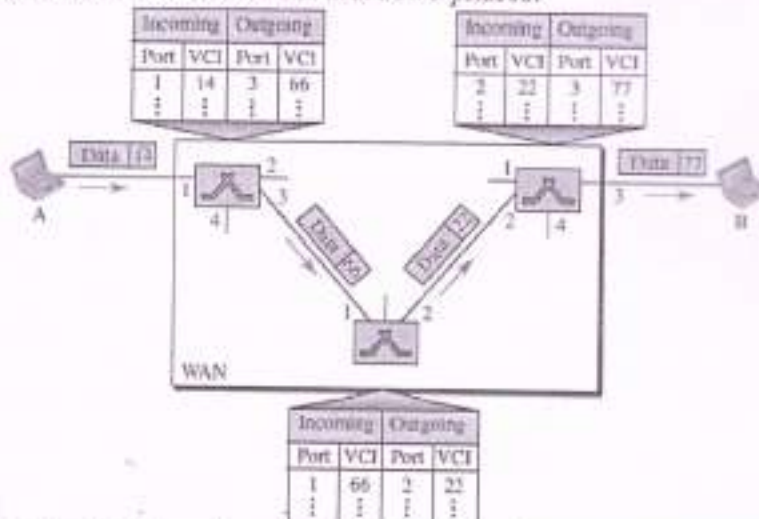

In virtual-circuit switching, all packets belonging to the same source and destination travel the same path, but the packets may arrive at the destination with different delays if resource allocation is on demand.

[Signature]
15/7/19
Course Instructor

[Signature]
Module Coordinator

[Signature]
Program Coordinator

PRINCIPAL,
K. S. R. INSTITUTE FOR
ENGINEERING AND TECHNOLOGY

KSR INSTITUTE FOR ENGINEERING AND TECHNOLOGY, TIRUCEGODE - 637 215

DEPARTMENT OF MECHANICAL ENGINEERING

Result Analysis of IAT with respect to Cos

Regulations -2013

BATCH: 2015-2019

ACADEMIC YEAR 2017-2018

YEAR/ SEM: III /VI

SUBJECT CODE/ NAME: ME6602 - AUTOMOBILE ENGINEERING

S.NO	REG. NO	NAME	CO1 (34)		CO2 (32)		CO3 (34)		CO4 (34)		CO5 (36)	
			Marks obtained	Target ≥ 60% = 21	Marks obtained	Target ≥ 60% = 20	Marks obtained	Target ≥ 60% = 21	Marks obtained	Target ≥ 60% = 21	Marks obtained	Target ≥ 60% = 22
1	731615114060	KABIL L	19	No	20	Yes	11	No	29	Yes	27	Yes
2	731615114061	KANNAN P	24	Yes	20	Yes	9	No	27	Yes	26	Yes
3	731615114062	KARTHICK R	25	Yes	7	No	25	Yes	29	Yes	28	Yes
4	731615114063	KARTHIKEYAN A	26	Yes	20	Yes	23	Yes	30	Yes	28	Yes
5	731615114065	KAVIN KUMAR R	15	No	8	No	23	Yes	28	Yes	20	No
6	731615114066	KAVIPRIYAN S	26	Yes	20	Yes	29	Yes	31	Yes	33	Yes
7	731615114067	KESAVARAJ M	31	Yes	21	Yes	30	Yes	34	Yes	29	Yes
8	731615114068	KISHORE M	25	Yes	20	Yes	26	Yes	30	Yes	24	Yes
9	731615114069	KISHORE KUMAR M	18	No	10	No	17	No	29	Yes	30	Yes
10	731615114070	KUMAR P	27	Yes	20	Yes	26	Yes	28	Yes	31	Yes
11	731615114071	LINGESWAR M	23	Yes	20	Yes	13	No	31	Yes	25	Yes
12	731615114072	LOGANATHAN K	28	Yes	23	Yes	33	Yes	34	Yes	29	Yes
13	731615114073	MADHAN KUMAR M	22	Yes	20	Yes	26	Yes	34	Yes	33	Yes
14	731615114074	MADHUSUDHAN R	16	No	8	No	16	No	26	Yes	20	No
15	731615114075	MANIKANDABOOPATHI B	25	Yes	21	Yes	22	Yes	30	Yes	23	Yes
16	731615114076	MANIKANDAN G	22	Yes	10	No	25	Yes	32	Yes	18	No
17	731615114077	MANIKANDAN P	24	Yes	22	Yes	30	Yes	27	Yes	21	No
18	731615114078	MANIKANDAN S	18	No	23	Yes	22	Yes	25	Yes	28	Yes
19	731615114080	MANOJKUMAR P R	28	Yes	24	Yes	31	Yes	33	Yes	29	Yes
20	731615114081	MANOKARAN P	17	No	20	Yes	10	No	25	Yes	25	Yes
21	731615114082	MOHAMMED EHIYA S	19	No	5	No	7	No	32	Yes	25	Yes
22	731615114083	MOHAN KUMAR R	29	Yes	20	Yes	31	Yes	30	Yes	25	Yes
23	731615114084	MOHAN PRABHU R	25	Yes	21	Yes	26	Yes	26	Yes	21	No
24	731615114086	NANDHAKUMAR M	26	Yes	22	Yes	17	No	34	Yes	32	Yes
25	731615114087	NANDHAKUMAR S (6/10/97)	27	Yes	29	Yes	28	Yes	33	Yes	32	Yes
26	731615114088	NANDHAKUMAR S (22/8/98)	23	Yes	20	Yes	14	No	31	Yes	28	Yes
27	731615114089	NARENDHIRAN M	25	Yes	26	Yes	17	No	25	Yes	24	Yes
28	731615114090	NAVANEETHAN R	22	Yes	8	No	22	Yes	31	Yes	18	No
29	731615114091	NAVEEN M (20/3/97)	23	Yes	21	Yes	23	Yes	26	Yes	20	No
30	731615114092	NAVEEN M (20/6/97)	20	No	5	No	14	No	24	Yes	21	No
31	731615114093	NAVEEN N	25	Yes	21	Yes	26	Yes	30	Yes	28	Yes

PRINCIPAL,
K. S. R. INSTITUTE FOR
ENGINEERING AND TECHNOLOGY

32	731615114094	NAVEEN KUMAR B	27	Yes	20	Yes	24	Yes	31	Yes	22	Yes
33	731615114095	NAVEEN KUMAR N (6.1.97)	20	No	20	Yes	9	No	26	Yes	22	Yes
34	731615114096	NAVEEN KUMAR N (8.6.98)	25	Yes	20	Yes	22	Yes	28	Yes	26	Yes
35	731615114097	NISHANTH E	23	Yes	10	No	23	Yes	30	Yes	20	No
36	731615114100	OM ADHAVAN B	27	Yes	21	Yes	32	Yes	29	Yes	18	No
37	731615114101	PALANISAMY R	25	Yes	20	Yes	19	No	26	Yes	20	No
38	731615114102	PRAKASH R	21	Yes	20	Yes	19	No	26	Yes	31	Yes
39	731615114103	PRASANNAKUMAR M	24	Yes	21	Yes	22	Yes	29	Yes	31	Yes
40	731615114104	PRAVEEN R	28	Yes	21	Yes	19	No	29	Yes	20	No
41	731615114105	PRINSHITH P	24	Yes	21	Yes	24	Yes	30	Yes	23	Yes
42	731615114106	PRITAM BHATTACHARYA G	23	Yes	20	Yes	18	No	29	Yes	20	No
43	731615114107	PUGAZHENDI S K	29	Yes	28	Yes	32	Yes	31	Yes	33	Yes
44	731615114108	PUVIYARASAN N	27	Yes	6	No	22	Yes	27	Yes	33	Yes
45	731615114109	RAGU S	19	No	21	Yes	24	Yes	29	Yes	21	No
46	731615114110	RAJAMANI M	19	No	20	Yes	31	Yes	30	Yes	27	Yes
47	731615114111	RAMANA SARATHI A T	15	No	10	No	16	No	28	Yes	19	No
48	731615114112	RAMESH M	24	Yes	13	No	28	Yes	32	Yes	33	Yes
49	731615114113	RAM KUMAR M	25	Yes	20	Yes	28	Yes	28	Yes	31	Yes
50	731615114114	RANJITH R	9	No	4	No	14	No	29	Yes	16	No
51	731615114115	ROBERT SAM DANIEL	27	Yes	22	Yes	27	Yes	27	Yes	30	Yes
52	731615114304	BOOPATHI S	18	No	21	Yes	24	Yes	32	Yes	23	Yes
53	731615114305	DINESH S	23	Yes	21	Yes	22	Yes	30	Yes	26	Yes
54	731615114306	ELAVARASAN D	16	No	12	No	22	Yes	26	Yes	13	No
55	731615114308	GOWTHAM V	22	Yes	13	No	20	No	30	Yes	24	Yes
56	731615114309	KARTHIK G	22	Yes	2	No	24	Yes	24	Yes	8	No
57	731615114310	KARTHIKEYAN K	13	No	13	No	14	No	24	Yes	15	No
58	731615114312	MAHESHWARAN K	22	Yes	13	No	21	Yes	28	Yes	25	Yes
59	731615114501	GOWTHAMRAJ T	25	Yes	11	No	28	Yes	31	Yes	30	Yes
60	731615114702	KATHIRAVAN S	28	Yes	12	No	24	Yes	28	Yes	25	Yes

Total Strength	60	60	60	60	60
No. of Students Appeared	60	60	60	60	60
No. of Students Scored 60% and above	44	40	40	60	41
Target Level	2	2	2	2	2
Attainment level	3	2	2	3	2
Attained or not	Yes	Yes	Yes	Yes	Yes

COURSE INSTRUCTOR/COORDINATOR

MODULE COORDINATOR

PROGRAM COORDINATOR

Batch of Students	Description	Target level
2014-2018	60% to 64% of students securing "60%" and above in each course	1
2015-2019	65% to 69% of students securing "60%" and above in each course	2
2016-2020	≥70% of students securing "60%" and above in each course	3

PRINCIPAL
K. S. R. INSTITUTE FOR
ENGINEERING AND TECHNOLOGY
K. S. R. KALVINARAO

S. No	Subject Name		ME6602 Automobile Engineering		
	Student Reg. No.	Student Name	Grade	Equivalent Mark	Target >=60%
1	731615114060	KABIL L	E	50	NO
2	731615114061	KANNAN P	E	50	NO
3	731615114062	KARTHICK R	D	60	YES
4	731615114063	KARTHIKEYAN A	D	60	YES
5	731615114065	KAVINKUMAR R	D	60	YES
6	731615114066	KAVIPRIYAN S	D	60	YES
7	731615114067	KESAVARAJ M	D	60	YES
8	731615114068	KISHORE M	C	70	YES
9	731615114069	KISHORE KUMAR M	D	60	YES
10	731615114070	KUMAR P	C	70	YES
11	731615114071	LINGESWAR M	D	60	YES
12	731615114072	LOGANATHAN K	B	80	YES
13	731615114073	MADHAN KUMAR M	C	70	YES
14	731615114074	MADHUSUDHAN R	E	50	NO
15	731615114075	MANIKANDABOOPATHI B	D	60	YES
16	731615114076	MANIKANDAN G	E	50	NO
17	731615114077	MANIKANDAN P	A	90	YES
18	731615114078	MANIKANDAN S	C	70	YES
19	731615114080	MANOJKUMAR P R	C	70	YES
20	731615114081	MANOKARAN P	U	0	NO
21	731615114082	MOHAMMED EHIYA S	D	60	YES
22	731615114083	MOHANKUMAR R	C	70	YES
23	731615114084	MOHANPRABHU K	D	60	YES
24	731615114086	NANDHAKUMAR M	D	60	YES
25	731615114087	NANDHAKUMAR S (6/10/97)	C	70	YES
26	731615114088	NANDHAKUMAR S (22/8/98)	C	70	YES
27	731615114089	NARENDRIRAN M	D	60	YES
28	731615114090	NAVANEETHAN R	E	50	NO
29	731615114091	NAVEEN M (20/3/97)	D	60	YES
30	731615114092	NAVEEN M (20/6/97)	U	0	NO
31	731615114093	NAVEEN N	E	50	NO
32	731615114094	NAVEENKUMAR B	D	60	YES
33	731615114095	NAVEEN KUMAR N (6.1.97)	E	50	NO
34	731615114096	NAVEEN KUMAR N (8.6.98)	E	50	NO
35	731615114097	NISHANTH E	E	60	YES

36	731615114100	OMADHAVAN B	D	60	YES
37	731615114101	PALANISAMY R	U	0	NO
38	731615114102	PRAKASH R	B	80	YES
39	731615114103	PRASANNAKUMAR M	C	70	YES
40	731615114104	PRAVEEN R	E	50	NO
41	731615114105	PRINSHITH P	C	70	YES
42	731615114106	PRITAM BHATTACHARYA G	D	60	YES
43	731615114107	PUGAZHENDI S K	A	90	YES
44	731615114108	PUVIYARASAN N	D	60	YES
45	731615114109	RAGU S	E	50	NO
46	731615114110	RAJAMANI M	E	50	NO
47	731615114111	RAMANA SARATHI A T	E	50	NO
48	731615114112	RAMESH M	E	50	NO
49	731615114113	RAMKUMAR M	E	50	NO
50	731615114114	RANJITH R	U	0	NO
51	731615114115	ROBERT SAM DANIEL	C	70	YES
52	731615114304	BOOPATHI S	C	70	YES
53	731615114305	DINESH S	D	60	YES
54	731615114306	ELAVARASAN D	U	0	NO
55	731615114308	GOWTHAM V	E	50	NO
56	731615114309	KARTHIK G	U	0	NO
57	731615114310	KARTHIKEYAN K	E	50	NO
58	731615114312	MAHESWARAN K	D	60	YES
59	731615114501	GOWTHAMRAJ T	D	60	YES
60	731615114702	KATHIRAVAN S	C	70	YES
Total Strength				60	
No. of students appeared				60	
No. of students scored "D" Grade and Above				38	
% Of students attained target level				63.33	
Target level				2	
Attainment level				1	
Attained or Not				NO	

Course Instructor / Course Coordinator

Module Coordinator

Programme Coordinator

PRINCIPAL
K. S. R. INSTITUTE FOR
ENGINEERING AND TECHNOLOGY
K. S. R. KALVI NAGAR,
TIRUCHENGODE-637 215
ARASIKAL DI, TAMIL NADU

K S R INSTITUTE FOR ENGINEERING AND TECHNOLOGY, TIRUCHENGODE-637 21

Subject Code & Subject Name	CS8591 - Computer Networks	Regulation	R2017
Academic Year & Semester	2019- 2020 (ODD)	Year / Sem.	III / V
Name of the Faculty	K.G.Lavanya, AP/IT	Degree / Branch	B.Tech. / IT

Batch : 2017 - 2021

Analysis of CO attainment in IAT-1

S. No.	Reg. No.	Name of the Student	CO 1		IATI (50 Marks)
			10- 1,2,3,4,5, 6,7 (50Marks)	Target 2 70% = 35	
1	731617205001	AJAY SRIRAM K	18	No	18
2	731617205002	ARUL MOZHI M	39	Yes	39
3	731617205003	BABU U S	36	Yes	36
4	731617205004	BALAMURUGAN S	35	Yes	35
5	731617205005	CHANDRU M	20	No	20
6	731617205006	DHANUSH ADIT R	21	No	21
7	731617205007	DHINAKARAN K	20	No	20
8	731617205008	DINESH KUMAR P	17	No	17
9	731617205010	GIRINATH S	35	Yes	35
10	731617205011	GOBIKA M	38	Yes	38
11	731617205012	GOKULAN S	13	No	13
12	731617205013	HARI PRASATH K	36	Yes	36
13	731617205014	JESSICA COLLINS	39	Yes	39
14	731617205015	JOSHUA DANIEL B	35	Yes	35
15	731617205016	JOTHEESHWARAN R	38	Yes	38
16	731617205018	KALIDASS R	36	Yes	36
17	731617205019	KANNAN P	21	No	21
18	731617205021	KARTHIK T	21	No	21
19	731617205024	KEERTHIVARMA K S	22	No	22
20	731617205025	LAKSHMANAN R	41	Yes	41
21	731617205026	MANIKANDAN A	35	Yes	35
22	731617205027	MOUNISH G	36	Yes	36
23	731617205028	MUKESH KANNA R	20	No	20
24	731617205030	NANDHINI S	44	Yes	44
25	731617205031	NATHIYA V	11	No	11
26	731617205032	NAVEEN KUMAR G	14	No	14
27	731617205033	NAVEENKUMAR G	35	Yes	35

PRINCIPAL,
K. S. R. INSTITUTE FOR
ENGINEERING AND TECHNOLOGY,
KALVI NAGAR.

S. No.	Reg. No.	Name of the Student	IQ- 1,2,3,4,5, 6,7 (50Marks)	Target: 70% = 35	(50 Marks)
28	731617205034	NIRMALKUMAR G	36	Yes	36
29	731617205035	PAVITHRA S	38	Yes	38
30	731617205036	PRIYADHARSHINI P	36	Yes	36
31	731617205037	RAGU G	37	Yes	37
32	731617205038	RAJARAVEENDHAR G E	13	No	13
33	731617205039	SAANTHOSH BALAJI S	20	No	20
34	731617205040	SANDHIYA G	40	Yes	40
35	731617205041	SANTHOSH KUMAR R	43	Yes	43
36	731617205042	SARAN V	27	No	27
37	731617205044	SATHISHKUMAR V	11	No	11
38	731617205045	SELVAMALAR P	40	Yes	40
39	731617205046	SHAILAA P M	37	Yes	37
40	731617205047	SHIVANI N	26	No	26
41	731617205048	SIVASANKARI R	37	Yes	37
42	731617205049	SREEMATHI INDRA S	39	Yes	39
43	731617205050	SRIRAM S	36	Yes	36
44	731617205051	THANEESWARAN Y G	39	Yes	39
45	731617205052	THUSMEENA K R	38	Yes	38
46	731617205053	VENKATESWARAN S	35	Yes	35
47	731617205054	VIMALRAJ G	12	No	12
48	731617205055	VINOTHINI R	17	No	17
49	731617205701	ASHOK KUMAR S	36	Yes	36
Total Strength			49		49
No. of Students Appeared			49		49
No. of Students Scored 70% and above			30		32
% of Students Scored 70% and above			61%		65.31%
Attainment level			3		

A. S. Anand
18/11/19
Course Instructor

M. S. S. S.
Module Coordinator

P. M. S.
18/11/19
Program Coordinator

Batch	Description	Level
2016 - 2020	≤45% of students securing 70% marks and above	1
2017 - 2021	46% to 55% of students securing 70% marks and above	2
2018 - 2022		
2019 - 2023	>55% of students securing 70% marks and above	3

PRINCIPAL,
K. S. R. INSTITUTE FOR
ENGINEERING AND TECHNOLOGY,
K. S. R. KALVI, S. GAR.
17 215.