



K S R Institute for Engineering and Technology

Tiruchengode, Namakkal (Dt), Tamil Nadu

(Approved by AICTE New Delhi & Affiliated to Anna University Chennai)

BE (CSE, EEE, ECE, Mech) & B.Tech (IT) Programmes are Accredited by NBA

5.1.3 Capacity building and skills enhancement initiatives taken by the institution

ACADEMIC YEAR - 2018-2019

S.No	Academic year	Page No
1	Soft Skills	02 – 245
2	Language and Communication Skills	246 – 381
3	Life Skills (Yoga, physical fitness, health and hygiene)	382 – 400
4	ICT/Computing skills	401 - 620

1. SOFT SKILLS

K S R INSTITUTE FOR ENGINEERING AND TECHNOLOGY

SOFT SKILLS CONSOLIDATED LIST

Academic Year:2018-2019

S.NO.	Name of the capability enhancement program	Date of implementation (DD-MM-YYYY)	Number of students enrolled	Name of the agencies/consultants involved with contact details (if any)
1	Internal Aptitude Training	11.06.2018	360	KSRIET , placement@ksriet.ac.in
2	Industry Readiness Programme	12.06.2018	340	KSRIET , placement@ksriet.ac.in
3	External Aptitude Training Programme	23.07.2018	139	Talent 2 success Learning,coo@t2slearning.com
4	External Training Programme(Quantitative, Reasoning and Verbal) - Batch 1,2 and 3	20.08.2018	139	Six Phrase Training Agency, Six Phrase@gmail.com
5	Company Specific(Wipro) External Training Programme	04.09.18	127	Six Phrase Training Agency, Six Phrase@gmail.com
6	Borg Warner Aptitude Training	05.12.2018	8	KSRIET , placement@ksriet.ac.in
7	Company Specific(Infosys) External Training Programme	08.12.2018	28	Six Phrase Training Agency, Six Phrase@gmail.com

PRINCIPAL

PRINCIPAL,
K. S. R. INSTITUTE FOR
ENGINEERING AND TECHNOLOGY,
K. S. R. KALVI NAGAR,
TIRUCHENGODE - 637 215,
NAMAKKAL DISTRICT, TAMIL NADU.

Training Schedule [2018 - 2019] Odd Semester

Ref: KSRIET/T&P/CIR/2018-19

Date: 22.05.2018

This is to inform all the HoD's, Faculties & Department Training and Placement coordinators that the Internal Training for II year, III year & IV year PRP students on various topics for the academic year 2018 - 2019 (Odd Sem) has been scheduled. All the registered students should attend the Training Programme without fail. If any student skips this Training Programme without proper permission from the respective HoDs, he / she will not be permitted for any further Training Programme and campus recruitment process. Proper Dress Code is mandatory.

Encl.,

Detailed Training Schedule - Year Wise

T&P OFFICER

T&P COORDINATOR

PRINCIPAL

Copy to:

1. All HoDs
2. Notice Board

PRINCIPAL.
K. S. R. INSTITUTE FOR
ENGINEERING AND TECHNOLOGY,
K. S. R. KALVI NAGAR,
TIRUCHENGODE-637 215,
NAMAKKAL DI, TAMIL NADU.

K S R INSTITUTE FOR ENGINEERING AND TECHNOLOGY, TIRUCHENGODE - 637215

Training and placement Cell

II Year Training Schedule [Odd Semester]

Batch: 2017- 2021

Academic Year:2018- 2019

Branch	Day 1		Day 2		Day 3		Day 4		Day 5		Day 6	
	Date	Topics	Date	Topics	Date	Topics	Date	Topics	Date	Topics	Date	Topics
CSE	11.06.18	Basic Programming Skills in C	12.06.18	Basic Programming Skills in C	13.06.18	Basic Communication Skills	14.06.18	Basic Communication Skills	21.06.18	Basic Aptitude Skills	22.06.18	Basic Aptitude Skills
Faculty Name	CSE / IT Faculty		CSE / IT Faculty		Dr.C.Muhuntarajan HoD / English		Dr.C.Muhuntarajan HoD / English		Prof.M.S.Vijayaraj HoD / Maths		Prof.M.S.Vijayaraj HoD / Maths	
IT	11.06.18	Basic Programming Skills in C	12.06.18	Basic Programming Skills in C	13.06.18	Basic Aptitude Skills	14.06.18	Basic Aptitude Skills	25.06.18	Basic Communication Skills	26.06.18	Basic Communication Skills
Faculty Name	CSE / IT Faculty		CSE / IT Faculty		Prof.M.S.Vijayaraj HoD / Maths		Prof.M.S.Vijayaraj HoD / Maths		Dr.C.Muhuntarajan HoD / English		Dr.C.Muhuntarajan HoD / English	
EEE	11.06.18	Basic Programming Skills in C	12.06.18	Basic Programming Skills in C	21.06.18	Basic Communication Skills	22.06.18	Basic Communication Skills	25.06.18	Basic Aptitude Skills	26.06.18	Basic Aptitude Skills
Faculty Name	CSE / IT Faculty		CSE / IT Faculty		Dr.C.Muhuntarajan HoD / English		Dr.C.Muhuntarajan HoD / English		Prof.M.S.Vijayaraj HoD / Maths		Prof.M.S.Vijayaraj HoD / Maths	
ECE A	11.06.18	Basic Aptitude Skills	12.06.18	Basic Aptitude Skills	18.06.18	Basic Programming Skills in C	19.06.18	Basic Programming Skills in C	28.06.18	Basic Communication Skills	29.06.18	Basic Communication Skills
Faculty Name	Prof.M.S.Vijayaraj HoD / Maths		Prof.M.S.Vijayaraj HoD / Maths		CSE / IT Faculty		CSE / IT Faculty		Dr.C.Muhuntarajan HoD / English		Dr.C.Muhuntarajan HoD / English	
ECE B	11.06.18	Basic Communication Skills	12.06.18	Basic Communication Skills	18.06.18	Basic Programming Skills in C	19.06.18	Basic Programming Skills in C	28.06.18	Basic Aptitude Skills	29.06.18	Basic Aptitude Skills
Faculty Name	Dr.C.Muhuntarajan HoD / English		Dr.C.Muhuntarajan HoD / English		CSE / IT Faculty		CSE / IT Faculty		Prof.M.S.Vijayaraj HoD / Maths		Prof.M.S.Vijayaraj HoD / Maths	

PRINCIPAL.
K. S. R. INSTITUTE FOR
ENGINEERING AND TECHNOLOGY,
K. S. R. KALVI NAGAR,
TIRUCHENGODE-637 215,
NAMAKKAL Dt. TAMIL NADU.

Branch	Day 1		Day 2		Day 3		Day 4		Day 5		Day 6	
	Date	Topics	Date	Topics	Date	Topics	Date	Topics	Date	Topics	Date	Topics
MEC A	13.06.18	Basic Programming Skills in C	14.06.18	Basic Programming Skills in C	18.06.18	Basic Aptitude Skills	19.06.18	Basic Aptitude Skills	02.07.18	Basic Communication Skills	03.07.18	Basic Communication Skills
Faculty Name	CSE / IT Faculty		CSE / IT Faculty		Prof.M.S.Vijayaraj HoD / Maths		Prof.M.S.Vijayaraj HoD / Maths		Dr.C.Muhuntarajan HoD / English		Dr.C.Muhuntarajan HoD / English	
MEC B	13.06.18	Basic Programming Skills in C	14.06.18	Basic Programming Skills in C	18.06.18	Basic Communication Skills	19.06.18	Basic Communication Skills	02.07.18	Basic Aptitude Skills	03.07.18	Basic Aptitude Skills
Faculty Name	CSE / IT Faculty		CSE / IT Faculty		Dr.C.Muhuntarajan HoD / English		Dr.C.Muhuntarajan HoD / English		Prof.M.S.Vijayaraj HoD / Maths		Prof.M.S.Vijayaraj HoD / Maths	

V. K. K. K.
T & P OFFICER

[Signature]
T & P COORDINATOR 20/5/18

[Signature]
PRINCIPAL

✓
PRINCIPAL
K. S. R. INSTITUTE FOR
ENGINEERING AND TECHNOLOGY,
K. S. R. KALVI NAGAR,
TIRUCHENGODE-637 215,
NAMAKKAL DI, TAMIL NADU.

Training Topics			Aptitude Skills				Programming Skills in C				Communication Skills			
Trainer			Prof.M.S.Vijayaraj HoD/Maths				D. Balakrishnan AP/IT				Dr.C.Muhuntarajan HoD/Eng			
Trainng Date			11.06.18		12.06.18		18.06.18		19.06.18		28.06.18		29.06.18	
S. No		Name	FN	AN	FN	AN	FN	AN	FN	AN	FN	AN	FN	AN
1	731617106001	AARTHI G	a	a	a				DC					
2	731617106002	ABINAYA T	l	l	a	a	a	a	l	l	l	l	l	l
3	731617106003	ALKA P	a	a	l	l	l	l	l	l	l	l	l	l
4	731617106004	ANBAZHAGAN K	l	l	l	l	l	l	l	l	l	l	l	l
5	731617106005	ASHWINKUMAR V	← →				Discontinue				← →			
6	731617106006	BALAKUMARAN N	l	l	l	l	l	l	l	l	l	l	l	l
7	731617106007	BOOMA V	l	l	l	l	l	l	l	l	l	l	l	l
8	731617106008	DARANIDARAN R S	l	l	l	l	l	l	l	l	l	l	l	l
9	731617106009	DEEPA R	← →				DC				← →			
10	731617106010	DHANISH V	l	l	l	l	l	l	l	l	l	l	l	l
11	731617106011	DHANUSHKODI N	l	l	l	l	l	l	l	l	l	l	l	l
12	731617106012	DHARNISH K	l	l	l	l	l	l	l	l	l	l	l	l
13	731617106013	DHARSHAN T K	l	l	l	l	l	l	l	l	l	l	l	l
14	731617106014	DINESH U G	a	a	l	l	l	l	a	a	l	l	l	l
15	731617106015	DINNESH P	l	l	l	l	l	l	l	l	l	l	l	l
16	731617106016	GEETHARANI G	l	l	l	l	l	l	l	l	l	l	l	l
17	731617106017	GOKULNATH N	l	l	l	l	l	l	l	l	l	l	l	l
18	731617106018	GOKULNATH R	l	l	l	l	l	l	l	l	l	l	l	l
19	731617106019	GOWTHAM M	l	l	a	a	l	l	l	l	l	l	l	l
20	731617106020	HARI HARA SUDHAN R	l	l	l	l	l	l	l	l	l	l	l	l
21	731617106021	HARIKRISHNAN M	a	a	l	l	l	l	l	l	l	l	l	l
22	731617106022	HARISHKUMAR R	l	l	l	l	l	l	l	l	l	l	l	l
23	731617106023	HEMAHARINI S	l	l	l	l	l	l	l	l	l	l	l	l
24	731617106024	HEMALATHA S	a	a	l	l	l	l	l	l	l	l	l	l
25	731617106025	JANARTH S	l	l	l	l	l	l	l	l	l	l	l	l
26	731617106026	JANARTHANAN D	← →				DC				← →			
27	731617106027	JAWAHAR RAJA P	l	l	l	l	l	l	l	l	l	l	l	l
28	731617106028	KAMALESHWARAN R	a	a	l	l	l	l	l	l	l	l	l	l
29	731617106029	KAMALINI N	l	l	l	l	l	l	l	l	l	l	l	l
30	731617106030	KARTHIKA C	l	l	a	a	l	l	l	l	l	l	l	l
31	731617106031	KEERTHANA S	l	l	l	l	l	l	l	l	l	l	l	l
32	731617106032	KEERTHIVASAN N	a	a	l	l	l	l	l	l	l	l	l	l
33	731617106033	KISHOR M	a	a	l	l	l	l	l	l	l	l	l	l

PRINCIPAL.
K. S. R. INSTITUTE FOR
ENGINEERING AND TECHNOLOGY,
K. S. R. KALVI NAGAR,
TIRUCHENGODE-637 215,
NAMAKKAL DI, TAMIL NADU.

Trainng Date			11.06.18		12.06.18		18.06.18		19.06.18		28.06.18		29.06.18	
S. No		Name	FN	AN	FN	AN	FN	AN	FN	AN	FN	AN	FN	AN
34	731617106034	KISHORE D	/	/	/	/	/	/	/	/	/	/	/	/
35	731617106035	LAKSHMANAN S	/	/	/	/	/	/	/	/	/	/	/	/
36	731617106036	MADHANGOPAL C	/	/	a	a	/	/	/	/	/	/	a	a
37	731617106037	MANIMALA R	/	/	/	/	/	/	/	/	/	/	/	/
38	731617106038	MANJULA T	/	/	/	/	/	/	a	a	/	/	/	/
39	731617106039	MERINKUMAR L	/	/	/	/	/	/	/	/	/	/	/	/
40	731617106040	MUSHIDHA SIFANA T	/	/	/	/	/	/	/	/	/	/	/	/
41	731617106041	MUTHULAKSHMI S	a	a	/	/	/	/	/	/	/	/	/	/
PRESENT														
ABSENT														
PERMISSION														
OD														

PRINCIPAL.
K. S. R. INSTITUTE FOR
ENGINEERING AND TECHNOLOGY,
K. S. R. KALVI NAGAR,
TIRUCHENGODE-637 215,
NAMAKKAL Dt, TAMIL NADU.

Training Topics			Programming Skills in C				Aptitude Skills				Communication Skills			
Trainer			S Nandagopal AP/IT				Prof.M.S.Vijayaraj HoD/Maths				Dr.C.Muhuntarajan HoD/Eng			
Trainng Date			11.06.18		12.06.18		13.06.18		14.06.18		25.06.18		26.06.18	
S. No	Reg No	Name	FN	AN	FN	AN	FN	AN	FN	AN	FN	AN	FN	AN
1	731617205001	AJAY SRIRAM K	a	a	/	/	/	/	a	a	/	/	/	/
2	731617205002	ARULMOZHI M	/	/	/	/	/	/	/	/	/	/	/	/
3	731617205003	BABU U S	/	/	/	/	/	/	/	/	/	/	/	/
4	731617205004	BALAMURUGAN S	/	/	/	/	/	/	/	/	/	/	/	/
5	731617205005	CHANDRU M	/	/	/	/	/	/	/	/	/	/	/	/
6	731617205006	DHANUSH ADIT R	/	/	/	/	/	/	/	/	/	/	/	/
7	731617205007	DHINAKARAN B	/	/	/	/	/	/	/	/	/	/	/	/
8	731617205008	DINESH KUMAR P	/	/	/	/	/	/	/	/	/	/	/	/
9	731617205009	DIVYA P	a	a	a	a	a	a	a	a	a	a	a	a
10	731617205010	GIRINATH S	/	/	/	/	/	/	/	/	/	/	/	/
11	731617205011	GOBIKA M	a	a	/	/	/	/	/	/	/	/	/	/
12	731617205012	GOKULAN S	/	/	/	/	/	/	/	/	/	/	/	/
13	731617205013	HARIPRASATH K	/	/	/	/	/	/	a	a	/	/	/	/
14	731617205014	JESSICA COLLINS J P	/	/	/	/	/	/	/	/	/	/	/	/
15	731617205015	JOSHUA DANIEL B	/	/	/	/	/	/	/	/	/	/	/	/
16	731617205016	JOTHEESWARAN R	/	/	/	/	/	/	/	/	/	/	/	/
17	731617205017	KALAI KANNAN S	a	a	a	a	a	a	a	a	a	a	a	a
18	731617205018	KALIDASS R	/	/	/	/	/	/	/	/	/	/	/	/
19	731617205019	KANNAN P	/	/	/	/	/	/	a	/	/	/	/	/
20	731617205021	KARTHIK T	a	a	/	/	/	/	a	a	/	/	/	/
21	731617205022	KARTHIKEYAN M	/	/	/	/	/	/	/	/	/	/	/	/
22	731617205023	KAVIN I G	a	a	a	a	a	a	a	a	a	a	a	a
23	731617205024	KEERTHIVARMA K S	/	/	/	/	/	/	/	/	/	/	/	/
24	731617205025	LAKSHMANAN R	/	/	/	/	/	/	/	/	/	/	/	/
25	731617205026	MANIKANDAN A	/	/	/	/	/	/	a	a	/	/	/	/
26	731617205027	MOUNISH G	a	a	/	/	/	/	/	/	/	/	/	/
27	731617205028	MUKESH KANNA R	/	/	/	/	/	/	/	/	/	/	/	/
28	731617205029	MUKESHKANNAN T	a	a	a	a	a	a	a	a	a	a	a	a
29	731617205030	NANDHINI S	/	/	/	/	/	/	/	/	/	/	/	/
30	731617205031	NATHIYA V	/	/	/	/	/	/	/	/	/	/	/	/
31	731617205032	NAVEEN KUMAR G (30-12-1999)	/	/	/	/	/	/	a	a	/	/	/	/
32	731617205033	NAVEEN KUMAR G (14-06-2000)	a	a	/	/	/	/	/	/	/	/	/	/
33	731617205034	NIRMAL KUMAR S	/	/	/	/	/	/	/	/	/	/	/	/
34	731617205035	PAVITHRA S	/	/	/	/	/	/	a	a	/	/	a	a

PRINCIPAL,
K. S. R. INSTITUTE FOR
ENGINEERING AND TECHNOLOGY,
K. S. R. KALVI NAGAR,
TIRUCHENGODE-637 215,
NAMAKKAL Dt, TAMIL NADU.

Trainng Date			11.06.18		12.06.18		13.06.18		14.06.18		25.06.18		26.06.18	
S. No	Reg No	Name	FN	AN	FN	AN	FN	AN	FN	AN	FN	AN	FN	AN
35	731617205036	PRIYADHARSHINI P	/	/	/	/	a	a	a	a	a	a	/	/
36	731617205037	RAGU G	a	a	/	/	/	/	/	/	/	/	/	/
37	731617205038	RAJARAVEENDHAR G R	/	/	/	/	/	/	a	a	/	/	/	/
38	731617205039	SAANTHOSHBALAJI S N	/	/	a	a	/	/	/	/	/	/	/	/
39	731617205040	SANDHIYA G	/	/	/	/	/	/	/	/	/	/	/	/
40	731617205041	SANTHOSH KUMAR R	/	/	/	/	/	/	/	/	a	a	/	/
41	731617205042	SARAN V	/	/	/	/	/	/	/	/	/	/	/	/
42	731617205043	SATHAM M	/	/	a	a	/	/	/	/	/	/	/	/
43	731617205044	SATHISHKUMAR V	/	/	/	/	a	a	/	/	/	/	/	/
44	731617205045	SELVAMALAR P	/	/	/	/	/	/	a	a	/	/	/	/
45	731617205046	SHAILAA P M	/	/	/	/	/	/	/	/	a	a	/	/
46	731617205047	SHIVANI N	a	a	/	/	/	/	/	/	/	/	/	/
47	731617205048	SIVASANKARI R	/	/	/	/	/	/	/	/	/	/	/	/
48	731617205049	SREEMATHI INDRA S	/	/	/	/	a	a	a	a	/	/	/	/
49	731617205050	SRIRAM S	/	/	a	a	/	/	/	/	/	/	/	/
50	731617205051	THANESSHWARAN Y G	/	/	/	/	/	/	/	/	a	/	/	/
51	731617205052	THUSMEENA K R	/	/	/	/	/	/	/	/	/	/	/	/
52	731617205053	VENKATESHWARAN S	/	/	/	/	a	a	a	a	/	/	/	/
53	731617205054	VIMALRAJ G	/	/	a	a	/	/	/	/	/	/	/	/
54	731617205055	VINOTHINI R	/	/	/	/	/	/	/	/	/	/	/	/
PRESENT														
ABSENT														
PERMISSION														
OD														

PRINCIPAL,
K. S. R. INSTITUTE FOR
ENGINEERING AND TECHNOLOGY,
K. S. R. KALVI NAGAR
TIRUCHENAI
MADE BY: [unclear]

K S R INSTITUTE FOR ENGINEERING AND TECHNOLOGY, Tiruchengode

Training and Placement Cell

MECH A - Internal Basic Communication, Aptitude & Programming In C Training Attendance

BATCH : 2017 - 2021

Academic Year: 2018 - 2019

Training Topics			Programming Skills in C				Aptitude Skills				Communication Skills			
Trainer			Prakasam AP/CSE				Prof.M.S.Vijayaraj HoD/Maths				Dr.C.Muhuntarajan HoD/Eng			
Training Date			13.06.18		14.06.18		18.06.18		19.06.18		02.07.18		03.07.18	
S. No	Reg No	Name	FN	AN	FN	AN	FN	AN	FN	AN	FN	AN	FN	AN
1	731617114001	AADHI VISHWANATH M	/	/	/	/	/	/	/	/	/	/	/	/
2	731617114002	AJITH R	/	/	/	/	/	/	/	/	/	/	/	/
3	731617114003	ARAVIND S R	/	/	/	/	/	/	/	/	/	/	/	/
4	731617114004	ARUNESH J	/	/	/	/	/	/	/	/	/	/	/	/
5	731617114005	ARUN KUMAR S	/	/	/	/	/	/	/	/	a	a	/	/
6	731617114006	ARUN KUMAR T	/	/	/	/	/	/	/	/	/	/	/	/
7	731617114007	ARUN PRABAKARAN J	/	/	/	/	/	/	/	/	/	/	/	/
8	731617114008	ASWANTH KUMAR K	/	/	a	a	/	/	/	/	/	/	/	/
9	731617114009	ASWIN M	/	/	/	/	/	/	/	/	/	/	/	/
10	731617114010	BALAJI S	/	/	/	/	/	/	/	/	/	/	/	/
11	731617114011	BHAGAVATHI PERUMAL G	/	/	/	/	/	/	/	/	/	/	/	/
12	731617114012	BHARANIDHARAN R	/	/	/	/	/	/	/	/	/	/	/	/
13	731617114013	BOOPATHI S	/	/	/	/	/	/	/	/	/	/	/	/
14	731617114014	BOOPATHIRAJA M	/	/	/	/	/	/	/	/	/	/	/	/
15	731617114015	BUVANESVARAN S	/	/	/	/	/	/	/	/	/	/	/	/
16	731617114016	CHANDRU K	/	/	/	/	/	/	/	/	/	/	/	/
17	731617114017	CHANDRU M	/	/	/	/	/	/	/	/	/	/	/	/
18	731617114018	CHANDRU S	/	/	/	/	/	/	/	/	/	/	/	/
19	731617114019	DEEPAK K	/	/	/	/	/	/	/	/	/	/	/	/
20	731617114020	DHARANKUMAR S	/	/	/	/	/	/	/	/	/	/	/	/
21	731617114021	DHARSHAN C M	/	/	/	/	/	/	/	/	/	/	/	/
22	731617114022	DINESHKUMAR D	/	/	/	/	/	/	/	/	/	/	/	/
23	731617114023	DINESHKUMAR R	/	/	/	/	/	/	/	/	/	/	/	/
24	731617114024	DIVAGAR S (Discontinue)	a	a	a	a	a	a	a	a	a	a	a	a
25	731617114026	GOBIRAJ R	/	/	/	/	/	/	/	/	/	/	/	/
26	731617114027	GOKULNATH K	/	/	/	/	/	/	/	/	/	/	/	/
27	731617114028	GOKULPRASANTH M	/	/	/	/	/	/	/	/	/	/	/	/
28	731617114029	GOKULRAJ B	/	/	/	/	/	/	/	/	/	/	/	/
29	731617114030	GOVINDHARASU R	/	/	/	/	/	/	/	/	/	/	/	/
30	731617114031	GOWTHAM KUMAR T	/	/	/	/	/	/	/	/	/	/	/	/
31	731617114032	GUNASEELAN C	/	/	/	/	/	/	/	/	/	/	/	/
32	731617114033	HARIHARAN G	/	/	/	/	/	/	/	/	/	/	/	/
33	731617114034	HARIHARAN PR	a	a	a	a	p	p	/	/	a	a	a	a
34	731617114035	HARIPRASATH P	/	/	/	/	/	/	/	/	/	/	/	/



PRINCIPAL,
K. S. R. INSTITUTE FOR
ENGINEERING AND TECHNOLOGY,
K. S. R. KALVI NAGAR,
TIRUCHENGODE-637 215,
TAMIL NADU.

Training Date			13.06.18		14.06.18		18.06.18		19.06.18		02.07.18		03.07.18	
S. No	Reg No	Name	FN	AN	FN	AN	FN	AN	FN	AN	FN	AN	FN	AN
35	731617114036	HARIRAM B	/	/	/	/	/	/	/	/	/	/	/	/
36	731617114037	INDIRAJITH M	/	/	/	/	/	/	/	/	/	/	/	/
37	731617114038	JAGATHESHWARAN N	/	/	a	a	/	/	/	/	/	/	/	/
38	731617114039	KAMALESH T	/	/	/	/	/	/	/	/	/	/	/	/
39	731617114040	KARTHICK R	/	/	/	/	/	/	/	/	/	/	/	/
40	731617114041	KARTHIK A S	/	/	/	/	/	/	/	/	/	/	/	/
41	731617114042	KARTHIKEYAN S	/	/	/	/	/	/	/	/	/	/	/	/
42	731617114043	KARTHIKEYAN T	/	/	/	/	/	/	/	/	/	/	/	/
43	731617114044	KARUPPAIAH K	/	/	/	/	/	/	/	/	/	/	/	/
44	731617114045	KATHIRVEL M	/	/	/	/	/	/	/	/	/	/	/	/
45	731617114046	KAVIN M	/	/	/	/	/	/	/	/	/	/	/	/
46	731617114047	KAVIN M	/	/	/	/	/	/	/	/	/	/	/	/
47	731617114048	KAVINKUMAR C	/	/	/	/	/	/	/	/	/	/	/	/
48	731617114049	KAVIRAJ M	/	/	/	/	/	/	/	/	/	/	/	/
49	731617114050	KIRUBAKARAN K	/	/	/	/	/	/	/	/	/	/	/	/
50	731617114051	KIRUBAKARAN K	/	/	/	/	/	/	/	/	/	/	/	/
51	731617114052	LOGESH M	/	/	/	/	/	/	/	/	/	/	/	/
52	731617114053	MADESH K	/	/	/	/	/	/	/	/	/	/	/	/
53	731617114054	MANIKANDAN R	/	/	/	/	/	/	/	/	/	/	/	/
54	731617114055	MANOJ N	/	/	/	/	/	/	/	/	/	/	/	/
55	731617114056	MEIYANANDHAN V	/	/	/	/	/	/	/	/	/	/	/	/
56	731617114057	MOHAMED ABBAS M	/	/	/	/	/	/	/	/	/	/	/	/
PRESENT			54	54	50	50	/	/	55	55	54	54	52	52
ABSENT			1	1	3	3	0	0	0	0	1	1	-	-
PERMISSION			0	0	0	0	0	0	-	-	-	-	3	3
OD			0	0	0	0	1	-	-	-	-	-	-	-

PRINCIPAL.
K. S. R. INSTITUTE FOR
ENGINEERING AND TECHNOLOGY,
K. S. R. KALVI NAGAR,
TIRUCHENGODE-637 215,
NAMAKKAL DI. TAMIL NADU.

Training and Placement Cell

CSE - Internal Basic Communication, Aptitude & Programming In C Training Attendance

BATCH : 2017 - 2021

Academic Year: 2018 - 2019

Training Topics			Programming Skills in C				Communication Skills				Aptitude Skills			
Trainer			Sharmila AP/CSE				Dr.C.Muhuntarajan HoD/English				Prof.M.S.Vijayaraj HoD/Maths			
Training Date			11.06.18		12.06.18		9.06.18 13.06.18		10.06.18 14.06.18		21.06.18		22.06.18	
S. No	Reg No	Name	FN	AN	FN	AN	FN	AN	FN	AN	FN	AN	FN	AN
1	731617104001	ABINAYA S	a	a	l	l	l	l	l	l	l	l	l	l
2	731617104002	AGILAN R	a	a	l	l	l	l	l	l	l	l	l	l
3	731617104003	AKKIRAJU-SAI-GHARAN	a	a	l	l	l	l	l	l	l	l	l	l
4	731617104004	ARUN KUMAR N	l	l	a	a	l	l	l	l	l	l	a	a
5	731617104005	BABU R	l	l	l	l	a	a	l	l	a	a	l	l
6	731617104006	BOOPALAN V	a	a	l	l	l	l	l	l	l	l	l	l
7	731617104007	CHOWMIYA S B	l	l	a	a	l	l	l	l	l	l	a	a
8	731617104008	DEEPAK KUMAR J	a	a	l	l	l	l	l	l	a	a	l	l
9	731617104009	DERIL CHARLESS K	l	l	l	l	a	a	l	l	l	l	l	l
10	731617104010	DHARSHINI P	l	l	a	a	l	l	l	l	l	l	l	l
11	731617104011	DINESHKUMAR K (03-11-1999)	l	l	l	l	l	l	l	l	l	l	l	l
12	731617104012	DINESHKUMAR K (25-02-2000)	l	l	l	l	l	l	a	a	l	l	l	l
13	731617104013	ELANGO M	l	l	l	l	l	l	l	l	l	l	l	l
14	731617104014	GAYATHIRI M (19-05-2000)	a	a	l	l	l	l	l	l	l	l	l	l
15	731617104015	GAYATHIRI M (19-10-2000)	l	l	a	a	l	l	l	l	l	l	l	l
16	731617104016	GOWTHAM G	l	l	l	l	l	l	a	a	a	a	l	l
17	731617104017	GUNA M	a	a	l	l	l	l	l	l	l	l	l	l
18	731617104018	HARIHARAN S	l	l	l	l	a	a	l	l	l	l	a	a
19	731617104019	HARI KUMAR S	a	a	a	a	l	l	l	l	l	l	l	l
20	731617104020	HARISH P	l	l	l	l	l	l	l	l	a	a	l	l
21	731617104021	KAILASH K	l	l	l	l	l	l	a	a	l	l	l	l
22	731617104022	KARTHIKEYAN S	a	a	l	l	l	l	l	l	l	l	l	l
23	731617104023	KESAVAN S	l	l	a	a	l	l	l	l	l	l	l	l
24	731617104024	KISHOR P	l	l	l	l	l	l	l	l	l	l	a	a
25	731617104025	KOTEESHWARAN P N	a	a	l	l	l	l	l	l	l	l	l	l
26	731617104026	KRISHNAMOORTHY S	l	l	l	l	l	l	l	l	a	a	l	l
27	731617104027	MANORANJITH M	l	l	a	a	l	l	l	l	l	l	l	l
28	731617104028	MARIMUTHU R	a	a	a	a	l	l	l	l	l	l	l	l
29	731617104029	MENAGA T	l	l	l	l	a	a	l	l	l	l	l	l
30	731617104030	MOHAMED ABI VAKAAS S	l	a	l	l	l	l	l	l	l	l	l	l
31	731617104031	MOHANAPREYA N	a	a	l	l	l	l	l	l	l	l	l	l
32	731617104032	MONISH D	a	a	l	l	l	l	l	l	l	l	l	l
33	731617104033	MURALIDHARAN A	l	l	a	a	l	l	l	l	l	l	l	l
34	731617104034	POOJA M	l	l	l	l	l	l	l	l	l	l	a	a

PRINCIPAL,
K. S. R. INSTITUTE FOR
ENGINEERING AND TECHNOLOGY,
K. S. R. KALVI NAGAR,
TIRUCHENGODE-637 215,
NAMAKKAL Dt, TAMIL NADU.

Trainng Date			11.06.18		12.06.18		13.06.18		14.06.18		21.06.18		22.06.18	
S. No	Reg No	Name	FN	AN	FN	AN	FN	AN	FN	AN	FN	AN	FN	AN
35	731617104035	POOJA SHREE K	/	a	a	a	/	/	/	/	/	/	/	/
36	731617104036	POOVARASAN S	/	/	/	/	/	/	a	a	/	/	/	/
37	731617104037	PRAKASH V	/	a	/	/	/	/	/	/	/	/	/	/
38	731617104038	PRASANTH N	/	/	a	a	/	/	/	/	a	a	/	/
39	731617104039	PRASANTH T	/	/	/	/	/	/	/	/	/	/	/	/
40	731617104040	PURUSOTHAMAN R	a	a	/	/	/	/	/	/	/	/	/	/
41	731617104041	RAJA SARAVANAN N S	/	/	/	/	/	/	/	/	a	a	/	/
42	731617104042	SANGEETHA M	/	/	a	a	/	/	/	/	/	/	/	/
43	731617104043	SANTHOSHKUMAR A	a	a	/	/	/	/	/	/	/	/	/	/
44	731617104044	SATHEESHKUMAR THANGAVEL	/	/	/	/	a	a	/	/	/	/	a	a
45	731617104045	SHARMILA A	/	/	a	a	/	/	/	/	/	/	/	/
46	731617104046	SNEHA P	a	a	/	/	/	/	/	/	/	/	/	/
47	731617104047	SOUNDHAR P	/	/	/	/	/	/	/	/	a	a	/	/
48	731617104048	SURYA K	/	/	/	/	/	/	/	/	/	/	/	/
49	731617104049	TAMILARASU K	Discontinued											
50	731617104050	VAISHNAVI V	/	/	/	/	/	/	a	a	/	/	/	/
51	731617104051	VALENTEENA COLLINS J P	a	a	/	/	/	/	/	/	/	/	/	/
52	731617104052	VEERALAKSHMI S	/	/	/	/	/	/	/	/	/	/	/	/
53	731617104053	VIGNESH M	/	/	a	a	/	/	/	/	/	/	/	/
54	731617104054	VIGNESH S	a	a	/	/	/	/	/	/	/	/	/	/
55	731617104055	VIJAY S	/	/	/	/	/	/	/	/	a	a	/	/
56	731617104057	YOKESH E	/	/	/	/	/	/	/	/	/	/	a	a
57	731617104058	YUVASHREE R	/	/	a	a	/	/	/	/	/	/	/	/
PRESENT														
ABSENT														
PERMISSION														
OD														

PRINCIPAL.
K. S. R. INSTITUTE FOR
ENGINEERING AND TECHNOLOGY,
K. S. R. KALVI NAGAR,
TIRUCHENGODE-637 215,
NAMAKKAL DI, TAMIL NADU.

Training Topics			Programming Skills in C				Communication Skills				Aptitude Skills			
Trainer			D. Balakrishnan AP/IT				Dr.C.Muhuntarajan HoD/Eng				Prof.M.S.Vijayaraj HoD/Maths			
Trainng Date			11.06.18		12.06.18		21.06.18		22.06.18		25.06.18		26.06.18	
S. No	Reg No	Name	FN	AN	FN	AN	FN	AN	FN	AN	FN	AN	FN	AN
1	731617105001	ARUL M	/	/	/	/	/	/	/	/	/	/	/	/
2	731617105002	ASHA R	a	/	a	a	/	/	/	/	/	/	/	/
3	731617105003	BALAJI S	/	/	/	/	a	a	/	/	/	/	/	/
4	731617105004	BHARATH S	/	/	a	a	/	/	/	/	/	/	/	/
5	731617105005	DINESH C	a	a	/	/	/	/	/	/	/	/	/	/
6	731617105006	DINESH KUMAR T	/	/	/	/	/	/	/	/	/	/	/	/
7	731617105007	EZHILAN T	a	a	a	a	Discontinue							
8	731617105008	GOWTHAM S P	/	/	/	/	/	/	/	/	/	/	/	/
9	731617105009	GUGANESH R	/	/	/	/	/	/	/	/	/	/	/	/
10	731617105010	HARI S R	a	a	/	/	a	a	/	/	/	/	/	/
11	731617105011	HEMALATHA S	/	/	a	a	/	/	a	a	/	/	/	/
12	731617105012	JAYASURYA K	/	/	/	/	/	/	/	/	/	/	/	/
13	731617105013	JEEVANANDAM T	a	a	/	/	/	/	/	/	/	/	/	/
14	731617105014	JEEVITHA G	/	/	/	/	/	/	a	a	/	/	/	/
15	731617105015	JEGATHKUMAR S	/	/	/	/	/	/	/	/	/	/	/	/
16	731617105016	KAMALAHASAN G	/	/	/	/	/	/	/	/	/	/	/	/
17	731617105017	KARTHIKEYAN M	/	/	a	a	/	/	a	a	/	/	/	/
18	731617105018	KAVINKUMAR M	/	/	/	/	/	/	/	/	/	/	/	/
19	731617105019	KAVIN MUTHU KUMAR S	a	a	/	/	/	/	/	/	/	/	/	/
20	731617105020	KIRUBAKAR S	/	/	/	/	/	/	/	/	/	/	/	/
21	731617105021	LOGESWARAN C	/	/	a	a	/	/	/	/	/	/	/	/
22	731617105022	MANJUPRIYA M	/	/	/	/	/	/	/	/	a	a	/	/
23	731617105023	MANOJ KUMAR S	/	/	/	/	/	/	/	/	/	/	/	/
24	731617105024	MOHAN T	a	a	/	/	/	/	/	/	a	a	/	/
25	731617105025	NANDAKUMAARAN S	/	/	/	/	/	/	/	/	/	/	/	/
26	731617105027	PARAMASIVAM R	/	/	a	a	/	/	/	/	/	/	/	/
27	731617105028	PERARIVU EZHIL ARASAN T	/	/	/	/	/	/	/	/	/	/	/	/
28	731617105029	POOVARASAN J	/	/	a	a	/	/	/	/	/	/	/	/
29	731617105030	PRASATH S	a	a	a	a	a	a	a	a	a	a	a	a
30	731617105031	PRAVEEN KUMAR A	/	/	/	/	/	/	/	/	/	/	/	/
31	731617105032	PRAVEEN KUMAR M	/	/	/	/	/	/	/	/	/	/	/	/
32	731617105033	RAJAT KUMAR	a	a	a	a	/	/	a	a	/	/	/	/
33	731617105034	RAMYA A	/	/	/	/	/	/	/	/	/	/	/	/
34	731617105035	RAMYA P	/	/	/	/	/	/	/	/	/	/	/	/

PRINCIPAL.
K. S. R. INSTITUTE FOR
ENGINEERING AND TECHNOLOGY,
K. S. R. KALVI NAGAR,
TIRUCHENGODE-637 215,
NAMAKKAL DI, TAMIL NADU.

Training Topics			Communication Skills				Programming Skills in C				Aptitude Skills			
Trainer			Dr.C.Muhuntarajan HoD/Eng				K G Lavanya AP/IT				Prof.M.S.Vijayaraj HoD/Maths			
Trainng Date			01.06.18		02.06.18		18.06.18		19.06.18		28.06.18		29.06.18	
S. No		Name	FN	AN	FN	AN	FN	AN	FN	AN	FN	AN	FN	AN
1	731617106042	NAVEEN L	/	/	/	/	/	/	/	/	/	/	/	/
2	731617106043	NAVEEN S S	/	/	/	/	/	/	/	/	/	/	a	a
3	731617106045	PARKAVI P	/	/	/	/	/	/	/	/	/	/	/	/
4	731617106046	PARKAVI S	/	/	/	/	/	/	/	/	/	/	/	/
5	731617106047	PAVITHRA T	/	/	/	/	/	/	/	/	/	/	/	/
6	731617106048	PREMELA R	/	/	/	/	/	/	/	/	/	/	/	/
7	731617106049	PRIYA R	/	/	/	/	/	/	a	a	/	/	/	/
8	731617106050	PRIYANKA V	a	a	/	/	/	/	/	/	/	/	/	/
9	731617106051	RAGHURAMACHANDIRAN V	/	/	/	/	/	/	/	/	/	/	/	/
10	731617106052	RAMYA S	/	/	/	/	/	/	/	/	/	/	/	/
11	731617106053	RANJITH M	/	/	/	/	/	/	/	/	/	/	/	/
12	731617106054	RESHMA K	/	/	/	/	a	a	/	/	/	/	/	/
13	731617106055	RUBAN PRASAD J	/	/	/	/	/	/	/	/	/	/	/	/
14	731617106056	SANDHIYA K	/	/	/	/	/	/	/	/	a	a	/	/
15	731617106057	SANTHIYA T	/	/	/	/	/	/	/	/	/	/	/	/
16	731617106058	SANTHIYA Y	/	/	/	/	/	/	/	/	/	/	/	/
17	731617106059	SANTHOSH K	/	/	/	/	/	/	/	/	/	/	/	/
18	731617106060	SHALINI V	/	/	/	/	/	/	a	a	/	/	/	/
19	731617106061	SHANMATHI M M	/	/	/	/	/	/	/	/	/	/	/	/
20	731617106062	SHARUMATHI S	/	/	/	/	/	/	/	/	/	/	/	/
21	731617106063	SINDUJA K	/	/	/	/	/	/	/	/	/	/	/	/
22	731617106064	SIVASANKARAN K	a	/	/	/	/	/	/	/	/	/	/	/
23	731617106065	SOFIA A	/	/	/	/	a	a	/	/	/	/	/	/
24	731617106066	SOWMIYA G V	/	/	/	/	/	/	/	/	/	/	/	/
25	731617106067	SREEMATHI G	/	/	/	/	/	/	/	/	/	/	/	/
26	731617106068	SRIDHARAN M	/	/	/	/	/	/	/	/	/	/	/	/
27	731617106069	SRINIVASAN A	/	/	/	/	/	/	/	/	/	/	/	/
28	731617106070	SRINIVASAN S R	/	/	/	/	/	/	a	/	/	/	/	/
29	731617106071	SRI RANJANI S	/	/	/	/	/	/	/	/	/	/	/	/
30	731617106073	SUBASH K	/	/	/	/	/	/	/	/	/	/	/	/
31	731617106074	SUDHA G	/	/	/	/	/	/	/	/	/	/	/	/
32	731617106075	SUKHESAN C	/	/	/	/	a	a	/	/	/	/	/	/
33	731617106076	SURESH K	/	/	/	/	/	/	/	/	/	/	/	/
34	731617106077	SURYAPRIYA K	/	/	/	/	/	/	/	/	/	/	/	/
35	731617106078	SUSHMITHA A	/	/	/	/	/	/	/	/	/	/	/	/

PRINCIPAL,
K. S. R. INSTITUTE FOR
ENGINEERING AND TECHNOLOGY,
K. S. R. KALVI NAGAR,
TIRUCHENGODE-637 215
NAMAKKAL Dt, TAMIL NADU

Training Date			01.06.18		02.06.18		18.06.18		19.06.18		28.06.18		30.06.18	
S. No		Name	FN	AN	FN	AN	FN	AN	FN	AN	FN	AN	FN	AN
36	731617106079	SWEETLIN JOSHVA A	/	/	/	/	/	/	/	/	/	/	/	/
37	731617106080	SWETHA G P	/	/	/	/	/	/	/	/	/	/	/	/
38	731617106081	TAMILZHAGAN G	/	/	a	#	/	/	/	/	/	/	/	/
39	731617106082	TEJASWINI S	/	/	/	/	/	/	/	/	/	/	/	/
40	731617106083	THARUN KUMAR K	/	/	/	/	/	/	/	/	/	/	/	/
41	731617106084	THIYAGU M	/	/	/	/	/	/	/	/	/	/	/	/
42	731617106085	UDAYAKUMAR R	/	/	/	/	/	/	/	/	/	/	/	/
43	731617106086	YASODHA P	/	/	/	/	/	/	/	/	/	/	/	/
44	731617106087	YUVANSANKAR K	/	/	/	/	/	/	/	/	/	/	/	/
45	731617106088	ZUBAIR M	/	/	a	a	/	/	/	/	/	/	/	/
PRESENT			43	44	44	44	4	039	44	44	44	44	44	44
ABSENT			2	1	1	1	2	3	#	#	#	#	#	#
PERMISSION			-	-	-	-	3	3	+	+	+	+	+	+
OD			-	-	-	-	-	-	+	+	+	+	+	+

PRINCIPAL,
K. S. R. INSTITUTE FOR
ENGINEERING AND TECHNOLOGY,
K. S. R. KALVI NAGAR,
TIRUCHENGODE-637 215,
NAMAKKAL DI, TAMIL NADU.

Training Topics			Programming Skills in C				Communication Skills				Aptitude Skills			
Trainer			Sathiya Priya AP/CSE				Dr.C.Muhuntarajan HoD/Eng				Prof.M.S.Vijayaraj HoD/Maths			
Training Date			13.06.18		14.06.18		18.06.18		20.06.18		03.07.18		04.07.18	
S. No	Reg No	Name	FN	AN	FN	AN	FN	AN	FN	AN	FN	AN	FN	AN
1	731617114058	MOHANARAJ C	a	a	/	/	/	/	/	/	/	/	/	/
2	731617114059	MONISH KANNA M	/	/	/	/	/	/	/	/	/	/	/	/
3	731617114060	MUNESWARAN D	/	/	/	/	/	/	a	a	a	a	/	/
4	731617114061	NANDHAKUMAR G	/	/	/	/	/	/	/	/	/	/	/	/
5	731617114062	NARESH M	/	/	/	/	/	/	/	/	/	/	a	a
6	731617114063	NAVEEN M	/	/	a	a	/	/	/	/	/	/	/	/
7	731617114064	NAVEEN V	/	/	/	/	/	/	/	/	/	/	/	/
8	731617114065	NIKHIL S	/	/	/	/	a	a	/	/	/	/	/	/
9	731617114066	NITHISH M	a	a	/	/	/	/	/	/	/	/	/	/
10	731617114067	PAVITHRAN G	/	/	/	/	/	/	a	a	a	a	/	/
11	731617114069	PRADEEP N	/	/	a	a	/	/	/	/	/	/	a	a
12	731617114070	PRADHAP R	/	/	/	/	/	/	/	/	/	/	/	/
13	731617114071	PRAGATHEESWAR E	/	/	/	/	/	/	/	/	/	/	/	/
14	731617114072	PRASATH R	/	/	/	/	/	/	/	/	/	/	/	/
15	731617114073	PRATHIYUMANAN M	/	/	/	/	/	/	/	/	/	/	/	/
16	731617114074	PRAVEEN H	/	/	/	/	a	a	/	/	/	/	/	/
17	731617114075	PRAVEENKUMAR V	a	a	/	/	/	/	/	/	/	/	/	/
18	731617114076	PRAVEEN KUMAR S	/	/	/	/	/	/	a	a	a	a	/	/
19	731617114077	PREMRAJ S	/	/	/	/	/	/	/	/	/	/	/	/
20	731617114078	RAHUL V	/	/	/	/	/	/	/	/	/	/	/	/
21	731617114079	RAMKUMAR B	/	/	/	/	/	/	/	/	/	/	/	/
22	731617114080	RANJITHKUMAR K	/	/	/	/	/	/	/	/	/	/	/	/
23	731617114081	SABARINATHAN S	/	/	/	/	/	/	/	/	/	/	a	a
24	731617114082	SAKTHIVEL P	/	/	/	/	a	a	/	/	/	/	/	/
25	731617114083	SANTHOSHKUMAR G	/	/	/	/	/	/	/	/	/	/	/	/
26	731617114084	SARAN KUMAR D	/	/	/	/	/	/	/	/	/	/	/	/
27	731617114085	SARATH KUMAR M	/	/	/	/	/	/	a	a	/	/	/	/
28	731617114086	SARAVANAA M	/	/	/	/	/	/	/	/	/	/	/	/
29	731617114087	SARAVANAN R	/	/	/	/	/	/	/	/	a	a	/	/
30	731617114088	SASIKARAN S	/	/	/	/	/	/	/	/	/	/	a	a
31	731617114089	SATHISHKUMAR S	/	/	/	/	a	a	/	/	/	/	/	/
32	731617114090	SHAJAHAN S	/	/	/	/	/	/	/	/	/	/	/	/
33	731617114091	SRIDHAR C	/	/	/	/	/	/	/	/	/	/	/	/
34	731617114092	SRIDHARAN R	/	/	/	/	/	/	/	/	/	/	/	/

PRINCIPAL

K. S. R. INSTITUTE FOR
ENGINEERING AND TECHNOLOGY,

K. S. R. KALVI NAGAR,

TIRUCHENGODE-637 215,

TAMIL NADU.

Trainng Date			13.06.18		14.06.18		18.06.18		20.06.18		03.07.18		04.07.18	
S. No	Reg No	Name	FN	AN	FN	AN	FN	AN	FN	AN	FN	AN	FN	AN
35	731617114093	SURENDHAR P	/	/	/	/	/	/	/	/	/	/	/	/
36	731617114094	SURESHKUMAR A	/	/	/	/	/	/	/	/	/	/	/	/
37	731617114095	SURESHMOORTHY P	2	2	/	/	/	/	/	/	/	/	/	/
38	731617114096	SURYAMOORTHY R	/	/	/	/	/	/	/	/	/	/	a	a
39	731617114098	TAMILSELVAN V	/	/	/	/	2	2	/	/	/	/	/	/
40	731617114099	THAMIL SELVAM B	/	/	/	/	/	/	/	/	/	/	/	/
41	731617114100	THIRUPATHI M	/	/	/	/	/	/	a	a	/	/	a	a
42	731617114101	THULASI RAMAN R	2	2	/	/	/	/	/	/	/	/	/	/
43	731617114102	VIGNESH R	/	/	a	a	/	/	/	/	/	/	/	/
44	731617114103	VIGNESHWARAN S	/	/	/	/	/	/	/	/	/	/	/	/
45	731617114104	VIJAYAKUMAR C	/	/	/	/	a	a	/	/	/	/	a	a
46	731617114105	VINITH D	/	/	/	/	/	/	/	/	/	/	/	/
47	731617114106	VINOTH KUMAR T	/	/	/	/	/	/	a	a	/	/	/	/
48	731617114107	YASWANTHKARTHIK S	/	/	2	2	/	/	/	/	/	/	a	a
49	731617114108	YOGESH N	/	/	/	/	a	a	/	/	/	/	/	/
50	731617114301	R. Abhishek	/	/	/	/	/	/	/	/	/	/	/	/
51	731617114302	Dineshwaran	a	a	/	/	/	/	/	/	/	/	/	/
52	731617114303	M.Hariprasad	/	/	/	/	/	/	/	/	/	/	/	/
53	731617114304	E.Kannan	/	/	/	/	2	2	/	/	/	/	a	a
54	731617114305	V.Manikandan	/	/	/	/	/	/	2	2	/	/	/	/
55	731617114306	Nantha kumar	/	/	/	/	/	/	/	/	/	/	/	/
PRESENT			42	42	47	47	42	42	46	46	48	48	46	46
ABSENT			4	4	3	3	6	6	6	6	5	5	9	9
PERMISSION			4	4	1	1	3	3	3	3	2	2	-	-
OD			-	-	-	-	-	-	-	-	-	-	-	-

PRINCIPAL,
K. S. R. INSTITUTE FOR
ENGINEERING AND TECHNOLOGY,
K. S. R. KALVA NAGAR,
TIRUCHENGODE-637 215,
NAMAKKAL DISTRICT, TAMIL NADU.

Internal Basic Communication, Aptitude & Programming In C Training Attendance

BATCH: 2017 - 2021

ACADEMIC YEAR: 2018 - 2019 (ODD)

DATE: 11.06.2018

Fore Noon session

S.NO	BRANCH	STRENGTH	PRESENT	ABSENT	Leave
1	CSE	57	39	17	1
2	ECE - A	40	32	8	0
3	EEE	52	43	9	0
4	IT	54	43	11	0
Total		203	157	45	1

After Noon Session

S.NO	BRANCH	STRENGTH	PRESENT	ABSENT	PERMISSION
1	CSE	57	37	20	0
2	ECE - A	40	32	8	0
3	EEE	52	44	8	0
4	IT	54	43	11	0
Total		203	156	47	0

F. Kalvi
T&P OFFICER
11/6/18

[Signature]
T&P CO ORDINATOR

[Signature]
PRINCIPAL

[Green Checkmark]
PRINCIPAL,
K. S. R. INSTITUTE FOR
ENGINEERING AND TECHNOLOGY,
K. S. R. KALVI NAGAR,
TIRUCHENGODE-637 215,
NAMAKKAL Dt, TAMIL NADU.

Internal Basic Communication, Aptitude & Programming In C Training Attendance

BATCH: 2017 - 2021

ACADEMIC YEAR: 2018 - 2019 (ODD)

DATE: 12.06.2018

Fore Noon session

S.NO	BRANCH	STRENGTH	PRESENT	ABSENT	Leave
1	CSE	55	40	15	0
2	ECE - A	37	33	4	0
3	EEE	52	40	12	0
4	IT	54	46	8	0
Total		198	159	39	0

After Noon Session

S.NO	BRANCH	STRENGTH	PRESENT	ABSENT	PERMISSION
1	CSE	55	40	15	0
2	ECE - A	37	33	4	0
3	EEE	52	42	10	0
4	IT	54	46	8	0
Total		198	161	37	0

K. Kalvi
T & P OFFICER
12/06/18

T&P CO ORDINATOR
12/06/18

PRINCIPAL
12/06/18

PRINCIPAL
K. S. R. INSTITUTE FOR
ENGINEERING AND TECHNOLOGY,
K. S. R. KALVI NAGAR,
TIRUCHENGODE-637215
NAMAKKAL DISTRICT, TAMIL NADU.

Internal Basic Communication, Aptitude & Programming In C Training Attendance

BATCH: 2017 - 2021

ACADEMIC YEAR: 2018 - 2019 (ODD)

DATE: 13.06.2018

Fore Noon session

S.NO	BRANCH	STRENGTH	PRESENT	ABSENT	Leave
1	IT	54	46	8	0
2	MECH A	55	54	1	0
3	MECH B	50	42	4	4
Total		159	142	13	4

After Noon Session

S.NO	BRANCH	STRENGTH	PRESENT	ABSENT	PERMISSION
1	IT	54	46	8	0
2	MECH A	55	54	1	0
3	MECH B	50	42	4	4
Total		159	142	13	4

Y. Kalvi
T & P OFFICER

[Signature]
T&P CO ORDINATOR

PRINCIPAL

[Signature]
PRINCIPAL,
K. S. R. INSTITUTE FOR
ENGINEERING AND TECHNOLOGY,
K. S. R. KALVI NAGAR,
TIRUCHENGODE-637 215,
NAMAKKAL DI, TAMIL NADU.

Internal Basic Communication, Aptitude & Programming In C Training Attendance

BATCH: 2017 - 2021

ACADEMIC YEAR: 2018 - 2019 (ODD)

DATE: 14.06.2018

Fore Noon session

S.NO	BRANCH	STRENGTH	PRESENT	ABSENT	Leave
1	IT	54	39	15	0
2	MECH A	55	52	3	0
3	MECH B	51	47	3	1
Total		160	138	21	1

After Noon Session

S.NO	BRANCH	STRENGTH	PRESENT	ABSENT	PERMISSION
1	IT	54	39	15	0
2	MECH A	55	52	3	0
3	MECH B	51	47	3	1
Total		160	138	21	1

K. Kalvi
T&P OFFICER'S
14/06/18

[Signature]
T&P CO ORDINATOR
14/06/18

[Signature]
PRINCIPAL

PRINCIPAL,
K. S. R. INSTITUTE FOR
ENGINEERING AND TECHNOLOGY,
K. S. R. KALVI NAGAR,
TIRUCHENGODE-637 215,
NAMAKKAL DI, TAMIL NADU.

Internal Basic Communication, Aptitude & Programming In C Training Attendance

BATCH: 2017 - 2021

ACADEMIC YEAR: 2018 - 2019(ODD)

DATE: 18.06.2018

Fore Noon session

S.NO	BRANCH	STRENGTH	PRESENT	ABSENT	Leave
1	ECE A	37	36	1	0
2	ECE B	45	42	3	0
3	MECH A	55	53/40	0	2
4	MECH B	51	42	6	3
Total		188	173	10	5

After Noon Session

S.NO	BRANCH	STRENGTH	PRESENT	ABSENT	PERMISSION
1	ECE A	37	36	1	0
2	ECE B	45	42	3	0
3	MECH A	55	53/37	0	2
4	MECH B	51	42	6	3
Total		188	173	10	5

T. J. Kalvi
T & P OFFICER
18/6/18

T&P CO ORDINATOR
18/6/18

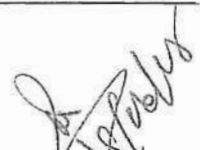
PRINCIPAL

PRINCIPAL,
K. S. R. INSTITUTE FOR
ENGINEERING AND TECHNOLOGY
K. S. R. KALVI NAGAR,
TIRUCHENGODE-637 215,
NAMAKKAL Dt, TAMIL NADU.

TRAINING & PLACEMENT CELL



Internal Basic Communication, Aptitude & Programming In C Training Attendance

BATCH: 2017 - 2021

ACADEMIC YEAR: 2018 - 2019 (ODD)

DATE: 19.06.2018

Fore Noon session

S.NO	BRANCH.	STRENGTH	PRESENT	ABSENT	Leave
1	ECE A	37	35	2	0
2	ECE B	45	40	2	3
3	MECH A	55	55	0	0
Total		137	130	4	3

After Noon Session

S.NO	BRANCH	STRENGTH	PRESENT	ABSENT	Leave
1	ECE A	37	35	2	0
2	ECE B	45	39	3	3
3	MECH A	55	55	0	0
Total		137	129	5	3

Y. Kalith
T & P OFFICER
19/6/18

A. S. S.
T&P CO ORDINATOR
19/6/18

A. S. S.
PRINCIPAL
19/6/18

(Green Checkmark)
PRINCIPAL,
K. S. R. INSTITUTE FOR
ENGINEERING AND TECHNOLOGY,
K. S. R. KALVI NAGAR,
TIRUCHENGODE-637 215,
NAMAKKAL DI, TAMIL NADU.



Internal Basic Communication, Aptitude & Programming In C Training Attendance

BATCH: 2017 - 2021

ACADEMIC YEAR: 2018 - 2019 (ODD)

DATE: 20.06.2018

Fore Noon session

S.NO	BRANCH	STRENGTH	PRESENT	ABSENT	Leave
1	MECH B	55	46	6	3
Total		55	46	6	3

After Noon Session

S.NO	BRANCH	STRENGTH	PRESENT	ABSENT	Leave
1	MECH B	55	46	6	3
Total		55	46	6	3

[Signature]
T & P OFFICER
20/6/18

[Signature]
T&P CO ORDINATOR

[Signature]
PRINCIPAL

[Signature]
PRINCIPAL,
K. S. R. INSTITUTE FOR
ENGINEERING AND TECHNOLOGY,
K. S. R. KALVI NAGAR,
TIRUCHENGODE-637 215,
NAMAKKAL Dt, TAMIL NADU.

Internal Basic Communication, Aptitude & Programming In C Training Attendance

BATCH: 2017 - 2021

ACADEMIC YEAR: 2018 - 2019 (ODD)

DATE: 21.06.2018

Fore Noon session

S.NO	BRANCH	STRENGTH	PRESENT	ABSENT	Leave
1	CSE	55	46	9	0
2	EEE	51	49	1	1
Total		51	49	1	1

After Noon Session

S.NO	BRANCH	STRENGTH	PRESENT	ABSENT	Leave
1	CSE	55	46	9	0
2	EEE	51	49	1	1
Total		51	49	1	1

V. Kalish
T & P OFFICER
21/6/18

[Signature]
21/6/18
T&P CO ORDINATOR

[Signature]
21/6/18
PRINCIPAL

[Signature]
PRINCIPAL
K. S. R. INSTITUTE FOR
ENGINEERING AND TECHNOLOGY,
K. S. R. KALVI NAGAR,
TIRUCHENGODE-637 215,
NAMAKKAL Dt, TAMIL NADU.

Internal Basic Communication, Aptitude & Programming In C Training Attendance

BATCH: 2017 - 2021

ACADEMIC YEAR: 2018 - 2018(ODD)

DATE: 22.06.2018

Fore Noon session

S.NO	BRANCH	STRENGTH	PRESENT	ABSENT	Leave
1	CSE	55	46	7	2
2	EEE	51	46	2	3
Total		51	46	2	3

T & P OFFICER

T&P CO ORDINATOR

PRINCIPAL

PRINCIPAL,
K. S. R. INSTITUTE FOR
ENGINEERING AND TECHNOLOGY,
K. S. R. KALVI NAGAR,
TIRUCHENGODE-637 215,
NAMAKKAL DI, TAMIL NADU.

Internal Basic Communication, Aptitude & Programming In C Training Attendance

BATCH: 2017 - 2021

ACADEMIC YEAR: 2018 - 2019 (ODD)

DATE: 25.06.2018

Fore Noon session

S.NO	BRANCH	STRENGTH	PRESENT	ABSENT	Leave
1	IT	54	46	8	0
2	EEE	51	48	3	0
Total		105	94	11	0

After Noon session

S.NO	BRANCH	STRENGTH	PRESENT	ABSENT	Leave
1	IT	54	47	7	0
2	EEE	51	48	3	0
Total		105	95	10	0

T & P OFFICER

T & P CO ORDINATOR

PRINCIPAL

PRINCIPAL,
K. S. R. INSTITUTE FOR
ENGINEERING AND TECHNOLOGY,
K. S. R. KALVI NAGAR,
TIRUCHENGODE-637 215,
NAMAKKAL DL, TAMIL NADU.

Internal Basic Communication, Aptitude & Programming In C Training Attendance

BATCH: 2017 - 2021

ACADEMIC YEAR: 2018 - 2019 (ODD)

DATE: 26.06.2018

Fore Noon session

S.NO	BRANCH.	STRENGTH	PRESENT	ABSENT	Leave
1	IT	54	49	4	1
2	EEE	51	46	5	0
Total		105	95	9	1

After Noon session

S.NO	BRANCH	STRENGTH	PRESENT	ABSENT	Leave
1	IT	54	49	4	1
2	EEE	51	46	5	0
Total		105	95	9	1

[Handwritten Signature]
T & P OFFICER
26/6/18

[Handwritten Signature]
26/6/18
T&P CO ORDINATOR

[Handwritten Signature]
26/6/18
PRINCIPAL

PRINCIPAL,
K. S. R. INSTITUTE FOR
ENGINEERING AND TECHNOLOGY,
K. S. R. KALVI NAGAR,
TIRUCHENGODE-637 215,
NAMAKKAL Dt, TAMIL NADU.

Internal Basic Communication, Aptitude & Programming In C Training Attendance

BATCH: 2017 - 2021

ACADEMIC YEAR: 2018 - 2019 (ODD)

DATE: 28.06.2018

Fore Noon session

S.NO	BRANCH	STRENGTH	PRESENT	ABSENT	Leave
1	ECE A	37	37	0	0
2	ECE B	45	44	1	0
Total		82	81	1	0

After Noon session

S.NO	BRANCH	STRENGTH	PRESENT	ABSENT	Leave
1	ECE A	37	37	0	0
2	ECE B	45	44	1	0
Total		82	81	1	0

[Handwritten Signature]
T & P OFFICER
28/6/18

[Handwritten Signature]
28/6/18
T&P CO ORDINATOR

[Handwritten Signature]
PRINCIPAL

[Green Stamp]
PRINCIPAL,
K. S. R. INSTITUTE FOR
ENGINEERING AND TECHNOLOGY,
K. S. R. KALVI NAGAR,
TIRUCHENGODE-637 215,
NAMAKKAL DI, TAMIL NADU.

Internal Basic Communication, Aptitude & Programming In C Training Attendance

BATCH: 2017 - 2021

ACADEMIC YEAR: 2018 - 2019 (ODD)

DATE: 29.06.2018

Fore Noon session

S.NO	BRANCH	STRENGTH	PRESENT	ABSENT	Leave
1	ECE A	37	36	1	0
2	ECE B	45	41	2	2
Total		82	77	3	2

After Noon session

S.NO	BRANCH	STRENGTH	PRESENT	ABSENT	Leave
1	ECE A	37	36	1	0
2	ECE B	45	41	2	2
Total		82	77	3	2

[Signature]
T & P OFFICER
29/6/18

[Signature]
T&P CO ORDINATOR
29/6/18

[Signature]
PRINCIPAL
29/6/18

[Green Checkmark]
PRINCIPAL,
K. S. R. INSTITUTE FOR
ENGINEERING AND TECHNOLOGY,
K. S. R. KALVI NAGAR,
TIRUCHENGODE-637 215,
NAMAKKAL Dt, TAMIL NADU.

Internal Basic Communication, Aptitude & Programming In C Training Attendance

BATCH: 2017 - 2021

ACADEMIC YEAR: 2018 - 2019 (ODD)

DATE: 03.07.18

Fore Noon session

S.NO	BRANCH	STRENGTH	PRESENT	ABSENT	Leave
1	MECH A	55	54	1	0
2	MECH B	55	48	5	2
Total		110	102	6	2

After Noon session

S.NO	BRANCH	STRENGTH	PRESENT	ABSENT	Leave
1	MECH A	55	54	1	0
2	MECH B	55	48	5	2
Total		110	102	6	2

[Signature]
T & P OFFICER
3/7/18

[Signature]
T & P CO ORDINATOR
3/7/18

[Signature]
PRINCIPAL
3/7/18

[Signature]
PRINCIPAL,
K. S. R. INSTITUTE FOR
ENGINEERING AND TECHNOLOGY,
K. S. R. KALVI NAGAR,
TIRUCHENGODE-637 215,
NAMAKKAL DI. TAMIL NADU.



Internal Basic Communication, Aptitude & Programming In C Training Attendance

BATCH: 2017 - 2021

ACADEMIC YEAR: 2018 - 2019 (ODD)

DATE: 04.07.2018

Fore Noon session

S.NO	BRANCH	STRENGTH	PRESENT	ABSENT	Leave
1	MECH A	55	52	0	3
2	MECH B	55	46	9	0
Total		110	98	9	3

After Noon session

S.NO	BRANCH	STRENGTH	PRESENT	ABSENT	Leave
1	MECH A	55	52	0	3
2	MECH B	55	46	9	0
Total		110	98	9	3

Y. Kalish
T & P OFFICER

[Signature]
T&P CO ORDINATOR

[Signature]
PRINCIPAL

[Signature]
PRINCIPAL.
K. S. R. INSTITUTE FOR
ENGINEERING AND TECHNOLOGY,
K. S. R. KALVI NAGAR,
TIRUCHENGODE-637 215,
NAMARKAL Dt, TAMIL NADU.

Internal Basic Communication, Aptitude & Programming In C Training Attendance

BATCH: 2017 - 2021

ACADEMIC YEAR: 2018 - 2019 (ODD)

DATE: 01.08.2018

Fore Noon session

S.NO	BRANCH	STRENGTH	PRESENT	ABSENT	Leave
1	ECE B	45	43	2	0
Total		45	43	2	0

After Noon session

S.NO	BRANCH	STRENGTH	PRESENT	ABSENT	Leave
1	ECE B	45	43	1	0
Total		45	43	1	0

BATCH: 2017 - 2021

ACADEMIC YEAR: 2018 - 2019 (ODD)

DATE: 02.08.2018

Fore Noon session

S.NO	BRANCH	STRENGTH	PRESENT	ABSENT	Leave
1	ECE B	45	43	1	0
Total		45	43	1	0

After Noon session

S.NO	BRANCH	STRENGTH	PRESENT	ABSENT	Leave
1	ECE B	45	43	1	0
Total		45	43	1	0

T & P Officer
T & P OFFICER
2/8/18

T & P Coordinator
T&P CO ORDINATOR

Principal
PRINCIPAL

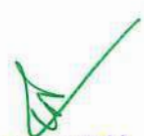
PRINCIPAL,
K. S. R. INSTITUTE FOR
ENGINEERING AND TECHNOLOGY,
K. S. R. KALVI NAGAR,
TIRUCHENGODE-637 215,
NAMAKKAL Dt, TAMIL NADU.

Internal Basic Communication, Aptitude & Programming In C Training Attendance

BATCH: 2017 - 2021

ACADEMIC YEAR: 2018 - 2019 (ODD)

DATE: 09.08.2018

Fore Noon session

S.NO	BRANCH	STRENGTH	PRESENT	ABSENT	Leave
1	CSE	55	50	5	0
Total		55	50	5	0

After Noon session

S.NO	BRANCH	STRENGTH	PRESENT	ABSENT	Leave
1	CSE	55	50	5	0
Total		55	50	5	0

BATCH: 2017 - 2021

ACADEMIC YEAR: 2018 - 2019 (ODD)

DATE: 10.08.2018

Fore Noon session

S.NO	BRANCH	STRENGTH	PRESENT	ABSENT	Leave
1	CSE	55	50	5	0
Total		55	50	5	0

After Noon session

S.NO	BRANCH	STRENGTH	PRESENT	ABSENT	Leave
1	CSE	55	50	5	0
Total		55	50	5	0

V. S. S. S. S.
T & P OFFICER

[Signature]
T & P CO ORDINATOR

[Signature]
PRINCIPAL

PRINCIPAL,
K. S. R. INSTITUTE FOR
ENGINEERING AND TECHNOLOGY,
K. S. R. KALVI NAGAR,
TIRUCHENGODE-637 215,
NAMAKKAL Dt, TAMIL NADU.



TRAINING PROGRAMME FEEDBACK FORM

Name of the Student: Hari Prasad

Branch: B.TECH/IT

Year / Sem: II / 3

4. Name of the Training: Programming Skills in C

5. Name of the Trainer: Nanda Mr. Nandagopal

6. Students rating of Trainers :

S. No.	Date	Subject	Rating (✓)			
			Excellent	Very good	Good	Average
1	11.6.2018	Programming in C			✓	

4. Two positive points about the programme:

It is very useful for all.

It face a complicated questions

5. Suggestions for improvement:

It is useful to improve my programming skills.

Date: 11.6.2018

Signature

R. Hari Prasad



TRAINING PROGRAMME FEEDBACK FORM

Name of the Student: SHIVANI

Branch: IT

Year / Sem: II / III

1. Name of the Training: Basic Programming in C

2. Name of the Trainer: Mr. Nandha Gopal

3. Students rating of Trainers :

S. No.	Date	Subject	Rating (✓)			
			Excellent	Very good	Good	Average
1	11/06/18	Basic in C			✓	

4. Two positive points about the programme:

We regain the knowledge & basis in

C Programming

5. Suggestions for improvement:

Teach with example program based on

concepts

N. Shif.

Date: 11/06/18

Signature



Name of the Student: S. HEMALATHA

Branch: B.E / EEE

Year / Sem: II / III

1. Name of the Training: Programming skills in C

2. Name of the Trainer: D. Balakrishnan

3. Students rating of Trainers :

- 1) Greatest of 3 no.s
- 2) Prime or not
- 3) Factorial
- 4) Table using do while

S. No.	Date	Subject	Rating (✓)			
			Excellent	Very good	Good	Average
1	11-06-18	C-Program (intro) data types, looping, process decision making	✓			

4. Two positive points about the programme: Developing in computer language as problem solving technique

5. Suggestions for improvement: Give more problems to solve

Date: 11-06-18

[Signature]
Signature



Name of the Student: T. EZHILAN

Branch: BE. EEE

Year / Sem: II / III

4. Name of the Training: programming skills in C

5. Name of the Trainer: D. Bala Krishnan

6. Students rating of Trainers :

S. No.	Date	Subject	Rating (✓)			
			Excellent	Very good	Good	Average
1	11.6.2018	C-programming	✓			

4. Two positive points about the programme: Very kind and easy handling us in subject wise

5. Suggestions for improvement: Explicit problems how to solve

Date: 11.6.2018

PRINCIPAL,
K. S. R. INSTITUTE FOR
ENGINEERING AND TECHNOLOGY,
K. S. R. KAVI NAGAR,
TIRUCHENGODE-637 215,
NAMAKKAL DI, TAMIL NADU.

[Signature]
Signature



Name of the Student: P. N. KOTESHWARAN Branch: CSE

Year / Sem: 11 / III

1. Name of the Training: Programming skills in C.

2. Name of the Trainer: SHARMILA N.S

3. Students rating of Trainers :

S. No.	Date	Subject	Rating (✓)			
			Excellent	Very good	Good	Average
1	11.06.18	Basic Programming in 'C'	✓			

4. Two positive points about the programme:

Basic things of the programming was explained clearly.

5. Suggestions for improvement:

Date: 11/6/18

P. N. Koteswaran
Signature



Name of the Student: P. Sneha Branch: CSE

Year / Sem: 11 / III

4. Name of the Training: Programming skills in C.

5. Name of the Trainer: SHARMILA N.S

6. Students rating of Trainers :

S. No.	Date	Subject	Rating (✓)			
			Excellent	Very good	Good	Average
1	11.06.2018	Basic programming in C	✓			

4. Two positive points about the programme:

All ✓ codings are explained step by step by understanding them clearly.

5. Suggestions for improvement:

Give some ✓ program to solve.

Date: 11/6/18

PRINCIPAL,
K. S. R. INSTITUTE FOR
ENGINEERING AND TECHNOLOGY,
K. S. R. KALVI NAGAR,
TIRUCHENGODE-637 215,
NAMAKKAL DI, TAMIL NADU.

P. Sneha
Signature



Name of the Student: P. DINNESH

Branch: BE/ECF

Year / Sem: II / III

1. Name of the Training : APTITUDE SKILLS

2. Name of the Trainer : Mr. VISAYARAJ

3. Students rating of Trainers : 9/10

S. No.	Date	Subject	Rating (√)			
			Excellent	Very good	Good	Average
1	11/06/18	Maths	✓			

4. Two positive points about the programme: *. Own aptitude skill will be improved and we can solve the problems easily.

5. Suggestions for improvement: *. Easy for us to place and clear the aptitude level. More problems can be practised

Date: 11/06/2018

Signature P. Dinnesh



Name of the Student: S. Keerthana

Branch: BE/ECF

Year / Sem: II / 3

4. Name of the Training : Aptitude

5. Name of the Trainer : Mr. Vijayaraj

6. Students rating of Trainers : 8.56

S. No.	Date	Subject	Rating (√)			
			Excellent	Very good	Good	Average
1	11/6/18	Aptitude		✓		

4. Two positive points about the programme: ⇒ It is easy to solve as it involves basic mathematics.

5. Suggestions for improvement: ⇒ It is the basic requirement for all entrance exams. [Nothing]

Date: 11/6/18

Signature [Signature]



TRAINING PROGRAMME FEEDBACK FORM

Name of the Student: THAMIZHSELVAN R Branch: EEE

Year / Sem: II / III

4. Name of the Training: C programming.

5. Name of the Trainer: BALAKRISHNAN

6. Students rating of Trainers :

S. No.	Date	Subject	Rating (√)			
			Excellent	Very good	Good	Average
1	11.6.18, 12-6-18	'C' program Basic		✓		

4. Two positive points about the programme: known about basic 'C' programming.

5. Suggestions for improvement: learn 'C' language

Date: 12.6.18

R. ThamizhSelvan
Signature



TRAINING PROGRAMME FEEDBACK FORM

Name of the Student: Muthulakshmi S Branch: ECB-A

Year / Sem: 2nd / 3rd

1. Name of the Training: APTITUDE

2. Name of the Trainer: Vijay Raj

3. Students rating of Trainers : 9

S. No.	Date	Subject	Rating (√)			
			Excellent	Very good	Good	Average
1	12.6.18	APTITUDE				

4. Two positive points about the programme: He teach very clearly

5. Suggestions for improvement: -

Date: 12.6.18

S. Raj
Signature

PRINCIPAL
K. S. R. INSTITUTE FOR
ENGINEERING AND TECHNOLOGY,
K. S. R. KALVI NAGAR,
TIRUCHENGODE-637 215,
NAMAKKAL DISTRICT, TAMIL NADU.

TRAINING PROGRAMME FEEDBACK FORM

Name of the Student: R. Hosi Hosi Suchan Branch: EEEA

Year / Sem: 2nd / 3rd

4. Name of the Training: VIJAYRAJ (APTITUDE)

5. Name of the Trainer: VIJAYRAJ

6. Students rating of Trainers: 9.5

S. No.	Date	Subject	Rating (√)			
			Excellent	Very good	Good	Average
1	12/6/18	APTITUDE	✓			

4. Two positive points about the programme:

Good planning
Good teaching

5. Suggestions for improvement:

-

Date: 12/6/18

Signature

TRAINING PROGRAMME FEEDBACK FORM

Name of the Student: T. Mohan Branch: EEE

Year / Sem: II / III

1. Name of the Training: c programming basics

2. Name of the Trainer:

3. Students rating of Trainers: Balakrishnan

S. No.	Date	Subject	Rating (√)			
			Excellent	Very good	Good	Average
1	11-06-18	c-Programs			✓	

4. Two positive points about the programme:

1] learnt about c basics

2] learnt basic problem solving technique

5. Suggestions for improvement:

Teach some more basics in c

PRINCIPAL
K. S. R. INSTITUTE FOR
ENGINEERING AND TECHNOLOGY,
K. S. R. KALVI NAGAR,
TIRUCHENGODE-637 215,
NAMAKKAL Dt, TAMIL NADU.

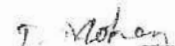
Signature



Name of the Student: N. MOHANAPREYA

Branch: B.E - CSE

Year / Sem: II / III

1. Name of the Training : C Programming

2. Name of the Trainer : N. Sharmila

3. Students rating of Trainers :

S. No.	Date	Subject	Rating (✓)			
			Excellent	Very good	Good	Average
1	12.6.18	C Programming	✓			

4. Two positive points about the programme: Can able to learn the C Programming in detail.

Can able to review and getting thorough in the language

5. Suggestions for improvement:

Extend the classes for one more day.

Date: 12.6.18

N. Mohanap
Signature



Name of the Student: ARUNKUMAR N

Branch: B.E. CSE

Year / Sem: II / 03

4. Name of the Training : C Programming

5. Name of the Trainer : N. Sharmila

6. Students rating of Trainers :

S. No.	Date	Subject	Rating (✓)			
			Excellent	Very good	Good	Average
1	12.6.18	C programming			✓	

4. Two positive points about the programme:

To get clear idea about PRINCIPAL logic of the program

5. Suggestions for improvement:

Want next level programs

teaching base sum, multiplication.

Want next level in programs.

Date: 12.6.18

[Signature]
Signature



Name of the Student: R. Senthilokh Kumar

Branch: B.TECH-IT

Year / Sem: II yr / III sem

1. Name of the Training: Programming in c

functions
structure

2. Name of the Trainer: Nandagopal

3. Students rating of Trainers :

S. No.	Date	Subject	Rating (√)			
			Excellent	Very good	Good	Average
1	12.06.18	Programming in c		✓		

4. Two positive points about the programme: *) we have done most of the programmes
*) level of teaching by staff was good

5. Suggestions for improvement: *) apart from basics, many new and advanced concepts can be taught with practice

Date: 12.06.18

R. Senthilokh
Signature



Name of the Student: M. GIOBIKA

Branch: IT

Year / Sem: II / III

4. Name of the Training: Programming in c

5. Name of the Trainer: Nandagopal

6. Students rating of Trainers :

S. No.	Date	Subject	Rating (√)			
			Excellent	Very good	Good	Average
1	12.06.18	PROGRAMMING IN C		✓		

4. Two positive points about the programme: In this class we got the basic ideas about the programming language. Recalling of the basics made us to get clear ideas which is the beginning to our programming skill.

5. Suggestions for improvement:

Exercises to get practised.

Date: 12.06.18

M. Giobika
Signature
K. S. R. INSTITUTE FOR ENGINEERING AND TECHNOLOGY,
K. S. R. KALVI NAGAR,
TIRUCHENGODE-637 215
NAMAKKAL DI, TAMIL NADU



Name of the Student: ARUN KUMAR S

Branch: B.E - MECH - A

Year / Sem: II / 3-sem

1. Name of the Training :

2. Name of the Trainer :

3. Students rating of Trainers :

S. No.	Date	Subject	Rating (√)			
			Excellent	Very good	Good	Average
1	13.06.2018	CSC	✓			

4. Two positive points about the programme: we have learnt new language

It will help us to improve our programming skills.

5. Suggestions for improvement:

the class can hold more in the lab.

Date:

S. Arun
Signature



Name of the Student: Ajith Kumar R

Branch: B.E - MECH - A

Year / Sem: II / 3-sem

4. Name of the Training :

5. Name of the Trainer :

6. Students rating of Trainers :

S. No.	Date	Subject	Rating (√)			
			Excellent	Very good	Good	Average
1	13.06.2018	CSC	✓			

4. Two positive points about the programme: we have learnt new language.

It will help us to improve our programming skills.

5. Suggestions for improvement:

the class can hold more in the lab.

Date:

R. Arun
Signature
K. S. R. INSTITUTE FOR
ENGINEERING AND TECHNOLOGY,
K. S. R. KALVI NAGAR,
TIRUCHENGODE-637 215
NAMAKKAL Dt, TAMIL NADU.

**K S R INSTITUTE FOR ENGINEERING AND TECHNOLOGY
TIRUCHENGODE - 637 215**

TRAINING PROGRAMME FEEDBACK FORM



Name of the Student: C. Mohanaraj

Branch: Mech - R

Year / Sem: II / III

1. Name of the Training : Soft Skills
 2. Name of the Trainer : Sathyapriya
 3. Students rating of Trainers : 4/5

S. No.	Date	Subject	Rating (√)			
			Excellent	Very good	Good	Average
1	13/6/18	C Programming	✓			

4. Two positive points about the programme:

- i) Good in teaching
 ii) Good communication.

5. Suggestions for improvement:

- i) Applications needed

Date: 13/6/18 - FN

C. Mohanaraj

Signature

**K S R INSTITUTE FOR ENGINEERING AND TECHNOLOGY
TIRUCHENGODE - 637 215**

TRAINING PROGRAMME FEEDBACK FORM



Name of the Student: R. Saravanan

Branch: Mech-B

Year / Sem: II / IV

4. Name of the Training : Soft Skills
 5. Name of the Trainer : Sathyapriya
 6. Students rating of Trainers : 4/5

S. No.	Date	Subject	Rating (√)			
			Excellent	Very good	Good	Average
1	13/6/18	C Programming	✓			

4. Two positive points about the programme:

- i) Good in teaching
 ii) Good communication

5. Suggestions for improvement:

- (i) Applications needed

Date: 13/6/18 - AN

 PRINCIPAL,
 K. S. R. INSTITUTE FOR
 ENGINEERING AND TECHNOLOGY,
 K. S. R. KALVI NAGAR,
 TIRUCHENGODE-637 215,
 NAMAKKAL Dt. TAMIL NADU,

R. Saravanan
 Signature



Name of the Student: J.P. Jessica Collins

Branch: B.Tech/IT

Year / Sem: II / IV

1. Name of the Training: APS Skill

2. Name of the Trainer: Mr. Vijayaraj Sir

3. Students rating of Trainers :

S. No.	Date	Subject	Rating (√)			
			Excellent	Very good	Good	Average
1	13.6.18	maths	✓			

Topic - Time & work, pipes and cisterns, time, speed distance

4. Two positive points about the programme:
 • Was very easy to cope up with
 • PPT was useful.

5. Suggestions for improvement:

Date: 13.6.18

Signature J.P.



Name of the Student: R. Dhanish Adit

Branch: B. tech/IT

Year / Sem: II / IV

4. Name of the Training: APS Skill

5. Name of the Trainer: Mr. Vijayaraj Sir

6. Students rating of Trainers :

S. No.	Date	Subject	Rating (√)			
			Excellent	Very good	Good	Average
1	13.6.18	Maths	✓			

Topic - Time and work, pipes and cisterns, time, speed distance

4. Two positive points about the programme:
 * PPT presentation was very good

5. Suggestions for improvement:

we want more example every each topics

Date: 13.6.18

PRINCIPAL,
K. S. R. INSTITUTE FOR
ENGINEERING AND TECHNOLOGY,
K. S. R. KALVI NAGAR,
TIRUCHENGODE-637 215,
NAMAKKAL Dt, TAMIL NADU.

Signature R. Dhanish

**K S R INSTITUTE FOR ENGINEERING AND TECHNOLOGY
TIRUCHENGODE - 637 215**

TRAINING PROGRAMME FEEDBACK FORM



Name of the Student: THANESHWARAN.Y.G Branch: IT / IInd Year

Year / Sem: 2nd Year / 3rd Sem

1.Name of the Training : Aptitude Skill training

2.Name of the Trainer : Mr. S. Vijayaraj

3.Students rating of Trainers :

S. No.	Date	Subject	Rating (√)			
			Excellent	Very good	Good	Average
1	14.06.18	Aptitude		✓		

4. Two positive points about the programme:

we learn all the 6 topics

5. Suggestions for improvement:

NO

Date: 14.06.2018

Thanesw Y.G
Signature

**K S R INSTITUTE FOR ENGINEERING AND TECHNOLOGY
TIRUCHENGODE - 637 215**

TRAINING PROGRAMME FEEDBACK FORM



Name of the Student: Sreemathi Indira Branch: IT

Year / Sem: 2 / 3rd sem

4.Name of the Training : Aptitude

5.Name of the Trainer : Mr. S. Vijayaraj

6.Students rating of Trainers :

S. No.	Date	Subject	Rating (√)			
			Excellent	Very good	Good	Average
1	14/06/2018	Maths	✓			

4. Two positive points about the programme:

After explaining work out of sums is useful, and concepts

5. Suggestions for improvement:

are easy understood by solving some problems

Date: 14-06-2018

Sreemathi Indira
Signature
K. S. R. INSTITUTE FOR ENGINEERING AND TECHNOLOGY,
K. S. R. KALVI NAGAR,
TIRUCHENGODE-637 215
NAMAKKAL Dt, TAMIL NADU.



Name of the Student: S. BALAJI

Branch: MECH - A

Year / Sem: 2nd - 3rd sem

1. Name of the Training: BASIC PROGRAMMING SKILLS IN C.

2. Name of the Trainer: PRAKASANT

3. Students rating of Trainers :

S. No.	Date	Subject	Rating (√)			
			Excellent	Very good	Good	Average
1	<u>14.06.18</u>		✓			

4. Two positive points about the programme:

* Very usefull & I more learnt about c programming

5. Suggestions for improvement:

We want more class for programming in system.

Date: 14.06.2018.

S. Balaji
Signature



Name of the Student: C.M. DHARSHAN

Branch: MECH - A

Year / Sem: 2nd yr - 3rd sem.

4. Name of the Training: BASIC PROGRAMMING SKILLS IN C.

5. Name of the Trainer: PRAKASAM.

6. Students rating of Trainers :

S. No.	Date	Subject	Rating (√)			
			Excellent	Very good	Good	Average
1	<u>14-06-18</u>		✓			

4. Two positive points about the programme:

Very usefull, I learnt more about c program

5. Suggestions for improvement:

We want more class for programming in laboratory.

Date: 14-06-2018

PRINCIPAL,
K. S. R. INSTITUTE FOR
ENGINEERING AND TECHNOLOGY,
K. S. R. KAVI NAGAR,
TIRUCHENGODE-637 215,
NAMAKKAL DI, TAMIL NADU.

Signature

C.M. Dharshan

**K S R INSTITUTE FOR ENGINEERING AND TECHNOLOGY
TIRUCHENGODE - 637 215**

TRAINING PROGRAMME FEEDBACK FORM



Name of the Student: MUNEESWARAN D

Branch: BE / MECHANICAL

Year / Sem: II / III

1. Name of the Training: Communication Skill

2. Name of the Trainer: Mugurtharaj

3. Students rating of Trainers :

S. No.	Date	Subject	Rating (√)			
			Excellent	Very good	Good	Average
1	18/06/18(FW)	Communication		✓		

4. Two positive points about the programme:

- 1) Gain more knowledge about communication English
- 2) To know how to speak simple English

5. Suggestions for improvement:

Nil.

Date: 18/06/18.

Signature

[Signature]

**K S R INSTITUTE FOR ENGINEERING AND TECHNOLOGY
TIRUCHENGODE - 637 215**

TRAINING PROGRAMME FEEDBACK FORM



Name of the Student: M. Monish Kanna

Branch: B.E / MECH.

Year / Sem: 2nd / 3rd

4. Name of the Training: placement training

5. Name of the Trainer: C. Mugurtharajan.

6. Students rating of Trainers :

S. No.	Date	Subject	Rating (√)			
			Excellent	Very good	Good	Average
1	18.06.18/AN	Communication English	✓			

4. Two positive points about the programme:

- * developed English knowledge
- * Sir tells very interesting points and facts It is useful

5. Suggestions for improvement:

Nil.

Date: 18.06.2018.

K. S. R. INSTITUTE FOR
ENGINEERING AND TECHNOLOGY,
K. S. R. KALVI NAGAR,
TIRUCHENGODE-637 215,
NAMAKKAL DI, TAMIL NADU.

Signature

**K S R INSTITUTE FOR ENGINEERING AND TECHNOLOGY
TIRUCHENGODE - 637 215**

TRAINING PROGRAMME FEEDBACK FORM



Name of the Student: N. MOHANAPREYA

Branch: B.E - CSE

Year / Sem: ii / iii

1. Name of the Training : C Programming

2. Name of the Trainer : N. Sharmila

3. Students rating of Trainers :

S. No.	Date	Subject	Rating (√)			
			Excellent	Very good	Good	Average
1	12.6.18	C Programming	✓			

4. Two positive points about the programme: Can able to learn the C Programming in detail.

Can able to review and getting thorough in the language

5. Suggestions for improvement:

Extend the classes for one more day.

Date: 12.6.18

N. Mohanapreya
Signature

**K S R INSTITUTE FOR ENGINEERING AND TECHNOLOGY
TIRUCHENGODE - 637 215**

TRAINING PROGRAMME FEEDBACK FORM



Name of the Student: ARUNKUMAR N

Branch: B.E. CSE

Year / Sem: ii / 03

4. Name of the Training : C programming

5. Name of the Trainer : N. Sharmila

6. Students rating of Trainers :

S. No.	Date	Subject	Rating (√)			
			Excellent	Very good	Good	Average
1	12.6.18	C programming			✓	

4. Two positive points about the programme:

To get clear idea about the logic of the program

5. Suggestions for improvement:

Want next level programming

Teaching base

Want next level in programs.

Date: 12.6.18

K. S. R. INSTITUTE FOR
ENGINEERING AND TECHNOLOGY,
TIRUCHENGODE-637 215

PRINCIPAL,

K. P. KRISHNAVI NAGAR,
NANDIKURAL DEPTAMLE NADU.

Signature



Name of the Student: R. Senthil Kumar

Branch: B-TECH-IT

Year / Sem: I yr / III Sem

1. Name of the Training: Programming in c

2. Name of the Trainer: Nandagopal

3. Students rating of Trainers :

functions
structure

S. No.	Date	Subject	Rating (√)			
			Excellent	Very good	Good	Average
1	12.06.18	Programming in c		✓		

4. Two positive points about the programme: * we have done most of the programmes
* level of teaching by staff was good

5. Suggestions for improvement: * apart from basics, many new and advanced concepts can be taught with practice.

Date: 12.06.18

R. Senthil Kumar
Signature



Name of the Student: M. GOBIKA

Branch: IT

Year / Sem: II / III

4. Name of the Training: Programming in c

5. Name of the Trainer: Nandagopal

6. Students rating of Trainers :

S. No.	Date	Subject	Rating (√)			
			Excellent	Very good	Good	Average
1	12.06.18	PROGRAMMING IN C		✓		

4. Two positive points about the programme: In this class, we got the basic ideas about the programming language. Recalling of the basics made us to get clear ideas which is the beginning to our programming skill.

5. Suggestions for improvement:

Exercises to get practised.

Date: 12.06.18

M. Gobika
Signature
K. S. R. KALVI NAGAR,
TIRUCHENGODE-637 215,
NAMAKKAL Dt, TAMIL NADU.

**K S R INSTITUTE FOR ENGINEERING AND TECHNOLOGY
TIRUCHENGODE - 637 215**

TRAINING PROGRAMME FEEDBACK FORM



Name of the Student: ARUN KUMAR S

Branch: B.E - Mech - "A"

Year / Sem: II / 3-sem

1. Name of the Training :

2. Name of the Trainer :

3. Students rating of Trainers :

S. No.	Date	Subject	Rating (√)			
			Excellent	Very good	Good	Average
1	13.06.2018	CSC	✓			

4. Two positive points about the programme: we have learnt new language
It will help us to improve our programming skills.

5. Suggestions for improvement:

like class can held more in the lab.

Date:

S. Arun
Signature

**K S R INSTITUTE FOR ENGINEERING AND TECHNOLOGY
TIRUCHENGODE - 637 215**

TRAINING PROGRAMME FEEDBACK FORM



Name of the Student: Ajith Kumar R

Branch: B.E - Mech - "A"

Year / Sem: II / 3-sem

4. Name of the Training :

5. Name of the Trainer :

6. Students rating of Trainers :

S. No.	Date	Subject	Rating (√)			
			Excellent	Very good	Good	Average
1	13.06.2018	CSC	✓			

4. Two positive points about the programme: we have learnt new language.
It will help us to improve our programming skills.

5. Suggestions for improvement:

the class can held more in the lab.

Date:

K. S. R. INSTITUTE FOR
ENGINEERING AND TECHNOLOGY
K. S. R. KALVI NAGAR,
TIRUCHENGODE-637 215,
NAMAKKAL Dt, TAMIL NADU.

A. Arun
Signature

**K S R INSTITUTE FOR ENGINEERING AND TECHNOLOGY
TIRUCHENGODE - 637 215**

TRAINING PROGRAMME FEEDBACK FORM



Name of the Student: C. Mohanaraj

Branch: Mech - R

Year / Sem: II / II

1. Name of the Training: Soft Skills

2. Name of the Trainer: Sathyavriya

3. Students rating of Trainers: 4/5

S. No.	Date	Subject	Rating (√)			
			Excellent	Very good	Good	Average
1	13/6/18	C Programming	✓			

4. Two positive points about the programme:

- i) Good in teaching
- ii) Good communication.

5. Suggestions for improvement:

- i) Applications needed

Date: 13/6/18 - FN

C. Mohanaraj

Signature

**K S R INSTITUTE FOR ENGINEERING AND TECHNOLOGY
TIRUCHENGODE - 637 215**

TRAINING PROGRAMME FEEDBACK FORM



Name of the Student: R. Saravanan

Branch: Mech - B

Year / Sem: II / IV

4. Name of the Training: Soft Skills

5. Name of the Trainer: Sathyavriya

6. Students rating of Trainers: 4/5

S. No.	Date	Subject	Rating (√)			
			Excellent	Very good	Good	Average
1	13/6/18	C Programming	✓			

4. Two positive points about the programme:

- i) Good in teaching
- ii) Good communication

5. Suggestions for improvement:

- (i) Applications needed.

Date: 13/6/18 - AN

PRINCIPAL,
 K. S. R. INSTITUTE FOR
 ENGINEERING AND TECHNOLOGY,
 K. S. R. KALVI NAGAR,
 TIRUCHENGODE-637 215,
 NAMAKKAL DI, TAMIL NADU.

R. Saravanan

Signature



Name of the Student: J.P. Jessica Collins

Branch: B.Tech/IT

Year / Sem: II / III

1. Name of the Training: APS Skill

2. Name of the Trainer: Mr. Vijayaraj Sir

3. Students rating of Trainers:

S. No.	Date	Subject	Rating (√)			
			Excellent	Very good	Good	Average
1	13.6.18	maths	✓			

Topic - Time & work, pipes and cisterns, time, speed distance

4. Two positive points about the programme:

- Was very easy to cope up with
- PPT was useful.

5. Suggestions for improvement:

Date: 13.6.18

Signature J.P.



Name of the Student: R. Dhanih Adit

Branch: B.Tech/IT

Year / Sem: II / III

4. Name of the Training: APS Skill

5. Name of the Trainer: Mr. Vijayaraj Sir

6. Students rating of Trainers:

S. No.	Date	Subject	Rating (√)			
			Excellent	Very good	Good	Average
1	13.6.18	Maths	✓			

Topic - Time and work, pipes and cisterns, time, speed distance

4. Two positive points about the programme:

• PPT presentation was very good

5. Suggestions for improvement:

we want more example every in

Date: 13.6.18 every each topics

PRINCIPAL
K. S. R. INSTITUTE FOR
ENGINEERING AND TECHNOLOGY,
K. S. R. KALVI NAGAR, R. Dhanih
TIRUCHENGODE - 637 215
NAMAKKAL Dt, TAMIL NADU
Signature

K S R INSTITUTE FOR ENGINEERING AND TECHNOLOGY
TIRUCHENGODE - 637 215

TRAINING PROGRAMME FEEDBACK FORM



Name of the Student: THANESHWARAN Y.G Branch: IT / IInd Year

Year / Sem: 2nd Year / 3rd Sem

1. Name of the Training: Aptitude Skill training

2. Name of the Trainer: Mr. S. Vijayaraj

3. Students rating of Trainers :

S. No.	Date	Subject	Rating (✓)			
			Excellent	Very good	Good	Average
1	14.06.18	Aptitude		✓		

4. Two positive points about the programme:

we learn all the 6 topics

5. Suggestions for improvement:

NO

Thanesw Y.G
Signature

Date: 14.06.2018

K S R INSTITUTE FOR ENGINEERING AND TECHNOLOGY
TIRUCHENGODE - 637 215

TRAINING PROGRAMME FEEDBACK FORM



Name of the Student: Sreemathi Indira Branch: IT

Year / Sem: 2 / 3rd sem

4. Name of the Training: Aptitude

5. Name of the Trainer: Mr. S. Vijayaraj

6. Students rating of Trainers :

S. No.	Date	Subject	Rating (✓)			
			Excellent	Very good	Good	Average
1	14/06/2018	Aptitude	✓			

4. Two positive points about the programme:

After explaining work out of sums is useful, and concepts are

5. Suggestions for improvement:

are easy understood by solving some problems

S Sreemathi Indira
Signature

Date: 14-06-2018

K S R INSTITUTE FOR ENGINEERING AND TECHNOLOGY
TIRUCHENGODE - 637 215

TRAINING PROGRAMME FEEDBACK FORM



Name of the Student: S. BALAJIA

Branch: MECH-A.

Year / Sem: 2nd - 3rd sem

1. Name of the Training: BASIC PROGRAMMING SKILLS IN C.

2. Name of the Trainer: PRAKASAM

3. Students rating of Trainers :

S. No.	Date	Subject	Rating (√)			
			Excellent	Very good	Good	Average
1	<u>14.06.18</u>		✓			

4. Two positive points about the programme:

* Very usefull & I more learnt about c programming

5. Suggestions for improvement:

We want more class for programming in system.

Date: 14.06.2018.

S. Balaji
Signature

K S R INSTITUTE FOR ENGINEERING AND TECHNOLOGY
TIRUCHENGODE - 637 215

TRAINING PROGRAMME FEEDBACK FORM



Name of the Student: C.M. DHARSHAN

Branch: MECH - A

Year / Sem: 2nd yr - 3rd sem.

4. Name of the Training: BASIC PROGRAMMING SKILLS IN C.

5. Name of the Trainer: PRAKASAM.

6. Students rating of Trainers :

S. No.	Date	Subject	Rating (√)			
			Excellent	Very good	Good	Average
1	<u>14-06-18</u>		✓			

4. Two positive points about the programme:

Very usefull , I learnt more about c program

5. Suggestions for improvement:

We want more class for programming in laborator

Date: 14-06-2018

Signature

C.M. Dharshan

**K S R INSTITUTE FOR ENGINEERING AND TECHNOLOGY
TIRUCHENGODE - 637 215**

TRAINING PROGRAMME FEEDBACK FORM



Name of the Student: MUNEESWARAN D

Branch: BE / MECHANICAL

Year / Sem: II / III

1. Name of the Training : Communication Skill

2. Name of the Trainer : Mugurtharaj

3. Students rating of Trainers :

S. No.	Date	Subject	Rating (√)			
			Excellent	Very good	Good	Average
1	18/06/18(FN)	Communication		✓		

4. Two positive points about the programme:

- 1) Gain more knowledge about communication English
- 2) To know how to speak simple English

5. Suggestions for improvement:

NIL.

Date: 18/06/18

Signature

**K S R INSTITUTE FOR ENGINEERING AND TECHNOLOGY
TIRUCHENGODE - 637 215**

TRAINING PROGRAMME FEEDBACK FORM



Name of the Student: M. Monish Kanna

Branch: B.E / MECH.

Year / Sem: 2nd / 3rd

4. Name of the Training : placement training

5. Name of the Trainer : C. Mugurtharajan.

6. Students rating of Trainers :

S. No.	Date	Subject	Rating (√)			
			Excellent	Very good	Good	Average
1	18.06.18/AN	Communications English	✓			

4. Two positive points about the programme:

- * developed English knowledge.
- * Sir tells very interesting points and facts It is usefu

5. Suggestions for improvement:

NIL.

Date: 18.06.2018

PRINCIPAL
K. S. R. INSTITUTE FOR
ENGINEERING AND TECHNOLOGY,
K. S. R. KALVI NAGAR,
TIRUCHENGODE-637 215,
NAMAKKAL DI, TAMIL NADU

Signature

**K S R INSTITUTE FOR ENGINEERING AND TECHNOLOGY
TIRUCHENGODE – 637 215**

TRAINING PROGRAMME FEEDBACK FORM



Name of the Student: J. Ruban Prasad Branch: ECE

Year / Sem: II yr / 2

1. Name of the Training: C programming

2. Name of the Trainer: LAVANYA

3. Students rating of Trainers :

S. No.	Date	Subject	Rating (√)			
			Excellent	Very good	Good	Average
1	18/6/18	C programming		✓		

4. Two positive points about the programme: * Very Usefull
* Good teaching

5. Suggestions for improvement: Nil

Date: 18/6/18

Signature

**K S R INSTITUTE FOR ENGINEERING AND TECHNOLOGY
TIRUCHENGODE – 637 215**

TRAINING PROGRAMME FEEDBACK FORM



Name of the Student: S. Ramya Branch: ECE

Year / Sem: II / 02

4. Name of the Training: c programming

5. Name of the Trainer: Lavanya

6. Students rating of Trainers :

S. No.	Date	Subject	Rating (√)			
			Excellent	Very good	Good	Average
1	18.6.18	c programming			✓	

4. Two positive points about the programme: 1) Good conveying to students
2) Very useful

5. Suggestions for improvement: Nil

Date: 18.6.18

**K. S. R. INSTITUTE FOR
ENGINEERING AND TECHNOLOGY,
K. S. R. KALVI NAGAR,
TIRUCHENGODE-637 215,
NAMAKKAL DISTRICT, TAMIL NADU.**

Signature



Name of the Student: Gowtham M. Branch: ECE - A

Year / Sem: II / III

1. Name of the Training: Programming in C.

2. Name of the Trainer: Bala Krishnan.

3. Students rating of Trainers: 8/10.

S. No.	Date	Subject	Rating (√)			
			Excellent	Very good	Good	Average
1	19.6.18	Programming in C.		✓		

4. Two positive points about the programme:

- * He is so friendly
- * His teaching is understood by me.

5. Suggestions for improvement:

- * To Repeat some difficulties.

Date:

[Signature]
Signature



Name of the Student: S Hemalatha Branch: ECE - A

Year / Sem: II / III

4. Name of the Training: Programming in C

5. Name of the Trainer: Balakrishnan

6. Students rating of Trainers: 8.5/10

S. No.	Date	Subject	Rating (√)			
			Excellent	Very good	Good	Average
1	19.6.18	Programming in C		✓		

4. Two positive points about the programme:

- * His teaching was understood by all.
- * His coaching in lab was excellent.

5. Suggestions for improvement:

- * Explanation of program has to be improved.

Date:

[Signature]
Signature
PRINCIPAL,
K. S. R. INSTITUTE FOR
ENGINEERING AND TECHNOLOGY,
K. S. R. KALVI NAGAR,
TIRUCHENGODE-637 215,
NAMAKKAL DI, TAMIL NADU.

TRAINING PROGRAMME FEEDBACK FORM



Name of the Student: T. Janani Branch: IT

Year / Sem: III/05

1. Name of the Training : Industrial Readiness program

2. Name of the Trainer : Dr. Nandhakumar

3. Students rating of Trainers :

S. No.	Date	Subject	Rating (✓)			
			Excellent	Very good	Good	Average
1	19.06.18	Training program	✓			

4. Two positive points about the programme: 1) Very motivational
2) Interactive section

5. Suggestions for improvement: NIL

Date: 20/6/18

[Signature]
Signature

TRAINING PROGRAMME FEEDBACK FORM



Name of the Student: J. Kausalya Branch: IT

Year / Sem: III/05

4. Name of the Training : Industrial Readiness Program

5. Name of the Trainer : Dr. Nandhakumar

6. Students rating of Trainers :

S. No.	Date	Subject	Rating (✓)			
			Excellent	Very good	Good	Average
1	19.6.18	Training program	✓			

4. Two positive points about the programme: 1) We learn lot about our carrier.
2) Motivational talk.

5. Suggestions for improvement: NIL

Date: 20/6/18

[Signature]
PRINCIPAL,
K S R INSTITUTE FOR
ENGINEERING AND TECHNOLOGY,
K. S. R. KALVI NAGAR,
TIRUCHENGODE-637 215,
NAMAKKAL DI, TAMIL NADU, Signature



Name of the Student: S.S. NAVEEN Branch: ECE

Year / Sem: II yr / 3

1. Name of the Training: C programming

2. Name of the Trainer: LAVANYA

3. Students rating of Trainers: 9/10

S. No.	Date	Subject	Rating (✓)			
			Excellent	Very good	Good	Average
1	19/6/18	C programming		✓		

4. Two positive points about the programme: (i) Method of teaching is Nice
(ii) Problem Solving Methodology is easy

5. Suggestions for improvement:

Nil

Date: 19/6/18

S.S. NAVEEN
Signature



Name of the Student: Priya R Branch: FCE

Year / Sem: II yr / 3

4. Name of the Training: C Programming

5. Name of the Trainer: LAVANYA

6. Students rating of Trainers: 9/10

S. No.	Date	Subject	Rating (✓)			
			Excellent	Very good	Good	Average
1	19/6/18	C Programming		✓		

4. Two positive points about the programme: (i) Explanation of Program is nice
(ii) Programs were made

5. Suggestions for improvement:

Nil

Date: 19/6/18

logging made simple.
K. S. R. INSTITUTE FOR ENGINEERING AND TECHNOLOGY,
K. S. R. KALVI NAGAR,
TIRUCHENGODE-637 215,
NAMAKKAL DISTRICT, TAMIL NADU.
[Signature]
Signature



Name of the Student: P. Sakthivel

Branch: BE - EFF

Year / Sem: II / III

4. Name of the Training: Vijaya Raj

5. Name of the Trainer :

6. Students rating of Trainers :

S. No.	Date	Subject	Rating (√)			
			Excellent	Very good	Good	Average
1	25.6.2018	maths Aptitude		✓		

4. Two positive points about the programme: Good and interest

5. Suggestions for improvement: Need more Explanation

Date: 25.6.2018

P. Sakthivel
Signature



Name of the Student: P. Ramya

Branch: B. E, FEE

Year / Sem: 2018/3rd.

1. Name of the Training: aptitude Test

2. Name of the Trainer: Vijaya Raj

3. Students rating of Trainers :

S. No.	Date	Subject	Rating (√)			
			Excellent	Very good	Good	Average
1	25/6/18	aptitude.	✓			

4. Two positive points about the programme: Very helpful for placement Training

5. Suggestions for improvement:

**K S R INSTITUTE FOR ENGINEERING AND TECHNOLOGY
TIRUCHENGODE – 637 215**



TRAINING PROGRAMME FEEDBACK FORM

Name of the Student: S. Hemalatha

Branch: ECE - A

Year / Sem: II / III

1. Name of the Training : Programming in C

2. Name of the Trainer : Balakerishnan

3. Students rating of Trainers : 8 / 10

S. No.	Date	Subject	Rating (√)			
			Excellent	Very good	Good	Average
1	19/6/18			✓		

4. Two positive points about the programme:

* His teaching was very good

* Understanding level of students was nice

5. Suggestions for improvement:

Teaching programming in C has to be improved.

Date: 19/6/18

S. Hemalatha
Signature

**K S R INSTITUTE FOR ENGINEERING AND TECHNOLOGY
TIRUCHENGODE – 637 215**



TRAINING PROGRAMME FEEDBACK FORM

Name of the Student: G. Geetha Rani

Branch: ECE - A

Year / Sem: II / III

4. Name of the Training : Programming in C

5. Name of the Trainer : Balakerishnan

6. Students rating of Trainers : 8.5 / 10

S. No.	Date	Subject	Rating (√)			
			Excellent	Very good	Good	Average
1	19/6/18				✓	

4. Two positive points about the programme:

* His teaching was good

* Way of approaching was nice

5. Suggestions for improvement:

Explanation of

Date: 19/6/18

PRINCIPAL
 K. S. R. INSTITUTE FOR
 ENGINEERING AND TECHNOLOGY,
 TIRUCHENGODE - 637 215
 NAMAKKAL Dt. TAMIL NADU.

G. Geetha Rani
Signature

**K S R INSTITUTE FOR ENGINEERING AND TECHNOLOGY
TIRUCHENGODE - 637 215**

TRAINING PROGRAMME FEEDBACK FORM



Name of the Student: M. Kavi raj

Branch: MECH

Year / Sem: II / 03

1. Name of the Training : Maths

2. Name of the Trainer : vijayraj

3. Students rating of Trainers :

S. No.	Date	Subject	Rating (√)			
			Excellent	Very good	Good	Average
1	19.06.18	Maths	✓			

4. Two positive points about the programme:

content delivery very nice
easily understand.

5. Suggestions for improvement:

NO Suggestion.

Date: 19.06.18

M. Kavi Raj
Signature

**K S R INSTITUTE FOR ENGINEERING AND TECHNOLOGY
TIRUCHENGODE - 637 215**

TRAINING PROGRAMME FEEDBACK FORM



Name of the Student: Kirubakaran K.

Branch: MECH

Year / Sem: II / 03

4. Name of the Training : Maths

5. Name of the Trainer : vijayraj

6. Students rating of Trainers :

S. No.	Date	Subject	Rating (√)			
			Excellent	Very good	Good	Average
1	19.06.18	Maths		✓		

4. Two positive points about the programme:

class
Smart, very useful
easily understand.

5. Suggestions for improvement:

No suggestions

PRINCIPAL,
K. S. R. INSTITUTE FOR
ENGINEERING AND TECHNOLOGY,
K. S. R. KALVI NAGAR,
TIRUCHENGODE-637 215,
NAMAKKAL Dt. TAMIL NADU.

Date: 19.06.2018

Kirubakaran K.
Signature



Name of the Student: VINOTHICUMAR . T

Branch: MECH 'B'

Year / Sem: I / III

1. Name of the Training: placement Training

2. Name of the Trainer: Mahentharaajan

3. Students rating of Trainers :

S. No.	Date	Subject	Rating (√)			
			Excellent	Very good	Good	Average
1	20/06/18 FN	Communication English	✓			

4. Two positive points about the programme:

* I develop the speaking knowledge.

* AND speak well.

5. Suggestions for improvement:

* weekly once need this type of program.

Date: 20/06/18.

J. Jeyaraj
Signature



Name of the Student: NAPESH.

Branch: MECHANICAL

Year / Sem: II / III

4. Name of the Training: communication

5. Name of the Trainer: Muthaerajan . C

6. Students rating of Trainers :

S. No.	Date	Subject	Rating (√)			
			Excellent	Very good	Good	Average
1	20.6.2018 AN	communication english	✓			

4. Two positive points about the programme:

* Too good to improve my knowledge.

* Best experience with teaching skills.

5. Suggestions for improvement:

should be made by perceived trainer

Date: 20.06.2018

Principal
K. S. R. INSTITUTE FOR
ENGINEERING AND TECHNOLOGY
K. S. R. KALVI NAGAR, Signature
TIRUCHENGODE-637 215,
NAMAKKAL Dt, TAMIL NADU.

**K S R INSTITUTE FOR ENGINEERING AND TECHNOLOGY
TIRUCHENGODE - 637 215**

TRAINING PROGRAMME FEEDBACK FORM



Name of the Student: G. Kamalahasan Branch: EEE

Year / Sem: II / III

1. Name of the Training : BASIC COMMUNICATION SKILL

2. Name of the Trainer : C. ~~MUHUNTHARAJAN~~ MUHUNTHARAJAN

3. Students rating of Trainers :

S. No.	Date	Subject	Rating (√)			
			Excellent	Very good	Good	Average
1	21-6-18	ENGLISH	✓			

4. Two positive points about the programme: i) Basic communication is learned.
ii) We have form a team.

5. Suggestions for improvement:

Nothing

G. Kamalahasan
Signature

Date: 21-6-18

**K S R INSTITUTE FOR ENGINEERING AND TECHNOLOGY
TIRUCHENGODE - 637 215**

TRAINING PROGRAMME FEEDBACK FORM



Name of the Student: R. ASHA Branch: B. E EEE

Year / Sem: II / III

4. Name of the Training : Basic Communication Skills

5. Name of the Trainer : Dr. C. Muhuntharajan

6. Students rating of Trainers :

S. No.	Date	Subject	Rating (√)			
			Excellent	Very good	Good	Average
1	21-6-18	Listening Skills, speaking.	✓			

4. Two positive points about the programme: i) Make Everyone to share their ideas in simple English.
ii) Encouraged students to speak English.

5. Suggestions for improvement:

More Interactions.

R. Asha
Signature

Date: 21-6-18

PRINCIPAL,
K. S. R. INSTITUTE FOR
ENGINEERING AND TECHNOLOGY,
K. S. R. KATY. NAGAR,
TIRUCHENGODE-637 215,
NAMAKKAL DL, TAMIL NADU.



Name of the Student: N. MOHANAPREYF

Branch: B.E - CSE

Year / Sem: II (II)

1. Name of the Training : APTITUDE TRAINING

2. Name of the Trainer : M.S. VISAYARAJ

3. Students rating of Trainers :

S. No.	Date	Subject	Rating (✓)			
			Excellent	Very good	Good	Average
1	21.6.18	aptitude training	✓			

4. Two positive points about the programme:

able to learn many different topics

5. Suggestions for improvement: getting thorough in the topics helps to gain knowledge.

Extend the class for one more day

Date: 21.6.18

N. Mohanofj.
Signature



Name of the Student: J. Deepak Kumar

Branch: CSE

Year / Sem: II (II)

4. Name of the Training : APTITUDE TRAINING

5. Name of the Trainer : Ms. Vijayaraj

6. Students rating of Trainers : Good

S. No.	Date	Subject	Rating (✓)			
			Excellent	Very good	Good	Average
1	21.6.18	Maths			✓	

4. Two positive points about the programme:

Thinking and calculating ✓

5. Suggestions for improvement:

Clear and neat speech.

Date: 21.6.18

PRINCIPAL
K. S. R. INSTITUTE FOR
ENGINEERING AND TECHNOLOGY
K. S. R. KALVI NAGAR,
TIRUCHENGODE-637 215,
NAMAKKAL DI, TAMIL NADU.

J. Deepak
Signature

TIRUCHENGODE - 637 215
TRAINING PROGRAMME FEEDBACK FORM



Name of the Student: A. RAMYA Branch: RE-EEE

Year / Sem: 2nd - 3rd

1. Name of the Training: communication skill

2. Name of the Trainer :

3. Students rating of Trainers :

S. No.	Date	Subject	Rating (√)			
			Excellent	Very good	Good	Average
1	22-06-2018	English	✓			

4. Two positive points about the programme:

* It is very interesting and learn more
*

5. Suggestions for improvement:

I try to talk to speak in english here After
Signature A. Ramya

Date: 22-06-2018

K S R INSTITUTE FOR ENGINEERING AND TECHNOLOGY
TIRUCHENGODE - 637 215
TRAINING PROGRAMME FEEDBACK FORM



Name of the Student: A. Karim muthu Kumar Branch: RE-EEE

Year / Sem: II / III

4. Name of the Training: Basic communication skills

5. Name of the Trainer: Mr. Mukhtharjan

6. Students rating of Trainers :

S. No.	Date	Subject	Rating (√)			
			Excellent	Very good	Good	Average
1	22.06.18	English	✓			

4. Two positive points about the programme:

* It is very useful.
* It is very interesting.

5. Suggestions for improvement:

The duration of the program ✓

Date: is less. It should be increased

22.06.18

Signature

PRINCIPAL
K. S. R. INSTITUTE FOR
ENGINEERING AND TECHNOLOGY,
K. S. R. KALVI NAGAR,
TIRUCHENGODE-637 215,
NAMAKKAL Dt, TAMIL NADU.



Name of the Student: M. Gobika

Branch: IT/B.Tech

Year / Sem: V / 03

1. Name of the Training: COMMUNICATIVE SKILLS

2. Name of the Trainer: MUGUNTHARAJAN - C

3. Students rating of Trainers :

S. No.	Date	Subject	Rating (✓)			
			Excellent	Very good	Good	Average
1	25.06.18	ENGLISH		✓		

4. Two positive points about the programme: The training was entirely useful to make us strong in the communication side. New innovative thoughts and ideas was gained.

5. Suggestions for improvement: these are no more suggestions.

Date: 25.06.18

[Signature]
Signature



Name of the Student: G. Mounish

Branch: B.Tech/IT

Year / Sem: I / 03

4. Name of the Training: COMMUNICATIVE SKILLS

5. Name of the Trainer: MUGUNTHARAJAN - C

6. Students rating of Trainers :

S. No.	Date	Subject	Rating (✓)			
			Excellent	Very good	Good	Average
1	25.06.18	English	✓			

4. Two positive points about the programme: The training was very effective to learn so many things

5. Suggestions for improvement: Maintain the same improvement on tomorrow.

Date: 25-06-18.

[Signature]
Signature

PRINCIPAL
K. S. R. INSTITUTE FOR
ENGINEERING AND TECHNOLOGY,
K. S. R. KALVI NAGAR,
TIRUCHENGODE-637 215,
NAMAKKAL Dt, TAMIL NADU.



Name of the Student: Lakshmanan

Branch: B.Tech ET

Year / Sem: II / III

1. Name of the Training: Dr. M. Muguntharaj Communication skill

2. Name of the Trainer: Dr. C. Muguntharaj

3. Students rating of Trainers :

S. No.	Date	Subject	Rating (✓)			
			Excellent	Very good	Good	Average
1	26.06.18	Communication skill	✓			

4. Two positive points about the programme: Sir taught to us, how to improve our communication skills in multi way. Sir gave us lot and lot of activity to improve communication, these sir gave to us are very good...

5. Suggestions for improvement: No suggestions.

Date: Sir taught us in good way. D. Lalo Signature



Name of the Student: Gobika M.

Branch: B.Tech /IT

Year / Sem: II / III

4. Name of the Training: communicative skill

5. Name of the Trainer: Dr. C. Muguntharaj

6. Students rating of Trainers :

S. No.	Date	Subject	Rating (✓)			
			Excellent	Very good	Good	Average
1	26.06.18	communicative skill	✓			

4. Two positive points about the programme: The training brought us many innovative thinkings to improve the communicative skills. Many activities that gave us enough stuff to improve ourself.

5. Suggestions for improvement: I hope the training was more over good.

Date: 26.06.18 M. Gobika Signature

PRINCIPAL,
K. S. R. INSTITUTE FOR
ENGINEERING AND TECHNOLOGY,
K. S. R. KALVI NAGAR,
TIRUCHENGODE-637 215,
NAMAKKAL Dt. TAMIL NADU.



Name of the Student: S. HEMALATHA

Branch: B.E - EEE

Year / Sem: II / III

1. Name of the Training: Basic Aptitude Skill

2. Name of the Trainer: Vijayaraj

3. Students rating of Trainers :

S. No.	Date	Subject	Rating (✓)			
			Excellent	Very good	Good	Average
1	26-06-18	Basic Aptitude Skill		✓		

4. Two positive points about the programme: We are allowed to solve the problems

5. Suggestions for improvement: Give more problems to improve our skills

Date: 26-06-18

[Signature]
Signature



Name of the Student: S. Kavin Muthu Kumar

Branch: B.E

Year / Sem: II / III

4. Name of the Training: Basic Aptitude Skills.

5. Name of the Trainer: Vijayaraj

6. Students rating of Trainers :

S. No.	Date	Subject	Rating (✓)			
			Excellent	Very good	Good	Average
1	26-06-18	Basic Aptitude Skill	✓			

4. Two positive points about the programme: It is interesting.

It is easy to understand.

5. Suggestions for improvement:

Time is insufficient.

Date: 26-06-18

[Signature]

Signature

PRINCIPAL,
K. S. R. INSTITUTE FOR
ENGINEERING AND TECHNOLOGY,
K. S. R. KALVI NAGAR,
TIRUCHENGODE-637 215,
NAMAKKAL DI, TAMIL NADU.

**K S R INSTITUTE FOR ENGINEERING AND TECHNOLOGY
TIRUCHENGODE - 637 215**

TRAINING PROGRAMME FEEDBACK FORM



Name of the Student: Kishor - M

Branch: ECE

Year / Sem: II / III
A

1. Name of the Training : Communication Skills

2. Name of the Trainer : C. Muthurajan

3. Students rating of Trainers : 9/10

S. No.	Date	Subject	Rating (√)			
			Excellent	Very good	Good	Average
1	28.6.18	Communication Skills	✓			

4. Two positive points about the programme:

- Essential for Interview
- Understandable

5. Suggestions for improvement:

—

Date: 28.6.18

Kishor - M

Signature

**K S R INSTITUTE FOR ENGINEERING AND TECHNOLOGY
TIRUCHENGODE - 637 215**

TRAINING PROGRAMME FEEDBACK FORM



Name of the Student: Hemalatha S

Branch: ECE

Year / Sem: II / III
A

4. Name of the Training : Communication Skills

5. Name of the Trainer : C. Muthurajan

6. Students rating of Trainers : 9.5/10

S. No.	Date	Subject	Rating (√)			
			Excellent	Very good	Good	Average
1	28.6.18	Communication Skills	✓			

4. Two positive points about the programme: - Useful

5. Suggestions for improvement:

PRINCIPAL,
K. S. R. INSTITUTE FOR
ENGINEERING AND TECHNOLOGY,
K. S. R. KALVI NAGAR,
TIRUCHENGODE-637 215,
NAMAKKAL, DISTRICT, TAMIL NADU.

Date: 28.6.18

Hemalatha S

Signature



Name of the Student: Sukhesan C

Branch: ECE

Year / Sem: II / III

1. Name of the Training: APTITUDE

2. Name of the Trainer: VIJAYARAJ

3. Students rating of Trainers :

S. No.	Date	Subject	Rating (√)			
			Excellent	Very good	Good	Average
1	28.06.18	APTITUDE		✓		

4. Two positive points about the programme: I have improved my Aptitude knowledge.

5. Suggestions for improvement: No.

Date: 28.08.18

[Signature]
Signature



Name of the Student: V. Raghu Ramachandran Branch: ECE

Year / Sem: II - III Sem

4. Name of the Training: APTITUDE

5. Name of the Trainer: Vijayaraj

6. Students rating of Trainers :

S. No.	Date	Subject	Rating (√)			
			Excellent	Very good	Good	Average
1	28.06.18	Aptitude		✓		

4. Two positive points about the programme: It is used to solve the problem easily.

5. Suggestions for improvement: No

Date: 28.08.18

[Signature]
PRINCIPAL,
K. S. R. INSTITUTE FOR
ENGINEERING AND TECHNOLOGY,
K. S. R. KALVI NAGAR,
TIRUCHENGODE-637 215,
NAMAKKAL Dt, TAMIL NADU.

V. Raghu Ramachandran
Signature

TRAINING PROGRAMME FEEDBACK FORM



Name of the Student: R. Priya Branch: ECE

Year / Sem: V / III

1. Name of the Training : Aptitude

2. Name of the Trainer : Vijayaraj

3. Students rating of Trainers : 10/10

S. No.	Date	Subject	Rating (√)			
			Excellent	Very good	Good	Average
1	29/06/18	Aptitude		✓		

4. Two positive points about the programme:

Easy to solve the Problem

5. Suggestions for improvement:

NIL

Date: 29/06/18

R. Priya
Signature

TRAINING PROGRAMME FEEDBACK FORM



Name of the Student: SINDHUJA Branch: ECE

Year / Sem: V / III

4. Name of the Training : Aptitude

5. Name of the Trainer : Vijayaraj

6. Students rating of Trainers :

S. No.	Date	Subject	Rating (√)			
			Excellent	Very good	Good	Average
1	29/06/18	Aptitude		✓		

4. Two positive points about the programme:

We are able to do problems shortly and easily and it improved logical thinking.

5. Suggestions for improvement:

NIL

Date: 29/06/18

PRINCIPAL,
K. S. R. INSTITUTE FOR
ENGINEERING AND TECHNOLOGY,
K. S. R. KALVI NAGAR, Signature
TIRUCHENGODE-637 215,
NAMAKKAL Dt, TAMIL NADU.



Name of the Student: R. Hari Hara Sudhan

Branch: ECCE - A

Year / Sem: 2nd / 3rd

1. Name of the Training: COMMUNICATION SKILLS

2. Name of the Trainer: C. MUHUNTHARAJAN

3. Students rating of Trainers: 10

S. No.	Date	Subject	Rating (✓)			
			Excellent	Very good	Good	Average
1	29/8/2018	COMMUNICATION SKILLS	✓			

4. Two positive points about the programme:

His class can't bore

His class is useful for remove our stage fear

5. Suggestions for improvement:

Date: 29/8/2018

R. Hari Hara Sudhan
Signature



Name of the Student: N. DHANUSHKODI

Branch: ECCE - A

Year / Sem: 2nd / 3rd

4. Name of the Training: C. MUHUNTHARAJAN

5. Name of the Trainer: Communication skills

6. Students rating of Trainers: 10

S. No.	Date	Subject	Rating (✓)			
			Excellent	Very good	Good	Average
1	29/6/18	Communication skills	✓			

4. Two positive points about the programme:

* our class was so Excitement.

* It is useful for placement

5. Suggestions for improvement:

Date: 29/6/18

PRINCIPAL,
K. S. R. INSTITUTE FOR
ENGINEERING AND TECHNOLOGY,
K. S. R. KALVI NAGAR,
TIRUCHENGODE - 637 215,
NAMAKKAL DI, TAMIL NADU.

N. 2
Signature



Name of the Student: T. Arun Kumar

Branch: Mech - A.

Year / Sem: II Year / II sem.

4. Name of the Training: placement training [English].

5. Name of the Trainer: C. Muguntharajan

6. Students rating of Trainers :

S. No.	Date	Subject	Rating (✓)			
			Excellent	Very good	Good	Average
1	3.7.18	English	✓			

4. Two positive points about the programme: *) To learn communicative skills.

*) To learn more general knowledge

5. Suggestions for improvement:

Date: 3.7.18

Signature

T. Arun Kumar



Name of the Student: R. Govindharasu

Branch: Mechanical.

Year / Sem: II year / II sem

1. Name of the Training: placement training (english)

2. Name of the Trainer: muguntharajan

3. Students rating of Trainers :

S. No.	Date	Subject	Rating (✓)			
			Excellent	Very good	Good	Average
1	3.7.18	English	✓			

PRINCIPAL.

4. Two positive points about the programme:

i) Visual aids
ii) Improve the knowledge

5. Suggestions for improvement:

*

Date: 3.7.18

R. Govindharasu
Signature



Name of the Student: NAVEEN. V

Branch: MECHANICAL.

Year / Sem: II Year, II sec.

1. Name of the Training: APTITUDE.

2. Name of the Trainer: Vijayarajan

3. Students rating of Trainers :

S. No.	Date	Subject	Rating (√)			
			Excellent	Very good	Good	Average
1	3/7/18	APTITUDE			✓	

4. Two positive points about the programme:

- * It was very useful.
- * The problem learn learn easily

5. Suggestions for improvement:

- * Give some activity at the centre of class

Date: 3/7/18.

Naveen V
Signature



Name of the Student: PRAGIATHEESWAR.E

Branch: MECHANICAL

Year / Sem: II - Year, III sec

4. Name of the Training: APTITUDE

5. Name of the Trainer: Vijayarajan

6. Students rating of Trainers :

S. No.	Date	Subject	Rating (√)			
			Excellent	Very good	Good	Average
1	3/7/18	APTITUDE	✓			

4. Two positive points about the programme:

- * It is very useful to develop our knowledge
- * It is very interesting to listen

5. Suggestions for improvement:

- * There is no suggestions for my side.

Date:

SEP
PRINCIPAL.
K. S. R. INSTITUTE FOR
ENGINEERING AND TECHNOLOGY,
K. S. R. KALVI NAGAR,
TIRUCHENGODE-637 215,
NAMAKKAL DI, TAMIL NADU.

SEP
Signature



TRAINING PROGRAMME FEEDBACK FORM

Name of the Student: P. SURENDHAR

Branch: Mech-B

Year / Sem: 2nd / 3rd sem

1. Name of the Training: APTITUDE

2. Name of the Trainer: Vijayaraj

3. Students rating of Trainers :

S. No.	Date	Subject	Rating (✓)			
			Excellent	Very good	Good	Average
1	4.7.2018	APTITUDE		✓		

4. Two positive points about the programme: Improve the analysing problems, to improve present of mid.

5. Suggestions for improvement: Nil

Date: 4.7.2018

P. SURENDHAR
Signature



TRAINING PROGRAMME FEEDBACK FORM

Name of the Student: M. NAVEEN

Branch: Mech-B

Year / Sem: 2nd / 3rd sem

4. Name of the Training: APTITUDE

5. Name of the Trainer: Vijayarajan

6. Students rating of Trainers :

S. No.	Date	Subject	Rating (✓)			
			Excellent	Very good	Good	Average
1	4.7.2018	APTITUDE			✓	

4. Two positive points about the programme: Improve the maths sum

5. Suggestions for improvement: Nil

Date: 4.7.16

PRINCIPAL,
K. S. R. INSTITUTE FOR
ENGINEERING AND TECHNOLOGY,
K. S. R. KALVI NAGAR,
TIRUCHENGODE-637 215,
NAMAKKAL Dt. TAMIL NADU.

M. NAVEEN
Signature



Name of the Student: S. TEJASWINI Branch: ECE

Year / Sem: IInd - IIIrd

1. Name of the Training: BASIC COMMUNICATION SKILL

2. Name of the Trainer: MUKUNTHRAJAN

3. Students rating of Trainers: 10

S. No.	Date	Subject	Rating (✓)			
			Excellent	Very good	Good	Average
1	2.08.18	ENGLISH		✓		

4. Two positive points about the programme:

It was very interactive and entertaining.
And it helped us to overcome the obstacles of stage fear.

5. Suggestions for improvement:

Activities for the student should be increased.

Date: 02.08.18

S. Tejaswin
Signature



Name of the Student: K. Thangaraj Kumar Branch: ECE

Year / Sem: II - III

4. Name of the Training: BASIC COMMUNICATION SKILL

5. Name of the Trainer: MUKUNTHRAJAN

6. Students rating of Trainers: 10

S. No.	Date	Subject	Rating (✓)			
			Excellent	Very good	Good	Average
1	2.08.18	English		✓		

4. Two positive points about the programme:

It was very interactive and entertaining and it helped us to overcome the obstacles of stage fear.

5. Suggestions for improvement:

Activities for the student should be increased.

Date:

2/8/18

Signature

PRINCIPAL,
K. S. R. INSTITUTE FOR
ENGINEERING AND TECHNOLOGY,
K. S. R. KALVI NAGAR,
TIRUCHENGODE-637 215,
NAMAKKAL Dt, TAMIL NADU.

K. Thangaraj

Name of the Student: PARKAVI. S Branch: ECEYear / Sem: II / III1. Name of the Training: COMMUNICATION SKILLS2. Name of the Trainer: DR. C. MUGUNDHARAJAN3. Students rating of Trainers: 10

S. No.	Date	Subject	Rating (✓)			
			Excellent	Very good	Good	Average
1	2.8.18	ENGLISH		✓		

4. Two positive points about the programme: 1. We enjoyed a lot during thisProgram. 2. We improved something better than

5. Suggestions for improvement:

We need more activity.before.Date: 3.8.18Signature: [Signature]Name of the Student: Priyanka.V Branch: ECEYear / Sem: II / III4. Name of the Training: Communication Skills5. Name of the Trainer: Dr. C. Mugundharajan6. Students rating of Trainers: 9

S. No.	Date	Subject	Rating (✓)			
			Excellent	Very good	Good	Average
1	2.8.2018	English	✓			

4. Two positive points about the programme: We learn about language and
how to improve our soft skills.

5. Suggestions for improvement: ✓

Date: 2.8.2018Signature: [Signature]

PRINCIPAL,
K. S. R. INSTITUTE FOR
ENGINEERING AND TECHNOLOGY,
K. S. R. KALVI NAGAR,
TIRUCHENGODE-637 215,
NAMAKKAL Dt, TAMIL NADU.

TRAINING AND PLACEMENT CELL



Training Schedule [2018 - 2019] Odd Semester

Ref: KSRIET/T&P/CIR/2018-19

Date: 22.05.2018

This is to inform all the HoD's, Faculties & Department Training and Placement coordinators that the Internal Training for II year, III year & IV year PRP students on various topics for the academic year 2018 - 2019 (Odd Sem) has been scheduled. All the registered students should attend the Training Programme without fail. If any student skips this Training Programme without proper permission from the respective HoDs, he / she will not be permitted for any further Training Programme and campus recruitment process. Proper Dress Code is mandatory.

Encl.,

Detailed Training Schedule - Year Wise

T&P OFFICER

T&P COORDINATOR

PRINCIPAL

Copy to:

1. All HoDs
2. Notice Board

PRINCIPAL
K. S. R. INSTITUTE FOR
ENGINEERING AND TECHNOLOGY,
K. S. R. KALVI NAGAR,
TIRUCHENGODE-637 215,
NAMAKKAL DI, TAMIL NADU.

Branch	Day 1		Day 2		Day 3		Day 4		Day 5		Day 6	
	Date	Topics	Date	Topics	Date	Topics	Date	Topics	Date	Topics	Date	Topics
ECE A	12.06.18	Industry Readiness Programme	20.06.18	Programing Skills in JAVA	21.06.18	Programming Skills in JAVA	22.06.18	Programming Skills in JAVA	23.07.18	Advance Communication Skills	24.07.18	Advance Communication Skills
Faculty Name	Dr.R.Nandakumar HoD / ECE		R Venkatesan AP/CSE		R Venkatesan AP/CSE		R Venkatesan AP/CSE		Dr.C.Muhuntarajan HoD / English		Dr.C.Muhuntarajan HoD / English	
Venue	EEE Seminar Hall		FN:Hall No - 208 FN & AN: VLSI Lab		FN:Hall No - 208 FN & AN: VLSI Lab		FN:Hall No - 208 FN & AN: VLSI Lab		ECE Seminar hall		ECE Seminar hall	
ECE B	14.06.18	Industry Readiness Programme	20.06.18	Programming Skills in JAVA	21.06.18	Programming Skills in JAVA	22.06.18	Programming Skills in JAVA	26.07.18	Advance Communication Skills	27.07.18	Advance Communication Skills
Faculty Name	Dr.R.Nandakumar HoD / ECE		R Gobal AP/CSE		R Gobal AP/CSE		R Gobal AP/CSE		Dr.C.Muhuntarajan HoD / English		Dr.C.Muhuntarajan HoD / English	
Venue	EEE Seminar Hall		FN:Hall No - 211 FN & AN: DSP Lab		FN:Hall No - 211 FN & AN: DSP Lab		FN:Hall No - 211 FN & AN: DSP Lab		ECE Seminar hall		ECE Seminar hall	
MECH A	26.06.18	Industry Readiness Programme	30.07.18	Advance Communication Skills	31.07.18	Advance Communication Skills	 PRINCIPAL, K. S. R. INSTITUTE FOR ENGINEERING AND TECHNOLOGY, K. S. R. KALVI NAGAR, TIRUCHENGODE 637 215, NAMAKKAL DI, TAMIL NADU.					
Faculty Name	Dr.R.Nandakumar HoD / ECE		Dr.C.Muhuntarajan HoD / English		Dr.C.Muhuntarajan HoD / English							
Venue	EEE Seminar Hall		EEE Seminar Hall		EEE Seminar Hall							
MECH B	28.06.18	Industry Readiness Programme	06.08.18	Advance Communication Skills	07.08.18	Advance Communication Skills	 T & P COORDINATOR					
Faculty Name	Dr.R.Nandakumar HoD / ECE		Dr.C.Muhuntarajan HoD / English		Dr.C.Muhuntarajan HoD / English							
Venue	EEE Seminar Hall		EEE Seminar Hall		EEE Seminar Hall							

T.P. COF
8/9/18

T & P COORDINATOR

PRINCIPAL

K S R INSTITUTE FOR ENGINEERING AND TECHNOLOGY, TIRUCHENGODE - 637215

Training and placement Cell

III Year Training Schedule with Venue Details [Odd Semester]

Batch: 2016- 2020

Academic Year:2018- 2019

Branch	Day 1		Day 2		Day 3		Day 4		Day 5		Day 6	
	Date	Topics	Date	Topics	Date	Topics	Date	Topics	Date	Topics	Date	Topics
CSE	21.06.18	Industry Readiness Programme	25.06.18	Programming Skills in JAVA	26.06.18	Programming Skills in JAVA	27.06.18	Programming Skills in JAVA	05.07.18	Advance Communication Skills	06.07.18	Advance Communication Skills
Faculty Name	Dr.R.Nandakumar HoD / ECE		D Kavinya AP/CSE		D Kavinya AP/CSE		D Kavinya AP/CSE		Dr.C.Muhuntarajan HoD / English		Dr.C.Muhuntarajan HoD / English	
Venue	ECE Seminar Hall		FN:Hall No - 102 FN & AN: CSE Lab - II		FN:Hall No - 102 FN & AN: CSE Lab - II		FN:Hall No - 102 FN & AN: CSE Lab - II		EEE Seminar Hall		EEE Seminar Hall	
IT	19.06.18	Industry Readiness Programme	25.06.18	Programming Skills in JAVA	26.06.18	Programming Skills in JAVA	27.06.18	Programming Skills in JAVA	09.07.18	Advance Communication Skills	10.07.18	Advance Communication Skills
Faculty Name	Dr.R.Nandakumar HoD / ECE		L Deepan Prabu AP/IT		L Deepan Prabu AP/IT		L Deepan Prabu AP/IT		Dr.C.Muhuntarajan HoD / English		Dr.C.Muhuntarajan HoD / English	
Venue	ECE Seminar Hall		FN:Hall No - 104 FN & AN: IT Lab - II		FN:Hall No - 104 FN & AN: IT Lab - II		FN:Hall No - 104 FN & AN: IT Lab - II		ECE Seminar hall		ECE Seminar hall	
EEE	20.06.18	Programming Skills in JAVA	21.06.18	Programming Skills in JAVA	22.06.18	Programming Skills in JAVA	30.06.18	Industry Readiness Programme	12.07.18	Advance Communication Skills	13.07.18	Advance Communication Skills
Faculty Name	L Deepan Prabu AP/IT		L Deepan Prabu AP/IT		L Deepan Prabu AP/IT		Dr.R.Nandakumar HoD / ECE		Dr.C.Muhuntarajan HoD / English		Dr.C.Muhuntarajan HoD / English	
Venue	FN:Hall No - 106 FN & AN: CSE Lab - I		FN:Hall No - 106 FN & AN: CSE Lab - I		FN:Hall No - 106 FN & AN: CSE Lab - I		EEE Seminar Hall		ECE Seminar hall		ECE Seminar hall	

PRINCIPAL,
 K. S. R. INSTITUTE FOR
 ENGINEERING AND TECHNOLOGY,
 K. S. R. KALVI NAGAR,
 TIRUCHENGODE-637 215,
 NAMAKKAL Dt, TAMIL NADU.

BATCH : 2016 - 2020

Academic Year: 2018 - 2019

Training Topics		Industry Readiness Training Programme				Advance Communication Skills			
Name of the Trainer		Dr.R.Nandakumar HoD / ECE				Dr.C.Muhuntarajan HoD/Eng			
Date of Training Programme		12.06.18		23.07.18		24.07.18			
S. No	Name	FN	AN	FN	AN	FN	AN		
1	731616106001	ABDULKADHAR S	/	/	/	/	/	/	
2	731616106002	ABISHEK T	a	a	/	/	/	/	
3	731616106003	ADHITHYA KUMAR M	/	/	/	/	/	/	
4	731616106004	AJEETH KUMAR M	a	a	/	/	/	/	
5	731616106005	AKSHAYA N M	/	/	/	/	/	/	
6	731616106006	ANANTH N	/	/	/	/	/	/	
7	731616106007	ANANTHA KRISHNAN P	/	/	/	/	/	/	
8	731616106008	ARULIEESWARAN R	/	/	a	a	/	/	
9	731616106009	ASWIN S	/	/	/	/	/	/	
10	731616106010	BALAJI R	/	/	/	/	/	/	
11	731616106011	BHAVYA D	/	/	/	/	/	/	
12	731616106012	BHAVYASHREE S	/	/	/	/	/	/	
13	731616106013	BHUVANESHWARI P	a	a	/	/	/	/	
14	731616106014	BRAHADEESHWARAN M	a	a	/	/	/	/	
15	731616106015	BRINDHA M	/	/	/	/	/	/	
16	731616106016	DANATHARSHINI G	/	/	/	/	/	/	
17	731616106017	DHARANI V	/	/	/	/	/	/	
18	731616106018	DHIVYA T	/	/	/	/	/	/	
19	731616106019	DINESH KRISHNA S	a	a	/	/	/	/	
20	731616106020	DIVYA T	/	/	/	/	/	/	
21	731616106021	DURAIRAJ S	/	/	/	/	/	/	
22	731616106022	ELANGO VAN V	/	/	/	/	/	/	
23	731616106023	GOKULAKRISHNAN A	/	/	/	/	/	/	
24	731616106024	GOWTHAM M	/	/	/	/	/	/	
25	731616106026	ILAKIYA S	/	/	/	/	/	/	
26	731616106027	INDIRAKUMAR M	a	a	/	/	/	/	
27	731616106028	ISWARYA P	/	/	/	/	/	/	
28	731616106029	JAYASHRI M	/	/	/	/	/	/	
29	731616106030	KAJAPATHY V	/	/	/	/	/	/	
30	731616106031	KANIMOZHI R	/	/	/	/	/	/	
31	731616106032	KARTHIKEYAN S	/	/	/	/	/	/	
32	731616106033	KARTHIKEYAN V	/	/	/	/	/	/	

PRINCIPAL
K. S. R. INSTITUTE FOR
ENGINEERING AND TECHNOLOGY,
K. S. R. KALMI NAGAR,
TIRUCHENGODE-637 215,
NAMAKKAL DI, TAMIL NADU.

Date of Training Programme			12.06.18		23.06.18		24.06.18	
S. No		Name	FN	AN	FN	AN	FN	AN
33	731616106034	KOKILA K	1	1	1	1	1	1
34	731616106035	LAKSHMANAN R	a	a	1	1	1	1
35	731616106036	LOGESH KUMAR K	a	a	1	1	1	1
36	731616106037	MAHESWARAN J	1	1	1	1	1	1
37	731616106038	MALATHI A S	1	1	1	1	1	1
38	731616106039	MARIMUTHU M	1	1	1	1	a	a
39	731616106040	MEENA A	1	1	1	1	1	1
40	731616106041	MEKALAI K	1	1	1	1	1	1
41	731616106042	MONIKA R	1	1	1	1	1	1
PRESENT			33	33	40	40	40	40
ABSENT			8	8	1	1	1	1
PERMISSION			-	-	-	-	-	-
OD			-	-	-	-	-	-
NI			-	-	-	-	-	-

 PRINCIPAL,
 K. S. R. INSTITUTE FOR
 ENGINEERING AND TECHNOLOGY,
 K. S. R. KALVI NAGAR,
 TIRUCHENGODE-637 215,
 NAMAKKAL DI, TAMIL NADU.

Training and Placement Cell

ECE B - Internal Industry Readiness Training Programme, Programming Skills In Java & Advance Communication Skills Training Attendance

BATCH : 2016 - 2020

Academic Year: 2018 - 2019

Training Topics		Industry Readiness Training Programme				Advance Communication Skills			
Name of the Trainer		Dr.R.Nandakumar HoD / ECE				Dr.C.Muhuntarajan HoD/Eng			
Date of Training Programme			14.06.18.		15.08 26.07.18		14.08 27.07.18		
S. No	Reg no	Name	FN	AN	FN	AN	FN	AN	
1	731616106043	MUGILAN M	/	/	a	a	/	/	
2	731616106044	NANDHAKUMAR M	/	/	/	/	/	/	
3	731616106045	NANDHAKUMAR P	/	/	/	/	/	/	
4	731616106046	NANDHAKUMARAN R	/	/	/	/	/	/	
5	731616106047	NARESHKUMAR S	/	/	a	a	/	/	
6	731616106048	NAVEEN K	/	/	/	/	/	/	
7	731616106049	NIVETHA S	/	/	/	/	/	/	
8	731616106050	NIVETHA T	/	/	/	/	a	a	
9	731616106051	POORNIMA N	/	/	/	/	/	/	
10	731616106052	PRAVEENA M	/	/	/	/	/	/	
11	731616106053	PRIYADHARSHINI M	/	/	/	/	/	/	
12	731616106054	PRIYADHARSHINI S	/	/	/	/	/	/	
13	731616106055	PRIYADHARSHNI P	/	/	/	/	/	/	
14	731616106056	PRIYANKA C	a	a	/	/	/	/	
15	731616106057	PRIYANKA S S	/	/	/	/	/	/	
16	731616106058	RAMYA SRI E	/	/	/	/	/	/	
17	731616106059	RANJITH V	/	/	a	a	/	/	
18	731616106060	ROSHINI T	/	/	/	/	/	/	
19	731616106061	SAKTHI PRIYA S	/	/	/	/	/	/	
20	731616106062	SANTHIA G	/	/	/	/	/	/	
21	731616106063	SANTHOSHKUMAR J	/	/	/	/	/	/	
22	731616106064	SATHYAMOORTHY K	/	/	/	/	/	/	
23	731616106065	SELLAKRISHNARAJA S	/	/	/	/	/	/	
24	731616106066	SHARVESH RAM K R	/	/	/	/	/	/	
25	731616106067	SHOWMIYA M	/	/	a	a	/	/	
26	731616106068	SHYAM SUNDAR R	/	/	/	/	/	/	
27	731616106069	SRIMATHI G	/	/	/	/	/	/	
28	731616106070	SUBASH V	a	a	/	/	/	/	
29	731616106071	SUBASHINI R	/	/	/	/	/	/	
30	731616106072	SUMATHI R	/	/	/	/	/	/	
31	731616106073	SURIYA E	/	/	/	/	/	/	
32	731616106074	SURYA R	/	/	/	/	/	/	

PRINCIPAL,
K. S. R. INSTITUTE FOR
ENGINEERING AND TECHNOLOGY,
K. S. R. KALVI NAGAR,
TIRUCHENGODE-637 215,
NAMAKKAL DI, TAMIL NADU.

Date of Training Programme			14.06.18		26.07.18		27.07.18	
S. No	Reg no	Name	FN	AN	FN	AN	FN	AN
33	731616106075	SYED SALMAN N	/	/	/	/	/	/
34	731616106076	TAMILARASI S	/	/	/	/	/	/
35	731616106077	THAMARA KANNAN A S	/	/	/	/	/	/
36	731616106078	THANGARAJ J	/	/	/	/	/	/
37	731616106079	THANGAVEL P	/	/	/	/	/	/
38	731616106080	THARANYA P	/	/	/	/	/	/
39	731616106081	VIGNESH P	/	/	/	/	/	/
40	731616106082	VIGNESH R	/	/	/	/	/	/
41	731616106083	VIMAL KUMAR R	/	/	/	/	a	a
42	731616106084	YOGESH S	/	/	/	/	/	/
43		NAVA NANDHINI	/	/	a	a	a	a
PRESENT			41	41	38	38	40	40
ABSENT			2	2	5	5	3	3
PERMISSION			-	-	-	-	-	-
OD			-	-	-	-	-	-
NI			-	-	-	-	-	-

PRINCIPAL
K. S. R. INSTITUTE FOR
ENGINEERING AND TECHNOLOGY,
K. S. R. KALVI NAGAR,
TIRUCHENGODE-637 215,
NAMAKKAL DI, TAMIL NADU.

IT - Internal Industry Readiness Training Programme, Programming Skills In Java & Advance Communication Skills Training Attendance

BATCH : 2016 - 2020

Academic Year: 2018 - 2019

Training Topics		Industry Readiness Training Programme	Advance Communication Skills					
Name of the Trainer		Dr.R.Nandakumar HoD / ECE	Dr.C.Muhuntarajan HoD/Eng					
Date of Training Programme			19.06.18		09.07.18		10.07.18	
S. No	Reg No	Name	FN	AN	FN	AN	FN	AN
1	731616205001	AHAMED FAISHAL H	/	/	/	/	/	/
2	731616205002	AJITH KUMAR M	/	/	/	/	/	/
3	731616205003	ARAVINDH K	/	a	/	/	/	/
4	731616205004	ARUN KUMAR A	/	/	/	/	/	/
5	731616205006	BOOPALAN G	/	/	/	/	/	/
6	731616205007	DEEPAN K	/	/	/	/	/	/
7	731616205008	GOPI S	/	/	a	a	L	L
8	731616205009	GOWRI D	/	/	/	/	/	/
9	731616205010	GOWTHAM D	a	/	a	a	/	/
10	731616205011	HAKKEM M	/	/	/	/	/	/
11	731616205012	INDHUMATHI S	/	/	/	/	/	/
12	731616205013	IYYAPPAN J	/	/	/	/	/	/
13	731616205014	JANANI M	/	/	/	/	/	/
14	731616205015	JANANI R	/	/	/	/	/	/
15	731616205016	JANANI T	/	/	/	/	/	/
16	731616205017	KARKULAZHI S	/	/	/	/	/	/
17	731616205018	KARTHIKA M	/	/	/	/	/	/
18	731616205019	KAUSALYA J	/	/	/	/	/	/
19	731616205020	KIRUBAKARAN R	/	/	/	/	/	/
20	731616205021	MANI BHARATHI G	/	/	/	/	/	/
21	731616205022	MOHANKUMAR M	/	/	/	/	/	/
22	731616205023	MOHANRAJ S	/	/	/	/	/	/
23	731616205024	MOUNIKA S	/	/	/	/	/	/
24	731616205025	NESHAK KUMAR S	a	/	/	/	/	/
25	731616205026	OVIYA A	/	/	L	L	L	L
26	731616205027	PRATHAP KUMAR E	/	/	/	/	/	/
27	731616205028	PRIYADARSHNI G	/	/	/	/	/	/
28	731616205029	SAKTHIRAVIKUMAR M	/	/	/	/	/	/
29	731616205030	SAM MCKENZIE R	/	a	/	/	/	/
30	731616205031	SARASWATHY K	/	/	/	/	/	/
31	731616205032	SATHAMHUSSAIN M S	/	/	/	/	/	/
32	731616205033	SATHAS R	/	/	/	/	/	/

PRINCIPAL
K. S. R. INSTITUTE FOR
ENGINEERING AND TECHNOLOGY,
K. S. R. KALVI NAGAR,
TIRUCHENGODE-637 215,
NAMAKKAL Dt, TAMIL NADU.

Date of Training Programme			19.06.18		09.07.18		10.07.18	
S. No	Reg No	Name	FN	AN	FN	AN	FN	AN
33	731616205034	STEEPEN V	1	1	L	L	1	1
34	731616205035	STEPHENRAJ J	1	1	1	1	1	1
35	731616205036	SUDARSAN S	1	a	1	1	1	1
36	731616205037	SUGITHA S	1	1	1	1	1	1
37	731616205038	SUMITHA J	1	1	1	1	1	1
38	731616205039	SWETHA S	1	1	1	1	1	1
39	731616205040	TAMILARASAN G	1	1	1	1	1	1
40	731616205041	VIGNESH M	1	1	1	1	1	1
41	731616205042	VIJI V	1	1	1	1	1	1
42	731616205043	VINOTH M	1	1	1	1	1	1
43	731616205044	YAKSHEETHA V	1	a	1	1	1	1
44	731616205045	YUVAPRIYA R	1	1	1	1	1	1
PRESENT			42	40	38	38	40	40
ABSENT			2	4	2	2	-	-
PERMISSION			-	-	2	2	2	2
OD			-	-	-	-	-	-
NOT INTEREST			-	-	-	-	-	-

 PRINCIPAL,
 K. S. R. INSTITUTE FOR
 ENGINEERING AND TECHNOLOGY,
 K. S. R. KALVI NAGAR,
 TIRUCHENGODE-637 215,
 NAMAKKAL DI, TAMIL NADU.

BATCH : 2016 - 2020

Academic Year: 2018 - 2019

Training Topics		Industry Readiness Training Programme				Advance Communication Skills				
Name of the Trainer		Dr.R.Nandakumar HoD / ECE				Dr.C.Muhuntarajan HoD/Eng				
Date of Trainng Programme			21.06.18		05.07.18		06.07.18			
S. No	Reg No	Name	FN	AN	FN	AN	FN	AN		
1	731616104001	AJITH KUMAR.P	/	/	/	/	/	/		
2	731616104002	AKILAN.Y	/	/	/	/	/	/		
3	731616104003	ANISHA.N	/	/	/	/	/	/		
4	731616104004	ARUN.R	/	/	/	/	/	/		
5	731616104005	BARATH.K	/	/	a	a	/	/		
6	731616104006	DEEPAK SURIYA.A	/	/	/	/	/	/		
7	731616104007	DEVADHARSHINI.S.S.	/	/	/	/	/	/		
8	731616104008	DEVI GAYATHRIS	NI							
9	731616104009	DHARANI.K	NI							
10	731616104010	GOWRIS	/	/	/	/	/	/		
11	731616104011	GOWTHAMAKUMARAN.P	/	/	/	/	a	a		
12	731616104012	HARINI.R	/	/	/	/	/	/		
13	731616104013	ILAKIYAS	/	/	/	/	/	/		
14	731616104014	INDHU.R	/	/	/	/	/	/		
15	731616104015	INDIRA PRIYADHARSHINI.P	/	/	/	/	/	/		
16	731616104016	JAYAVARSHINI.G	/	/	/	/	/	/		
17	731616104017	JEEVITHA.R	NI							
18	731616104018	KAMALESH.M	/	/	/	/	/	/		
19	731616104019	LAXMANCIBIS	/	/	/	/	/	/		
20	731616104020	MANIKANDAN.K	/	/	/	/	/	/		
21	731616104021	MANJULA.R	/	/	/	/	/	/		
22	731616104022	MEGASURIYAN.E	/	/	/	/	/	/		
23	731616104023	MOHAMMEDSAMIRA	/	/	/	/	/	/		
24	731616104024	NATHISH KUMARA	NI							
25	731616104026	PAVITHIRAN.S	/	/	/	/	/	/		
26	731616104027	PRAVEEN KUMAR.M	/	/	/	/	/	/		
27	731616104028	PREMNATH.R	/	/	/	/	/	/		
28	731616104030	PRIYANKA.V	NI							
29	731616104031	PUGAZHIVELAN.P	/	/	/	/	a	a		
30	731616104033	RAJARAJAN.A	/	/	/	/	/	/		
31	731616104034	SELVAMALINI.J	/	/	/	/	/	/		
32	731616104035	SHILPA.B	/	/	/	/	/	/		

 PRINCIPAL
 K. S. R. INSTITUTE FOR
 ENGINEERING AND TECHNOLOGY,
 K S R KALVINAGAR
 TIRUCHENGODE-637
 NAMAKKAL DE. THIRIL NALL

Date of Training Programme			21.06.18		05.07.18		06.07.18	
S. No	Reg No	Name	FN	AN	FN	AN	FN	AN
33	731616104036	SOUNDHARYA.A	/	/	/	/	/	/
34	731616104037	SRUTHI.S	/	/	/	/	/	/
35	731616104038	STELINBERCIA.S	a	a	/	/	/	/
36	731616104039	SUBHASREE.S	NI					
37	731616104040	SWETHA.B	/	/	/	/	/	/
38	731616104041	SWETHA.C	/	/	/	/	/	/
39	731616104042	VASU MITHA.R.S	/	/	/	/	/	/
40	731616104043	VELU PRABHAS	/	/	/	/	/	/
41	731616104044	VENKATESH.M	NI					
42	731616104045	VENMATHI.S	/	/	/	/	/	/
43	731616104046	VIGNESH.G	/	/	/	/	/	/
44	731616104047	VISVESWARAN.B	/	/	/	/	/	/
45	731616104048	YUVAPRIYANKA.V	/	/	/	/	/	/
46	731616104006	DEEPAK SURIYA.A	/	/	/	/	/	/
47	731616104008	DEVI GAYATHRI.S	/	/	/	/	/	/
48	731616104009	DHARANI.K	/	/	/	/	/	/
49	731616104017	JEEVITHA.R	/	/	/	/	/	/
50	731616104024	NATHISH KUMARA	/	/	/	/	/	/
51	731616104030	PRIYANKA.V	/	/	/	/	/	/
52	731616104039	SUBHASREE.S	/	/	/	/	/	/
53	731616104044	VENKATESH.M	/	/	/	/	a	a
54		Gayathri	a	a	/	/	/	/
PRESENT			40	40	43	43	41	41
ABSENT			2	2	1	1	3	3
PERMISSION			2	2	-	-	-	-
OD			-	-	-	-	-	-
NOT INTEREST			10	10	10	10	10	10

 PRINCIPAL
 K. S. R. INSTITUTE FOR
 ENGINEERING AND TECHNOLOGY,
 K. S. R. KALVI NAGAR,
 TIRUCHENGODE-637 215,
 NAMAKKAL Dt, TAMIL NADU.

MECH A- Internal Industry Readiness Training Programme & Advance Communication Skills Attendance

BATCH : 2016 - 2020

Academic Year: 2018 - 2019

Training Topics		Industry Readiness Training Programme				Advance Communication Skills			
Name of the Trainer		Dr.R.Nandakumar HoD / ECE				Dr.C.Muhuntarajan HoD/Eng			
Date of Training Programme			30.07.18		31.07.18		29.08.18		
S. No	Reg No	Name	FN	AN	FN	AN	FN	AN	
1	731616114001	AAKASH S							
2	731616114002	AJITH M							
3	731616114003	ANNAMALAI K	/	/	/	/	/	/	
4	731616114004	ARSHATH S	/	/	/	/	/	/	
5	731616114005	ASWINKUMAR S	a	a					
6	731616114006	BHARATH V							
7	731616114007	BOOPATHI RAJA E	/	/	/	/	/	/	
8	731616114008	BOOPATHY K M							
9	731616114009	CHANDRASEKAR K							
10	731616114010	CHELLATHURAI T							
11	731616114011	DEEPAK R	/	/	/	/	/	/	
12	731616114012	DHAYANIDHI M	/	/	/	/	/	/	
13	731616114013	DHEVENDRAN E	/	/	a	a	/	/	
14	731616114014	DHINAKARAN P							
15	731616114015	DINESH KUMAR C	/	/	/	/	/	/	
16	731616114016	GOKUL R							
17	731616114017	GOKULRAJ P	/	/	/	/	/	/	
18	731616114018	GOPINATH G	/	/	/	/	/	/	
19	731616114019	GOVINDASAMY A	/	/	/	/	/	/	
20	731616114020	GOWTHAM P							
21	731616114021	GUNASEKARAN R	/	/	/	/	P	P	
22	731616114022	HARIHARAN M	/	/	/	/	/	/	
23	731616114023	HARIHARAN S	/	/	/	/	/	/	
24	731616114024	HARI SHANKAR P	/	/	/	/	/	/	
25	731616114025	INBARASAN C	/	/	/	/	/	/	
26	731616114027	JAYAMURUGAN K S	/	/	/	/	/	/	
27	731616114028	JEEVA K	/	/	/	/	/	/	
28	731616114029	JEEVA M	/	/	/	/	/	/	
29	731616114030	JESTINRAJ K	/	/	/	/	/	/	
30	731616114031	JOSHUA Y	/	/	/	/	/	/	
31	731616114032	KALEESWARAN D	/	/	/	/	/	/	
32	731616114033	KAROLE INFANTO D	/	/	/	/	/	/	

PRINCIPAL,
K. S. R. INSTITUTE FOR
ENGINEERING AND TECHNOLOGY,
K. S. R. KALVI NAGAR,
TIRUCHENGODE-637 215,
NAMAKKAL DI, TAMIL NADU.

Date of Training Programme			30.07.18		31.07.18		29.08.18	
S. No	Reg No	Name	FN	AN	FN	AN	FN	AN
33	731616114034	KARTHIKEYAN P	/	/	/	/	/	/
34	731616114035	KAVIN P	/	/	/	/	/	/
35	731616114036	KAVINKUMAR R	NI					
36	731616114037	KEERTHIVASAN S	NI					
37	731616114038	KESAV GOUTHAM N B	/	/	/	/	/	/
38	731616114040	KIRUBAKARAN M	/	/	/	/	/	/
39	731616114041	LAKSHMI NARAYANAN R	/	/	/	/	/	/
40	731616114042	LOGESH N	/	/	/	/	/	/
41	731616114043	LOGESH S	/	/	/	/	/	/
42	731616114044	MADHANKUMAR L	/	/	/	/	/	/
43	731616114045	MAGESWARAN A	/	/	a	a	/	/
44	731616114046	MANIKANDAN V	/	/	/	/	/	/
45	731616114047	MANOJKUMAR K	/	/	/	/	/	/
46	731616114048	MOHAMMED NIHAL R	/	/	/	/	/	/
47	731616114049	MOHANAKRISHNAN D	a	a	/	/	/	/
48	731616114050	MOHAN ARJUN KUMARAVEL	/	/	/	/	/	/
49	731616114051	MOHANRAJ B	/	/	/	/	/	/
50	731616114302	BALAJI M	/	/	/	/	/	/
51	731616114303	BARATH V	NI					
52	731616114304	ETHAYAKUMAR G	NI					
53	731616114305	JEEVANANDHAM N	/	/	/	/	/	/
54	731616114306	KARTHI S	/	/	/	/	/	/
55	731616114308	PRASANTH S	/	/	/	/	/	/
PRESENT			53	53	53	53	54	54
ABSENT			2	2	2	2	-	-
PERMISSION			0	0	0	0	1	1
OD								
NI								

 PRINCIPAL
 K. S. R. INSTITUTE FOR
 ENGINEERING AND TECHNOLOGY
 K. S. R. KALVI NAGAR,
 TIRUCHENGODE-637 216,
 NAMAKKAL DISTRICT, TAMIL NADU

BATCH : 2016 - 2020

Academic Year: 2018 - 2019

Training Topics		Industry Readiness Training Programme				Advance Communication Skills				
Name of the Trainer		Dr.R.Nandakumar HoD / ECE				Dr.C.Muhuntarajan HoD/Eng				
Date of Training Programme			24.07.18 24.07.18		12.07.18		13.07.18			
S. No	Reg No	Name	FN	AN	FN	AN	FN	AN		
1	731616105002	AJITHA P	/	/	/	/	/	/		
2	731616105003	AKILAN G	/	/	a	a	/	/		
3	731616105004	ANBALAGAN M	/	/	/	/	/	/		
4	731616105005	ARAVIND R	/	/	/	/	/	/		
5	731616105006	BHARATH S	/	/	/	/	/	/		
6	731616105007	BHARATHI KANNAN M R	/	/	/	/	/	/		
7	731616105008	BOOPATHI M	/	/	/	/	/	/		
8	731616105010	DIVYADEVI V	/	/	/	/	/	/		
9	731616105011	GANESHBABU V	/	/	/	/	a	a		
10	731616105012	INIYA DHARINI R	/	/	/	/	/	/		
11	731616105013	JANANI T	NI							
12	731616105014	JEEVA M	/	/	/	/	/	/		
13	731616105015	JEEVA R	/	/	/	/	/	/		
14	731616105016	KAMALI SOUNDARYA B	/	/	/	/	/	/		
15	731616105017	KANIMOZHI V	/	/	/	/	/	/		
16	731616105018	KARTHIKA DEVI S	/	/	/	/	/	/		
17	731616105019	KAVINKUMAR K	/	/	/	/	/	/		
18	731616105020	KAVIYA M	/	/	/	/	/	/		
19	731616105021	LATHA S	/	/	/	/	/	/		
20	731616105022	LOGESHWARAN V	/	/	/	/	/	/		
21	731616105023	MADHUMITHA J S	/	/	/	/	/	/		
22	731616105024	MANOJKUMAR V	/	/	/	/	/	/		
23	731616105025	MATHUBALAN S	/	/	a	a	a	a		
24	731616105026	MERLIN INFANTA S	/	/	/	/	/	/		
25	731616105027	MOHANRAJ S	/	/	/	/	/	/		
26	731616105028	MONISHA S	/	/	/	/	/	/		
27	731616105029	MUGESH M	a	a	/	/	/	/		
28	731616105030	MYTHILI N	/	/	/	/	/	/		
29	731616105031	NANCY ASMITHA P A	/	/	/	/	a	a		
30	731616105032	NANDHINI M	/	/	/	/	/	/		
31	731616105033	NAVANEETHAN S	/	/	/	/	/	/		
32	731616105034	NITHIYASRI R	/	/	/	/	/	/		

PRINCIPAL.
K. S. R. INSTITUTE FOR
ENGINEERING AND TECHNOLOGY,
K. S. R. KALVI NAGAR,
TIRUCHENGODE-637 215,
NAMAKKAL DI, TAMIL NADU.

Date of Training Programme			24.07.18 20.06.18		12.07.18		13.07.18	
S. No	Reg No	Name	FN	AN	FN	AN	FN	AN
33	731616105035	PIREETHI.A	1	1	1	1	1	1
34	731616105036	PRAKASH.S.P	P	P	1	1	1	1
35	731616105037	PRAVEEN.D	1	1	1	1	1	1
36	731616105038	PRAVIN.R	1	1	1	1	1	1
37	731616105039	PREETHA.E	1	1	1	1	1	1
38	731616105040	PREMKUMAR.G	1	1	1	1	1	1
39	731616105041	SARANYA.P	1	1	1	1	1	1
40	731616105042	SARAVANAN.V	1	1	1	1	1	1
41	731616105043	SHANKAR NARAYAN.M	1	1	P	P	P	P
42	731616105044	SIBIN.S	1	1	P	P	P	P
43	731616105045	SUJITHA.E	1	1	1	1	1	1
44	731616105046	SUVETHA.T	1	1	1	1	1	1
45	731616105047	VIVEK.V	1	1	1	1	1	1
46	731616105301	DINESHKUMAR. S	1	1	1	1	1	1
47	731616105302	EDISON RAJA.R	1	1	a	a	1	1
48	731616105303	EMAIYA.K	1	1	1	1	1	1
49	731616105304	HARIHARAN.R	1	1	1	1	1	1
50	731616105305	KARTHI.K	1	1	1	1	1	1
51	731616105306	RATHNAKUMAR.V	1	1	1	1	1	1
52	731616105701	GOKUL RAJ .M	1	1	1	1	a	a
PRESENT			49	49	46	46	45	45
ABSENT			1	1	3	3	4	4
PERMISSION			1	1	2	2	2	2
OD			-	-	-	-	-	-
NOT INTEREST			1	1	1	1	1	1

 PRINCIPAL
 K. S. R. INSTITUTE FOR
 ENGINEERING AND TECHNOLOGY,
 K. S. R. KALVI NAGAR,
 TIRUCHENGODE-637 215,
 PERIYAKKALDI, TAMIL NADU.

Training and Placement Cell

MECH B- Internal Industry Readiness Training Programme & Advance Communication Skills Attendance

BATCH : 2016 - 2020

Academic Year: 2018 - 2019

Training Topics		Industry Readiness Training Programme				Advance Communication Skills				
Name of the Trainer		Dr.R.Nandakumar HoD / ECE				Dr.C.Muhuntarajan HoD/Eng				
Date of Training Programme			28.06.18 31.8.2018		06.08.18		07.08.18			
S. No	Reg No	Name	FN	AN	FN	AN	FN	AN		
1	731616114052	NAMBIRAJ J	/	/	/	/	a	a		
2	731616114053	NANDHA GOBAL S	/	/	/	/	/	/		
3	731616114054	NAVINKUMAR M	/	/	/	/	/	/		
4	731616114055	PARTHASARATHY R	/	/	a	a	/	/		
5	731616114056	PRABAKARAN S	/	/	/	/	/	/		
6	731616114057	PRABHAKARAN M	/	/	/	/	/	/		
7	731616114058	PRASANTH R	/	/	/	/	/	/		
8	731616114059	PRAVEEN R (07.01.1999)	a	a	/	/	/	/		
9	731616114060	PRAVEEN R (31.03.1999)	/	/	/	/	L	L		
10	731616114061	PRAVEENKUMAR S	/	/	/	/	/	/		
11	731616114063	RAGAVENDHAR S	/	/	/	/	/	/		
12	731616114064	RAHUL C	/	/	/	/	/	/		
13	731616114065	RAJKUMAR S	/	/	/	/	L	/		
14	731616114066	RANJITH R	/	/	/	/	/	/		
15	731616114067	RANJITHKUMAR R	/	/	/	/	/	/		
16	731616114068	RANJITH KUMAR V	/	/	/	/	/	/		
17	731616114069	RAVICHANDRAN S	/	/	/	/	/	/		
18	731616114070	RIYAZ AHAMED S	/	/	/	/	/	/		
19	731616114071	RUTHRANNAN B	/	/	/	/	/	/		
20	731616114072	SABARISH R(H)	a	a	/	/	/	/		
21	731616114073	SAKTHI GNANASUNDARAM R H	/	/	/	/	/	/		
22	731616114074	SAKTHIVEL R	/	/	/	/	/	/		
23	731616114075	SANJAY KUMAR S	/	/	/	/	/	/		
24	731616114076	SANJAY KUMAR S K	/	/	/	/	/	/		
25	731616114077	SANTHOSH KUMAR B	/	/	a	a	/	/		
26	731616114078	SANTHOSH KUMAR V	/	/	/	/	/	/		
27	731616114079	SARAN K	/	/	/	/	/	/		
28	731616114080	SARANRAJ S	/	/	/	/	/	/		
29	731616114081	SATHISH G	/	/	/	/	/	/		
30	731616114082	SHAKTHI R M	NI							
31	731616114083	SOWNDHAR A	/	/	/	/	/	/		
32	731616114084	SURYA R	NI							

PRINCIPAL.
K. S. R. INSTITUTE FOR
ENGINEERING AND TECHNOLOGY,
K. S. R. KALVI NAGAR,
TIRUCHENGODE-637 215,
NAMAKKAL Dt, TAMIL NADU.

Date of Training Programme			28.06.18		06.08.18		07.08.18		
S. No	Reg No	Name	FN	AN	FN	AN	FN	AN	
33	731616114085	TAMILMUGILAN N	/	/	/	/	/	/	
34	731616114086	THAMOTHARAN J	/	/	/	/	/	/	
35	731616114087	THIRUMURUGAN V	/	/	/	/	/	/	
36	731616114088	UTHAYA KUMAR M	/	/	/	/	/	/	
37	731616114090	VASANTHAKUMAR P	/	/	/	/	L	L	
38	731616114091	VELMURUGAN T	/	/	/	/	/	/	
39	731616114092	VIGNESH B	NI						
40	731616114093	VIGNESH V	/	/	/	/	/	/	
41	731616114094	VIJAY ANAND G	/	/	/	/	/	/	
42	731616114095	VIJAYARAGAVAN P	/	/	/	/	/	/	
43	731616114096	VINOTHMANI M	/	/	/	/	/	/	
44	731616114097	VISHNU A	L	L	/	/	/	/	
45	731616114098	VIVEK P	/	/	/	/	/	/	
46	731616114099	YOGARAJ.G	/	/	/	/	/	/	
47	731616114100	YOGESH T	/	/	/	/	/	/	
48	731616114307	PRAKASH S	/	/	/	/	/	/	
49	731616114309	SANJEEVI K P	/	/	/	/	L	L	
50	731616114310	SHANMUGAMANIVEL D	/	/	/	/	/	/	
51	731616114311	SURENDHAR J	/	/	/	/	/	/	
PRESENT			49	49	46	46	48	48	
ABSENT			2	2	1	1	2	2	
PERMISSION			-	-	4	4	1	1	
OD			-	-	-	-			
NI									

 PRINCIPAL,
 K. S. R. INSTITUTE FOR
 ENGINEERING AND TECHNOLOGY,
 K. S. R. KALVI NAGAR,
 TIRUCHENGODE-637 215,
 NAMAKKAL Dt, TAMIL NADU.

Internal Industry Readiness Programme, Basic Communication & Programming In java Training
Attendance

BATCH: 2016 - 2020

ACADEMIC YEAR: 2018 - 2018 (ODD)

DATE: 12.06.2018

Fore Noon session

S.NO	BRANCH	STRENGTH	PRESENT	ABSENT	Leave	NI
1	ECE A	41	33	8	0	0
Total		41	33	8	0	0

After Noon Session

S.NO	BRANCH	STRENGTH	PRESENT	ABSENT	Leave	NI
1	ECE A	41	33	8	0	0
Total		41	33	8	0	0

BATCH: 2016 - 2020

ACADEMIC YEAR: 2018 - 2018 (ODD)

DATE: 14.06.2018

Fore Noon session

S.NO	BRANCH	STRENGTH	PRESENT	ABSENT	Leave	NI
1	ECE B	45	39	2	0	4
Total		45	39	2	0	4

After Noon Session

S.NO	BRANCH	STRENGTH	PRESENT	ABSENT	Leave	NI
1	ECE B	45	39	2	0	4
Total		45	39	2	0	4

R. J. Jeyanth
T & P OFFICER

[Signature]
T & P CO ORDINATOR

[Signature]
PRINCIPAL

PRINCIPAL,
K. S. R. INSTITUTE FOR
ENGINEERING AND TECHNOLOGY,
K. S. R. KALVI NAGAR,
TIRUCHENGODE-637 215,
NAMAKKAL DI, TAMIL NADU.

TRAINING & PLACEMENT CELL



Internal Industry Readiness Programme, Basic Communication & Programming In java Training
Attendance

BATCH: 2016 - 2020

ACADEMIC YEAR: 2018 - 2019 (ODD)

DATE: 19.06.2018

Fore Noon session

S.NO	BRANCH	STRENGTH	PRESENT	ABSENT	Leave	NI
1	IT	44	42	2	0	0
Total		44	42	2	0	0

BATCH: 2016 - 2020

ACADEMIC YEAR: 2018 - 2018 (ODD)

DATE: 20.06.2018

After Noon session

S.NO	BRANCH	STRENGTH	PRESENT	ABSENT	Leave	NI
1	IT	44	40	4	0	0
Total		44	40	4	0	0

[Signature]
T&P OFFICER

[Signature]
T&P CO ORDINATOR

[Signature]
PRINCIPAL

PRINCIPAL,
K. S. R. INSTITUTE FOR
ENGINEERING AND TECHNOLOGY,
K. S. R. KALVI NAGAR,
TIRUCHENGODE-637 215,
NAMAKKAL Dt, TAMIL NADU.

TRAINING & PLACEMENT CELL



Internal **Industry Readiness Programme**, Basic Communication & Programming In java Training
Attendance

BATCH: 2016 - 2020

ACADEMIC YEAR: 2018 - 2018 (ODD)

DATE: 21.06.2018

Fore Noon session

S.NO	BRANCH	STRENGTH	PRESENT	ABSENT	Leave	NI
1	CSE	54	40	2	2	10
Total		54	40	2	2	10

After Noon Session

S.NO	BRANCH	STRENGTH	PRESENT	ABSENT	Leave	NI
1	CSE	54	40	2	2	10
Total		54	40	2	2	10

[Signature]
T & P OFFICER

[Signature]
21/6/18
T&P CO ORDINATOR

[Signature]
PRINCIPAL

[Green Checkmark]
PRINCIPAL.
K. S. R. INSTITUTE FOR
ENGINEERING AND TECHNOLOGY,
K. S. R. KALVI NAGAR,
TIRUCHENGODE-637 215,
NAMAKKAL DI, TAMIL NADU.

Fore Noon session

S.NO	BRANCH	STRENGTH	PRESENT	ABSENT	Leave	NI
1	CSE	54	43	1	0	10
Total		54	43	1	0	10

After Noon Session

S.NO	BRANCH	STRENGTH	PRESENT	ABSENT	Leave	NI
1	CSE	54	43	1	0	10
Total		54	43	1	0	10

Fore Noon session

S.NO	BRANCH	STRENGTH	PRESENT	ABSENT	Leave	NI
1	CSE	54	41	3	0	10
Total		54	41	3	0	10

After Noon Session

S.NO	BRANCH	STRENGTH	PRESENT	ABSENT	Leave	NI
1	CSE	54	41	3	0	10
Total		54	41	3	0	10

[Signature]
T & P OFFICER

[Signature]
T&P CO ORDINATOR

[Signature]
PRINCIPAL

PRINCIPAL
K. S. R. INSTITUTE FOR
ENGINEERING AND TECHNOLOGY,
K. S. R. KALVI NAGAR,
TIRUCHENGODE-637 215,
NAMAKKAL DI, TAMIL NADU.

Fore Noon session

S.NO	BRANCH	STRENGTH	PRESENT	ABSENT	Leave
1	IT	42	38	2	2
Total		42	38	2	2

After Noon Session

S.NO	BRANCH	STRENGTH	PRESENT	ABSENT	Leave
1	IT	42	38	2	2
Total		42	38	2	2

Fore Noon session

S.NO	BRANCH	STRENGTH	PRESENT	ABSENT	Leave
1	IT	42	40	0	2
Total		42	40	0	2

After Noon Session

S.NO	BRANCH	STRENGTH	PRESENT	ABSENT	Leave
1	IT	42	40	0	2
Total		42	40	0	2

[Signature]
T & P OFFICER

[Signature]
T&P CO ORDINATOR

[Signature]

[Signature]
PRINCIPAL

PRINCIPAL.
K. S. R. INSTITUTE FOR
ENGINEERING AND TECHNOLOGY,
K. S. R. KALVI NAGAR,
TIRUCHENGODE-637 215,
NAMAKKAL DI, TAMIL NADU.



Internal Industry Readiness Programme, **Basic Communication** & Programming In java
Training Attendance

BATCH: 2016 - 2020

ACADEMIC YEAR: 2018 - 2019 (ODD)

DATE: 12.07.2018

Fore Noon session

S.NO	BRANCH	STRENGTH	PRESENT	ABSENT	OD	NI
1	EEE	52	46	3	2	1
Total		52	46	3	2	1

After Noon Session

S.NO	BRANCH	STRENGTH	PRESENT	ABSENT	OD	NI
1	EEE	52	46	3	2	1
Total		52	46	3	2	1

BATCH: 2016 - 2020

ACADEMIC YEAR: 2018 - 2019 (ODD)

DATE: 13.07.2018

Fore Noon session

S.NO	BRANCH	STRENGTH	PRESENT	ABSENT	OD	NI
1	EEE	52	45	4	2	1
Total		52	45	4	2	1

After Noon Session

S.NO	BRANCH	STRENGTH	PRESENT	ABSENT	OD	NI
1	EEE	52	45	4	2	1
Total		52	45	4	2	1

[Signature]
T & P OFFICER

[Signature]
T&P CO ORDINATOR

[Signature]
PRINCIPAL
K. S. R. INSTITUTE FOR
ENGINEERING AND TECHNOLOGY,
K. S. R. KALVI NAGAR,
TIRUCHENGODE-637 215,
NAMAKKAL DI, TAMIL NADU.

TRAINING & PLACEMENT CELL



Internal Industry Readiness Programme, **Basic Communication** & Programming In java
Training Attendance

BATCH: 2016 - 2020

ACADEMIC YEAR: 2018 - 2019 (ODD)

DATE: 23.07.2018

Fore Noon session

S.NO	BRANCH	STRENGTH	PRESENT	ABSENT	Leave	NI
1	ECE A	41	40	1	0	0
Total		41	40	1	0	0

After Noon Session

S.NO	BRANCH	STRENGTH	PRESENT	ABSENT	Leave	NI
1	ECE A	41	40	1	0	0
Total		41	40	1	0	0

BATCH: 2016 - 2020

ACADEMIC YEAR: 2018 - 2019 (ODD)

DATE: 24.07.2018

Fore Noon session

S.NO	BRANCH	STRENGTH	PRESENT	ABSENT	Leave	NI
1	ECE A	41	40	1	0	0
Total		41	40	1	0	0

After Noon Session

S.NO	BRANCH	STRENGTH	PRESENT	ABSENT	Leave	NI
1	ECE A	41	40	1	0	0
Total		41	40	1	0	0

[Signature]
T & P OFFICER

[Signature]
23/7/18
T&P CO ORDINATOR

[Signature]
PRINCIPAL,
K. S. R. INSTITUTE FOR
ENGINEERING AND TECHNOLOGY,
K. S. R. KALVI NAGAR,
TIRUCHENGODE-637 215,
NAMAKKAL DL, TAMIL NADU.

[Signature]
PRINCIPAL

TRAINING & PLACEMENT CELL



Internal Industry Readiness Programme, **Advance Communication** & Programming In java
Training Attendance

BATCH: 2016 - 2020

ACADEMIC YEAR: 2018 - 2019 (ODD)

DATE: 30.07.2018

Fore Noon session

S.NO	BRANCH	STRENGTH	PRESENT	ABSENT	PERMISSION	NI
1	MECH A	55	40	2	0	13
Total		55	40	2	0	13

After Noon Session

S.NO	BRANCH	STRENGTH	PRESENT	ABSENT	PERMISSION	NI
1	MECH A	55	40	2	0	13
Total		55	40	2	0	13

BATCH: 2016 - 2020

ACADEMIC YEAR: 2018 - 2019 (ODD)

DATE: 31.07.2018

Fore Noon session

S.NO	BRANCH	STRENGTH	PRESENT	ABSENT	PERMISSION	NI
1	MECH A	55	41	0	1	13
Total		55	41	0	1	13

After Noon Session

S.NO	BRANCH	STRENGTH	PRESENT	ABSENT	PERMISSION	NI
1	MECH A	55	41	0	1	13
Total		55	41	0	1	13

V. Kalvi
T & P OFFICER

[Signature]
20/07/18
T&P CO ORDINATOR

[Signature]
PRINCIPAL
K. S. R. INSTITUTE FOR
ENGINEERING AND TECHNOLOGY,
K. S. R. KALVI NAGAR,
TIRUCHENGODE-637 215,
NAMAKKAL DI, TAMIL NADU.

TRAINING & PLACEMENT CELL



Internal Industry Readiness Programme, Advance Communication & Programming In java
Training Attendance

BATCH: 2016 - 2020

ACADEMIC YEAR: 2018 - 2019 (ODD)

DATE: 06.08.2018

Fore Noon session

S.NO	BRANCH	STRENGTH	PRESENT	ABSENT	PERMISSIO N	NI
1	MECH B	51	46	2	0	3
Total		51	46	2	0	3

After Noon Session

S.NO	BRANCH	STRENGTH	PRESENT	ABSENT	PERMISSIO N	NI
1	MECH B	51	46	2	0	3
Total		51	46	2	0	3

BATCH: 2016 - 2020

ACADEMIC YEAR: 2018 - 2019 (ODD)

DATE: 07.08.2018

Fore Noon session

S.NO	BRANCH	STRENGTH	PRESENT	ABSENT	Leave	NI
1	MECH B	51	43	1	4	3
Total		51	43	1	4	3

After Noon Session

S.NO	BRANCH	STRENGTH	PRESENT	ABSENT	Leave	NI
1	MECH B	51	43	1	4	3
Total		51	43	1	4	3

P. Lakshmi
T & P OFFICER

[Signature]
T&P CO ORDINATOR

[Signature]
PRINCIPAL

[Signature]
PRINCIPAL

K. S. R. INSTITUTE FOR
ENGINEERING AND TECHNOLOGY,
K. S. R. KALVI NAGAR,
TIRUCHENGODE-637 215,
NAMAKKAL Dt, TAMIL NADU,

BATCH: 2016 - 2020

ACADEMIC YEAR: 2018 - 2019 (ODD)

DATE: 13.08.2018

Fore Noon session

S.NO	BRANCH	STRENGTH	PRESENT	ABSENT	PERMISSION	NI
1	ECE B	42	38	4	0	0
Total		42	38	4	0	0

After Noon Session

S.NO	BRANCH	STRENGTH	PRESENT	ABSENT	PERMISSION	NI
1	ECE B	42	38	4	0	0
Total		42	38	4	0	0

BATCH: 2016 - 2020

ACADEMIC YEAR: 2018 - 2019 (ODD)

DATE: 14.08.2018

Fore Noon session

S.NO	BRANCH	STRENGTH	PRESENT	ABSENT	Leave	NI
1	ECE B	42	40	2	0	0
Total		42	40	2	0	0

After Noon Session

S.NO	BRANCH	STRENGTH	PRESENT	ABSENT	Leave	NI
1	ECE B	42	40	2	0	0
Total		42	40	2	0	0

[Signature]
T & P OFFICER
28/8

[Signature]
T&P CO ORDINATOR

[Signature]
PRINCIPAL
K. S. R. INSTITUTE FOR ENGINEERING AND TECHNOLOGY,
K. S. R. KALVI NAGAR,
TIRUCHENGODE-637 215,
NAMAKKAL Dt, TAMIL NADU.

TRAINING & PLACEMENT CELL



Internal Industry Readiness Programme, Basic Communication & Programming In java
Training Attendance

BATCH: 2016 - 2020

ACADEMIC YEAR: 2018 - 2019 (ODD)

DATE: 24.08.2018

Fore Noon session

S.NO	BRANCH	STRENGTH	PRESENT	ABSENT	OD	NI
1	EEE	52	49	1	1	1
Total		52	49	1	1	1

After Noon Session

S.NO	BRANCH	STRENGTH	PRESENT	ABSENT	OD	NI
1	EEE	52	49	1	1	1
Total		52	49	1	1	1

T & P OFFICER

T & P CO ORDINATOR

PRINCIPAL

PRINCIPAL.
K. S. R. INSTITUTE FOR
ENGINEERING AND TECHNOLOGY,
K. S. R. KALVI NAGAR,
TIRUCHENGODE-637 215,
NAMAKKAL DI, TAMIL NADU.



Fore Noon session

S.NO	BRANCH	STRENGTH	PRESENT	ABSENT	PERMISSION	NI
1	MECH A	55	40	2	0	13
Total		55	40	2	0	13

After Noon Session

S.NO	BRANCH	STRENGTH	PRESENT	ABSENT	PERMISSION	NI
1	MECH A	55	40	2	0	13
Total		55	40	2	0	13

Fore Noon session

S.NO	BRANCH	STRENGTH	PRESENT	ABSENT	Leave	NI
1	MECH B	51	45	2	1	3
Total		51	45	2	1	3

After Noon Session

S.NO	BRANCH	STRENGTH	PRESENT	ABSENT	Leave	NI
1	MECH B	51	45	2	1	3
Total		51	45	2	1	3

T & P OFFICER

T&P CO ORDINATOR

PRINCIPAL.

PRINCIPAL

K. S. R. INSTITUTE FOR
ENGINEERING AND TECHNOLOGY,
K. S. R. KALVI NAGAR,
TIRUCHENGODE-637 215,
NAMAKKAL Dt, TAMIL NADU.

**K S R INSTITUTE FOR ENGINEERING AND TECHNOLOGY
TIRUCHENGODE - 637 215**

TRAINING PROGRAMME FEEDBACK FORM



Name of the Student: S. Nivetha Branch: ECE

Year / Sem: 3rd / odd

1. Name of the Training: Industry Readiness programme

2. Name of the Trainer: Dr. R. Nandhakumar HOD / ECE

3. Students rating of Trainers: 10/10

S. No.	Date	Subject	Rating (✓)			
			Excellent	Very good	Good	Average
1	14.6.18	Industry Readiness Programme		✓		

4. Two positive points about the programme:

To Develop communication skills,
Upgrade our energy.

5. Suggestions for improvement:

Nothing.

Date: 14.6.18

S. Nivetha
Signature

**K S R INSTITUTE FOR ENGINEERING AND TECHNOLOGY
TIRUCHENGODE - 637 215**

TRAINING PROGRAMME FEEDBACK FORM



Name of the Student: R. Shyam Sundar Branch: ECE

Year / Sem: 3rd / odd

4. Name of the Training: Industry Readiness Programme

5. Name of the Trainer: Dr. R. Nandhakumar HOD / ECE

6. Students rating of Trainers: 10/10

S. No.	Date	Subject	Rating (✓)			
			Excellent	Very good	Good	Average
1	14.06.18	Industry Readiness Programme			✓	

4. Two positive points about the programme:

+ To develop communication skills
+ self confidence.

5. Suggestions for improvement:

Nothing.

Date: 14.06.18

PRINCIPAL,
K. S. R. INSTITUTE FOR
ENGINEERING AND TECHNOLOGY,
K. S. R. KALVI NAGAR,
TIRUCHENGODE-637 215
NAMAKKAL Dt, TAMIL NADU

[Signature]
Signature

REPORT ON COMMUNICATION SKILLS TRAINING

Submitted to:

The Principal,
K S R Institute for Engineering and Technology,
Tiruchengode – 637215.

Submitted through:

Dr. R. Nandakumar,
Training and Placement Coordinator,
K S R Institute for Engineering and Technology,
Tiruchengode – 637215.

Submitted by:

Dr. C. Muhuntarajan,
Associate Professor and Head,
Department of English,
K S R Institute for Engineering and Technology,
Tiruchengode – 637215.

Date: 16.08.2018

Dear Sir,

In the completion of the Placement Training Programme for II & III Year Students, I submit you the detailed Report with my findings, suggestions and next plan to proceed. The details of the Training Programme are mentioned below for your kind reference.

Topics : Basic Communication Skills (II Year)
Advanced Communication Skills (III Year)

No. of Classes : 7 (II Year)
7 (III Year)

No. of Days : 14 days (II Year) – 2 days for each class
14 days (III Year) – 2 days for each class

Dates : 14.06.2018 to 14.08.2018

Venue : ECE Seminar Hall & EEE Seminar Hall

Materials : Handbook (Photocopied)

Tools Used : PPTs, Audios & Videos

PRINCIPAL,
K. S. R. INSTITUTE FOR
ENGINEERING AND TECHNOLOGY,
K. S. R. KALVI NAGAR,
TIRUCHENGODE-637 215,
NAMAKKAL DI, TAMIL NADU.

Students were given the Basic Communication Skills and Advanced Communication Skills Training with the support of a photocopied Handbook which covered the essential contents of the training. The sessions were mixed with PPTs, Activities, Interactions, Audio & Video Clippings, etc. They were grouped with different teams and all of them had a chance to come out for participation. Some of them were motivated if they have any hesitation to speak. They were also given complete freedom to make fun, pass comments loudly and speak comfortably. On the whole, all the students enjoyed the amicable ambience.

Findings:

Positives:

- Good attendance record
- Everyone maintained discipline, punctuality and dress code
- Everyone enjoyed the freedom and the comfort
- Many students were very much interactive
- Many actively participated in all the activities
- 90% of students were very receptive
- Everyone realized the importance of the Communication Skills
- Many came out of stage fear and talked on stage

Negatives:

- Not updated with the current affairs
- Not volunteer participation
- Hesitation to mingle and discuss with new friends
- Not regular Speaking practice
- Very average in vocabulary

Suggestions:

- Students should be given continuous speaking practices
- Awareness should be created on updating the current affairs
- A perfect platform should be created to show and improve their ability

The Next Plan

As per the directions given by Dr. R. Nandakumar sir, 15 students from each class have been identified. They have to be taken out during their S2D Classes, we should create a space and healthy competition among those creamy students. Approximately 100 students from II Year and 100 students from III Year can be moulded effectively to perform well in their Campus Interviews.

 Thanking you,

Yours truly,

 16/8/18
(Dr. C. MUHUNTARAJAN)

 16/8/18
PRINCIPAL,
K. S. R. INSTITUTE FOR
ENGINEERING AND TECHNOLOGY,
K. S. R. KALVI NAGAR,
TIRUCHENGODE-637 215,
NAMAKKAL DISTRICT, TAMIL NADU.

Name of the Student: J. S. MadhumithaBranch: III - EEEYear / Sem: III / V1. Name of the Training: Communication Skills2. Name of the Trainer: MUGUNTHA RAJAN

3. Students rating of Trainers :

S. No.	Date	Subject	Rating (✓)			
			Excellent	Very good	Good	Average
1	12/07/18	Communication	✓			

4. Two positive points about the programme:

Good interaction with students

5. Suggestions for improvement:

-

Date: 12/7/18

Signature

Name of the Student: Karthika Devi SBranch: III EEEYear / Sem: III / IV4. Name of the Training: communication skills5. Name of the Trainer: Muguntharajan

6. Students rating of Trainers :

S. No.	Date	Subject	Rating (✓)			
			Excellent	Very good	Good	Average
1	12.7.18	communication	✓			

4. Two positive points about the programme:

Good

5. Suggestions for improvement:

-

Date: 12.7.18

PRINCIPAL,
K. S. R. INSTITUTE FOR
ENGINEERING AND TECHNOLOGY,
K. S. R. KALVI NAGAR,
TIRUCHENGODE-637 215,
NAMAKKAL DI, TAMIL NADU

Signature



Name of the Student: Bharathi Kannan.M.R Branch: EE E

Year / Sem: 19/18

1.Name of the Training : Communication skills

2.Name of the Trainer : MOHUNTHAN RAJ

3.Students rating of Trainers :

S. No.	Date	Subject	Rating (✓)			
			Excellent	Very good	Good	Average
1	12/7/18	Communication skills	✓			

4. Two positive points about the programme: It is useful to our communications.

5. Suggestions for improvement: Nil

Date: 12/7/18

M.R. B
Signature



Name of the Student: M. KAVIYA Branch: EE E

Year / Sem: 19/18

4.Name of the Training : Communication skills

5.Name of the Trainer : MOHUNTHARAS

6.Students rating of Trainers :

S. No.	Date	Subject	Rating (✓)			
			Excellent	Very good	Good	Average
1	12/7/18	communication skills	✓			

4. Two positive points about the programme: Interacts with every one

5. Suggestions for improvement:

Date: 12/7/18

PRINCIPAL,
K. S. R. INSTITUTE FOR
ENGINEERING AND TECHNOLOGY,
K. S. R. KALVI NAGAR,
TIRUCHENGODE-637 215,
NAMAKKAL DI, TAMIL NADU.

[Signature]
Signature

10/11/18
17/11/18
18/11/18
19/11/18
20/11/18
21/11/18
22/11/18
23/11/18
24/11/18
25/11/18
26/11/18
27/11/18
28/11/18
29/11/18
30/11/18
1/12/18
2/12/18
3/12/18
4/12/18
5/12/18
6/12/18
7/12/18
8/12/18
9/12/18
10/12/18
11/12/18
12/12/18
13/12/18
14/12/18
15/12/18
16/12/18
17/12/18
18/12/18
19/12/18
20/12/18
21/12/18
22/12/18
23/12/18
24/12/18
25/12/18
26/12/18
27/12/18
28/12/18
29/12/18
30/12/18

TIRUCHENGODE - 637 215
TRAINING PROGRAMME FEEDBACK FORM



Name of the Student: M. Dhayanidhi Branch: Mechanical Engineering

Year / Sem: III / V

1. Name of the Training: Advanced communication skills

2. Name of the Trainer: C. Mughanthyarajan

3. Students rating of Trainers: 5/5

S. No.	Date	Subject	Rating (✓)			
			Excellent	Very good	Good	Average
1	30-7-18	Ice breaking		✓		

4. Two positive points about the programme:

To improve the skills in communication

5. Suggestions for improvement:

Date: 30/7/18

[Signature]
Signature

K S R INSTITUTE FOR ENGINEERING AND TECHNOLOGY
TIRUCHENGODE - 637 215
TRAINING PROGRAMME FEEDBACK FORM



Name of the Student: K. Chandrasekar Branch: Mechanical Engineering

Year / Sem: III / V

4. Name of the Training: Advance communication skills

5. Name of the Trainer: C. Mughanthyarajan

6. Students rating of Trainers: 4.5/5

S. No.	Date	Subject	Rating (✓)			
			Excellent	Very good	Good	Average
1	30-07-18	Active vs passive listening		✓		

4. Two positive points about the programme:

5. Suggestions for improvement:

Date: 30/7/18

[Signature]
PRINCIPAL,
K. S. R. INSTITUTE FOR
ENGINEERING AND TECHNOLOGY,
K. S. R. KALVI NAGAR,
TIRUCHENGODE-637 215,
NAMAKKAL DI, TAMIL NADU.
[Signature]
Signature



Name of the Student: LOGESH.S

Branch: MECHANICAL Engineering

Year / Sem: III / IV

1. Name of the Training: Placement training

2. Name of the Trainer: Muguntharajan

3. Students rating of Trainers :

S. No.	Date	Subject	Rating (✓)			
			Excellent	Very good	Good	Average
1	30.7.18	Advanced communication skills	✓			

4. Two positive points about the programme:

- * communicate with others
- * Breaks fear.

5. Suggestions for improvement:

Date: 30/7/18

S. L.
Signature



Name of the Student: KAVIN KUMAR.R

Branch: MECH

Year / Sem: VI / V

4. Name of the Training: placement training.

5. Name of the Trainer: Muguntharajan

6. Students rating of Trainers :

S. No.	Date	Subject	Rating (✓)			
			Excellent	Very good	Good	Average
1	30/7/18	Advanced communication skills	✓			

4. Two positive points about the programme:

- very useful for our communication

5. Suggestions for improvement:

Date: 30/7/18

PRINCIPAL,
K. S. R. INSTITUTE FOR
ENGINEERING AND TECHNOLOGY
K. S. R. KALVI NAGAR,
TIRUCHENGODE-637 215,
NAMAKKAL Dt, TAMIL NADU.

R. Kalyan
Signature



Name of the Student: Manoj R

Branch: Mechanical

Year / Sem: III / V

1. Name of the Training: PLACEMENT TRAINING (Advanced Communication skills)

2. Name of the Trainer: M. Kuthasigan

3. Students rating of Trainers: 4/5

S. No.	Date	Subject	Rating (✓)			
			Excellent	Very good	Good	Average
1	06/08/18	ENGLISH	✓			

4. Two positive points about the programme: * It is very useful to improve our skills. * And useful to have to act with other peoples.

5. Suggestions for improvement: To improve General knowledge and Trainers will having a good qualification.

Date: 06/08/18

Signature M. Manoj



Name of the Student: M. Vinodhmani

Branch: mechanical

Year / Sem: III / V

4. Name of the Training: PLACEMENT TRAINING (Advanced communication skills)

5. Name of the Trainer: M. Kuthasigan

6. Students rating of Trainers: 5/5

S. No.	Date	Subject	Rating (✓)			
			Excellent	Very good	Good	Average
1	06/8/18	English	✓			

4. Two positive points about the programme: >> very useful for developing our skills.
>> how to interact with other people.

5. Suggestions for improvement:

Nothing

Date:

06/8/18

PRINCIPAL,
K. S. R. INSTITUTE FOR
ENGINEERING AND TECHNOLOGY,
K. S. R. KALVI NAGAR,
TIRUCHENGODE-637 215,
NAMAKKAL DI, TAMIL NADU.

Signature

[Signature]



Name of the Student: R.H. Senthinathan Branch: B.E. Mechanical
Year / Sem: III / V

1. Name of the Training: English

2. Name of the Trainer: C. Muguntharajan

3. Students rating of Trainers :

S. No.	Date	Subject	Rating (✓)			
			Excellent	Very good	Good	Average
1	06.08.18	English	✓			

4. Two positive points about the programme: i) good communication.
ii) listening is good is students

5. Suggestions for improvement:

Date: 06.08.18

S. Ramy
Signature



Name of the Student: S. Ragavendhar Branch: B.E. Mechanical
Year / Sem: III / V

4. Name of the Training : English

5. Name of the Trainer : C. Muguntharajan

6. Students rating of Trainers :

S. No.	Date	Subject	Rating (✓)			
			Excellent	Very good	Good	Average
1	06-08-18	English	✓			

4. Two positive points about the programme: i) Excellent approach
ii) Useful for our personal skill development

5. Suggestions for improvement:

Date: 06-08-18

S. Ramy
Signature
PRINCIPAL,
K. S. R. INSTITUTE FOR
ENGINEERING AND TECHNOLOGY,
K. S. R. KALVI NAGAR,
TIRUCHENGODE-637 215,
NAMAKKAL DI, TAMIL NADU.



Name of the Student: S. nareesh kumar Branch: ECE

Year / Sem: 3rd / IV

1. Name of the Training: Advanced Communication Skill

2. Name of the Trainer: Mugundharajan Sir

3. Students rating of Trainers: 10

S. No.	Date	Subject	Rating (✓)			
			Excellent	Very good	Good	Average
1	14.8.18	ACS	✓			

4. Two positive points about the programme: very interesting good activities

5. Suggestions for improvement:

NO

S. nareesh
Signature

Date: 14.8.18



Name of the Student: G. Srinathi Branch: ECE

Year / Sem: 3rd / IV

4. Name of the Training: Advanced Communication Skill

5. Name of the Trainer: Mugundharajan Sir

6. Students rating of Trainers: 10

S. No.	Date	Subject	Rating (✓)			
			Excellent	Very good	Good	Average
1	14.8.18	ACS		✓		

4. Two positive points about the programme: easy to understand

5. Suggestions for improvement: No Improvement

Date: 14.8.18

PRINCIPAL,
K. S. R. INSTITUTE FOR
ENGINEERING AND TECHNOLOGY,
K. S. R. KALVI NAGAR,
TIRUCHENGODE-637 215,
NAMAKKAL DI, TAMIL NADU.
G. Srinathi
Signature

Name of the Student: J. Thampthuan Branch: MECHANICALYear / Sem: III - IV1. Name of the Training: Advanced soft skill2. Name of the Trainer: Muguntharajan

3. Students rating of Trainers :

S. No.	Date	Subject	Rating (✓)			
			Excellent	Very good	Good	Average
1	7/02/2018	English	✓			

4. Two positive points about the programme: motivation in student5. Suggestions for improvement: It is very useful.Date: 7/8/18 - FN

Signature
Name of the Student: B. SANTHOSHUMAR Branch: MECHANICALYear / Sem: III / IV4. Name of the Training: Advanced soft skill5. Name of the Trainer: Muguntharajan

6. Students rating of Trainers :

S. No.	Date	Subject	Rating (✓)			
			Excellent	Very good	Good	Average
1	7/08/2018	English	✓			

4. Two positive points about the programme: Motivating & interesting5. Suggestions for improvement: No suggestionsDate: 7/8/18 - AN

PRINCIPAL,
K. S. R. INSTITUTE FOR
ENGINEERING AND TECHNOLOGY,
K. S. R. KALVI NAGAR,
TIRUCHENGODE-637 215,
NAMAKKAL DL, TAMIL NADU.

Signature

Name of the Student: B. VigneshBranch: MECHANICALYear / Sem: III / B1. Name of the Training: Advanced soft skills2. Name of the Trainer: Muthan

3. Students rating of Trainers :

S. No.	Date	Subject	Rating (✓)			
			Excellent	Very good	Good	Average
1	7/8/2018	English	✓			

4. Two positive points about the programme: 1. Motivation for student
2. Very interesting

5. Suggestions for improvement:

Date: 7/8/18 - FN

Signature

K S R INSTITUTE FOR ENGINEERING AND TECHNOLOGY
TIRUCHENGODE - 637 215

TRAINING PROGRAMME FEEDBACK FORM

Name of the Student: S. K. PRANEESHBranch: MECHANICALYear / Sem: III / B4. Name of the Training: Advanced soft skills5. Name of the Trainer: MUTHAN

6. Students rating of Trainers :

S. No.	Date	Subject	Rating (✓)			
			Excellent	Very good	Good	Average
1	7/8/2018	English	✓			

4. Two positive points about the programme: 1. Motivation for student
2. Very interesting

5. Suggestions for improvement:

Date: 7/8/18 - AN

Signature

PRINCIPAL
K. S. R. INSTITUTE FOR
ENGINEERING AND TECHNOLOGY
K. S. R. KALVI NAGAR
TIRUCHENGODE-637 215
MANNARKKAL BH, TAMIL NADU.



Name of the Student: R. Anandharajaram Branch: ECE - A

Year / Sem: IIIrd - year 5th Sem

1. Name of the Training: Advanced Communication Skill

2. Name of the Trainer: C. Mugartharajan

3. Students rating of Trainers: 9

S. No.	Date	Subject	Rating (✓)			
			Excellent	Very good	Good	Average
1	24/07/2018	Advanced communication skill	✓			

4. Two positive points about the programme: is useful for the Place Jobs.
It is motivating the student

5. Suggestions for improvement:

Date: 24/07/2018

[Signature]
Signature



Name of the Student: Kajapathy - V Branch: ECE

Year / Sem: IIIrd/V

4. Name of the Training: Advanced communication skills

5. Name of the Trainer: C. Mugartharajan

6. Students rating of Trainers: 10

S. No.	Date	Subject	Rating (✓)			
			Excellent	Very good	Good	Average
1	24/7/18	Advanced communication skills	✓			

4. Two positive points about the programme: It is useful to improve our food quality

5. Suggestions for improvement:

Date: 24/7/18

[Signature]
PRINCIPAL,
K. S. R. INSTITUTE FOR
ENGINEERING AND TECHNOLOGY,
K. S. R. KALVINAGAN
TIRUCHENGODE - 637 215,
NAMAKKAL Dt. TAMIL NADU.

[Signature]
Signature

TRAINING PROGRAMME FEEDBACK FORM

Name of the Student: S. Yogesh Branch: ECF-B' 2nd year

Year / Sem: 3rd / V

1. Name of the Training: Advanced Communication skill

2. Name of the Trainer: Mugundharajan sir

3. Students rating of Trainers: 10

S. No.	Date	Subject	Rating (✓)			
			Excellent	Very good	Good	Average
1	13.8.18	ACS	✓			

4. Two positive points about the programme: easy to understand
Sir give full freedom

5. Suggestions for improvement:

nothing...

S. Yogesh

Date: 13.8.18

Signature

TRAINING PROGRAMME FEEDBACK FORM

Name of the Student: Nivetha S Branch: ECF

Year / Sem: 3rd / V

4. Name of the Training: Advanced Communication Skills

5. Name of the Trainer: Dr. Mugundharajan Sir

6. Students rating of Trainers: 10

S. No.	Date	Subject	Rating (✓)			
			Excellent	Very good	Good	Average
1	13.8.18	ACS	✓			

4. Two positive points about the programme:

class was very interesting to understand.
we do more activities.

5. Suggestions for improvement:

Nothing.

Nivetha

Signature

Date: 13.8.18

PRINCIPAL,
K. S. R. INSTITUTE FOR
ENGINEERING AND TECHNOLOGY,
K. S. R. KALVI NAGAR,
TIRUCHENGODE-637 215,
NAMAKKAL DI, TAMIL NADU.

9, 10, 11, 12, 13

TRAINING AND PLACEMENT CELL



Training Schedule [2018 - 2019] Odd Semester

Ref: KSRIET/T&P/CIR/2018-19

Date: 16.07.2018

This is to inform that all the HoD's, Faculty and Mechanical Department Training and Placement coordinator that the 5 Days External Training Programme for IV Year Mechanical Students for the academic year 2018 - 2019 (Odd Sem) by Talent 2 Success Learning Pvt Ltd has been scheduled. All the registered students should attend the Training Programme without fail. If any student skips this Training Programme without proper permission from the respective HoDs, he / she will not be permitted for any further Training Programme and campus recruitment process. Proper Dress Code is mandatory.

S.No	Date(s)	Department(Strength) & Venue
1	23.07.2018	
	24.07.2018	MECH A (52)- MIC 205
	25.07.2018	MECH B (44) - MIC 206
	26.07.2018	
	27.07.2018	MECH C (43) - MIC 208

[Signature]
T&P OFFICER

[Signature]
T&P COORDINATOR

[Signature]
PRINCIPAL

Copy to:

- 1. All HoDs
- 2. Notice Board

Session Timings:

Forenoon Session: 09.00 AM to 12.30 PM

Break: 10.45 AM to 11.00 AM

Afternoon Session: 01.15 PM to 04.15 PM

Lunch: 12.30 PM to 01.15 PM

Evening Assessment & Discussion: 05:00PM to 07:00 PM

PRINCIPAL
K. S. R. INSTITUTE FOR
ENGINEERING AND TECHNOLOGY,
K. S. R. KALVI NAGAR,
TIRUCHENGODE-637 215,
KANNANKAL DI, TAMIL NADU.

K S R INSTITUTE FOR ENGINEERING AND TECHNOLOGY, Tiruchengode

Training and Placement Cell

Quantitative, Reasoning & Verbal Training Programme by Talent 2 Success

BATCH : 2015 - 2019

Sem: Odd

MECH-A

Academic Year: 2018 - 2019

Date of Training Programme					23.07.18			24.07.18			25.07.18			26.07.18			27.07.18		
S.No	Reg No	Name	MOBILE NO.	BATCH	FN	AN	AN	FN	AN	AN	FN	AN	AN	FN	AN	AN	FN	AN	AN
1	731615114001	ADHISHANKARAN D	9445640161	1	/	/	/	/	/	/	/	/	/	/	/	/	/	/	/
2	731615114002	AJITH K S	9003740639	3	/	/	/	/	/	/	/	/	/	/	/	/	/	/	/
3	731615114003	AJITH V	9600408946	3	/	/	/	/	/	/	/	/	/	/	/	/	/	/	/
4	731615114004	AJITHKUMAR S	8124714246	2	L	L	L	/	/	/	/	/	/	/	/	/	/	/	/
5	731615114005	AJITH KUMAR S	9585944522	3	/	/	/	/	/	/	/	/	/	/	/	/	/	/	/
6	731615114006	AKILAN M	9894994470	3	/	/	/	/	/	/	/	/	/	/	/	/	/	/	/
7	731615114007	ALEXANDER M	8675296403	1	/	/	/	/	/	/	/	/	/	/	/	/	/	/	/
8	731615114009	ARAVINTHAN P V	9994124413	1	/	/	/	/	/	/	/	/	/	/	/	/	/	/	/
	731615114010	ARAVINTHASAMY B	7871965175	1	/	/	/	/	/	/	/	/	/	/	/	/	/	/	/
10	731615114012	ASHWIN L	7708440282	3	/	/	/	/	/	/	/	/	/	/	/	/	/	/	/
11	731615114014	BALAJI M	9443476218	2	/	/	/	/	/	/	/	/	/	/	/	/	/	/	/
12	731615114015	BALAJI M	9524406772	3	/	/	/	/	/	/	/	/	/	/	/	/	/	/	/
13	731615114016	BALAJI RAM G	9688418258	3	/	/	/	/	/	/	/	/	/	/	/	/	/	/	/
14	731615114017	BALAKRISHNAN C	9659707623	3	/	/	/	/	/	/	/	/	/	/	/	/	/	/	/
15	731615114018	BALAKUMAR A	7092033570	2	/	/	/	/	/	/	/	/	/	/	/	/	/	/	/
16	731615114019	BENAZIR U	9486915175	3	/	/	/	/	/	/	/	/	/	/	/	/	/	/	/
17	731615114020	BHARATH P	9629882943	3	/	/	/	/	/	/	/	/	/	/	/	/	/	/	/
18	731615114021	BHARATHI K N	8220511255	1	/	/	/	/	/	/	/	/	/	/	/	/	/	/	/
19	731615114022	BHARATH KUMAR S	8098884501	3	/	/	/	/	/	/	/	/	/	/	/	/	/	/	/
20	731615114023	BHUVANESHWARAN S	7373193228	2	/	/	/	/	/	/	/	/	/	/	/	/	/	/	/
21	731615114024	BOOPATHIRAJA S	8903794783	1	/	/	/	/	/	/	/	/	/	/	/	/	/	/	/
22	731615114025	CELLAKAMALALAKSHMI	9597251074	3	/	/	/	L	L	L	L	L	L	L	L	L	L	L	L
23	731615114027	DEENADHAYALAN P	8870273539	3	/	/	/	/	/	/	/	/	/	/	/	/	/	/	/
24	731615114028	DEVA S	9095840741	3	/	/	/	/	/	/	/	/	/	/	/	/	/	/	/
25	731615114029	DHANASEKAR R	8754914312	2	/	/	/	/	/	/	/	/	/	/	/	/	/	/	/
26	731615114031	DHARANISHANKAR P	8680911807	3	/	/	/	/	/	/	/	/	/	/	/	/	/	/	/
27	731615114032	DHINESH S	9715376972	2	/	/	/	/	/	/	/	/	/	/	/	/	/	/	/
28	731615114033	DHINESHRAJ L	9965497882	1	/	/	/	/	/	/	/	/	/	/	/	/	/	/	/
29	731615114034	DINESH J	9659454552	1	/	/	/	/	/	/	/	/	/	/	/	/	/	/	/
30	731615114037	DINESHKUMAR B	9487381977	1	/	/	/	/	/	/	/	/	/	/	/	/	/	/	/
31	731615114038	DINESHKUMAR T	9445249206	2	/	/	/	/	/	/	/	/	/	/	/	/	/	/	/
32	731615114039	DUDIARASU S	8675828155	1	/	/	/	/	/	/	/	/	/	/	/	/	/	/	/
33	731615114042	GABY SACHIN S	9566303560	1	/	/	/	/	/	/	/	/	/	/	/	/	/	/	/
34	731615114043	GIRI K	8122421699	3	/	/	/	/	/	/	/	/	/	/	/	/	/	/	/
35	731615114044	GIRIDHARAN B	8124508266	1	/	/	/	/	/	/	/	/	/	/	/	/	/	/	/
36	731615114045	GNANA PRAKASH A S	9514075912	3	/	/	/	/	/	/	/	/	/	/	/	/	/	/	/
37	731615114046	GOBINATH R	8124486884	2	/	/	/	/	/	/	/	/	/	/	/	/	/	/	/
38	731615114047	GOKUL P	9942915192	3	/	/	/	/	/	/	/	/	/	/	/	/	/	/	/

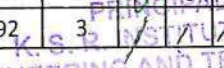
K. S. R. INSTITUTE FOR ENGINEERING AND TECHNOLOGY,
K. S. R. KALVI NAGAR,
TIRUCHENGODE-637 215,
NAMAKKAL DI, TAMIL NADU.

39	731615114048	GOKUL MAYURA PRIYAN	7598001037	3	/	/	/	/	/	/	/	/	/	/	/	/	/	/	/
40	731615114049	GOKULRAJ V	8760048576	3	/	/	/	/	/	/	/	/	/	/	/	/	/	/	/
41	731615114050	GOPIKA R	9942588514	3	/	L	L	/	/	/	/	/	/	/	/	/	/	/	/
42	731615114051	GOWTHAM K	9715792698	1	/	/	/	/	/	/	/	/	/	/	/	/	/	/	/
43	731615114052	HARIPRASATH S	9597361895	3	/	/	/	/	/	/	/	/	/	/	/	/	/	/	/
44	731615114053	HARIRAJ K	8189992337	2	/	/	/	/	/	/	/	/	/	/	/	/	/	/	/
45	731615114054	HRITHWIK RAJEEV	9947639099	1	/	/	/	/	/	/	/	/	/	/	/	/	/	/	/
46	731615114055	JACKSON P V	9025843207	1	/	/	/	/	/	/	/	/	/	/	/	/	/	/	/
47	731615114056	JAGADEESH S	7373604049	3	/	/	/	/	/	/	/	/	/	/	/	/	/	/	/
48	731615114057	JAGADEESHBABU K	7708609462	1	/	/	/	/	/	/	/	/	/	/	/	/	/	/	/
49	731615114058	JAGADESHWARAN S	9531956559	1	/	/	/	/	/	/	/	/	/	/	/	/	/	/	/
50	731615114098	NISHANTHI B	9688856943	1	/	/	/	/	/	/	/	/	/	/	/	/	/	/	/
51	731615114301	AJITH M	9626232064	1	/	/	/	/	/	/	/	/	/	/	/	/	/	/	/
52	731615114302	ARUN AKASH S	9487559806	1	/	/	/	L	L	/	/	/	/	/	/	/	/	/	/
PRESENT								51	50	50	50	50	51	51	51	51	51	51	51
ABSENT								-	-	-	-	-	-	-	-	-	-	-	-
PERMISSION								1	2	2	2	2	1	1	1	1	1	1	1
OD																			
NI																			

 PRINCIPAL,
 K. S. R. INSTITUTE FOR
 ENGINEERING AND TECHNOLOGY,
 K. S. R. KALVI NAGAR,
 TIRUCHENGODE-637 215,
 NAMAKKAL Dt, TAMIL NADU.

K S R INSTITUTE FOR ENGINEERING AND TECHNOLOGY, Tiruchengode

Training and Placement Cell

Quantitative, Reasoning & Verbal Training Programme by Talent 2 Success

BATCH : 2015 - 2019

Sem: Odd

MECH-B

Academic Year: 2018 - 2019

Date of Training Programme				23.07.18			24.07.18			25.07.18			26.07.18			27.07.18			
S. No	Reg No	Name	MOBILE NO	BATCH	FN	AN	AN	FN	AN	AN	FN	AN	AN	FN	AN	AN	FN	AN	AN
1	731615114062	KARTHICK R	9092177126	2	/	/	/	/	/	/	/	/	/	/	/	/	/	/	/
2	731615114063	KARTHIKEYAN A	9597272098	2	L	/	/	/	/	/	/	/	/	/	/	/	/	/	/
3	731615114065	KAVIN KUMAR R	9865154730	2	/	/	/	/	/	/	/	/	/	/	/	/	/	/	/
4	731615114066	KAVIPRIYAN S	7305133795	1	/	/	/	/	/	/	/	/	/	/	/	/	/	/	/
5	731615114067	KESAVARAJ M	7871221342	1	/	/	/	/	/	/	/	/	/	/	/	/	/	/	/
6	731615114068	KISHORE M	9600242805	1	/	/	/	/	/	/	/	/	/	/	/	/	/	/	/
7	731615114069	KISHORE KUMAR M	8883647827	2	/	/	/	/	/	/	/	/	/	/	/	/	/	/	/
8	731615114070	KUMAR P	8508078527	1	/	/	/	/	/	/	/	/	/	L	L	L	/	/	/
9	731615114071	LINGESWAR M	9976757283	2	/	/	/	L	L	L	/	/	/	/	/	/	/	/	/
	731615114072	LOGANATHAN K	8122931944	1	/	/	/	/	/	/	/	/	/	/	/	/	/	/	/
11	731615114073	MADHAN KUMAR M	8056454220	1	/	/	/	/	/	/	/	/	/	/	/	/	/	/	/
12	731615114074	MADHUSUDHAN R	9655925099	2	/	/	/	/	/	/	/	/	/	/	/	/	/	/	/
13	731615114075	MANIKANDABOOPATHI B	9600883116	1	/	/	/	/	/	/	/	/	/	/	/	/	/	/	/
14	731615114076	MANIKANDAN G	8526909804	2	/	/	/	/	/	/	/	/	/	/	/	/	/	/	/
15	731615114077	MANIKANDAN P	8344713313	1	/	/	/	/	/	/	/	/	/	/	/	/	/	/	/
16	731615114080	MANOJKUMAR P R	9940796708	1	/	/	/	/	/	/	/	/	/	/	/	/	/	/	/
17	731615114082	MOHAMMED EHIYA S	7092970943	2	/	/	/	/	/	/	/	/	/	/	/	/	/	/	/
18	731615114083	MOHAN KUMAR R	9566892415	1	/	/	/	/	/	/	/	/	/	/	/	/	/	/	/
19	731615114084	MOHAN PRABHU K	9942179178	2	/	/	/	/	/	/	/	/	/	/	/	/	/	/	/
20	731615114087	NANDHAKUMAR S	9095164594	1	/	/	/	/	/	/	/	/	/	/	/	/	/	/	/
21	731615114088	NANDHAKUMAR S	8489359047	1	/	/	/	/	/	/	/	/	/	/	/	/	/	/	/
22	731615114089	NARENDRHIRAN M	7094909332	2	/	/	/	/	/	/	/	/	/	/	/	/	/	/	/
23	731615114090	NAVANEETHAN R	9994963239	3	/	/	/	/	/	/	/	/	/	/	/	/	/	/	/
24	731615114091	NAVEEN M	9500600225	3	/	/	/	/	/	/	/	/	/	/	/	/	/	/	/
25	731615114092	NAVEEN M (20/6/97)	8883114954	3	/	/	/	/	/	/	/	/	/	/	/	/	/	/	/
	731615114093	NAVEEN N	9585600663	2	/	/	/	/	/	/	/	/	/	/	/	/	/	/	/
27	731615114094	NAVEEN KUMAR B	9715302568	1	/	/	/	/	/	/	/	/	/	/	/	/	/	/	/
28	731615114095	NAVEEN KUMAR N	9790636198	3	/	/	/	/	/	/	/	/	/	/	/	/	/	/	/
29	731615114096	NAVEEN KUMAR N	8870900743	3	/	/	/	/	/	/	/	/	/	/	/	/	/	/	/
30	731615114097	NISHANTH E	8883234808	2	/	/	/	/	/	/	/	/	/	/	/	/	/	/	/
31	731615114100	OM ADHAVAN B	8056866294	2	/	/	/	/	/	/	/	/	/	/	/	/	/	/	/
32	731615114102	PRAKASH R	9524005259	3	/	/	/	/	/	/	/	/	/	/	/	/	/	/	/
33	731615114105	PRINSHITH P	8015232441	1	/	/	/	/	/	/	/	/	/	/	/	/	/	/	/
34	731615114106	PRITAM	8870676946	2	/	/	/	/	/	/	/	/	/	/	/	/	/	/	/
35	731615114108	PUVIYARASAN N	9715528986	2	/	/	/	/	/	/	/	/	/	/	/	/	/	/	/
36	731615114109	RAGU S	7402402290	2	/	/	/	/	/	/	/	/	/	/	/	/	/	/	/
37	731615114110	RAJAMANI M	9047512307	1	/	/	/	/	/	/	/	/	/	/	/	/	/	/	/
38	731615114111	RAMANA SARATHI A T	8754339108	2	/	/	/	/	/	/	/	/	/	/	/	/	/	/	/
39	731615114112	RAMESH M	9788010147	2	/	/	/	/	/	/	/	/	/	/	/	/	/	/	/
40	731615114113	RAM KUMAR M	8428851924	2	/	/	/	/	/	/	/	/	/	/	/	/	/	/	/
41	731615114115	ROBERT SAM DANIEL	9952217354	1	/	/	/	/	/	/	/	/	/	/	/	/	/	/	/

PRINCIPAL,
K. S. R. INSTITUTE FOR
ENGINEERING AND TECHNOLOGY,
K. S. R. KALVI NAGAR,
TIRUCHENGODE-637 215,
NAMAIKKAL Dt, TAMIL NADU.

42	731615114308	V.GOWTHAM	8124876902	2	/	/	/	/	/	/	/	/	/	/	/	/	/	/
43	731615114309	KARTHIK .G	9865379479	3	/	/	/	/	/	/	/	/	/	/	/	/	/	/
44	731615114312	K.MAHESHWARAN	9578093813	3	/	/	/	/	/	/	/	/	/	/	/	/	/	/
PRESENT					43	44	44	43	43	43	44	44	44	43	43	43	44	44
ABSENT					-	-	-	-	-	-	-	-	-	-	-	-	-	-
PERMISSION					1	-	-	1	1	1	-	-	-	1	1	1	-	-
OD																		
NI																		

PRINCIPAL.
 K. S. R. INSTITUTE FOR
 ENGINEERING AND TECHNOLOGY,
 K. S. R. KALVI NAGAR,
 TIRUCHENGODE-637 215,
 NAMAKKAL DI, TAMIL NADU.

K S R INSTITUTE FOR ENGINEERING AND TECHNOLOGY, Tiruchengode

Training and Placement Cell

Quqntitative, Reasoning & Verbal Training Programme by Talent 2 Success

ATCH : 2015 - 2019

Sem: Odd

MECH-C

Academic Year: 2018 - 2019

Date of Trainng Programme					23.07.18			24.07.18			25.07.18			26.07.18			27.07.18		
S. No	Reg No	Name	Branch	BATCH	FN	AN	AN	FN	AN	AN	FN	AN	AN	FN	AN	AN	FN	AN	AN
1	731615114117	SAI HARISH V	9486524824	1	/	/	/	/	/	/	/	/	/	/	/	/	/	/	/
2	731615114120	SANTHOSH K	9488892297	1	/	/	/	/	/	/	/	/	/	/	/	/	/	/	/
3	731615114122	SANTHOSH KUMAR M	8489198840	3	/	/	/	/	/	/	/	/	/	/	/	/	/	/	/
4	731615114123	SANTHOSH KUMAR R	8428497261	1	/	/	/	/	/	/	/	/	/	/	/	/	/	/	/
5	731615114124	SARAVANAN M	8760634490	1	/	/	/	/	/	/	/	/	/	/	/	/	/	/	/
6	731615114128	SATHISH KUMAR S	7639453378	2	/	/	/	/	/	/	/	/	/	/	/	/	/	/	/
7	731615114129	SATHISHKUMAR T	7806868878	2	/	/	/	/	/	/	/	/	/	/	/	/	/	/	/
8	731615114131	SELVAKUMAR R	9842043104	2	/	/	/	/	/	/	/	/	/	/	/	/	/	/	/
9	731615114133	SHANKAR K	8870833227	2	/	/	/	/	/	/	/	/	/	/	/	/	/	/	/
10	731615114135	SHREERAM M R	9566357051	1	/	/	/	/	/	/	/	/	/	/	/	/	/	/	/
11	731615114136	SHUKEL AHAMED M	8883532024	2	L	L	L	L	L	L	L	L	L	L	L	L	L	L	L
12	731615114137	SHYAM SUNDAR S	9003621892	3	/	/	/	/	/	/	/	/	/	/	/	/	/	/	/
13	731615114139	SRIDHAR L	7502308497	3	/	/	/	/	/	/	/	/	/	/	/	/	/	/	/
14	731615114140	SUBHASH S	9791677416	2	/	/	/	/	/	/	/	/	/	/	/	/	/	/	/
15	731615114141	SUDHAKAR R M	9600575621	2	/	/	/	/	/	/	/	/	/	/	/	/	/	/	/
16	731615114142	SUDHARSEN M	9659173450	2	/	/	/	/	/	/	/	/	/	/	/	/	/	/	/
17	731615114146	SURYA S C	8344941899	1	/	/	/	/	/	/	/	/	/	/	/	/	/	/	/
18	731615114147	SYLESH P	9629740478	1	L	L	L	L	L	L	/	/	/	/	/	/	/	/	/
19	731615114148	TAMILVANAN M	8754685369	3	/	/	/	/	/	/	/	/	/	/	/	/	/	/	/
20	731615114149	THAGAPPILLAI G	8681013274	3	/	/	/	/	/	/	/	/	/	/	/	/	/	/	/
21	731615114151	THAMIL SELVAM S	7305777101	3	/	/	/	/	/	/	/	/	/	/	/	/	/	/	/
22	731615114152	UMANATH G	9865269042	3	/	/	/	/	/	/	/	/	/	/	/	/	/	/	/
23	731615114153	VASANTHAKUMAR B	8148676323	1	/	/	/	/	/	/	/	/	/	/	/	/	/	/	/
24	731615114155	VENGAINAYAGAN K	9095941728	3	/	/	/	/	/	/	/	/	/	/	/	/	/	/	/
25	731615114156	VENKADESAN I	7373282822	3	/	/	/	/	/	/	/	/	/	/	/	/	/	/	/
26	731615114157	VENUGOPAL P	8148703351	2	/	/	/	/	/	/	/	/	/	/	/	/	/	/	/
27	731615114158	VIGNESH M	8675992665	1	/	/	/	/	/	/	/	/	/	/	/	/	/	/	/
28	731615114160	VIGNESH S	9750424951	2	/	/	/	/	/	/	/	/	/	/	/	/	/	/	/
29	731615114161	VIJAY M	8110912384	1	L	L	L	L	L	L	L	L	L	L	L	L	L	L	L
30	731615114162	VIJAY P	9159040517	2	/	/	/	/	/	/	/	/	/	/	/	/	/	/	/
31	731615114163	VIMALRAJ R	7867071067	2	/	/	/	/	/	/	/	/	/	/	/	/	/	/	/
32	731615114164	VINOTH KUMAR P	9787132387	2	/	/	/	/	/	/	/	/	/	/	/	/	/	/	/
33	731615114166	YOGESH K	7502574814	2	/	/	/	/	/	/	/	/	/	/	/	/	/	/	/
34	731615114316	PRAVINTH .K	9865034430	2	/	/	/	/	/	/	/	/	/	/	/	/	/	/	/
35	731615114317	RADHAKRISHNAN M	8012420476	3	L	L	L	L	L	L	L	L	L	L	L	L	L	L	L
36	731615114318	RANJITHKUMAR .M	8122829618	2	/	/	/	/	/	/	/	/	/	/	/	/	/	/	/
37	731615114319	REVENTHKUMAR S	9976932749	3	/	/	/	/	/	/	/	/	/	/	/	/	/	/	/

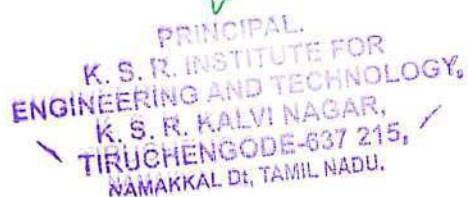
 PRINCIPAL,
 K. S. R. INSTITUTE FOR
 ENGINEERING AND TECHNOLOGY,
 K. S. R. KALVI NAGAR,
 TIRUCHENGODE-637 215,
 NAMAKKAL Dt, TAMIL NADU.

38	731615114320	SARANKUMAR R	9944219551	3	/	/	/	/	/	/	/	/	/	/	/	/	/	/	/
39	731615114321	SENGOTAIYAN R	9087060353	3	/	/	/	/	/	/	/	/	/	/	/	/	/	/	/
40	731615114322	SUNILRAJ C	7092694673	2	/	/	/	/	/	/	/	/	/	/	/	/	/	/	/
41	731615114323	THIRU MOORTHY B	8973797789	3	/	/	/	/	/	/	/	/	/	/	/	/	/	/	/
42	731615114701	NAVANEETHA KRISHNAN M	8675391488	2	/	/	/	/	/	/	/	/	/	/	/	/	/	/	/
PRESENT					38	38	38	38	38	38	39	39	39	39	39	39	39	39	39
ABSENT					-	-	-	-	-	-	-	-	-	-	-	-	-	-	-
PERMISSION					4	4	4	4	4	4	3	3	3	3	3	3	3	3	3
OD					1	1	1	1	1	1	1	1	1	1	1	1	1	1	1
743	731615114313	NAVEENA	8012218063	3	OD	OD	OD	OD	OD	OD	OD	OD	OD	OD	OD	OD	OD	OD	OD

 PRINCIPAL,
 K. S. R. INSTITUTE FOR
 ENGINEERING AND TECHNOLOGY,
 K. S. R. KALVI NAGAR,
 TIRUCHENGODE-637 215,
 NAMAKKAL DISTRICT, TAMIL NADU.

MECH A, B & C Aptitude, Reasoning & Verbal Training Programme by
Talent 2 Success Learning

BATCH: 2015 - 2019

ACADEMIC YEAR: 2018 - 2019 (ODD)

DATE: 23.07.2018

Fore Noon session

S.NO	Branch	Strength	Present	Absent	Permission
1	Batch 1	47	45	0	2
2	Batch 2	47	44	0	3
3	Batch 3	45	44	0	1
Total		139	133	0	6

After Noon session

S.NO	BRANCH	Strength	Present	Absent	Leave
1	Batch 1	47	45	0	2
2	Batch 2	47	45	0	2
3	Batch 3	45	43	0	2
Total		139	133	0	6

V. Kalarthi
T & P OFFICER

T&P CO ORDINATOR

PRINCIPAL

PRINCIPAL.
K. S. R. INSTITUTE FOR
ENGINEERING AND TECHNOLOGY,
K. S. R. KALVI NAGAR,
TIRUCHENGODE-637 215,
NAMAKKAL DI, TAMIL NADU.

TRAINING & PLACEMENT CELL



**MECH A, B & C Aptitude, Reasoning & Verbal Training Programme by
Talent 2 Success Learning**

BATCH: 2015 - 2019

ACADEMIC YEAR: 2018 - 2019 (ODD)

DATE: 24.07.2018

Fore Noon session

S.NO	Branch	Strength	Present	Absent	Permission
1	Batch 1	47	44	0	3
2	Batch 2	47	45	0	2
3	Batch 3	45	43	0	2
Total		139	132	0	7

After Noon session

S.NO	BRANCH	Strength	Present	Absent	Leave
1	Batch 1	47	44	0	3
2	Batch 2	47	45	0	2
3	Batch 3	45	43	0	2
Total		139	132	0	7

K. Kalvi
T & P OFFICER

[Signature]
T&P CO ORDINATOR

[Signature]
PRINCIPAL

[Green Stamp]
PRINCIPAL,
K. S. R. INSTITUTE FOR
ENGINEERING AND TECHNOLOGY,
K. S. R. KALVI NAGAR,
TIRUCHENGODE-637 215,
NAMAKKAL DI, TAMIL NADU.



Name of the Student: R. Dhana Sekar

Branch: BE - NECH

Year / Sem: FINAL YEAR / VI

1. Name of the Training: Verbal Aptitude

2. Name of the Trainer: N. SARAVANAN

3. Students rating of Trainers :

S. No.	Date	Subject	Rating (✓)			
			Excellent	Very good	Good	Average
1	25/07/18	Verbal Aptitude			✓	

4. Two positive points about the programme:

~~has~~ Learned More knowledge
Good in verbal Aptitude

5. Suggestions for improvement:

Need More ideas about verbal
Games

Date: 25/07/18

Signature Ran
R. Dhana Sekar

PRINCIPAL,
K. S. R. INSTITUTE FOR
ENGINEERING AND TECHNOLOGY,
K. S. R. KALVI NAGAR,
TIRUCHENGODE-637 215,
NAMAKKAL Dt. TAMIL NADU.



Name of the Student: R. Anandharajan Branch: ECE - A

Year / Sem: IIIrd - year 5th Sem

1. Name of the Training: Advanced Communication Skill

2. Name of the Trainer: C. Mugartharajan

3. Students rating of Trainers: 9

S. No.	Date	Subject	Rating (✓)			
			Excellent	Very good	Good	Average
1	24/07/2018	Advanced communication skill	✓			

4. Two positive points about the programme: is useful for the Place Jobs.
ii) He is motivating the student

5. Suggestions for improvement: -

Date: 24/07/2018

C. Mugartharajan
Signature



Name of the Student: Kajapathy - V Branch: ECE

Year / Sem: IIIrd/V

4. Name of the Training: Advanced communication skills

5. Name of the Trainer: C. Mugartharajan

6. Students rating of Trainers: 10

S. No.	Date	Subject	Rating (✓)			
			Excellent	Very good	Good	Average
1	24/7/18	Advanced communication skills	✓			

4. Two positive points about the programme: It is useful to improve our food quality

5. Suggestions for improvement: -

Date: 24/7/18

PRINCIPAL,
K. S. R. INSTITUTE FOR
ENGINEERING AND TECHNOLOGY,
K. S. R. KALVINAGAN
TIRUCHENGODE - 637 215,
NAMAKKAL Dt. TAMIL NADU.

K. S. R. Kalvinagan
Signature

Name of the Student: M. NarendhianBranch: Mech - BYear / Sem: IV / VI1. Name of the Training: odd man out, Profit & loss, Interest calculation, Relation & proportion2. Name of the Trainer: Manojkumar

3. Students rating of Trainers :

S. No.	Date	Subject	Rating (√)			
			Excellent	Very good	Good	Average
1	24.7.18	Profit & loss	✓			

4. Two positive points about the programme:

- Short cuts of interest calculation
- Improving speed and choosing solving method.

5. Suggestions for improvement:

- Nil

Date: 24.7.18

M. Narendhian
Signature

Name of the Student: R. DHANASEKARBranch: MECHANICAL - IV - YEARYear / Sem: IV - VII1. Name of the Training: Profit and loss, ODD MAN OUT, Ratio & Proportion2. Name of the Trainer: Manojkumar

3. Students rating of Trainers :

S. No.	Date	Subject	Rating (√)			
			Excellent	Very good	Good	Average
1	24.7.2018	Aptitude		✓		

4. Two positive points about the programme:

- To calculate the profit and loss is easily
- Short cut to learn

5. Suggestions for improvement:

Date: 24.7.2018

PRINCIPAL,
K. S. R. INSTITUTE FOR
ENGINEERING AND TECHNOLOGY,
K. S. R. KALVI NAGAR,
TIRUCHENGODE-637 215,
NAMAKKAL DI, TAMIL NADU.

R. Dhanasekar
Signature

JAN

TIRUCHENGODE - 637 215
TRAINING PROGRAMME FEEDBACK FORM



205

Name of the Student: P. Manikandan Branch: Mechanical
Year / Sem: IV - 7th

1. Name of the Training: profit & loss, interest calculation.
2. Name of the Trainer: prema
3. Students rating of Trainers:

S. No.	Date	Subject	Rating (✓)			
			Excellent	Very good	Good	Average
1	24/7/18	profit & loss, interest		✓		

4. Two positive points about the programme:
 * Easy to understand for profit & loss concept.
 * Easily explain the formulas
5. Suggestions for improvement:
 ⇒ TO teach the topic with speed

Date:

Signature

K S R INSTITUTE FOR ENGINEERING AND TECHNOLOGY
TIRUCHENGODE - 637 215
TRAINING PROGRAMME FEEDBACK FORM



Name of the Student: Robert Sam Daniel Branch: Mechanical

- Year / Sem: IV / VII
4. Name of the Training: Ratio & proportion, odd man out
5. Name of the Trainer: Sowmiya. V
6. Students rating of Trainers:

S. No.	Date	Subject	Rating (✓)			
			Excellent	Very good	Good	Average
1	24/7/18	Ratio & proportion odd man out				

4. Two positive points about the programme:
 Giving easy tips to solve the problem
 Able to grasp the topic easily.
5. Suggestions for improvement:
 Need to reduce the speed of explanation

Date:

Signature
PRINCIPAL.
K. S. R. INSTITUTE FOR
ENGINEERING AND TECHNOLOGY
K. S. R. KALVI NAGAR
TIRUCHENGODE
NAMAKKAL DISTRICT

Date: 29 / 7 / 18

Signature

K S R INSTITUTE FOR ENGINEERING AND TECHNOLOGY
TIRUCHENGODE - 637 215

TRAINING PROGRAMME FEEDBACK FORM



D

Name of the Student: M. Tamilanathan Branch: P.P (Mechanical)

Year / Sem:

4. Name of the Training : Profit & loss Simple Interest (Talent & Success)

5. Name of the Trainer : Pavithra

6. Students rating of Trainers : 3.5

S. No.	Date	Subject	Rating (✓)			
			Excellent	Very good	Good	Average
1	24/07/18	Profit & Simple Interest		✓		

4. Two positive points about the programme:

Easy learn
shortcut & concept

5. Suggestions for improvement:

Explanation is Average

Date: 24/07/18

Signature
M. Jeyaraj

PRINCIPAL,
K. S. R. INSTITUTE FOR
ENGINEERING AND TECHNOLOGY,
K. S. R. KALVI NAGAR,
TIRUCHENGODE-637 215,
NAMAIGAL DE TAMIL NADU.



Name of the Student: Kirhan Kumar M

Branch: Mechanical B

Year / Sem: 10 / 4th

4. Name of the Training: Aptitude

5. Name of the Trainer: Ranga Kumar A

6. Students rating of Trainers: 5

S. No.	Date	Subject	Rating (✓)			
			Excellent	Very good	Good	Average
1	24/7/18	Aptitude		✓		

4. Two positive points about the programme: problem solving skills (clear)

5. Suggestions for improvement: Nil

Date: 24/7/18

[Signature]
Signature



Name of the Student: Venugopal P

Branch: Mechanical

Year / Sem: IV / VII

4. Name of the Training: Aptitude

5. Name of the Trainer: Murugan Kumar A

6. Students rating of Trainers:

S. No.	Date	Subject	Rating (✓)			
			Excellent	Very good	Good	Average
1	24/07/18			✓		

4. Two positive points about the programme:

To compute profit & loss easily.
To calculate ratio & proportion.

5. Suggestions for improvement:

Date: 24/07/18

PRINCIPAL,
K. S. R. INSTITUTE FOR
ENGINEERING AND TECHNOLOGY,
K. S. R. KALVI NAGAR,
TIRUCHENGODE-637 215,
NAMAKKAL DI, TAMIL NADU.

[Signature]
Signature

Name of the Student: P. DamadhayalanBranch: MechanicalYear / Sem: IV - VII1. Name of the Training: ~~Profit Loss~~2. Name of the Trainer: Sowmiya

3. Students rating of Trainers :

S. No.	Date	Subject	Rating (✓)			
			Excellent	Very good	Good	Average
1	24.7.18	Profit Loss + Rabi Oand Profit		✓		

4. Two positive points about the programme:

- * Explain ~~for~~ ^{was} good
- * good knowledge in Trainers.

5. Suggestions for improvement:

improvement in Explanation

Date: 29.7.18
 P. Day
 Signature
Name of the Student: P. GokulBranch: MechanicsYear / Sem: V / VI1. Name of the Training: Profit and Loss in trade calculation (T2S)2. Name of the Trainer: Sowmiya

3. Students rating of Trainers :

S. No.	Date	Subject	Rating (✓)			
			Excellent	Very good	Good	Average
1	24/7/18	Profit and Loss		✓		

4. Two positive points about the programme:

- It is useful to improve our knowledge

5. Suggestions for improvement:

 need
 better to explain clearly.
Date: 24/07/18
 P. G.
 Signature
 PRINCIPAL,
 K. S. R. INSTITUTE FOR
 ENGINEERING AND TECHNOLOGY,
 K. S. R. KALANAGAR,
 TIRUCHENGODE - 637 215,
 NAMAKKAL DISTRICT, TAMIL NADU.

Name of the Student: B. NISHANTHIBranch: MECHANICALYear / Sem: IV / VII1. Name of the Training: PLACEMENT TRAINING - APTITUDE2. Name of the Trainer: PAVITHRA

3. Students' rating of Trainers :

S. No.	Date	Subject	Rating (√)			
			Excellent	Very good	Good	Average
1	23.07.18	Numbers, Average		✓		

4. Two positive points about the programme:

Explained briefly about the topics and teach again until the students got a clear idea.

5. Suggestions for improvement:

of the topic May have immediate small assessment after the completion in the classroom itself.

Date: 23.07.18R. N. Shetty
SignatureK S R INSTITUTE FOR ENGINEERING AND TECHNOLOGY
TIRUCHENGODE - 637 215

TRAINING PROGRAMME FEEDBACK FORM

Name of the Student: P. PRINSHITHBranch: MECHANICALYear / Sem: IV / VII4. Name of the Training: PLACEMENT TRAINING - APTITUDE5. Name of the Trainer: PAVITHRA

6. Students' rating of Trainers :

S. No.	Date	Subject	Rating (√)			
			Excellent	Very good	Good	Average
1	23.07.18	Numbers, Average		✓		

4. Two positive points about the programme:

Explained with detail explanation and it will be useful for the training students starting from Basic Level

5. Suggestions for improvement:

Need to Improve the clarification of student's Doubt's immediately

Date: 23.07.18D. J. J.
Signature

PRINCIPAL,
K. S. R. INSTITUTE FOR
ENGINEERING AND TECHNOLOGY,
K. S. R. KALVI NAGAR,
TIRUCHENGODE-637 215,
NAMAKKAL DL, TAMIL NADU.

Name of the Student: Kishor Kumar MBranch: Mechanical 31Year / Sem: IV / 1st1. Name of the Training: Attitude2. Name of the Trainer: PREMA & PAVITHRA3. Students rating of Trainers: 8.5

S. No.	Date	Subject	Rating (✓)			
			Excellent	Very good	Good	Average
1	23.7.18	Attitude	✓			

4. Two positive points about the programme: Trainers good.5. Suggestions for improvement: nothing (will).

Date:

Signature:

Name of the Student: Linga ShivanBranch: Mechanical EngineeringYear / Sem: IV / VI4. Name of the Training: Attitude5. Name of the Trainer: PREMA & PAVITHRA6. Students rating of Trainers: 8.5

S. No.	Date	Subject	Rating (✓)			
			Excellent	Very good	Good	Average
1	23.7.18	Attitude	✓			

4. Two positive points about the programme: Trainers good
well experienced

5. Suggestions for improvement:

Date: 23/7/18

NP1

PRINCIPAL
K. S. R. INSTITUTE FOR
ENGINEERING AND TECHNOLOGY,
K. S. R. KALVI NAGAR,
TIRUCHENGODE-637 215,
NAMAKKAL DISTRICT, TAMIL NADU.

Signature:

Name of the Student: SUBHASH .SBranch: MECHANICAL - C secYear / Sem: IV YEAR / VII SEM1. Name of the Training: PREMA APPTITUDE TRAINING2. Name of the Trainer: PREMA / PAVITHRA

3. Students rating of Trainers :

S. No.	Date	Subject	Rating (✓)			
			Excellent	Very good	Good	Average
1	23.7.18	Apptitude Training		✓		

4. Two positive points about the programme:

Easy learning

5. Suggestions for improvement:

Activities at afternoon sessionDate: 23.07.2018Signature S. SubashName of the Student: D. Pravinth. KBranch: MechanicalYear / Sem: IV / VII4. Name of the Training: Apptitude Training5. Name of the Trainer: PREMA / PAVITHRA

6. Students rating of Trainers :

S. No.	Date	Subject	Rating (✓)			
			Excellent	Very good	Good	Average
1	23.7.18	Apptitude Training		✓		

4. Two positive points about the programme:

Easy learning
new ideas

5. Suggestions for improvement:

Activities at afternoonDate: 23/7/18

PRINCIPAL,
K. S. R. INSTITUTE FOR ENGINEERING AND TECHNOLOGY,
K. S. R. KALVI NAGAR,
TIRUCHENGODE-637 215,
NAMAKKAL DL, TAMIL NADU.

Signature [Signature]

Name of the Student: P. R. ManojkumarBranch: MechanicalYear / Sem: IV / VII1. Name of the Training: Aptitude2. Name of the Trainer: A. Manojkumar

3. Students rating of Trainers :

S. No.	Date	Subject	Rating (✓)			
			Excellent	Very good	Good	Average
1	23/7/18	Percentage, blood relation	✓			

4. Two positive points about the programme:

1) To increase the Problem solving Capacity of Percentage

5. Suggestions for improvement:

To solve back problem in material

Date: 23/7/18

P. R. Manojkumar
Signature

K S R INSTITUTE FOR ENGINEERING AND TECHNOLOGY
TIRUCHENGODE - 637 215

TRAINING PROGRAMME FEEDBACK FORM

Name of the Student: S. A. Jivan AkshayBranch: MechanicalYear / Sem: IV / VII4. Name of the Training: Aptitude5. Name of the Trainer: A. Manojkumar

6. Students rating of Trainers :

S. No.	Date	Subject	Rating (✓)			
			Excellent	Very good	Good	Average
1	23/7/18	Percentage Blood relation	✓			

4. Two positive points about the programme:

The program is so interested in Percentage of
Blood relation

5. Suggestions for improvement:

Due to fast teaching it is difficult
to catch

Date: 23/7/18

S. A. Jivan Akshay
Signature
K S R INSTITUTE FOR
ENGINEERING AND TECHNOLOGY,
K. S. R. KALVI NAGAR,
TIRUCHENGODE-637 215,
NAMAKKAL DI, TAMIL NADU.



Name of the Student: R. DHANASEKAR

Branch: B.E - MECHANICAL

Year / Sem: IV - VII

1. Name of the Training: APTITUDE

2. Name of the Trainer: PREMA / PAVITHRA

3. Students rating of Trainers :

S. No.	Date	Subject	Rating (✓)			
			Excellent	Very good	Good	Average
1	23.7.18	APTITUDE	✓			

4. Two positive points about the programme:

MY APTITUDE KNOWLEDGE IS IMPROVE

5. Suggestions for improvement:

Date: 23.7.18

R. Dhanasekar
Signature



Name of the Student: M. Balaji

Branch: BE - MECHANICAL

Year / Sem: Final year - A

4. Name of the Training: APTITUDE -> (Talent & Success)

5. Name of the Trainer: PREMA / PAVITHRA

6. Students rating of Trainers :

S. No.	Date	Subject	Rating (✓)			
			Excellent	Very good	Good	Average
1	23/07/18	APTITUDE		✓		

4. Two positive points about the programme:

APTITUDE KNOWLEDGE IS GAINING.
SHORTCUTS FOR SOLVING PROBLEMS IS EASY

5. Suggestions for improvement:

Keep Going

Date: 23/07/18

PRINCIPAL,
K. S. R. INSTITUTE FOR
ENGINEERING AND TECHNOLOGY
K. S. R. KALVI NAGAR,
TIRUCHENGODE-637 215,
NAMAKKAL DI, TAMIL NADU.

Signature

M. Balaji



Name of the Student: R. cellakamalalakshmi Branch: Mech - A

Year / Sem: IV / VU

4. Name of the Training :

5. Name of the Trainer : Manoj kumar

6. Students rating of Trainers :

S. No.	Date	Subject	Rating (✓)			
			Excellent	Very good	Good	Average
1	23/7/18	Number system	✓			

4. Two positive points about the programme: Easy to learn about Number theory, Averages, % , blood relation.

5. Suggestions for improvement:

Date: 23/7/18 I want to learn ~~know~~ more about blood relation Signature R. cell

more about blood relation



Name of the Student: S. AJITH KUMAR Branch: Mechanical

Year / Sem: IV / VII

4. Name of the Training : prema Blood relation & percentage

5. Name of the Trainer : prema

6. Students rating of Trainers :

S. No.	Date	Subject	Rating (✓)			
			Excellent	Very good	Good	Average
1	23.7.18	percentage		✓		

4. Two positive points about the programme: We improve the general knowledge, Easy to learning the question so

5. Suggestions for improvement: from answer

Date: 23.7.18

Trainers should have more interact with students
PRINCIPAL
K. S. R. INSTITUTE FOR ENGINEERING AND TECHNOLOGY,
K. S. R. KALVI NAGAR,
TIRUCHENGODE-637 215,
NAMAKKAL DI, TAMIL NADU.



Name of the Student: A.S. Gnana Prakash

Branch: B.E. Mech Final yr.

Year / Sem: Final yr / VII

1. Name of the Training: Aptitude.

2. Name of the Trainer: Mangaj Kumar.

3. Students rating of Trainers :

S. No.	Date	Subject	Rating (✓)			
			Excellent	Very good	Good	Average
1	23/7/18	Average, wit digit	✓			

4. Two positive points about the programme: * It is Very useful to solve addition, subtraction is ^{straight}

* It is Very helpful to improve our skills

5. Suggestions for improvement: Nothing

Date: 23/7/18

A.S. Gnana Prakash
Signature



Name of the Student: Thamil Selvam S

Branch: Mech

Year / Sem: iv / VII

1. Name of the Training: T25

2. Name of the Trainer: Prema

3. Students rating of Trainers : 75/10

S. No.	Date	Subject	Rating (✓)			
			Excellent	Very good	Good	Average
1	23/7/18	Percentage	✓			

4. Two positive points about the programme:

Trainers have good skills
Easy to learn about aptitude skills

5. Suggestions for improvement:

More interaction
More exercises

Date: 23/7/18

Prema
Signature
K. S. R. INSTITUTE OF TECHNOLOGY,
K. S. R. KALVI NAGAR,
TIRUCHENGODE - 637 215, TAMIL NADU.



Name of the Student: B. Omadhavan Branch: MECH

Year / Sem: IV / VII

1. Name of the Training: Attitude
 2. Name of the Trainer: Prema/Panithra
 3. Students rating of Trainers :

S. No.	Date	Subject	Rating (√)			
			Excellent	Very good	Good	Average
1	23/7/18	Number System Average, Percentage	✓			

4. Two positive points about the programme: It helps to solve problems easily.
It increases mental ability of calculations.

5. Suggestions for improvement: Only Facility is For full Day Training.

Date: 23/07/18

Signature



Name of the Student: N. NAVEEN Branch: MECH

Year / Sem: IV / VII

4. Name of the Training: Attitude
 5. Name of the Trainer: Prema/Panithra
 6. Students rating of Trainers :

S. No.	Date	Subject	Rating (√)			
			Excellent	Very good	Good	Average
1	23/7/18	Number System Ave, %, B.P.S.M	✓			

4. Two positive points about the programme: I have improve our Knowledge
To easy to solve the Questions.

5. Suggestions for improvement: To solve more Question in
board

Date: 23/07/18

PRINCIPAL.
K. S. R. INSTITUTE FOR
ENGINEERING AND TECHNOLOGY,
K. S. R. KALVI NAGAR,
TIRUCHENGODE-637 215,
NAMAKKAL Dt, TAMIL NADU.

Signature



MECH A, B & C Aptitude, Reasoning & Verbal Training Programme by
Talent 2 Success Learning

BATCH: 2015 - 2019

ACADEMIC YEAR: 2018 - 2019 (ODD)

DATE: 25.07.2018

Fore Noon session

S.NO	Branch	Strength	Present	Absent	Permission
1	Batch 1	47	46	0	1
2	Batch 2	47	46	0	1
3	Batch 3	45	43	0	2
Total		139	135	0	4

After Noon session

S.NO	BRANCH	Strength	Present	Absent	Leave
1	Batch 1	47	46	0	1
2	Batch 2	47	46	0	1
3	Batch 3	45	43	0	2
Total		139	135	0	4

Y. Kaluth
T & P OFFICER

[Signature]
T&P CO ORDINATOR

[Signature]
PRINCIPAL

[Green Checkmark]
PRINCIPAL,
K. S. R. INSTITUTE FOR
ENGINEERING AND TECHNOLOGY,
K. S. R. KALVI NAGAR,
TIRUCHENGODE-637 215,
NAMAKKAL DI, TAMIL NADU.

TRAINING & PLACEMENT CELL



MECH A, B & C Aptitude, Reasoning & Verbal Training Programme by
Talent 2 Success Learning

BATCH: 2015 - 2019

ACADEMIC YEAR: 2018 - 2019 (ODD)

DATE: 26.07.2018

Fore Noon session

S.NO	Branch	Strength	Present	Absent	Permission
1	Batch 1	47	45	0	2
2	Batch 2	47	46	0	1
3	Batch 3	45	43	0	2
Total		139	134	0	5

After Noon session

S.NO	BRANCH	Strength	Present	Absent	Leave
1	Batch 1	47	45	0	2
2	Batch 2	47	46	0	1
3	Batch 3	45	43	0	2
Total		139	134	0	5

V. Kalvi
T & P OFFICER
26/7

[Signature]
T&P CO ORDINATOR

[Signature]
PRINCIPAL

PRINCIPAL,
K. S. R. INSTITUTE FOR
ENGINEERING AND TECHNOLOGY,
K. S. R. KALVI NAGAR,
TIRUCHENGODE-637 215,
NAMAKKAL Dt, TAMIL NADU.

TRAINING & PLACEMENT CELL



MECH A, B & C Aptitude, Reasoning & Verbal Training Programme by
Talent 2 Success Learning

BATCH: 2015 - 2019

ACADEMIC YEAR: 2018 - 2019 (ODD)

DATE: 27.07.2018

Fore Noon session

S.NO	Branch	Strength	Present	Absent	Permission
1	Batch 1	47	45	0	2
2	Batch 2	47	46	0	1
3	Batch 3	45	43	0	2
Total		139	134	0	5

After Noon session

S.NO	BRANCH	Strength	Present	Absent	Leave
1	Batch 1	47	45	0	2
2	Batch 2	47	46	0	1
3	Batch 3	45	43	0	2
Total		139	134	0	5

[Signature]
T & P OFFICER

[Signature]
T&P CO ORDINATOR

[Signature]
PRINCIPAL

PRINCIPAL
K. S. R. INSTITUTE FOR
ENGINEERING AND TECHNOLOGY,
K. S. R. KALVI NAGAR,
TIRUCHENGODE-637 215,
NAMAKKAL DI, TAMIL NADU.

TIRUCHENGODE - 637 215
 TRAINING PROGRAMME FEEDBACK FORM



Name of the Student: R. Kevin Kumar Branch: Mechanical

Year / Sem: IV / VII

1. Name of the Training: Verbal Aptitude

2. Name of the Trainer: N. Saravanan

3. Students rating of Trainers :

S. No.	Date	Subject	Rating (√)			
			Excellent	Very good	Good	Average
1	25.7.18	Verbal Aptitude	✓			

4. Two positive points about the programme:

I am learning in the Idioms & Phrases

5. Suggestions for improvement: I am easy to understanding sentence improvement

(NIL)

Date: 25-7-18

R. K. S.
Signature

K S R INSTITUTE FOR ENGINEERING AND TECHNOLOGY
 TIRUCHENGODE - 637 215

TRAINING PROGRAMME FEEDBACK FORM



Name of the Student: Pavana Sarasathi AT Branch: Mech

Year / Sem: IV / A

4. Name of the Training: Aptitude

5. Name of the Trainer: Saravanan . N

6. Students rating of Trainers :

S. No.	Date	Subject	Rating (√)			
			Excellent	Very good	Good	Average
1	25/7/18	Verbal Aptitude	✓			

4. Two positive points about the programme:

Superior Understanding

5. Suggestions for improvement:

Nothing

Date: 25/7/18

PRINCIPAL,
 K. S. R. INSTITUTE FOR
 ENGINEERING AND TECHNOLOGY,
 K. S. R. KALVI NAGAR,
 TIRUCHENGODE-637 215,
 NAMAKKAL DI, TAMIL NADU.

[Signature]
Signature

TIRUCHENGODE - 637 215
 TRAINING PROGRAMME FEEDBACK FORM



Name of the Student: S. Jagdeshwaram

Branch: Mechanical - A

Year / Sem: N/VII

1. Name of the Training: Verbal aptitude

2. Name of the Trainer:

3. Students rating of Trainers:

S. No.	Date	Subject	Rating (✓)			
			Excellent	Very good	Good	Average
1	25/7/18	Verbal	✓			

4. Two positive points about the programme: Come to know about the word meaning
Easy to solve word problems.

5. Suggestions for improvement:

More topics.
More activities.

Date: 25/7/18

S. Jagdeshwaram
 Signature

K S R INSTITUTE FOR ENGINEERING AND TECHNOLOGY
 TIRUCHENGODE - 637 215

TRAINING PROGRAMME FEEDBACK FORM



Name of the Student: Sai Harish. V

Branch: Mechanical - E

Year / Sem: IV / VII

4. Name of the Training: verbal

5. Name of the Trainer: Cathrine.

6. Students rating of Trainers:

S. No.	Date	Subject	Rating (✓)			
			Excellent	Very good	Good	Average
1	25/7/18	Verbals	✓			

4. Two positive points about the programme: To know about new words
and their meanings

5. Suggestions for improvement:

more training classes we want Pbz.

Date:

25/7/18

PRINCIPAL,
 K. S. R. INSTITUTE FOR
 ENGINEERING AND TECHNOLOGY
 K. S. R. KALVI NAGAR,
 TIRUCHENGODE-637 215,
 NAMAKKAL Dt, TAMIL NADU.
V. Suresh
 Signature

K S R INSTITUTE FOR ENGINEERING AND TECHNOLOGY
TIRUCHENGODE - 637 215
TRAINING PROGRAMME FEEDBACK FORM



Name of the Student: P. Kumar Branch: Mech
Year / Sem: IV / VII

1. Name of the Training : Appitude Training
2. Name of the Trainer : Cathrina
3. Students rating of Trainers :

S. No.	Date	Subject	Rating (√)			
			Excellent	Very good	Good	Average
1	25.07.18	verbel	✓			

4. Two positive points about the programme:

(i) learning verbel (ii) avoid stage fear

5. Suggestions for improvement:

To conduct activities

Date: 25.04.18

L. S. Srinivas
Signature

K S R INSTITUTE FOR ENGINEERING AND TECHNOLOGY
TIRUCHENGODE - 637 215
TRAINING PROGRAMME FEEDBACK FORM



Name of the Student: Bharathi. K. V Branch: Mechanical
Year / Sem: Final / VII

4. Name of the Training : Appitude Training
5. Name of the Trainer : Cathrina
6. Students rating of Trainers :

S. No.	Date	Subject	Rating (√)			
			Excellent	Very good	Good	Average
1	25.07.18	Verbel		✓		

4. Two positive points about the programme:

learned new words, new activities have done

5. Suggestions for improvement:

skill not satisfied by activity so conduct it more

Date:

PRINCIPAL,
K. S. R. INSTITUTE FOR
ENGINEERING AND TECHNOLOGY,
K. S. R. KALVI NAGAR,
TIRUCHENGODE-637 215,
NAMAKKAL DL, TAMIL NADU.

[Signature]
Signature

TRAINING PROGRAMME FEEDBACK FORM

Name of the Student: K. Yogesh

Branch: Mechanical

Year / Sem: V / VI

4. Name of the Training: verbal aptitude

5. Name of the Trainer: N. Saravanan

6. Students rating of Trainers :

S. No.	Date	Subject	Rating (✓)			
			Excellent	Very good	Good	Average
1	25.7.18	verbal aptitude	✓			

4. Two positive points about the programme: self motivated

trained some verbal skills

5. Suggestions for improvement:

Date: 25.7.18

K. Yogesh
Signature

PRINCIPAL,
K. S. R. INSTITUTE FOR
ENGINEERING AND TECHNOLOGY,
K. S. R. KALVI NAGAR,
TIRUCHENGODE-637 215,
NAMAKKAL Dt, TAMIL NADU.

Name of the Student: A. Thagappillai Branch: MechYear / Sem: IV / VII1. Name of the Training: distance and time.2. Name of the Trainer: Alok Singh.

3. Students rating of Trainers :

S. No.	Date	Subject	Rating (√)			
			Excellent	Very good	Good	Average
1	25.7.18	distance & time, syllogism.	✓			

4. Two positive points about the programme:

Logical thinking.

5. Suggestions for improvement:

Date: 25/7/18Signature [Signature]K S R INSTITUTE FOR ENGINEERING AND TECHNOLOGY
TIRUCHENGODE - 637 215

TRAINING PROGRAMME FEEDBACK FORM

Name of the Student: R. Sanykumar Branch: MechYear / Sem: IV / VII4. Name of the Training: distance and time5. Name of the Trainer: Alok Singh.

6. Students rating of Trainers :

S. No.	Date	Subject	Rating (√)			
			Excellent	Very good	Good	Average
1	25.7.2018	distance and time.			✓	

4. Two positive points about the programme:

Shortcuts Mathematics.

5. Suggestions for improvement:

More shortcutsDate: 25/7/2018

PRINCIPAL, [Signature]
K. S. R. INSTITUTE FOR ENGINEERING AND TECHNOLOGY,
K. S. R. KALVI NAGAR,
TIRUCHENGODE-637 215,
NAMAKKAL, DR. TAMIL NADU.



Name of the Student: S. Keerthi Kumar

Branch: Mechanical

Year / Sem: V / II

1. Name of the Training : TIME T25

2. Name of the Trainer : Alok Singh

3. Students rating of Trainers :

S. No.	Date	Subject	Rating (√)			
			Excellent	Very good	Good	Average
1	25-7-18	Time, work distance, syllabus	✓			

4. Two positive points about the programme:

Reading skills improvement
logical thinking improved

5. Suggestions for improvement:

Solving problem apart from materials

Date: 25/7/18

S. Keerthi
Signature



Name of the Student: B. THIRU MOORTHY

Branch: MECHANICAL

Year / Sem: V / II

4. Name of the Training : T25

5. Name of the Trainer : Alok SINGH

6. Students rating of Trainers :

S. No.	Date	Subject	Rating (√)			
			Excellent	Very good	Good	Average
1	25.7.18	TIME & WORK SYLLOBIISM	✓			

4. Two positive points about the programme:

TIME MANAGEMENT SKILL IMPROVED
COMPLEX PROBLEMS EASILY SOLVED

5. Suggestions for improvement:

NEED MORE SHORTCUT METHODS

Date: 25.7.18

[Signature]
Signature

PRINCIPAL,
K. S. R. INSTITUTE FOR
ENGINEERING AND TECHNOLOGY,
K. S. R. KALVI NAGAR,
TIRUCHENGODE-637 215,
NAMAKKAL DL, TAMIL NADU.



Name of the Student: S. Ragu

Branch: Mechanical Engineering

Year / Sem: IV - 7th

1. Name of the Training: Vinothini. S

2. Name of the Trainer: Placement Training (Aptitude)

3. Students rating of Trainers :

S. No.	Date	Subject	Rating (✓)			
			Excellent	Very good	Good	Average
1	26/7/18	Quantitative Aptitude	✓			

D3

4. Two positive points about the programme:

* Easy way of using shortcuts not Equations or formulas

5. Suggestions for improvement:

* Good Interaction
* Extend placement Training classes

Date: 26/7/18

S. Ragu
Signature



Name of the Student: Puvvarasan

Branch: Mechanical Engineering

Year / Sem: IV, 7th

4. Name of the Training: Placement Training (Aptitude)

5. Name of the Trainer: Vinothini. S.

6. Students rating of Trainers :

S. No.	Date	Subject	Rating (✓)			
			Excellent	Very good	Good	Average
1	26/7/18	Quantitative Aptitude	✓			

D3.

4. Two positive points about the programme:

* Easy way of solving Aptitude Questions.

5. Suggestions for improvement:

* Good interaction

Date: 26/7/18

P. Anusuy. N.
PRINCIPAL
K. S. R. INSTITUTE FOR
ENGINEERING AND TECHNOLOGY,
K. S. R. KALVI NAGAR,
TIRUCHENGODE-637 215,
NAMAKKAL DISTRICT, TAMIL NADU.

TIRUCHENGODE - 637 215
 TRAINING PROGRAMME FEEDBACK FORM



206

Name of the Student: K. Yogesh Branch: Mechanical

Year / Sem: IV / 1

1. Name of the Training: D3
 2. Name of the Trainer: S. Vinodhini
 3. Students rating of Trainers :

S. No.	Date	Subject	Rating (✓)			
			Excellent	Very good	Good	Average
1	26.7.18	D3		✓		

4. Two positive points about the programme: Learned syllogism
learned how time plays an important role
 5. Suggestions for improvement:

Date: 26.7.18

R. V. D.
 Signature

K S R INSTITUTE FOR ENGINEERING AND TECHNOLOGY
 TIRUCHENGODE - 637 215
 TRAINING PROGRAMME FEEDBACK FORM



206

Name of the Student: SUBHASH S Branch: Mech - C

Year / Sem: IV / VII

4. Name of the Training: Syllogism, Time, Speed, Distance, Time & work
 5. Name of the Trainer: S. Vinodhini
 6. Students rating of Trainers :

S. No.	Date	Subject	Rating (✓)			
			Excellent	Very good	Good	Average
1	26.07.18	Day-3 subject		✓		

4. Two positive points about the programme: Knows some shortcut to solve the problem.
Improved skills
 5. Suggestions for improvement:

Date: 26.07.18

S. Vinodhini
 Signature
 PRINCIPAL,
 K. S. R. INSTITUTE FOR
 ENGINEERING AND TECHNOLOGY,
 K. S. R. KALVI NAGAR,
 TIRUCHENGODE-637 215,
 NAMAKKAL DI, TAMIL NADU.

K S R INSTITUTE FOR ENGINEERING AND TECHNOLOGY
TIRUCHENGODE - 637 215
TRAINING PROGRAMME FEEDBACK FORM



Name of the Student: M. Kishore Branch: Mechanical - E

Year / Sem: IV / VII

1. Name of the Training: Quantitative Aptitude

2. Name of the Trainer: Dhinakaran

3. Students rating of Trainers :

S. No.	Date	Subject	Rating (✓)			
			Excellent	Very good	Good	Average
1	26.7.18		✓			

4. Two positive points about the programme:

Good Teaching
Easy to listen

5. Suggestions for improvement:

No suggestions

Date:

M. Kishore
Signature

K S R INSTITUTE FOR ENGINEERING AND TECHNOLOGY
TIRUCHENGODE - 637 215
TRAINING PROGRAMME FEEDBACK FORM



Name of the Student: P.V. Aravindhan Branch: MECH - A

Year / Sem: IV / VII

4. Name of the Training: Quantitative Aptitude

5. Name of the Trainer: Dhinakaran

6. Students rating of Trainers :

S. No.	Date	Subject	Rating (✓)			
			Excellent	Very good	Good	Average
1	26/7/18			✓		

4. Two positive points about the programme:

we get lot of knowledge about problem solving & new ideas.

5. Suggestions for improvement:

Date:

P.V. Aravindhan
Signature
PRINCIPAL
K. S. R. INSTITUTE FOR
ENGINEERING AND TECHNOLOGY,
K. S. R. KALVI NAGAR,
TIRUCHENGODE-637 215,
NAMAKKAL DISTRICT, TAMIL NADU.

HW-208

TIRUCHENGODE - 637 215
TRAINING PROGRAMME FEEDBACK FORM



Name of the Student: JAGADEESH

Branch: MECH

Year / Sem: Final - year - A

1. Name of the Training : Prerna

2. Name of the Trainer : Prerna

3. Students rating of Trainers :

S. No.	Date	Subject	Rating (✓)			
			Excellent	Very good	Good	Average
1	26.07.18	Direction coding decoding	✓			

4. Two positive points about the programme: It is very easy understand
We can know more shortcuts

5. Suggestions for improvement:

Date: 26.07.18

[Signature]
Signature

K S R INSTITUTE FOR ENGINEERING AND TECHNOLOGY
TIRUCHENGODE - 637 215
TRAINING PROGRAMME FEEDBACK FORM



Name of the Student: L. SRIDHAR

Branch: MECH - C

Year / Sem: FINAL year - 11

4. Name of the Training : Prerna

5. Name of the Trainer : Prerna

6. Students rating of Trainers :

S. No.	Date	Subject	Rating (✓)			
			Excellent	Very good	Good	Average
1	26/07/18	presentation Acology, coding	✓			

4. Two positive points about the programme: it is very easy to understand
know more shortcuts

5. Suggestions for improvement:

Date: 26/07/18

[Signature]
Signature

PRINCIPAL
K. S. R. INSTITUTE FOR
ENGINEERING AND TECHNOLOGY,
K. S. R. KALVI NAGAR,
TIRUCHENGODE-637 215,
NAMAKKAL DISTRICT, TAMIL NADU.

[Signature]
Signature

Name of the Student: C. BenarBranch: BE Mech AYear / Sem: ~~IV/II~~ Final/VI

1. Name of the Training :

2. Name of the Trainer : Prema

3. Students rating of Trainers :

S. No.	Date	Subject	Rating (✓)			
			Excellent	Very good	Good	Average
1	26.07.2018	Permutation Combination	✓			

4. Two positive points about the programme:

Easy to understand. way of teaching is good.

5. Suggestions for improvement:

Date: 26.07.2018

Signature

C. BenarName of the Student: R. GopikaBranch: B.E Mechanical AYear / Sem: ~~IV/II~~ Final yr / A / VII

4. Name of the Training :

5. Name of the Trainer : Prema

6. Students rating of Trainers :

S. No.	Date	Subject	Rating (✓)			
			Excellent	Very good	Good	Average
1	26.7.18	Probability permutation	✓			

4. Two positive points about the programme:

Easy to learn. teaching is good.

5. Suggestions for improvement:

Date: 26.7.18

Signature

PRINCIPAL,
 K. S. R. INSTITUTE FOR
 ENGINEERING AND TECHNOLOGY,
 K. S. R. KALVI NAGAR,
 TIRUCHENGODE-637 215,
 NAMAKKAL DI, TAMIL NADU.

R. Gopika



TRAINING PROGRAMME FEEDBACK FORM

Name of the Student: K. Mohan Prabhu Branch: MECH - B

Year / Sem: IV / VII

1. Name of the Training: ~~Python~~ App Bitude

2. Name of the Trainer: Manoj Kumar, Parithra

3. Students rating of Trainers :

S. No.	Date	Subject	Rating (√)			
			Excellent	Very good	Good	Average
1	27-7-18	Day 4	✓			

4. Two positive points about the programme: * Concept are so easy.
* easy to understand everyone.

5. Suggestions for improvement: nothing

Date: 27-7-18

K. Mohan Prabhu
Signature



TRAINING PROGRAMME FEEDBACK FORM

Name of the Student: R. KARTHICK Branch: Mech - B

Year / Sem: IV / VII

4. Name of the Training: Python coding decoding etc.

5. Name of the Trainer: Manoj Kumar, Parithra

6. Students rating of Trainers :

S. No.	Date	Subject	Rating (√)			
			Excellent	Very good	Good	Average
1	27-7-18	Day-4		✓		

4. Two positive points about the programme: Very useful
Interactive mind.

5. Suggestions for improvement: -

Date: 27-7-18

PRINCIPAL,
K. S. R. INSTITUTE FOR
ENGINEERING AND TECHNOLOGY,
K. S. R. KALVI NAGAR,
TIRUCHENGODE-637 215,
NAMAKKAL DT, TAMIL NADU.

P. Karthick
Signature



Name of the Student: P Manikandan

Branch: Mechanical

Year / Sem: IV, 7th

1. Name of the Training: Reasoning

2. Name of the Trainer: Manoj

3. Students rating of Trainers :

S. No.	Date	Subject	Rating (✓)			
			Excellent	Very good	Good	Average
1	27/7/2018	Reasoning		✓		

4. Two positive points about the programme:

Easy way to calculate the Probability

5. Suggestions for improvement:

want to solve more problems.

Date: 27/07/18

Manoj
Signature



Name of the Student: R. Mohan kumar

Branch: Mechanical

Year / Sem: 4th, 7th

4. Name of the Training: Reasoning

5. Name of the Trainer: Manoj

6. Students rating of Trainers :

S. No.	Date	Subject	Rating (✓)			
			Excellent	Very good	Good	Average
1	27/07/18	Reasoning	✓			

4. Two positive points about the programme:

Easy to understand the concept of permutation, combination, probability

5. Suggestions for improvement:

NO suggestions.

Date: 27/07/18



R. Manoj
Signature

PRINCIPAL,
K. S. R. INSTITUTE FOR
ENGINEERING AND TECHNOLOGY,
K. S. R. KALVI NAGAR,
TIRUCHENGODE-637 215,
NAMANKAL DL, TAMIL NADU.

Name of the Student: P. Shyam SundarBranch: MechYear / Sem: IV / 071. Name of the Training: Verbal2. Name of the Trainer: Catherine3. Students rating of Trainers: 80%

S. No.	Date	Subject	Rating (✓)			
			Excellent	Very good	Good	Average
1	27.07.18	Verbal	✓			

4. Two positive points about the programme:

* Good Grammar

* Synonymy

5. Suggestions for improvement:

* No comments

Date: 27.07.18

Signature
Name of the Student: M. Santhosh KumarBranch: MechanicalYear / Sem: IV / 074. Name of the Training: Catherine5. Name of the Trainer: Verbal

6. Students rating of Trainers:

S. No.	Date	Subject	Rating (✓)			
			Excellent	Very good	Good	Average
1	27/07/18	Verbal	✓			

4. Two positive points about the programme:

* teaching is good

5. Suggestions for improvement:

* easy to learn

* No comments

Date: 27/07/18

— X —

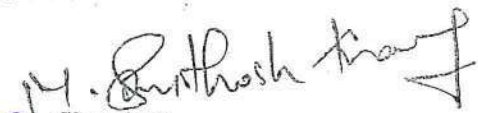
Signature
 PRINCIPAL,
K. S. R. INSTITUTE FOR
ENGINEERING AND TECHNOLOGY,
K. S. R. KALVI NAGAR,
TIRUCHENGODE-637 215,
NAMAKKAL Dt, TAMIL NADU.

Name of the Student: P. BHADRAHBranch: MECHANICALYear / Sem: IV - A1. Name of the Training: Workable2. Name of the Trainer: CATHRINE3. Students rating of Trainers: 4

S. No.	Date	Subject	Rating (✓)			
			Excellent	Very good	Good	Average
1	27-7-2018	workable	✓			

4. Two positive points about the programme:

* good training

* get shortcut of work.

5. Suggestions for improvement:

Date: 27-7-2018

P. Bhadrach
Signature

K S R INSTITUTE FOR ENGINEERING AND TECHNOLOGY
TIRUCHENGODE - 637 215

TRAINING PROGRAMME FEEDBACK FORM

Name of the Student: M. Subramanian - NBranch: MechanicalYear / Sem: IV - A4. Name of the Training: Workable5. Name of the Trainer: CATHRINE6. Students rating of Trainers: 4

S. No.	Date	Subject	Rating (✓)			
			Excellent	Very good	Good	Average
1	27-7-2018	workable	✓			

4. Two positive points about the programme:

* excellent GK on workable

* good workable provision.

5. Suggestions for improvement:

Date: 27-7-2018

Date:

PRINCIPAL
K. S. R. INSTITUTE FOR
ENGINEERING AND TECHNOLOGY,
K. S. R. KALVI NAGAR,
TIRUCHENGODE-637 215,
NAMAKKAL DISTRICT, TAMIL NADU.

[Signature]
Signature



Name of the Student: A. Balakumar

Branch: Mech

Year / Sem: IV / VI

1. Name of the Training : D-4

2. Name of the Trainer : Manoj Kumar

3. Students rating of Trainers :

S. No.	Date	Subject	Rating (✓)			
			Excellent	Very good	Good	Average
1	27.07.18.	D-4		✓		

4. Two positive points about the programme:

Easily to understand the classes.

5. Suggestions for improvement:

more than fastly in trainees in speech.

Date: 27.7.18

Signature: [Signature]



Name of the Student: Sai Harish V

Branch: Mech

Year / Sem: IV / VI

4. Name of the Training : placement (aptitude) Day- 4

5. Name of the Trainer : Pavithra

6. Students rating of Trainers :

S. No.	Date	Subject	Rating (✓)			
			Excellent	Very good	Good	Average
1	27/7/18	D-4		✓		

4. Two positive points about the programme:

- learnt many shortcuts
- time management

5. Suggestions for improvement:

Date: 27/7/18

PRINCIPAL.
K. S. R. INSTITUTE FOR
ENGINEERING AND TECHNOLOGY,
K. S. R. KALVI NAGAR,
TIRUCHENGODE-637 215,
NAMAKKAL DT, TAMIL NADU.

Signature: [Signature]

TRAINING PROGRAMME FEEDBACK FORM



Name of the Student: K. YOGESH RAHUL Branch: MECHANICAL - 'C'

Year / Sem: IV / VII

1. Name of the Training : permutation & combination, analogy, decoding
 2. Name of the Trainer : PAVITHRA, MANOJ KUMAR
 3. Students rating of Trainers :

S. No.	Date	Subject	Rating (✓)			
			Excellent	Very good	Good	Average
1	27.7.18	APTITUDE	✓			

4. Two positive points about the programme:

good, and satisfied with this class.

5. Suggestions for improvement:

Nothing to improve

Date: 27/7/18

Signature

TRAINING PROGRAMME FEEDBACK FORM



Name of the Student: Pavithra K Branch: mechanical - A

Year / Sem: IV / VII

4. Name of the Training : APTITUDE
 5. Name of the Trainer : MANOJ kumar
 6. Students rating of Trainers :

S. No.	Date	Subject	Rating (✓)			
			Excellent	Very good	Good	Average
1	27/7/18	probability direction, code	✓			

4. Two positive points about the programme:

Excellent & Good approach

5. Suggestions for improvement:

more problem

Date: 27/7/18

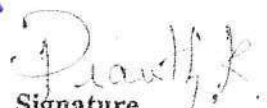
Signature

15, 16,

K S R INSTITUTE FOR ENGINEERING AND TECHNOLOGY, TIRUCHENGODE - 637 215

TRAINING AND PLACEMENT CELL



Training Schedule [2018 - 2019] Odd Semester

Ref: KSRIET/T&P/CIR/2018-19

Date: 16.08.2018

This is to inform that all the HoD's, Faculty and CSE, ECE, EEE & IT Department Training and Placement coordinator that the 4 Days External Training Programme for IV Year Students for the academic year 2018 - 2019 (Odd Sem) by Six Phrase has been scheduled. All the registered students should attend the Training Programme without fail. If any student skips this Training Programme without proper permission from the respective HoDs, he / she will not be permitted for any further Training Programme and campus recruitment process. Proper Dress Code is mandatory.

S.No	Date(s)	Venue(Class Room)	Department(Strength)
1	20.08.2018	Batch 1: 109	Batch 1: CSE - 10, ECE A - 6, ECE B - 5, EEE A-3, EEE B - 7 & IT - 11 Total- 42.
	21.08.2018		
	22.08.2018		
	23.08.2018		
2	27.08.2018	Batch 2: 108	Batch 2: ECE A - 21, ECE B - 16 & IT - 10 Total- 47.
	28.08.2018	Batch 3: 109	Batch 3: CSE - 7, EEE A- 19 & EEE B - 24. Total - 50.
	29.08.2018		
	30.08.2018		

V. S. Sahith
T&P OFFICER
16/8/18

T&P COORDINATOR
16/8/18

PRINCIPAL

Copy to:

1. All HoDs
2. Notice Board

Session Timings:

Forenoon Session: 09.00 am to 12.30 pm Break: 10.45 am to 11.00 am & 03.00 pm to 03.15 pm

Afternoon Session: 01.30 pm to 04.30 pm Lunch: 12.30 pm to 01.30 pm

Evening Assessment & Discussion: 05:00pm to 07:00 pm

PRINCIPAL
K. S. R. INSTITUTE FOR
ENGINEERING AND TECHNOLOGY,
K. S. R. KALVI NAGAR,
TIRUCHENGODE-637 215,
NAMAKKAL DI, TAMIL NADU.

Date of Training Programme				20.08.18		21.08.18		22.08.18		23.08.18	
S. No	Reg No	Name	Branch	FN	AN	FN	AN	FN	AN	FN	AN
1	731615104009	ELAKKIYA T.E	CSE	X	X	X	X	X	X	X	X
2	731615104012	GUNA BHARATHI T	CSE	X	X	X	X	X	X	X	X
3	731615104023	NISHA S	CSE	X	X	X	X	X	X	X	X
4	731615104033	SAKTHIVEL E	CSE	X	P	P	P	P	P	P	P
5	731615104007	BOOPATHIRAJA M	CSE	X	P	P	P	P	P	P	P
6	731615104016	KIRUBHANANDHAN P	CSE	X	P	P	P	P	P	P	P
7	731615104019	MOHANRAJ C	CSE	X	X	X	X	X	X	X	X
8	731615104044	VINOTHA V	CSE	X	X	X	X	X	X	X	X
9	731615104030	PRIYADHARSHINI R	CSE	X	X	X	X	X	X	X	X
10	731615104029	PRAVEEN G	CSE	X	X	X	X	X	X	X	X
11	731615106015	DHIVYA.M	ECE A	X	X	X	X	X	X	X	X
12	731615106029	JAYABHARATHI S	ECE A	X	X	X	X	X	X	X	X
13	731615106036	KAVIPREETHI V	ECE A	X	X	X	X	X	X	X	X
14	731615106009	BHUVANESWARI R	ECE A	X	X	X	X	X	X	X	X
15	731515106024	GOWRI P	ECE A	X	P	P	P	P	P	P	P
16	731615106041	KOWSALYA C	ECE A	X	X	X	X	X	X	X	X
17	731615106054	PAVITHRA P	ECE B	X	X	X	X	X	X	X	X
18	731615106073	SUGANTHI S	ECE B	X	X	X	X	X	X	X	X
19	731615106077	UMA MAHESHWARI M	ECE B	X	X	X	X	X	X	X	X
20	731615106079	VINOTHINI G	ECE B	X	X	X	X	X	X	X	X
21	731615106074	TAMILARASI J	ECE B	X	X	X	X	X	X	X	X
22	731615105044	KRISHNAMOORTHI S	EEE A	X	X	X	X	X	X	X	X
23	731615105002	ARUNKUMAR C	EEE A	X	P	P	P	P	P	P	P
24	731615105023	GOWTHAM S	EEE A	X	X	X	X	X	X	X	X
25	731615105049	MAHAESWARI A	EEE B	X	X	X	X	X	X	X	X
26	731615105073	SOUNDHARYA S	EEE B	X	X	X	X	X	X	X	X
27	731615105075	SRINITHI G	EEE B	X	X	X	X	X	X	X	X
28	731615105086	YOGAPRIYA S	EEE B	X	P	P	P	P	P	P	P
29	731615105076	SRINIVASAN R	EEE B	X	X	X	X	X	X	X	X
30	731615105077	STEPHEN IMMANUVEL J	EEE B	X	X	X	X	X	X	X	X

PRINCIPAL,
K. S. R. INSTITUTE FOR
ENGINEERING AND TECHNOLOGY,
K. S. R. KALVI NAGAR,
TIRUCHENGODE-637 215,
NAMAKKAL DI, TAMIL NADU.

Date of Training Programme				20.08.18		21.08.18		22.08.18		23.08.18	
S. No	Reg No	Name	Branch	FN	AN	FN	AN	FN	AN	FN	AN
31	731615105057	MURUGANANTH M	EEE B	X	X	X	X	X	X	X	X
32	731615205006	ARUNKUMAR.R	IT	X	X	X	X	X	X	X	X
33	731615205040	THIRUMALAIRAJAN.K	IT	X	P	P	P	P	P	P	P
34	731615205023	HEMALATHA.G	IT	X	X	X	X	X	X	X	X
35	731615205002	AISWARYA.R	IT	X	X	X	X	X	X	X	X
36	731615205014	DHARANI.P	IT	X	X	X	X	X	X	P	P
37	731615205036	SARAVANAPRIYA R	IT	X	X	X	X	X	X	X	X
38	731615205038	SNEKA D	IT	X	X	X	X	X	X	X	X
39	731615205012	DHANUSYADEVLS	IT	X	P	P	P	P	P	P	P
40	731615205016	DIVYA.R	IT	P	P	P	P	P	P	P	P
41	731615205019	ELANKANEI.M	IT	X	X	X	X	X	X	X	X
42	731615205022	GOWTHAM.R	IT	X	P	P	P	P	P	P	P
PRESENT				41	31	30	30	31			
ABSENT				-	-	-	-	0			
PERMISSION				1	11	5/10	6/10	1/10			

 PRINCIPAL
 K. S. R. INSTITUTE FOR
 ENGINEERING AND TECHNOLOGY,
 K. S. R. KALVI NAGAR,
 TIRUCHENGODE-637 215,
 NAMAKKAL Dt, TAMIL NADU.

Date of Training Programme				24/8						
S. No	Reg No	Name	Branch	FN	AN	FN	AN	FN	AN	FN
1	731615104009	ELAKKIYA T.E	CSE	P	P					
2	731615104012	GUNA BHARATHI T	CSE	X	X					
3	731615104023	NISHA S	CSE	P	X					
4	731615104033	SAKTHIVEL E	CSE	P	P					
5	731615104007	BOOPATHIRAJA M	CSE	P	P					
6	731615104016	KIRUBHANANDHAN P	CSE	P	P					
7	731615104019	MOHANRAJ C	CSE	X	X					
8	731615104044	VINOTHA V	CSE	X	X					
9	731615104030	PRIYADHARSHINI R	CSE	X	X					
10	731615104029	PRAVEEN G	CSE	X	X					
11	731615106015	DHIVYA.M	ECE A	X	X					
12	731615106029	JAYABHARATHI.S	ECE A	X	X					
13	731615106036	KAVIPREETHI.V	ECE A	X	X					
14	731615106009	BHUVANESWARI.R	ECE A	X	X					
15	731615106024	GOWRI.P	ECE A	P	P					
16	731615106041	KOWSALYA.C	ECE A	X	X					
17	731615106054	PAVITHRA P	ECE B	X	X					
18	731615106073	SUGANTHI S	ECE B	X	X					
19	731615106077	UMA MAHESHWARI M	ECE B	X	X					
20	731615106079	VINOTHINI G	ECE B	X	X					
21	731615106074	TAMILARASI J	ECE B	X	X					
22	731615105044	KRISHNAMOORTHIS	EEE A	X	X					
23	731615105002	ARUNKUMAR C	EEE A	P	P					
24	731615105023	GOWTHAM S	EEE A	X	X					
25	731615105049	MAHAESWARI A	EEE B	X	X					
26	731615105073	SOUNDHARYA S	EEE B	X	X					
27	731615105075	SRINITHI G	EEE B	X	P					
28	731615105086	YOGAPRIYA S	EEE B	P	P					
29	731615105076	SRINIVASAN R	EEE B	X	X					
30	731615105077	STEPHEN IMMANUVEL J	EEE B	AB	AB					

PRINCIPAL,
K. S. R. INSTITUTE FOR
ENGINEERING AND TECHNOLOGY,
K. S. R. KALVI NAGAR,
TIRUCHENGODE-637 215,
NAMAKKAL Dt, TAMIL NADU.

Date of Training Programme				24/8/18						
S. No	Reg No	Name	Branch	FN	AN	FN	AN	FN	AN	FN
31	731615105057	MURUGANANTH M	EEE B	X	X					
32	731615205006	ARUNKUMAR.R	IT	X	X					
33	731615205040	THIRUMALAIRAJAN.K	IT	P	P					
34	731615205023	HEMALATHA.G	IT	X	X					
35	731615205002	AISWARYA.R	IT	X	X					
36	731615205014	DHARANI.P	IT	X	X					
37	731615205036	SARAVANAPRIYA R	IT	P	X					
38	731615205038	SNEKA D	IT	X	X					
39	731615205012	DHANUSYADEVLS	IT	P	P					
40	731615205016	DIVYA.R	IT	P	P					
41	731615205019	ELANKANEI.M	IT	X	X					
42	731615205022	GOWTHAM.R	IT	P	P					
PRESENT										
ABSENT										
PERMISSION										

 PRINCIPAL.
 K. S. R. INSTITUTE FOR
 ENGINEERING AND TECHNOLOGY,
 K. S. R. KALVI NAGAR,
 TIRUCHENGODE-637 215,
 NAMAKKAL DISTRICT, TAMIL NADU.

K S R INSTITUTE FOR ENGINEERING AND TECHNOLOGY, Tiruchengode

Training and Placement Cell

Batch 2- Quantitative, Reasoning & Verbal Training by Six Phrase

ATCH: 2015 - 2019

Sem: Odd

Hall: 108

Academic Year: 2018 - 2019

Date of Training Programme				28.08.18		29.08.18		30.08.18		31.08.18	
S. No	Reg No	Name	Branch	FN	AN	FN	AN	FN	AN	FN	AN
1	731615205005	ARAVIND KUMAR.V	IT	NA	NA	NA	NA	NA			
2	731615205008	BALAJI.S	IT	NA	NA	NA	NA	NA			
3	731615205011	DENMOZHI.S	IT	P	P	/	/	/	a	a	a
4	731615205018	ELANGO VAN.S	IT	P	P	P	P	/	a	/	/
5	731615205021	GOWSIKKANNAN.V	IT	/	/	/	P	/	/	/	/
6	731615205026	MANOJKUMAR.D	IT	/	/	/	/	/	/	/	/
7	731615205029	PRIYANKA.S	IT	/	/	a	/	/	a	a	a
8	731615205031	RAMESH.A	IT	/	/	/	/	/	/	/	/
9	731615205035	RINESH.R	IT	P	P	a	a	a	a	a	a
10	731615205039	SUNDARAMOORTHI.G	IT	NA	NA	NA	NA	NA			
11	731615106001	ALEXRAJ.A	ECE A	/	/	/	D	/	a	/	/
12	731615106002	ANBARASAN.S	ECE A	NA	NA	NA	NA	NA	NA	NA	NA
13	731615106003	ARUNKUMAR.A	ECE A	NA	NA	NA	NA	NA	NA	NA	NA
14	731615106006	BHARATHI.D	ECE A	/	/	/	/	/	a	/	/
15	731615106012	DEVI.U	ECE A	P	P	/	D	/	/	/	/
16	731615106013	DHARANIR	ECE A	P	P	P	P	P	P	/	/
17	731615106014	DHAYALI.G	ECE A	a	a	a	a	a	a	/	/
18	731615106016	DIVYA.S	ECE A	/	/	/	/	/	/	/	/
19	731615106017	DIVYA.S	ECE A	/	/	/	/	/	/	/	/
20	731615106018	EZHILM	ECE A	/	/	/	/	/	/	/	/
21	731615106020	GAYATHRI.R	ECE A	P	L	/	/	/	/	/	/
22	731615106023	GOPALAKRISHNAN.R	ECE A	NA	NA	NA	NA	NA			
23	731615106025	HARINI.T	ECE A	/	/	/	/	/	/	/	/
24	731615106027	HEMALATHA.T	ECE A	/	/	/	/	/	/	/	/
25	731615106032	KARTHIKA.D	ECE A	/	/	/	/	/	/	/	/
26	731615106033	KARTHIKEYAN.P	ECE A	NA	NA	NA	NA	NA			
27	731615106034	KARTHIKEYAN.S	ECE A	/	/	/	a	a	a	a	a
28	731615106035	KATHIRAVAN.M	ECE A	NA	NA	NA	NA	NA			
29	731615106037	KEERTHANA.L	ECE A	/	/	/	/	/	/	/	/
30	731615106302	PRATHEEP S	ECE A	A	/	A	A	A	A	/	/
31	731615106303	RAMKUMAR L	ECE A	/	/	/	/	/	/	a	a
32	731615106042	LOGAPRIYA.M	ECE B	/	/	/	/	/	/	/	/
33	731615106045	NARESH.N	ECE B	/	/	/	/	/	/	/	/
34	731615106046	NAVEEN.T.S	ECE B	NA	NA	NA	NA	NA			
35	731615106052	PALANIVELU G	ECE B	NA	/	/	/	/	/	/	/
36	731615106056	PRADHIP R R	ECE B	NA	NA	NA	NA	NA			
37	731615106057	PRAVEEN KUMAR V	ECE B	P	P	P	P	P	P	a	a

PRINCIPAL,
K. S. R. INSTITUTE FOR
ENGINEERING AND TECHNOLOGY,
K. S. R. KALVI NAGAR,
TIRUCHENGODE - 637 215,
TAMIL NADU.

Date of Training Programme				28.08.18		29.08.18		30.08.18		31.08.18	
S. No	Reg No	Name	Branch	FN	AN	FN	AN	FN	AN	FN	AN
38	731615106059	PRIYADHARSHINI.S	ECE B	/	/	/	/	/	/	/	/
39	731615106064	RANJITH RAJA M	ECE B	/	/	/	/	/	/	L	a
40	731615106066	SARANYA.M	ECE B	/	/	P	P	a	a	A	/
41	731615106067	SARASWATHI P	ECE B	/	/	a	a	a	a	A	a
42	731615106069	SELVARAKESHKUMAR C	ECE B	/	/	a	a	/	/	/	/
43	731615106071	SRIDHAR C	ECE B	/	/	/	/	/	/	/	/
44	731615106072	SRIDHARAN.S	ECE B	a	a	a	a	/	/	/	/
45	731615106076	THARUNYA.S	ECE B	/	/	a	a	/	/	/	/
46	731615106078	VINAY.V	ECE B	/	/	/	/	/	/	/	/
47	731615106082	YOGESH E V	ECE B	/	/	/	/	/	/	/	/
PRESENT											
ABSENT											
PERMISSION											

48 PHANUSYADEVI.S IT P P P / / / ~~/~~ /

Time:

09:00 - 11:00 - Session - I

11:15 - 12:45 - Session - II

01:45 - 03:00 - Session - III

3:10 - 4:30 - Session - IV

05:00 - 06:30 - Test & Discussion

Break

11:00 - 11:15

12:45 - 01:45

03:00 - 03:10

10, 16, 18, 21, 44

ECE-A ECE-B

R-16 R-14

P-13 P-8

Pn-1 Pn-2

Ab-2 Ab-4

Dhanyali - Not Informed

Prathibha - Not Informed

Saraswathi - Informed

Selvarakeshkumar - Not Informed

Sridharan - Not Informed

Tharunya - Not Informed

 PRINCIPAL,
 K. S. R. INSTITUTE FOR
 ENGINEERING AND TECHNOLOGY,
 K. S. R. KALVINAGAR,
 TIRUCHENGODE-637 215,
 NAMAKKAL DT, TAMIL NADU.

K S R INSTITUTE FOR ENGINEERING AND TECHNOLOGY, Tiruchengode

Training and Placement Cell

Batch 3- Quantitative, Reasoning & Verbal Training Programme by Six Phrase

BATCH : 2015 - 2019

Sem: Odd

Hall: 109

Academic Year: 2018 - 2019

Date of Training Programme				28.08.18		29.08.18		30.08.18		31.08.18	
S. No	Reg No	Name	Branch	FN	AN	FN	AN	FN	AN	FN	AN
1	731615104005	BALAJI M	CSE	/	X	X	IP	u	au	/	X
2	731615104008	DINESH J	CSE	/	1a	P	P	P	P	u	a
3	731615104010	GOKUL K	CSE	/	1a	X	X	/	1	/	X
4	731615104014	JANANI A	CSE	/	X	X	X	/	X	/	X
5	731615104018	MEIYAPPAN M	CSE	.	.	X	ya	/	X	/	X
6	731615104027	PRASANTH R	CSE	/	X	X	1a	a	a	/	X
7	731615104036	SHALINI S	CSE	/	X	X	X	/	X	r	.
8	731615105005	CHIDAMBARAM V	EEE A	/	X	/	X	/	X	fo	.
9	731615105007	DHIVAGAR N	EEE A	/	X	X	X	/	X	/	X
10	731615105008	DHIVAGAR S	EEE A	/	X	X	X	/	X	/	X
11	731615105009	DICKMAN PIOUS P	EEE A	/	X	X	X	f	y.	/	X
12	731615105011	ELANCHEZHIAN P	EEE A	/	X	/	X	/	X	/	/
13	731615105012	GAYATHRI K	EEE A	/	LV	W	X	/	X	/	/
14	731615105013	GOBIKRISHNAN R	EEE A	/	X	X	X	d.	X	/	X
15	731615105016	GOKUL V	EEE A	/	X	X	X	/	X	/	/
16	731615105017	GOKULAKRISHNAN S	EEE A	/	X	X	X	OD	X	/	X
17	731615105021	GOWSALYA A	EEE A	/	X	/	X	/	X	/	X
18	731615105024	GOWTHAM V	EEE A	/	X	X	yp	/	/P	/	yp
19	731615105026	HARIHARAN G	EEE A	/	X	/	X	OD	X	/	X
20	731615105027	HARIHARAN N	EEE A	/	X	X	X	/	X	/	X
21	731615105029	HARINI S	EEE A	/	X	/	X	OD	X	/	X
22	731615105030	JANANI R	EEE A	/	X	X	X	/	X	/	X
23	731615105033	JEEVAPRAKASH V	EEE A	/	X	/	X	/	X	P	Pe
24	731615105034	KALAICHELVI V	EEE A	.	.	X	X	/	X	/	X
25	731615105035	KANNAN S	EEE A	/	X	X	X	/	X	/	X
26	731615105039	KEERTHIKA C	EEE A	/	X	X	X	/	X	/	X
27	731615105046	LOHESH J	EEE B	/	X	X	X	/	X	/	X
28	731615105052	MANOJ KUMAR R	EEE B	/	X	/	fo	/	X	/	X
29	731615105053	MOHAMMEDRIYAS A	EEE B	/	X	X	X	/	X	/	X
30	731615105055	MONISHA V	EEE B	/	X	X	X	/	X	/	yp
31	731615105056	MOUNISHA S	EEE B	/	X	X	X	/	X	/	X
32	731615105058	NAVEEN M T	EEE B	.	.	X	X	/	X	/	X
33	731615105059	NAVEEN KUMAR S	EEE B	/	X	/	X	/	X	/	X
34	731615105062	POOJA R	EEE B	/	X	/	X	/	X	/	X
35	731615105063	PRAVEENKUMAR B	EEE B	/	X	X	X	/	X	/	X
36	731615105064	PRAVEENKUMAR S	EEE B	/	X	X	X	/	X	/	X
37	731615105065	PRIYADHARSHINI S	EEE B	/	X	X	X	/	X	/	X

Date of Training Programme				28.08.18		29.08.18		30.08.18		31.08.18	
S. No	Reg No	Name	Branch	FN	AN	FN	AN	FN	AN	FN	AN
38	731615105066	RAJASEKAR P V	EEE B	/	X	X	X	/	X	/	X
39	731615105067	RAMESH S R	EEE B	/	X	X	X	/	X	/	X
40	731615105069	RANJITHKUMAR N	EEE B			X	X	/	X	/	X
41	731615105070	RAVI A	EEE B	/	X	/	X	/	X	A	A
42	731615105071	SATHISH KUMAR M	EEE B	/	X	/	X	/	X	/	X
43	731615105072	SEKAR S	EEE B	/	X	/	X	/	X	/	X
44	731615105078	SURENDHAR M M	EEE B	/	X	X	X	/	X	/	X
45	731615105079	SWATHI R	EEE B	/	X	X	X	/	X	/	X
46	731615105081	TAMILSELVAN M	EEE B	/	X	/	X	OD	X	/	X
47	731615105082	THARUN N	EEE B	/	X			/	X	A	A
48	731615105084	VEERA KUMAR B	EEE B	/	X	X	X	/	X	/	X
49	731615105085	VISHNU R	EEE B	/	X	/	X	/	X	/	X
50	731615105087	YOGESHWARAN S	EEE B			/	X	/	X	/	X
PRESENT											
ABSENT											
PERMISSION											

51 731615105036 Karthik C EEEA / X X X / X / X

Training Timing

Time:

09:00 - 11:00 - Session - I

11:15 - 12:45 - Session - II

01:45 - 03:00 - Session - III

03:10 - 04:30 - Session - IV

05:00 - 06:30 - Test & Discussion

Break:

11:00 - 11:15

12:45 - 01:45

3:00 - 3:10

41
35
51
127

Kirubhanandhan P CSE

Boopalhiraja M CSE

Sathivel E CSE

29/8 Evening	30/8 FN	30/8 AN	31/8 FN	31/8 AN
/	/	X	/	X
/	/	X	/	X
A	P	P	A	A

PRINCIPAL,
K. S. R. INSTITUTE FOR
ENGINEERING AND TECHNOLOGY,
K. S. R. KALVI NAGAR,
TIRUCHENGOORE - 637 215,
NAGAR ROAD, TIRUCHENGOORE.

Batch 1 Aptitude and Reasoning Training programme By Six Phrase

BATCH: 2015 - 2019

ACADEMIC YEAR: 2018 - 2019 (ODD)

DATE: 20.08.2018

Fore Noon session

S.NO	Branch	Strength	Present	Absent	Permission
1	CSE	10	10	0	0
2	ECE - A	6	6	0	0
3	ECE - B	5	5	0	0
4	EEE - A	3	3	0	0
5	EEE - B	7	7	0	0
6	IT	11	10	0	1
Total		42	41	0	1

After Noon session

S.NO	BRANCH	Strength	Present	Absent	OD
1	CSE	10	7	0	3
2	ECE - A	6	5	0	1
3	ECE - B	5	5	0	0
4	EEE - A	3	2	0	1
5	EEE - B	7	6	0	1
6	IT	11	6	0	5
Total		42	31	0	11

[Signature]
T&P OFFICER
20/8/18

[Signature]
T&P CO-ORDINATOR
20/8/18

[Signature]
PRINCIPAL
K. S. R. INSTITUTE FOR
ENGINEERING AND TECHNOLOGY,
K. S. R. KALVI NAGAR,
TIRUCHENGODE-637 215,
NAMAKKAL DISTRICT, TAMIL NADU.

TRAINING & PLACEMENT CELL



Batch 1 Aptitude and Reasoning Training Programme by Six Phrase

BATCH: 2015 - 2019

ACADEMIC YEAR: 2018 - 2019 (ODD)

DATE: 21.08.2018

Fore Noon session

S.NO	Branch	Strength	Present	Absent	Permaission
1	CSE	10	7	0	3
2	ECE - A	6	5	0	1
3	ECE - B	5	5	0	0
4	EEE - A	3	2	0	1
5	EEE - B	7	6	0	1
6	IT	11	6	0	5
Total		42	31	0	11

After Noon session

S.NO	BRANCH	Strength	Present	Absent	Leave
1	CSE	10	7	0	3
2	ECE - A	6	5	0	1
3	ECE - B	5	5	0	0
4	EEE - A	3	2	0	1
5	EEE - B	7	6	0	1
6	IT	11	6	0	5
Total		42	31	0	11

K. S. R. IET
T & P OFFICER
21/8/18

K. S. R. IET
T & P CO ORDINATOR

K. S. R. IET
PRINCIPAL
K. S. R. INSTITUTE
ENGINEERING AND TECHNOLOGY,
K. S. R. KALVI NAGAR,
TIRUCHENGODE-637 215,
NAMAKKAL DI, TAMIL NADU.

TRAINING & PLACEMENT CELL

KSRJET

Batch 1 Aptitude and Reasoning Training programme By Six Phrase

BATCH: 2015 - 2019

ACADEMIC YEAR: 2018 - 2019 (ODD)

DATE: 22.08.2018

Fore Noon session

S.NO	Branch	Strength	Present	Absent	Permission
1	CSE	10	7	0	3
2	ECE - A	6	5	0	1
3	ECE - B	5	5	0	0
4	EEE - A	3	2	0	1
5	EEE - B	7	6	0	1
6	IT	11	6	0	5
Total		42	31	0	11

After Noon session

S.NO	BRANCH	Strength	Present	Absent	Leave
1	CSE	10	7	0	3
2	ECE - A	6	5	0	1
3	ECE - B	5	5	0	0
4	EEE - A	3	2	0	1
5	EEE - B	7	6	0	1
6	IT	11	6	0	5
Total		42	31	0	11

[Signature]
T & P OFFICER

[Signature]
T&P CO ORDINATOR

PRINCIPAL
K. S. R. INSTITUTE FOR
ENGINEERING AND TECHNOLOGY,
K. S. R. KALVI NAGAR,
TIRUCHENGODE-637 215,
NAMAKKAL DI, TAMIL NADU



Batch 1 Aptitude and Reasoning Training programme By Six Phrase

BATCH: 2015 - 2019

ACADEMIC YEAR: 2018 - 2019 (ODD)

DATE: 28.08.2018

Fore Noon session

S.NO	Branch	Strength	Present	Absent	Permission
1	CSE	7	6	1	0
2	ECE - A	21	11	8	2
3	ECE - B	16	12	3	1
4	EEE - A	20	19	1	0
5	EEE - B	24	21	3	0
6	IT	7	4	0	3
Total		95	73	16	6

After Noon session

S.NO	BRANCH	Strength	Present	Absent	Leave
1	CSE	7	6	1	0
2	ECE - A	21	12	7	2
3	ECE - B	16	12	3	1
4	EEE - A	20	19	1	0
5	EEE - B	24	21	3	0
6	IT	7	4	0	3
Total		95	74	15	6

[Signature]
T & P OFFICER

[Signature]
T&P CO ORDINATOR

[Signature]
PRINCIPAL
K. S. R. INSTITUTE FOR
ENGINEERING AND TECHNOLOGY,
K. S. R. KALVI
TIRUCHENGODE
NAMAKKAL

[Signature]
PRINCIPAL

Batch 1 Aptitude and Reasoning Training programme By Six Phrase

BATCH: 2015 - 2019

ACADEMIC YEAR: 2018 - 2019 (ODD)

DATE: 29.08.2018

Fore Noon session

S.NO	Branch	Strength	Present	Absent	Permission
1	CSE	7	6	0	1
2	ECE - A	16	13	2	1
3	ECE - B	14	8	4	2
4	EEE - A	20	19	0	1
5	EEE - B	24	23	0	1
6	IT	7	5	1	1
Total		88	74	7	7

After Noon session

S.NO	BRANCH	Strength	Present	Absent	Leave
1	CSE	7	6	0	1
2	ECE - A	16	13	2	1
3	ECE - B	14	8	4	2
4	EEE - A	20	19	0	1
5	EEE - B	24	23	0	1
6	IT	7	5	1	1
Total		88	74	7	7

T & P OFFICER
29/8/18

T & P CO ORDINATOR
29/8/18

PRINCIPAL
29/8/18

PRINCIPAL
K. S. R. INSTITUTE FOR
ENGINEERING AND TECHNOLOGY
K. S. R. KALVI NAGAR,
TIRUCHENGODE-637 215,
NAMAKKAL Dt. TAMIL NADU.

Batch 1 Aptitude and Reasoning Training programme By Six Phrase

BATCH: 2015 - 2019

ACADEMIC YEAR: 2018 - 2019 (ODD)

DATE: 30.08.2018

Fore Noon session

S.NO	Branch	Strength	Present	Absent	Permission
1	CSE	7	4	2	1
2	ECE - A	16	13	3	0
3	ECE - B	14	11	3	0
4	EEE - A	20	17	0	3
5	EEE - B	24	23	0	1
6	IT	7	6	1	0
Total		88	74	9	5

After Noon session

S.NO	BRANCH	Strength	Present	Absent	Leave
1	CSE	7	6	0	1
2	ECE - A	16	13	2	1
3	ECE - B	14	8	4	2
4	EEE - A	20	19	0	1
5	EEE - B	24	23	0	1
6	IT	7	5	1	1
Total		88	74	7	7

T & P OFFICER

T&P CO ORDINATOR

PRINCIPAL

PRINCIPAL,
K. S. R. INSTITUTE FOR
ENGINEERING AND TECHNOLOGY,
K. S. R. KALVI NAGAR,
TIRUCHENGODE-637 215,
NAMAKKAL DI, TAMIL NADU.

Batch 1 Aptitude and Reasoning Training programme By Six Phrase

BATCH: 2015 - 2019

ACADEMIC YEAR: 2018 - 2019 (ODD)

DATE: 31.08.2018

Fore Noon session

S.NO	Branch	Strength	Present	Absent	OD
1	CSE	7	6	1	0
2	ECE - A	16	15	1	0
3	ECE - B	14	11	3	0
4	EEE - A	20	18	0	2
5	EEE - B	24	22	2	0
6	IT	7	5	2	0
Total		88	77	9	2

After Noon session

S.NO	BRANCH	Strength	Present	Absent	Leave
1	CSE	7	6	1	0
2	ECE - A	16	15	1	0
3	ECE - B	14	11	3	0
4	EEE - A	20	18	0	2
5	EEE - B	24	22	2	0
6	IT	7	5	2	0
Total		88	77	9	2

T & P OFFICER

T&P CO ORDINATOR

PRINCIPAL

PRINCIPAL,
K. S. R. INSTITUTE FOR
ENGINEERING AND TECHNOLOGY,
K. S. R. KALVI NAGAR,
TIRUCHENGODE-637 215,
NAMAKKAL Dt. TAMIL NADU.



Name of the Student: M. Sathish Kumar Branch: EEE

Year / Sem: Final year / 7th sem.

1. Name of the Training : Santhosh Reasoning

2. Name of the Trainer : Santhosh

3. Students rating of Trainers :

S. No.	Date	Subject	Rating (✓)			
			Excellent	Very good	Good	Average
1	28.8.18	Blood Relation		✓		

4. Two positive points about the programme:

* The program was very interesting and we learned more about Blood Relations. * It is very useful to us

5. Suggestions for improvement:

* We need ^{more} Aptitude Training
* We need more Examples and Explanation

Date: 28.8.18

Signature M. P. Sathish



Name of the Student: A. Mohammad Riyas Branch: EEE

Year / Sem: Final year / 7th sem.

4. Name of the Training : Quantitude Aptitude.

5. Name of the Trainer : Satheesh.

6. Students rating of Trainers :

S. No.	Date	Subject	Rating (✓)			
			Excellent	Very good	Good	Average
1	28/8/18	Ratio and Propagation.			✓	

4. Two positive points about the programme:

1. We learned logical problem solving it helps, time maintaining for solving questions.

5. Suggestions for improvement:

1. Need more explanation and Examples problems.

2. Weekly once conduct the aptitude class. S. P. Sathish

Date: 28/8/18.

Signature
K S R INSTITUTE FOR
ENGINEERING AND TECHNOLOGY,
K. S. R. KALVI NAGAR,
TIRUCHENGODE-637 215,
NAMAKKAL Dt. TAMIL NADU.



Name of the Student: M. Ezhil Branch: ECF

Year / Sem: IV / VIIth

1. Name of the Training: Sathishkumar

2. Name of the Trainer :

3. Students rating of Trainers :

S. No.	Date	Subject	Rating (√)			
			Excellent	Very good	Good	Average
1	28.8.2018	APtitude		✓		

4. Two positive points about the programme:

easy to understand

5. Suggestions for improvement:

To take for time discussion problems

Date: 28.8.2018

M/E
Signature



Name of the Student: M. Saranya Branch: ECF

Year / Sem: IV / VII

4. Name of the Training :

5. Name of the Trainer : Sathishkumar

6. Students rating of Trainers :

S. No.	Date	Subject	Rating (√)			
			Excellent	Very good	Good	Average
1	28/8/18	Aptitude		✓		

4. Two positive points about the programme:

Clever short cut

5. Suggestions for improvement:

Can provide time for individual discussion from the time

Date:

28/8/18

Signature
PRINCIPAL,
K. S. R. INSTITUTE FOR ENGINEERING AND TECHNOLOGY,
K. S. R. KALYANANAGAR,
TIRUCHENGODE - 637 215,
NAMARKKAL DI, TAMIL NADU.

K S R INSTITUTE FOR ENGINEERING AND TECHNOLOGY
TIRUCHENGODE - 637 215
TRAINING PROGRAMME FEEDBACK FORM



Name of the Student: Yogesh V

Branch: ECE - B

Year / Sem: IVth / VIIth

1. Name of the Training: APTITUDE TRAINING

2. Name of the Trainer: SATHESH KUMAR

3. Students rating of Trainers :

S. No.	Date	Subject	Rating (✓)			
			Excellent	Very good	Good	Average
1	28-08-18	Quantitative Aptitude	✓			

4. Two positive points about the programme:

We are knowing the new techniques in mathematics

5. Suggestions for improvement:

Date: 28-08-2018

V. Pr
Signature

K S R INSTITUTE FOR ENGINEERING AND TECHNOLOGY
TIRUCHENGODE - 637 215
TRAINING PROGRAMME FEEDBACK FORM



Name of the Student: C. Sridhar

Branch: ECE - B

Year / Sem: IVth / VIIth

4. Name of the Training: APTITUDE TRAINING

5. Name of the Trainer: SATHISH KUMAR

6. Students rating of Trainers :

S. No.	Date	Subject	Rating (✓)			
			Excellent	Very good	Good	Average
1	28.8.18	Quantitative aptitude	✓			

4. Two positive points about the programme:

It is very useful.

Suggestions for improvement:

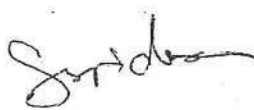

 PRINCIPAL, Signature
 K. S. R. INSTITUTE FOR
 ENGINEERING AND TECHNOLOGY,
 K. S. R. KALVI NAGAR,
 TIRUCHENGODE - 637 215,
 NAMAKKAL Dt, TAMIL NADU.



TRAINING PROGRAMME FEEDBACK FORM

Name of the Student: Ram Kumar L

Branch: B. E (ECE)

Year / Sem: V / VII

1. Name of the Training : Reasoning (Venn diagram), Directions, Angle
 2. Name of the Trainer : Sathish
 3. Students rating of Trainers :

S. No.	Date	Subject	Rating (✓)			
			Excellent	Very good	Good	Average
1	29/08/18	Venn diagram, Directions, Angle		✓		

4. Two positive points about the programme:

- Good communication with students and
then subject wise is excellent in the content
 5. Suggestions for improvement: subject

Date: 29/08/18

[Signature]
Signature



TRAINING PROGRAMME FEEDBACK FORM

Name of the Student: N. Nareesh

Branch: B. E (ECE)

Year / Sem: V / VII

4. Name of the Training : Reasoning (Venn diagram), Directions, Angle, Calendar
 5. Name of the Trainer : Sathish
 6. Students rating of Trainers :

S. No.	Date	Subject	Rating (✓)			
			Excellent	Very good	Good	Average
1	29/08/18	Venn diagram, Directions, Angle		✓		

4. Two positive points about the programme:

- Good Communi, Content

5. Suggestions for improvement:

Date:

29/08/18

PRINCIPAL
K. S. R. INSTITUTE FOR
ENGINEERING AND TECHNOLOGY
K. S. R. KALVI NAGAR,
TIRUCHENGODE 637 215,
TAMIL NADU.

[Signature]
Signature

Name of the Student: S. YOGESHWARAN Branch: EEEYear / Sem: IVth / VIIth sem1. Name of the Training: APTITUDE2. Name of the Trainer: SATHISH KUMAR

3. Students rating of Trainers :

S. No.	Date	Subject	Rating (✓)			
			Excellent	Very good	Good	Average
1	29.8.18	APTITUDE		✓		

4. Two positive points about the programme: Clear Explanation in all Topics and Many Shortcuts were taught5. Suggestions for improvement: More Problems can be discussed There is No InteractionDate: 29.8.18

Signature
Name of the Student: M.T. NAVEEN Branch: EEEYear / Sem: V / VI4. Name of the Training: REASONING5. Name of the Trainer: SANTHOSH

6. Students rating of Trainers :

S. No.	Date	Subject	Rating (✓)			
			Excellent	Very good	Good	Average
1	29.8.2018	REASONING	✓			

4. Two positive points about the programme: Good relationship with us. Perfect explanation about the subject and including many general information.5. Suggestions for improvement: Give some more problems on the session.Date: 29.8.2018

Signature

PRINCIPAL,
K. S. R. INSTITUTE FOR
ENGINEERING AND TECHNOLOGY,
K. S. R. KALVI NAGAR,
TIRUCHENGODE - 637 215,
NAMAKKAL DI, TAMIL NADU.



Name of the Student: P. Pavithra

Branch: ECE

Year / Sem: V - 7th

1. Name of the Training: Aptitude.

2. Name of the Trainer: Sathish Kumar

3. Students rating of Trainers: 7

S. No.	Date	Subject	Rating (√)			
			Excellent	Very good	Good	Average
1	20.8.2018	Aptitude training	✓			

4. Two positive points about the programme:

Explaining the concepts very well
Explain doubts clearly

5. Suggestions for improvement:

No suggestions

Date: 20.8.2018

[Signature]
Signature



Name of the Student: A. Maheswari

Branch: EEE

Year / Sem: IV - 7th

4. Name of the Training: Aptitude

5. Name of the Trainer: Sathish Kumar

6. Students rating of Trainers: 9

S. No.	Date	Subject	Rating (√)			
			Excellent	Very good	Good	Average
1	20.8.2018	Aptitude training	✓			

4. Two positive points about the programme:

Explain with concept is very well.

5. Suggestions for improvement:

No suggestions.

Date: 20.8.2018

[Signature]

A. Maheswari
Signature

PRINCIPAL,
K. S. R. INSTITUTE FOR
ENGINEERING AND TECHNOLOGY,
R. S. B. KALVI NAGAR,
TIRUCHENGODE-637 215,
NAMAKKAL DISTRICT, TAMIL NADU.



Name of the Student: T. Guwabharathi

Branch: CSE-IV

Year / Sem: IV / VII

- 1. Name of the Training : aptitude
- 2. Name of the Trainer : Sathish Kumar
- 3. Students rating of Trainers : 8

S. No.	Date	Subject	Rating (√)			
			Excellent	Very good	Good	Average
1	20.8.18	Numbers problem.	✓			

4. Two positive points about the programme:

I learn more I get some ideas about Numbers problem. and learn new shortcuts about Numbers problem

5. Suggestions for improvement:

NO

Date: 20.8.18

T. Gu
Signature



Name of the Student: R. Saravani Priya

Branch: IT

Year / Sem: Final / VII

- 4. Name of the Training : Aptitude
- 5. Name of the Trainer : Sathish Kumar
- 6. Students rating of Trainers : 7.5

S. No.	Date	Subject	Rating (√)			
			Excellent	Very good	Good	Average
1	20.08.18	Ratio, Alloys and mixtures, Ages, Proportion	✓			

4. Two positive points about the programme:

→ Training is clearly understandable
→ I learn more.

5. Suggestions for improvement:

No issue

Date: 20.08.18

PRINCIPAL,
K. S. R. INSTITUTE FOR
ENGINEERING AND TECHNOLOGY,
K. S. R. KALVI NAGAR,
TIRUCHENGODE-637 215,
NAMAKKAL Dt, TAMIL NADU.

R. Saravani Priya
Signature



Name of the Student: R. Aiswarya Branch: IT

Year / Sem: 7th IV

1. Name of the Training: Reasoning

2. Name of the Trainer: Santhosh

3. Students rating of Trainers: 9/10

S. No.	Date	Subject	Rating (✓)			
			Excellent	Very good	Good	Average
1	21.8.2018	Reasoning	✓			

4. Two positive points about the programme: Interactive, Easy explanation of concepts, Blood Relation

5. Suggestions for improvement: used some real examples
time

R. Aiswarya

Date: 21.08.18

Signature



Name of the Student: S. Jayabharathi Branch: ECE

Year / Sem: IV / 7th Sem

4. Name of the Training: Reasoning

5. Name of the Trainer: Santhosh

6. Students rating of Trainers: 9/10

S. No.	Date	Subject	Rating (✓)			
			Excellent	Very good	Good	Average
1	21/8/18	Reasoning	✓			

4. Two positive points about the programme:

We are very interactive in Direction sense, Venn Diagram, Dice
Cube, Cuboid.

5. Suggestions for improvement:

PRINCIPAL
K. S. R. INSTITUTE FOR
ENGINEERING AND TECHNOLOGY,
K. S. R. KALVI NAGAR,
TIRUCHENGODE-637 215,
NAMAKKAL DI, TAMIL NADU.

Date: 21/8/18

S. Jayabharathi
Signature



Name of the Student: ARUN KUMAR R

Branch: B.Tech (I.T)

Year / Sem: IV / 7

1. Name of the Training: Appitude

2. Name of the Trainer: Satish

3. Students rating of Trainers :

S. No.	Date	Subject	Rating (✓)			
			Excellent	Very good	Good	Average
1	22-8-2018	Appitude	✓			

4. Two positive points about the programme:

Logic is clear with shortcuts, well Intalating.

5. Suggestions for improvement:

One more day for our improvement

Date:

Arun Kumar R
Signature



Name of the Student: M. MURUGANATH

Branch: EEE

Year / Sem: IV / VII

4. Name of the Training: Appitude

5. Name of the Trainer: Satish

6. Students rating of Trainers :

S. No.	Date	Subject	Rating (✓)			
			Excellent	Very good	Good	Average
1	22/08/18	Appitude		✓		

Simple Interest and compound interest; Percentages

4. Two positive points about the programme:

* Teaching to many shortcuts for solving problems
* good explanation.

5. Suggestions for improvement:

* Time not for we need extra teaching hours

Date: 22/08/2018

PRINCIPAL,
K. S. R. INSTITUTE FOR
ENGINEERING AND TECHNOLOGY
K. S. R. KALVI NAGAR,
TIRUCHENGODE - 637 215
NAMAKKAL DISTRICT, TAMIL NADU
M. M. Muruganath
Signature



Name of the Student: Mr. Vinodhini

Branch: ECE

Year / Sem: Final year / VII sem

1. Name of the Training: Aptitude Training

2. Name of the Trainer: M. Sathish

3. Students rating of Trainers :

S. No.	Date	Subject	Rating (√)			
			Excellent	Very good	Good	Average
1	22. 8. 2018	Aptitude	✓			

Simple, compound interest, percentage, profit and loss

4. Two positive points about the programme:

*1) Explaining doubts very clear

*1) Explaining all the problems in that topic

5. Suggestions for improvement:

clock
so it easy to understand,

no suggestions

Date: 22. 8. 2018

Signature

[Signature]



Name of the Student: M. C. Manohararaj

Branch: ECE

Year / Sem: Final year / VII sem

4. Name of the Training: Aptitude Training

5. Name of the Trainer: M. Sathish

6. Students rating of Trainers :

S. No.	Date	Subject	Rating (√)			
			Excellent	Very good	Good	Average
1	22. 8. 2018	Aptitude	✓			

Simple and compound interest

4. Two positive points about the programme:

* Explanation very well

5. Suggestions for improvement:

No suggestions

Date: 22. 8. 2018

PRINCIPAL
K. S. R. INSTITUTE FOR
ENGINEERING AND TECHNOLOGY,
K. S. R. KALVI NAGAR,
TIRUCHENGODE-637 215,
NAMAKKAL DI. TAMIL NADU.

Signature

[Signature]



Batch 1 Aptitude and Reasoning Training programme By Six Phrase

BATCH: 2015 - 2019

ACADEMIC YEAR: 2018 - 2019 (ODD)

DATE: 23.08.2018

Fore Noon session

S.NO	Branch	Strength	Present	Absent	Permission
1	CSE	10	7	0	3
2	ECE - A	6	5	0	1
3	ECE - B	5	5	0	0
4	EEE - A	3	2	0	1
5	EEE - B	7	6	0	1
6	IT	11	5	0	6
Total		42	30	0	12

After Noon session

S.NO	BRANCH	Strength	Present	Absent	Leave
1	CSE	10	7	0	3
2	ECE - A	6	5	0	1
3	ECE - B	5	5	0	0
4	EEE - A	3	2	0	1
5	EEE - B	7	6	0	1
6	IT	11	5	0	6
Total		42	30	0	12

[Signature]
T & P OFFICER

[Signature]
T&P CO ORDINATOR

[Signature]
PRINCIPAL
K. S. R. INSTITUTE FOR
ENGINEERING AND TECHNOLOGY
K. S. R. KALVI NAGAR,
TIRUCHENGODE - 637 215,
NAMAKKAL Dt. TAMIL NADU.



Name of the Student: S. Nisha Branch: CSE

Year / Sem: IV / VI

1. Name of the Training : Reasoning Aptitude

2. Name of the Trainer : Santhosh

3. Students rating of Trainers :

S. No.	Date	Subject	Rating (√)			
			Excellent	Very good	Good	Average
1	23/8/2018	Reasoning	✓			

4. Two positive points about the programme:

Explanation is clear, step by step explanation.

5. Suggestions for improvement:

NO

Date: 23/8/18

S. Nisha
Signature



Name of the Student: M. Elankanni Branch: IT

Year / Sem: IV / VII

4. Name of the Training : REASONING

5. Name of the Trainer : Santhosh

6. Students rating of Trainers :

S. No.	Date	Subject	Rating (√)			
			Excellent	Very good	Good	Average
1	23.8.18	<u>Arithmetic reasoning pie, bar chart symbols.</u>	✓			

4. Two positive points about the programme:

Good problem solving and concepts are explained good.

5. Suggestions for improvement: NO

Date: 23.8.18

M. Elankanni
Signature
PRINCIPAL.
K. S. R. INSTITUTE FOR
ENGINEERING AND TECHNOLOGY
K. S. R. KALVI NAGAR,
TIRUCHENGODE-637 215,
NAMANGAL Dt. TAMIL NADU.



Batch 1 Aptitude and Reasoning Training programme By Six Phrase

BATCH: 2015 - 2019

ACADEMIC YEAR: 2018 - 2019 (ODD)

DATE: 24.08.2018

Fore Noon session

S.NO	Branch	Strength	Present	Absent	Permission
1	CSE	10	7	0	3
2	ECE - A	6	5	0	1
3	ECE - B	5	5	0	0
4	EEE - A	3	2	0	1
5	EEE - B	7	6	0	1
6	IT	11	6	0	5
Total		42	31	0	11

After Noon session

S.NO	BRANCH	Strength	Present	Absent	Leave
1	CSE	10	7	0	3
2	ECE - A	6	5	0	1
3	ECE - B	5	5	0	0
4	EEE - A	3	2	0	1
5	EEE - B	7	6	0	1
6	IT	11	6	0	5
Total		42	31	0	11

K. S. R. Kalvi
T & P OFFICER
24/8/18

[Signature]
T&P CO ORDINATOR

[Signature]
PRINCIPAL

K. S. R. INSTITUTE FOR
ENGINEERING AND TECHNOLOGY,
K. S. R. KALVI NAGAR,
TIRUCHENGODE-637 215,
NAMAKKAL DG, TAMIL NADU.



Name of the Student: S. Anishharaman Branch: 24/8/18 (EEE)

Year / Sem: IV x 7th

1. Name of the Training : Aptitude
 2. Name of the Trainer : S. Sathish
 3. Students rating of Trainers :

S. No.	Date	Subject	Rating (✓)			
			Excellent	Very good	Good	Average
1	24/8/18	Aptitude		✓		

4. Two positive points about the programme:

- * good
- * usefull for exam

5. Suggestions for improvement:

Date: 24/8/18

[Signature]
Signature



Name of the Student: C. MohanRaj Branch: CSE

Year / Sem: IV / VI

4. Name of the Training : Sathish Aptitude
 5. Name of the Trainer : S. Sathish
 6. Students rating of Trainers :

S. No.	Date	Subject	Rating (✓)			
			Excellent	Very good	Good	Average
1	24/8/18	Aptitude Time and work		✓		

4. Two positive points about the programme:

- * Easy to learn

5. Suggestions for improvement:

- * very useful

Date: 24.8.18.

PRINCIPAL.
K. S. R. INSTITUTE FOR
ENGINEERING AND TECHNOLOGY
K. S. R. KALVI NAGAR,
TIRUCHENGODE-637 215,
NAMAKKAL Dt., TAMIL NADU.
[Signature]
Signature



Name of the Student: T. Harini Branch: ECE

Year / Sem: IV / 7

1. Name of the Training : Reasoning
 2. Name of the Trainer : Santhosh.
 3. Students rating of Trainers :

S. No.	Date	Subject	Rating (✓)			
			Excellent	Very good	Good	Average
1	29/8/18	Direction	✓			

4. Two positive points about the programme:

It is very usefull, and ~~and~~ discuss practical problem

5. Suggestions for improvement:

nothing

thinking about ~~base~~ ways of looking at it differently.

Date:

29/8/18

Signature

T. Harini



Name of the Student: D. Bharathi Branch: ECE

Year / Sem: IV / 7

4. Name of the Training : Reasoning
 5. Name of the Trainer : Santhosh

6. Students rating of Trainers :

S. No.	Date	Subject	Rating (✓)			
			Excellent	Very good	Good	Average
1	29/8/18	Direction		✓		

4. Two positive points about the programme:

It is very interesting to be attent

5. Suggestions for improvement:

NO

Date:

29/8/18

PRINCIPAL,
 K. S. R. INSTITUTE FOR
 ENGINEERING AND TECHNOLOGY,
 K. S. R. KALVI NAGAR,
 TIRUCHENGODE-637 215,
 NARASIPPALETTUR, TAMIL NADU.

Signature,
D. Bharathi



Name of the Student: A. Janani Branch: CSE

Year / Sem: IV / VII

1. Name of the Training: Quantitative Aptitude

2. Name of the Trainer: Sathish

3. Students rating of Trainers :

S. No.	Date	Subject	Rating (✓)			
			Excellent	Very good	Good	Average
1	31.08.18	Compound Interest, Simple Interest, Time & work.			✓	

4. Two positive points about the programme:
* Knows what is aptitude and how to solve easily.

* Knows how company asks questions.

5. Suggestions for improvement:

* Increasing time for teaching.

A. Janani
Signature

Date: 31.08.18



Name of the Student: KIRUBHANANDHAN.P Branch: B.E - CSE

Year / Sem: IV - VII

4. Name of the Training: APTITUDE & REASONING

5. Name of the Trainer: SANTHOSH

6. Students rating of Trainers : 7/10

S. No.	Date	Subject	Rating (✓)			
			Excellent	Very good	Good	Average
1	31.08.18	DATA INTERPRETATION DATA SUFFICIENCY			✓	

4. Two positive points about the programme:
* We can save time while using shortcuts instead of calc.

5. Suggestions for improvement:

* By Practising

P. Deebakrishnan
PRINCIPAL Signature

Date: 31.08.18



Training Schedule [2018 - 2019] Odd Semester

Ref: KSRIET/T&P/CIR/2018-19

Date: 31.08.2018

This is to inform that all the HoD's, Faculty and CSE, ECE, EEE & IT Department Training and Placement coordinator that the 4 Days Company Specific (Wipro) External Training Programme for IV Year Students for the academic year 2018 - 2019 (Odd Sem) by Six Phase has been scheduled. All the registered students should attend the Training Programme without fail. If any student skips this Training Programme without proper permission from the respective HoDs, he / she will not be permitted for any further Training Programme and campus recruitment process. Proper Dress Code is mandatory.

S.No	Date(s)	Department(Strength)
1	04.09.2018 To 07.09.2018	CSE - 17, ECE A - 22, ECE B - 18, EEE A- 23, EEE B - 31 & IT - 16 Total- 127

T&P OFFICER

T&P COORDINATOR

PRINCIPAL

Copy to:

1. All HoDs
2. Notice Board

Session Timings:

Forenoon Session: 09.00 am to 12.30 pm Break: 10.45 am to 11.00 am & 03.00 pm to 03.10 pm

Afternoon Session: 01.30 pm to 04.30 pm Lunch: 12.30 pm to 01.30 pm

Evening Assessment & Discussion: 05:00pm to 07:00 pm

PRINCIPAL
K. S. R INSTITUTE FOR
ENGINEERING AND TECHNOLOGY,
K. S. R. KALVI NAGAR,
TIRUCHENGODE-637 215,
NAMAKKAL DI. TAMIL NADU.

Date of Training Programme				04.09.18		05.09.18		06.09.18		07.09.18	
S. No	Reg No	Name	Branch	FN	AN	FN	AN	FN	AN	FN	AN
1	731615205011	DENMOZHLS	IT	P	P	P	P	P	P	P	P
2	731615205018	ELANGOVAN.S	IT	ab	ab	P	P	P	ab	ab	ab
3	731615205021	GOWSIKKANNAN.V	IT	P	P	P	P	P	P	P	P
4	731615205026	MANOJKUMAR.D	IT	P	P	P	P	P	P	P	P
5	731615205029	PRIYANKA.S	IT	P	P	P	P	P	P	P	P
6	731615205031	RAMESH.A	IT	P	P	P	P	P	ab	ab	ab
7	731615106001	ALEXRAJ.A	ECE A	P	P	P	P	P	P	ab	ab
8	731615106006	BHARATHI.D	ECE A	P	P	P	P	P	ab	ab	ab
9	731615106012	DEVI.U	ECE A	P	P	P	P	P	P	P	P
10	731615106013	DHARANLR	ECE A	P	P	P	P	P	P	P	P
11	731615106014	DHAYALIG	ECE A	P	P	P	P	P	P	P	P
12	731615106016	DIVYA.S	ECE A	P	P	P	P	P	ab	P	P
13	731615106017	DIVYA.S	ECE A	P	P	P	P	P	P	P	P
14	731615106018	EZHILM	ECE A	P	P	P	P	P	P	P	P
15	731615106020	GAYATHRI.R	ECE A	P	P	P	P	P	P	P	P
16	731615106025	HARINI.T	ECE A	P	P	P	P	P	P	P	P
17	731615106027	HEMALATHA.T	ECE A	P	P	P	P	ab	ab	P	P
18	731615106032	KARTHIKA.D	ECE A	P	P	P	P	ab	ab	P	P
19	731615106034	KARTHIKEYAN.S	ECE A	P	P	P	P	ab	ab	P	P
20	731615106037	KEERTHANAL	ECE A	P	P	P	P	P	P	P	P
21	731615106302	PRATHEEP S	ECE A	P	P	P	P	P	P	ab	ab
22	731615106303	RAMKUMAR L	ECE A	P	P	ab	ab	ab	ab	P	P
23	731615106042	LOGAPRIYA.M	ECE B	P	P	P	P	P	P	P	P
24	731615106045	NARESH.N	ECE B	P	P	P	P	P	P	P	P
25	731615106052	PALANIVELU G	ECE B	P	P	P	P	P	P	P	P
26	731615106059	PRIYADHARSHINLS	ECE B	P	P	P	P	P	P	P	P
27	731615106064	RANJITH RAJA M	ECE B	P	P	P	P	P	P	P	P
28	731615106066	SARANYA.M	ECE B	P	P	P	P	P	P	P	P
29	731615106067	SARASWATHI P	ECE B	P	P	P	P	P	P	P	P
30	731615106069	SELVARAKESHKUMAR C	ECE B	P	P	P	P	ab	ab	ab	ab

PRINCIPAL,
K. S. R. INSTITUTE FOR
ENGINEERING AND TECHNOLOGY,
K. S. R. KALVI NAGAR,
TIRUCHENGODE-637 215,
NAMAKKAL DI, TAMIL NADU.

Date of Training Programme				04.09.18		05.09.18		06.09.18		07.09.18	
S. No	Reg No	Name	Branch	FN	AN	FN	AN	FN	AN	FN	AN
31	731615105057	MURUGANANTH M	EEE B	Y	X	/	/	Pe	/	/	/
32	731615205006	ARUNKUMAR.R	IT	X	X	/	/	/	/	+	-
33	731615205040	THIRUMALAIRAJAN.K	IT	X	X	/	/	/	/	-	-
34	731615205023	HEMALATHA.G	IT	X	X	/	/	/	/	-	-
35	731615205002	AISWARYA.R	IT	X	X	/	/	/	/	-	-
36	731615205014	DHARANI.P	IT	X	X	/	/	/	/	/	/
37	731615205036	SARAVANAPRIYA R	IT	ay	X	/	/	/	/	/	/
38	731615205038	SNEKA D	IT	X	X	/	/	/	/	/	/
39	731615205012	DHANUSYADEVIS	IT	ay	X	/	/	/	/	/	/
40	731615205019	ELANKANEI.M	IT	ay	X	/	/	/	/	+	-
41	731615205022	GOWTHAM.R	IT	X	X	/	/	/	/	-	-
PRESENT				39	40						
ABSENT				03	02						

42.

Priyadarsini.S

ECE

X ✓
8/8



PRINCIPAL,
K. S. R. INSTITUTE FOR
ENGINEERING AND TECHNOLOGY,
K. S. R. KALVI NAGAR,
TIRUCHENGODE-637 215,
NAMAKKAL Dt. TAMIL NAGU.

Timing : 9 to 10.45
 Break: 10.45 to 11.00
 11.00 to 12.30
 Lunch 12.30 to 1.30
 1.30 to 3.00
 break 3.00 to 3.10
 3.10 to 4.40
 break 4.40 to 5.10
 5.10 to 6.45

Date of Training Programme				04.09.18		05.09.18		06.09.18		07.09.18	
S.No	Reg No	Name	Branch	FN	AN	FN	AN	FN	AN	FN	AN
1	731615104009	ELAKKIYA T.E	CSE	Pe	Pe	Pe	Pe	Pe	Pe	Pe	—
2	731615104012	GUNA BHARATHI T	CSE	X	x	/	/	/	/	/	/
3	731615104023	NISHA S	CSE	X	x	/	/	/	/	/	/
4	731615104033	SAKTHIVEL E	CSE	X	x	/	/	/	/	/	/
5	731615104007	BOOPATHIRAJA M	CSE	x	x	/	/	/	/	/	/
6	731615104016	KIRUBHANANDHAN P	CSE	X	x	/	/	/	/	/	/
7	731615104019	MOHANRAJ C	CSE	X	X	/	/	/	/	/	/
8	731615104044	VINOTHA V	CSE	X	x	/	/	/	/	/	/
9	731615104030	PRIYADHARSHINI R	CSE	x	x	/	/	/	/	P	P
10	731615104029	PRAVEEN G	CSE	X	x	/	/	/	/	/	/
11	731615106015	DHIVYA.M	ECE A	x	x	/	/	/	/	/	/
12	731615106029	JAYABHARATHI S	ECE A	X	x	/	/	/	/	/	/
13	731615106036	KAVIPREETHI V	ECE A	X	x	/	/	/	/	/	/
14	731615106009	BHUVANESWARI R	ECE A	X	X	/	/	/	/	/	/
15	731615106024	GOWRI P	ECE A	X	x	/	/	/	/	/	/
16	731615106041	KOWSALYA C	ECE A	X	x	/	/	/	/	/	/
17	731615106054	PAVITHRA P	ECE B	X	x	/	/	/	/	/	/
18	731615106073	SUGANTHI S	ECE B	X	x	/	/	/	/	/	/
19	731615106077	UMA MAHESHWARI M	ECE B	X	x	/	/	/	/	/	/
20	731615106079	VINOTHINI G	ECE B	X	X	/	/	/	/	/	/
21	731615106074	TAMILARASI J	ECE B	X	X	/	/	/	/	/	/
22	731615105044	KRISHNAMOORTHY S	EEE A	X	x	/	/	/	/	/	/
23	731615105002	ARUNKUMAR C	EEE A	Pe	Pe	Pe	Pe	Pe	Pe	Pe	—
24	731615105023	GOWTHAM S	EEE A	X	x	/	/	/	/	/	/
25	731615105049	MAHAESHWARI A	EEE B	X	x	/	/	/	/	/	/
26	731615105073	SOUNDHARYA S	EEE B	X	x	/	/	/	/	/	/
27	731615105075	SRINITHI G	EEE B	X	x	/	/	/	/	/	/
28	731615105086	YOGAPRIYA S	EEE B	X	x	/	/	/	/	/	/
29	731615105076	SRINIVASAN R	EEE B	X	x	/	/	/	/	/	/
30	731615105077	STEPHEN IMMANUVEL J	EEE B	X	x	/	/	/	/	/	/

PRINCIPAL
**K. S. R. INSTITUTE FOR
ENGINEERING AND TECHNOLOGY,
K. S. R. KALVI NAGAR,
TIRUCHENGODE-637 215,
NAMAKKAL Dt, TAMIL NADU.**

Date of Training Programme				04.09.18		05.09.18		06.09.18		07.09.18	
S. No	Reg No	Name	Branch	FN	AN	FN	AN	FN	AN	FN	AN
31	731615105064	PRAVEENKUMAR S	EEE B	/	/	/	/	/	/	/	/
32	731615105065	PRIYADHARSHINI S	EEE B	/	/	/	/	/	/	/	/
33	731615105066	RAJASEKAR P V	EEE B	/	/	/	/	/	/	/	/
34	731615105067	RAMESH S R	EEE B	/	/	/	/	/	/	/	/
35	731615105069	RANJITHKUMAR N	EEE B	/	/	/	/	/	/	/	/
36	731615105070	RAVI A	EEE B	/	/	/	/	/	/	/	/
37	731615105071	SATHISH KUMAR M	EEE B	/	/	/	/	/	/	/	/
38	731615105072	SEKAR S	EEE B	/	/	/	/	/	/	/	/
39	731615105078	SURENDHAR M M	EEE B	/	/	/	/	/	/	/	/
40	731615105082	THARUN N	EEE B	/	/	/	/	/	/	/	/
41	731615105084	VEERA KUMAR B	EEE B	/	/	/	/	/	/	/	/
42	731615105085	VISHNU R	EEE B	/	/	/	/	/	/	a	a
PRESENT											
ABSENT											

PRINCIPAL,
K. S. R. INSTITUTE FOR
ENGINEERING AND TECHNOLOGY,
K. S. R. KALVI NAGAR,
TIRUCHENGODE-637 215,
NAMAKKAL Dt. TAMIL NADU.

BATCH : 2015 - 2019

Sem: Odd

Hall: 109

Academic Year: 2018 - 2019

Date of Training Programme				04.09.18		05.09.18		06.09.18		07.09.18	
S. No	Reg No	Name	Branch	FN	AN	FN	AN	FN	AN	FN	AN
1	731615104005	BALAJI M	CSE	/	/	/	/	/	/	/	/
2	731615104008	DINESH J	CSE	/	/	/	/	/	/	/	/
3	731615104010	GOKUL K	CSE	/	/	/	/	/	/	/	/
4	731615104014	JANANI A	CSE	/	/	/	/	/	/	/	/
5	731615104018	MEIYAPPAN M	CSE	/	/	/	/	/	/	/	/
6	731615104027	PRASANTH R	CSE	/	/	/	/	/	/	/	/
7	731615104036	SHALINI S	CSE	/	/	/	/	/	/	/	/
8	731615105005	CHIDAMBARAM V	EEE A	/	/	/	/	/	/	/	/
9	731615105007	DHIVAGAR N	EEE A	/	/	/	/	/	/	/	/
10	731615105008	DHIVAGAR S	EEE A	/	/	/	/	/	/	/	/
11	731615105009	DICKMAN PIOUS P	EEE A	/	/	/	/	/	/	/	/
12	731615105011	ELANCHEZHIAN P	EEE A	/	/	/	/	/	/	/	/
13	731615105013	GOBIKRISHNAN R	EEE A	/	/	/	/	/	/	/	/
14	731615105016	GOKUL V	EEE A	/	/	X	/	/	/	/	/
15	731615105021	GOWSALYA A	EEE A	/	/	/	/	/	/	/	/
16	731615105024	GOWTHAM V	EEE A	/	/	/	/	/	/	/	/
17	731615105027	HARIHARAN N	EEE A	/	/	/	/	/	/	/	/
18	731615105033	JEEVAPRAKASH V	EEE A	/	/	/	/	/	/	/	/
19	731615105034	KALAICHELVI V	EEE A	/	/	/	/	/	/	/	/
20	731615105035	KANNAN S	EEE A	/	/	/	/	/	/	/	/
21	731615105039	KEERTHIKA C	EEE A	/	/	/	/	/	/	/	/
22	731615105036	KARTHIK C	EEE A	/	/	/	/	/	/	a	a
23	731615105046	LOHESH J	EEE B	/	/	/	/	/	/	/	/
24	731615105052	MANOJ KUMAR R	EEE B	/	/	/	/	/	/	/	/
25	731615105053	MOHAMMEDRIYAS A	EEE B	/	/	/	/	/	/	/	/
26	731615105055	MONISHA V	EEE B	a	a	/	/	/	/	/	/
27	731615105056	MOUNISHA S	EEE B	/	/	/	/	/	/	P	P
28	731615105058	NAVEEN M T	EEE B	/	/	/	/	/	/	/	/
29	731615105062	POOJA R	EEE B	/	/	/	/	/	/	/	/
30	731615105063	PRAVEENKUMAR B	EEE B	/	/	/	/	P	P	/	/

PRINCIPAL.
K. S. R. INSTITUTE FOR
ENGINEERING AND TECHNOLOGY,
K. S. R. KALVINAGAR,
TIRUCHENGODE-637 215,
TAMIL NADU.

Date of Training Programme				04.09.18		05.09.18		06.09.18		07.09.18	
S. No	Reg No	Name	Branch	FN	AN	FN	AN	FN	AN	FN	AN
31	731615106071	SRIDHAR C	ECE B	P	P	P	P	P	P	P	P
32	731615106072	SRIDHARAN.S	ECE B	P	P	P	P	P	P	P	P
33	731615106076	THARUNYA.S	ECE B	P	P	P	P	P	P	P	P
34	731615106078	VINAY.V	ECE B	P	P	P	P	P	P	P	P
35	731615106082	YOGESH E V	ECE B	P	P	P	P	P	P	P	P
36	731615105012	GAYATHRI K	EEE A	P	P	P	P	P	P	P	P
37	731615105017	GOKULAKRISHNAN S	EEE A	P	P	P	P	ab	ab	P	P
38	731615105026	HARIHARAN G	EEE A	P	P	P	P	P	P	P	P
39	731615105029	HARINI S	EEE A	P	P	P	P	ab	ab	P	P
40	731615105030	JANANI R	EEE A	P	P	P	P	P	P	P	P
41	731615105059	NAVEEN KUMAR S	EEE B	P	P	P	P	P	P	P	P
42	731615105079	SWATHI R	EEE B	P	P	P	P	P	P	P	P
43	731615105081	TAMILSELVAN M	EEE B	P	P	P	P	P	P	P	P
44	731615105087	YOGESHWARAN S	EEE B	P	P	ab	ab	P	P	P	P
45	731615205023	HEMALATHA.G	IT	P	P	P	P	P	P	P	P
46	731615205002	AISWARYA.R	IT	P	P	P	P	P	ab	ab	ab
47	731615205016	DIVYA.R	IT	P	P	P	P	P	P	P	P
48	731615205035	RINESH.R	IT	P	P	P	P	P	P	P	P
49	731615106057	PRAVEEN KUMAR V	ECE B	P	P	P	P	P	P	P	P
PRESENT				47	47	46	46	41	36	36	36
ABSENT				1	1	2	2	7	11	6	6

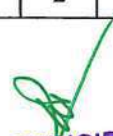
PRINCIPAL.
K. S. R. INSTITUTE FOR
ENGINEERING AND TECHNOLOGY,
K. S. R. KALVI NAGAR,
TIRUCHENGODE-637 215,
NAMAKKAL Dt. TAMIL NADU.

Training programme for Wipo By Six Phrase

BATCH: 2015 - 2019

ACADEMIC YEAR: 2018 - 2019 (ODD)

DATE: 04.09.2018

Fore Noon session

S.NO	Branch	Strength	Present	Absent	Permission
1	CSE	17	16	0	1
2	ECE - A	22	22	0	0
3	ECE - B	18	18	0	0
4	EEE - A	23	22	1	0
5	EEE - B	31	30	1	0
6	IT	16	15	1	0
Total		127	123	3	1

After Noon session

S.NO	BRANCH	Strength	Present	Absent	Leave
1	CSE	17	16	0	1
2	ECE - A	22	22	0	0
3	ECE - B	18	18	0	0
4	EEE - A	23	22	1	0
5	EEE - B	31	30	1	0
6	IT	16	15	1	0
Total		127	123	3	1

[Signature]
T & P OFFICER

[Signature]
T & P CO ORDINATOR

[Signature]
PRINCIPAL

PRINCIPAL.
K. S. R. INSTITUTE FOR
ENGINEERING AND TECHNOLOGY,
K. S. R. KALVI NAGAR,
TIRUCHENGODE-637 215,
NAMAKKAL Dt. TAMIL NAJU.



Training programme for Wipo By Six Phrase

BATCH: 2015 - 2019

ACADEMIC YEAR: 2018 - 2019 (ODD)

DATE: 05.09.2018

Fore Noon session

S.NO	Branch	Strength	Present	Absent	Permission
1	CSE	17	16	0	1
2	ECE - A	22	20	2	0
3	ECE - B	18	18	0	0
4	EEE - A	23	22	1	0
5	EEE - B	31	30	1	0
6	IT	16	16	0	0
Total		127	122	4	1

After Noon session

S.NO	BRANCH	Strength	Present	Absent	Leave
1	CSE	17	16	0	1
2	ECE - A	22	20	2	0
3	ECE - B	18	18	0	0
4	EEE - A	23	22	1	0
5	EEE - B	31	30	1	0
6	IT	16	16	0	0
Total		127	122	4	1

[Signature]
T & P OFFICER

[Signature]
T&P CO ORDINATOR

[Signature]
PRINCIPAL
PRINCIPAL,
K. S. R. INSTITUTE FOR
ENGINEERING AND TECHNOLOGY,
K. S. R. KALVI NAGAR,
TIRUCHENGODE-637 215,
NAMAKKAL Dt. TAMIL NADU.

Training programme for Wipo By Six Phrase

BATCH: 2015 - 2019

ACADEMIC YEAR: 2018 - 2019 (ODD)

DATE: 06.09.2018

Fore Noon session

S.NO	Branch	Strength	Present	Absent	Permission
1	CSE	17	16	0	1
2	ECE - A	22	18	4	0
3	ECE - B	18	17	1	0
4	EEE - A	23	20	2	1
5	EEE - B	31	30	0	1
6	IT	16	16	0	0
Total		127	117	7	3

After Noon session

S.NO	BRANCH	Strength	Present	Absent	Leave
1	CSE	17	16	0	1
2	ECE - A	22	18	4	0
3	ECE - B	18	17	1	0
4	EEE - A	23	20	2	1
5	EEE - B	31	30	0	1
6	IT	16	15	1	0
Total		127	116	8	3

T & P OFFICER

T & P CO ORDINATOR

PRINCIPAL
K. S. R. INSTITUTE FOR
ENGINEERING AND TECHNOLOGY,
K. S. R. KALVI NAGAR,
TIRUCHENGODE-637 215,
NAMAKKAL Dt, TAMIL NADU.

Training programme for Wipo By Six Phrase

BATCH: 2015 - 2019

ACADEMIC YEAR: 2018 - 2019 (ODD)

DATE: 07.09.2018

Fore Noon session

S.NO	Branch	Strength	Present	Absent	Permission
1	CSE	7	7	0	0
2	ECE - A	16	13	3	0
3	ECE - B	13	12	1	0
4	EEE - A	20	19	1	0
5	EEE - B	24	22	1	1
6	IT	16	15	1	0
Total		96	88	7	1

After Noon session

S.NO	BRANCH	Strength	Present	Absent	Leave
1	CSE	7	7	0	0
2	ECE - A	16	13	3	0
3	ECE - B	13	12	1	0
4	EEE - A	20	19	1	0
5	EEE - B	24	22	1	1
6	IT	16	15	1	0
Total		96	88	7	1

T & P OFFICER

T & P CO ORDINATOR

PRINCIPAL
K. S. R. INSTITUTE FOR
ENGINEERING AND TECHNOLOGY
K. S. R. KALVI NAGAR,
TIRUCHENGODE - 637 215,
NAMAKKAL DL, TAMIL NADU.

Name of the Student: R. DivyaBranch: ITYear / Sem: IV - VII1. Name of the Training: Aptitude training

2. Name of the Trainer :

3. Students rating of Trainers : 9

S. No.	Date	Subject	Rating (✓)			
			Excellent	Very good	Good	Average
1	04.09.18	Quantitative	✓			

4. Two positive points about the programme: Learn more shortcuts in Quants
Get clear idea about verbal topics.

5. Suggestions for improvement: NothingDate: 04.09.18

R. Divya
Signature

Name of the Student: G. HemalathaBranch: ITYear / Sem: IV - VII4. Name of the Training: Verbal Training

5. Name of the Trainer :

6. Students rating of Trainers :

S. No.	Date	Subject	Rating (✓)			
			Excellent	Very good	Good	Average
1	04.09.18	Verbal	✓			

4. Two positive points about the programme: Get clear idea about verbal topics

5. Suggestions for improvement:

Date: 04.09.18

G. Hemalatha
Signature

PRINCIPAL,
K. S. R. INSTITUTE FOR
ENGINEERING AND TECHNOLOGY,
K. S. R. KALVI NAGAR,
TIRUCHENGODE - 637 215,
NAMAKKAL Dt, TAMIL NADU.

TRAINING PROGRAMME FEEDBACK FORM



Name of the Student: S. Dhanyaraj

Branch: B.Tech (IT)

Year / Sem: 04 / 07

1. Name of the Training : INFOSYS TRAINING

2. Name of the Trainer : SASILEKHA

3. Students rating of Trainers :

S. No.	Date	Subject	Rating (✓)			
			Excellent	Very good	Good	Average
1	09.12.18	QUANTS / VERBAL	✓			

4. Two positive points about the programme: -

5. Suggestions for improvement: More quants solving through tricks not formulae

Date: 07/12/18

S. Dhanyaraj
Signature

TRAINING PROGRAMME FEEDBACK FORM



Name of the Student: S. Haini

Branch: EEE

Year / Sem: IV / VII

4. Name of the Training : Verbal , Apps

5. Name of the Trainer : Sasi Rekha , Arun

6. Students rating of Trainers :

S. No.	Date	Subject	Rating (✓)			
			Excellent	Very good	Good	Average
1	9/12/18	Percentage , Reading comprehension		✓		

4. Two positive points about the programme: Learned shortcuts.

Tricks for time minimization for problem solving.

5. Suggestions for improvement: NEP

PRINCIPAL,
K. S. R. INSTITUTE FOR
ENGINEERING AND TECHNOLOGY,
K. S. R. KALVI NAGAR,
TIRUCHENGODE 637 215,
NAMAKKAL Dt, TAMIL NADU.

Date: 9-12-18



Name of the Student: T. Gunabharathi Branch: CSE-IV

Year / Sem: IV / VII

1. Name of the Training: Sasirekha Infocsys Training

2. Name of the Trainer: Sasirekha

3. Students rating of Trainers :

S. No.	Date	Subject	Rating (✓)			
			Excellent	Very good	Good	Average
1	8.12.18	verbal		✓		

4. Two positive points about the programme:

we remember all the topic in verbal

5. Suggestions for improvement:

NO suggestions.

Date:

Signature



Name of the Student: DHANUSVADEVI S Branch: PT (B.Tech)

Year / Sem: 02 / 07

1. Name of the Training: INFOSYS TRAINING

2. Name of the Trainer: DIVYALAKSHMI

3. Students rating of Trainers :

S. No.	Date	Subject	Rating (✓)			
			Excellent	Very good	Good	Average
1	8.12.18	Verbal / (FN) Ability Reasoning (AN)	✓	✓		

4. Two positive points about the programme: interesting

5. Suggestions for improvement: NO

Date:

8.12.18

PRINCIPAL.
K. S. R. INSTITUTE FOR
ENGINEERING AND TECHNOLOGY,
K S R KALVINAGAR,
TIRUCHENGODE 637 215.
NANDAKHAL DL, TAMIL NADU.

Signature



Name of the Student: D. Sneha

Branch: IT

Year / Sem: IV - 7th

1. Name of the Training: Aptitude & Reasoning

2. Name of the Trainer: Gomathi

3. Students rating of Trainers :

S. No.	Date	Subject	Rating (√)			
			Excellent	Very good	Good	Average
1	4/09/18	Avg Synonyms & Antonyms	✓			

4. Two positive points about the programme:

Very clearly understand the topics.

5. Suggestions for improvement:

Date: 4/9/18

D. Sneha
Signature



Name of the Student: P. Dhanani

Branch: IT

Year / Sem: IV / 7th

4. Name of the Training: Aptitude / Reasoning

5. Name of the Trainer: Sasireka

6. Students rating of Trainers :

S. No.	Date	Subject	Rating (√)			
			Excellent	Very good	Good	Average
1	4/9/18	Synonyms / Antonyms.	✓			

4. Two positive points about the programme:

Many shortcuts are learned.

5. Suggestions for improvement:

Date: 4/9/18

PRINCIPAL.
K. S. R. INSTITUTE FOR
ENGINEERING AND TECHNOLOGY,
K. S. R. KALVI NAGAR,
TIRUCHENGODE-637 215,
NAMAKKAL DI, TAMIL NADU.

P. Dhanani
Signature

K S R INSTITUTE FOR ENGINEERING AND TECHNOLOGY
TIRUCHENGODE - 637 215

TRAINING PROGRAMME FEEDBACK FORM



Name of the Student: C.V. Vinodhini

Branch: ECE

Year / Sem: VII / Final year

1. Name of the Training: Attitude Training

2. Name of the Trainer: Sasi Rekha

3. Students rating of Trainers: (9.00 to 10.45)

S. No.	Date	Subject	Rating (√)			
			Excellent	Very good	Good	Average
1	2.9.18	Idiom & phrase	✓			

4. Two positive points about the programme:

#1 clarifying doubts very well

5. Suggestions for improvement:

no suggestion

Date: 4/9/2018

[Signature]
Signature

K S R INSTITUTE FOR ENGINEERING AND TECHNOLOGY
TIRUCHENGODE - 637 215

TRAINING PROGRAMME FEEDBACK FORM



Name of the Student: C. Vinodhini

Branch: ECE

Year / Sem: Final year / VII

4. Name of the Training: Attitude Training

5. Name of the Trainer: George

6. Students rating of Trainers: (10.45 to 12.30)

S. No.	Date	Subject	Rating (√)			
			Excellent	Very good	Good	Average
1		Direct / indirect speech Active & passive voice	✓			

4. Two positive points about the programme:

#1 Learned more about active and passive voice

5. Suggestions for improvement:

no suggestion

Date: 4/9/2018

PRINCIPAL,
K. S. R. INSTITUTE FOR
ENGINEERING AND TECHNOLOGY,
K. S. R. KALVIA
TIRUCHENGODE - 637 215,
NAMAKKAL DI, TAMIL NADU.

TIRUCHENGODE - 637 215
TRAINING PROGRAMME FEEDBACK FORM



Name of the Student: L Keerthana Branch: ECE

Year / Sem: IV / VII

1. Name of the Training: Sasi Rekha, Verbal

2. Name of the Trainer: Sasi Rekha

3. Students rating of Trainers :

S. No.	Date	Subject	Rating (✓)			
			Excellent	Very good	Good	Average
1	04/09/18	Verbal		✓		

4. Two positive points about the programme: easy to learn
very interesting

5. Suggestions for improvement: Subject clarity should be improved.

Date: 04/09/18

L. Keerthana
Signature

K S R INSTITUTE FOR ENGINEERING AND TECHNOLOGY
TIRUCHENGODE - 637 215
TRAINING PROGRAMME FEEDBACK FORM



Name of the Student: S. Harini Branch: EEE

Year / Sem: IV / VII

4. Name of the Training: Verbal

5. Name of the Trainer :

6. Students rating of Trainers :

S. No.	Date	Subject	Rating (✓)			
			Excellent	Very good	Good	Average
1	04/09/18	Verbal		✓		

4. Two positive points about the programme: Time management is good.
get somewhat clarity in Verbal.

5. Suggestions for improvement:

Date: 04/09/18

S. Harini
PRINCIPAL.
K. S. R. INSTITUTE FOR
ENGINEERING AND TECHNOLOGY,
K. S. R. KALVI NAGAR,
TIRUCHENGODE 637 215,
NAMAKKAL Dt. TAMIL NADU.



Name of the Student: P. Elanchezhyan

Branch: EEE

Year / Sem: IV - 7th sem

1. Name of the Training: George William Direct & indirect speech, Active & passive voice

2. Name of the Trainer: George William

3. Students rating of Trainers :

S. No.	Date	Subject	Rating (✓)			
			Excellent	Very good	Good	Average
1	4/09/18	Verbal		✓		

4. Two positive points about the programme: * Known clearly about both the topics
* Spoke in English with students

5. Suggestions for improvement:

* Make the students to speak in English

Date: 4/09/18

P. Elanchezhyan
Signature



Name of the Student: S. R. Ramesh

Branch: EEE

Year / Sem: IV - 7th sem

4. Name of the Training: Probability And Average

5. Name of the Trainer: Gomathi

6. Students rating of Trainers :

S. No.	Date	Subject	Rating (✓)			
			Excellent	Very good	Good	Average
1	4/09/18	Quantitative				✓

4. Two positive points about the programme: * ~~she~~ ^{she} move friendshipness.

* ~~she~~ ^{she} give some suggestions to

5. Suggestions for improvement:

* She will ^{not} solve a problems properly.

Date: 4/09/18

Ramesh
Signature
K. S. R. INSTITUTE FOR
ENGINEERING AND TECHNOLOGY
K. S. R. KALVI NAGAR,
TIRUCHENGODE - 637 215,
NAMAKKAL DI. TAMIL NADU.



Name of the Student: S. Nisha Branch: CSE

Year / Sem: IV

1. Name of the Training: Aptitude Training

2. Name of the Trainer: Sabit Datta

3. Students rating of Trainers: (2 to 3.00)

S. No.	Date	Subject	Rating (✓)			
			Excellent	Very good	Good	Average
1	5/9/18	verbal, reasoning	✓			

4. Two positive points about the programme:
Teach very clear, more activities

5. Suggestions for improvement:
NO

Date:

S. Nisha
Signature



Name of the Student: S. Nisha Branch: CSE

Year / Sem: IV

4. Name of the Training: Aptitude Training

5. Name of the Trainer: George

6. Students rating of Trainers: (3.10 to 4.45)

S. No.	Date	Subject	Rating (✓)			
			Excellent	Very good	Good	Average
1	5/9/18	sentence, error finding			✓	

4. Two positive points about the programme:
FO more exercise, practice

5. Suggestions for improvement:

Date:

PRINCIPAL,
K. S. R. INSTITUTE FOR
ENGINEERING AND TECHNOLOGY,
K. S. R. KALVI NAGAR
TIRUCHENGODE - 637 215,
NAMAKKAL DT, TAMIL NADU.

S. Nisha
Signature



Name of the Student: HARIHARAN G Branch: B.E. FEE

Year / Sem: IV / 7th Sem

1. Name of the Training : SIX PHASE

2. Name of the Trainer : GEORGE

3. Students rating of Trainers :

S. No.	Date	Subject	Rating (✓)			
			Excellent	Very good	Good	Average
1	05/09/2018	selecting words		✓		

4. Two positive points about the programme:
To understand about the concept.

5. Suggestions for improvement:
To cover topic slowly to understand on basis.

Date: 05/09/2018

George
Signature



Name of the Student: GOKULAKRISHNAN. P Branch: BEE

Year / Sem: IV / VII

4. Name of the Training : SIX PHASE

5. Name of the Trainer :

6. Students rating of Trainers :

S. No.	Date	Subject	Rating (✓)			
			Excellent	Very good	Good	Average
1	05/09/2018	Probability		✓		

4. Two positive points about the programme:
Easy to learn the concept
The way of learning is good.

5. Suggestions for improvement:

Date: 05/09/2018

PRINCIPAL.
K. S. R. INSTITUTE FOR
ENGINEERING AND TECHNOLOGY,
K. S. R. KALVI NAGAR,
TIRUCHENGODE-637 215,
NAMAKKAL DI, TAMIL NADU.

S. Gohy
Signature

TIRUCHENGODE - 637 215
TRAINING PROGRAMME FEEDBACK FORM



Name of the Student: T. Prithvi

Branch: IT

Year / Sem: V / VII

1. Name of the Training : English

2. Name of the Trainer : D. Prasad

3. Students rating of Trainers :

S. No.	Date	Subject	Rating (√)			
			Excellent	Very good	Good	Average
1	5.4.2017	synonyms		✓		

4. Two positive points about the programme:

It gives meaning for many words and easy to transfer your language.

5. Suggestions for improvement:

Nothing

Date: 5.4.2018

T. Prithvi
Signature

K S R INSTITUTE FOR ENGINEERING AND TECHNOLOGY
TIRUCHENGODE - 637 215
TRAINING PROGRAMME FEEDBACK FORM



Name of the Student: M. B. Zhi

Branch: EE

Year / Sem: IV / VII

4. Name of the Training : Sp. course

5. Name of the Trainer :

6. Students rating of Trainers :

S. No.	Date	Subject	Rating (√)			
			Excellent	Very good	Good	Average
1	5.9.2018	Hardwords		✓		

4. Two positive points about the programme:

It is useful for learn new language.

5. Suggestions for improvement:

Nothing

Date: 5.9.2018

PRINCIPAL,
K. S. R. INSTITUTE FOR
ENGINEERING AND TECHNOLOGY
K. S. R. KALVI NAGAR,
TIRUCHENGODE - 637 215,
NAMAKKAL DI, TAMIL NADU.



Name of the Student: K. Jhirumalaisajan

Branch: B.Tech (IT)

Year / Sem: IV year / 7th sem

1. Name of the Training: aptitude training

2. Name of the Trainer: sasireka

3. Students rating of Trainers: 9 to 10.45

S. No.	Date	Subject	Rating (✓)			
			Excellent	Very good	Good	Average
1	05/09/2018	Spelling		✓		

4. Two positive points about the programme:

easy to understand concept

5. Suggestions for improvement:

Nil

Date:

K. Jhirumalaisajan
Signature



Name of the Student: P. Uowham

Branch: B.Tech (IT)

Year / Sem: IV year / 7th year

4. Name of the Training: aptitude training

5. Name of the Trainer: George

6. Students rating of Trainers: 11.00 to 12.30

S. No.	Date	Subject	Rating (✓)			
			Excellent	Very good	Good	Average
1	05/09/18	Sentence formation		✓		

4. Two positive points about the programme:

I have easy learned in english.

5. Suggestions for improvement:

Nil

Date: 05.09.18

PRINCIPAL.
K. S. R. INSTITUTE FOR
ENGINEERING AND TECHNOLOGY,
K. S. R. KALVI NAGAR,
TIRUCHENGODE 637 215
NAMAKKAL DI, TAMIL NADU.
Chief P.
Signature



Name of the Student: T. Gunabharathi

Branch: CSP - IV

Year / Sem: IV / VII

1. Name of the Training: verbal aptitude

2. Name of the Trainer :

3. Students rating of Trainers :

9 to 10.45

S. No.	Date	Subject	Rating (✓)			
			Excellent	Very good	Good	Average
1	6.9.18	completing statements, sentence correction		✓		

4. Two positive points about the programme:

We all know how to make and correct the sentence.

5. Suggestions for improvement:

N/A

Date: 6.9.18

To Guy
Signature



Name of the Student: T. Gunabharathi

Branch: CSP

Year / Sem: IV / VII

4. Name of the Training: verbal aptitude

5. Name of the Trainer :

6. Students rating of Trainers :

10.45 to 12.30

S. No.	Date	Subject	Rating (✓)			
			Excellent	Very good	Good	Average
1	6.9.18	classification logical sequence of words		✓		

4. Two positive points about the programme:

We all know easy to find different words easily and all know the complex word meaning. It is very useful session.

5. Suggestions for improvement:

N/A

Date: 6.9.18

To Guy
Signature
K. S. R. INSTITUTE FOR
ENGINEERING AND TECHNOLOGY
K. S. R. KALVI NAGAR,
TIRUCHENGODE-637 215
NAMAKKAL DL, TAMIL NADU.



TRAINING PROGRAMME FEEDBACK FORM

Name of the Student: Bhuvaneshwari. R Branch: ECE

Year / Sem: IV / 7th sem

1. Name of the Training: Aptitude Training

2. Name of the Trainer: -

3. Students rating of Trainers: 1.30 to 3.00

S. No.	Date	Subject	Rating (✓)			
			Excellent	Very good	Good	Average
1	6/9/18	Permutation & Combination		✓		

4. Two positive points about the programme:

Very Interesting in Solving Problems

5. Suggestions for improvement:

Date: 6/9/18

[Signature]
Signature



TRAINING PROGRAMME FEEDBACK FORM

Name of the Student: Bhuvaneshwari. R Branch: ECE

Year / Sem: IV / 7th sem

4. Name of the Training: Aptitude Training (Verbal)

5. Name of the Trainer: -

6. Students rating of Trainers: 3.10 to 4.45

S. No.	Date	Subject	Rating (✓)			
			Excellent	Very good	Good	Average
1	6/9/18	Sentence Correction one word Substitution		✓		

4. Two positive points about the programme:

Eagered in learning new words & Correcting the Sentence

5. Suggestions for improvement:

Date: 6/9/18

PRINCIPAL,
K. S. R. INSTITUTE FOR
ENGINEERING AND TECHNOLOGY,
K. S. R. KALVI NAGAR,
TIRUCHENGODE-637 215,
NAMAKKAL DI. TAMIL NADU.

[Signature]
Signature



Name of the Student: R. Swathi

Branch: EEE

Year / Sem: IV / 07

1. Name of the Training : Verbal aptitude.

2. Name of the Trainer : Sasi Rekha

3. Students rating of Trainers :

S. No.	Date	Subject	Rating (✓)			
			Excellent	Very good	Good	Average
1	6/9/18	1. Spelling 2. Selecting word			✓	

4. Two positive points about the programme:

doubt clarification session is good.
More examples given.

5. Suggestions for improvement:

In between we need some relaxation.

Date: 6/9/18

R. Swathi
Signature



Name of the Student: S. Priyanka

Branch: IT

Year / Sem: IV / 07

4. Name of the Training : verbal APTITUDE

5. Name of the Trainer : Sasi Rakha

6. Students rating of Trainers :

S. No.	Date	Subject	Rating (✓)			
			Excellent	Very good	Good	Average
1	6/9/18	1. permutation 2. selecting word			✓	

4. Two positive points about the programme:

we Learn Lot of different English word.

5. Suggestions for improvement:

doubt clarification very good.
Give more additional knowledge

Date: 6/9/18

S. Priyanka
Signature

PRINCIPAL.
K. S. R. INSTITUTE FOR
ENGINEERING AND TECHNOLOGY,
K. S. R. KALVI NAGAR,
TIRUCHENGODE-637 215,
NAMAKKAL Dt. TAMIL NADU.

Name of the Student: T. HariniBranch: ECEYear / Sem: IV / VII1. Name of the Training: Six Phrase

2. Name of the Trainer :

3. Students rating of Trainers :

S. No.	Date	Subject	Rating (✓)			
			Excellent	Very good	Good	Average
1	6/9/18	Permutation & combination		✓		

4. Two positive points about the programme:

Training was very informative. The trainer was able to explain difficult to understand problems in simple terms.

5. Suggestions for improvement:

- Nothing -

Date: 6/9/18

T. Harini
Signature

Name of the Student: M. EzhilBranch: ECEYear / Sem: IV / VII4. Name of the Training: Six phrase

5. Name of the Trainer :

6. Students rating of Trainers :

S. No.	Date	Subject	Rating (✓)			
			Excellent	Very good	Good	Average
1	6/9/18	Sentence selection		✓		

4. Two positive points about the programme:

All aspects are clearly explained

5. Suggestions for improvement:

- Nothing -

Date: 6/9/18

PRINCIPAL,
K. S. R. INSTITUTE FOR
ENGINEERING AND TECHNOLOGY,
K. S. R. KALVI NAGAR,
TIRUCHENGODE-637 215
NAMAKKAL DI, TAMIL NADU.

M.S.
Signature



Name of the Student: A. Mohammed Riyas Branch: EEE

Year / Sem: Final - 7th

1. Name of the Training: Quantitative Aptitude

2. Name of the Trainer: Gowathi

3. Students rating of Trainers :

S. No.	Date	Subject	Rating (√)			
			Excellent	Very good	Good	Average
1	7-09-18	Time speed and distence			✓	

4. Two positive points about the programme:

1. More Example solve on class.
2. Doubt clear Better.

5. Suggestions for improvement:

1. Need more Basic logical problem solving.

Date: 7/9/18 weekly twice Aptitude courses need. [Signature]
Signature



Name of the Student: M. Sathish Kumar Branch: EEE

Year / Sem: VI / 7th

4. Name of the Training: Verbal Aptitude

5. Name of the Trainer: Sasi Retha

6. Students rating of Trainers :

S. No.	Date	Subject	Rating (√)			
			Excellent	Very good	Good	Average
1	7-9-18	completing sentence		✓		

4. Two positive points about the programme:

1. Doubt clear Better.
2. Very good explanation

5. Suggestions for improvement:

1. Wee'ly twice need aptitude courses.

Date: 7/9/18

PRINCIPAL,
K. S. R. INSTITUTE FOR
ENGINEERING AND TECHNOLOGY,
K. S. R. KALVI NAGAR,
TIRUCHENGODE-637 215,
NAMAKKAL Dt, TAMIL NADU.

[Signature]
Signature



Name of the Student: C.KEERTHIKA

Branch: EEE

Year / Sem: IV - VII

1.Name of the Training :

2.Name of the Trainer : Gomathi, sasi rekha

3.Students rating of Trainers :

S. No.	Date	Subject	Rating (√)			
			Excellent	Very good	Good	Average
1	07/09/18	Time, Speed, Distance			✓	

4. Two positive points about the programme:

Good teaching
Easyly understand

5. Suggestions for improvement:

want more examples.

Date: 07/09/18

C. Keerthika
Signature



Name of the Student: S. PRIYADHARSHINI

Branch: EEE

Year / Sem: IV - VII

4.Name of the Training :

5.Name of the Trainer : Gomathi , Sasi Rekha

6.Students rating of Trainers :

S. No.	Date	Subject	Rating (√)			
			Excellent	Very good	Good	Average
1	7/9/18	Boat, Stream			✓	

4. Two positive points about the programme:

Very well knowledge

Easy understand

5. Suggestions for improvement:

Decrate the question

Date: 7/9/18

S. Prudhvi
PRINCIPAL.
K. S. R. INSTITUTE FOR
ENGINEERING AND TECHNOLOGY,
K. S. R. KALVI NAGAR,
TIRUCHENGODE-637 215,
NAMAKKAL DI, TAMIL NADU.

Signature



Name of the Student: S. Denmozhi

Branch: IT

Year / Sem: Final year

1. Name of the Training : Aptitude

2. Name of the Trainer : Sasirekha

3. Students rating of Trainers :

S. No.	Date	Subject	Rating (✓)			
			Excellent	Very good	Good	Average
1	7.9.18	Qualitative aptitude			✓	

4. Two positive points about the programme:

Logical thinking is good

5. Suggestions for improvement:

Give the break inbetween.

Date: 7/9/18

[Signature]
Signature



Name of the Student: S. Priyanka

Branch: B.Tech IT

Year / Sem: Final year / 07

4. Name of the Training : Aptitude

5. Name of the Trainer : Sasirekha

6. Students rating of Trainers :

S. No.	Date	Subject	Rating (✓)			
			Excellent	Very good	Good	Average
1	7.9.18	Quantitative Aptitude			✓	

4. Two positive points about the programme:

① The trainers are given valuable inputs
② they are good in too interactive with student

5. Suggestions for improvement:

① give more Logical

Date: 7/9/18 problem

[Signature]
PRINCIPAL,
K. S. R. INSTITUTE
ENGINEERING AND TECHNOLOGY,
K. S. R. KALVI NAGAR,
TIRUCHENGODE-637 215,
NAMAKKAL DI. TAMIL NADU.



Name of the Student: K. Gayathri

Branch: B.E/EEE

Year / Sem: IV / VII

1.Name of the Training : Quantitative Aptitude

2.Name of the Trainer : Gomathi

3.Students rating of Trainers :

S. No.	Date	Subject	Rating (✓)			
			Excellent	Very good	Good	Average
1	07.09.2018	Time Speed & Distance		✓		

4. Two positive points about the programme:

Give clear Information And how to Proceed the Problem.

5. Suggestions for improvement:

Gives us Many Examples to Workout the Q'ums.
Need to teach More topics.

Date: 07.09.2018

K. Gayathri
Signature



Name of the Student: R. Jagan

Branch: EEE

Year / Sem: IV / VII

4.Name of the Training : Verbal Reasoning

5.Name of the Trainer : Sasirekha

6.Students rating of Trainers :

S. No.	Date	Subject	Rating (✓)			
			Excellent	Very good	Good	Average
1	07.09.2018	Selecting words Complete Statements		✓		

4. Two positive points about the programme:

Gives us Clear Explanation about the Words and sentences.
Teach us well as good.

5. Suggestions for improvement:

Need to Give More Examples.

Date: 07.09.2018

PRINCIPAL.
K. S. R. INSTITUTE FOR
ENGINEERING AND TECHNOLOGY,
K. S. R. KALVI NAGAR,
TIRUCHENGODE-637 215,
NAMAKKAL Dt, TAMIL NADU.

R. Jagan
Signature

TRAINING AND PLACEMENT CELL



Training Schedule [2018-2019] ODD Semester

Ref: KSRIET/T&P/CIR/2018-2019

Date: 01.12.2018

This is to inform that all the HoD's and Training and Placement coordinators that the company specific training for IV year students(Advanced Learners) for the academic year 2018-2019 (Odd Sem) is scheduled as given below. All the eligible students should attend the Training Programme without fail. If any student skips this Training Programme he / she will not be permitted for any further Training Programme and campus recruitment process. Proper Dress Code is mandatory.

S.NO	Date	Batch	Students Strength	Resource Person
1	05.12.2018 & 06.12.2018	2015-2019	MECH(8) Total=08	Mr.D.RameshKumar ,AP/MECH

Session FN: 9.00 AM to 12.30 PM & Break: 10.45 AM to 11.00AM

Session AN: 01.15.PM to 04.15 PM & Lunch: 12.30 PM to 01.15 PM

[Signature]
T&P Officer

[Signature]
T&P Coordinator

[Signature]
Principal

- Copy to:
1. All HoDs
 2. Notice Board

[Signature]
PRINCIPAL.
K. S. R. INSTITUTE FOR
ENGINEERING AND TECHNOLOGY,
K. S. R. KALVI NAGAR,
TIRUCHENGODE-637 215,
NAMAKKAL Dt. TAMIL NADU.

26

K S R INSTITUTE FOR ENGINEERING AND TECHNOLOGY, TIRUCHENGODE - 637215

Training and Placement Cell

Borg Warner Internal Training Programme - 05.12.2018 -06.12.2018

S.No.	Reg.No.	Name	Branch
1	731615114001	ADHISHANKARAN D	MECH
2	731615114042	GABY SACHIN S	MECH
3	731615114055	JACKSON P V	MECH
4	731615114098	NISHANTHI B	MECH
5	731615114117	SAI HARISH V	MECH
6	731615114123	SANTHOSH KUMAR R	MECH
7	731615114146	SURYA S C	MECH
8	731615114158	VIGNESH M	MECH

PRINCIPAL,
K. S. R. INSTITUTE FOR
ENGINEERING AND TECHNOLOGY,
K. S. R. KALVI NAGAR,
TIRUCHENGODE-637 215,
NAMAKKAL Dt, TAMIL NADU.

(Approved by AICTE, New Delhi and Affiliated by Anna University, Chennai)

TRAINING AND PLACEMENT CELL

Borg Warner Internal Training Programme

Academic year : 2018-2019

Date: 05.12.2018 & 06.12.2018

Student Attendance

S.No	Register No	Name of the Student	05.12.2018		06.12.2018	
			FN	AN	FN	AN
1.	731615114001	ADHISHANKARAN	P	P	P	P
2.	731615114042	GABY SACHIN S	P	P	AB	AB
3.	731615114055	JACKSON P V	P	P	P	P
4.	731615114098	NISHANTHINI B	P	P	P	P
5.	731615114117	SAI HARISH V	AB	AB	P	P
6.	731615114123	SANTHOSH KUMAR R	P	P	AB	AB
7.	731615114146	SURYA S C	P	P	P	P
8.	731615114158	VIGNESH M	P	P	P	P

PRINCIPAL.
K. S. R. INSTITUTE FOR
ENGINEERING AND TECHNOLOGY,
K. S. R. KALVI NAGAR,
TIRUCHENGODE-637 215,
NAMAKKAL DI, TAMIL NADU.

**K S R INSTITUTE FOR ENGINEERING AND TECHNOLOGY
TIRUCHENGODE – 637 215**

TRAINING PROGRAMME FEEDBACK FORM



Name of the Student: Jackson PV Branch: Meek

Year / Sem: IV - 1

1. Name of the Training : Prog found entered

2. Name of the Trainer : Gopal

3. Students rating of Trainers : 4/5

S. No.	Date	Subject	Rating (√)			
			Excellent	Very good	Good	Average
1	5/12/18	Java		✓		

4. Two positive points about the programme:

It was useful

5. Suggestions for improvement:

Need more content

Date: 5/12/18

Jackson
Signature

**K S R INSTITUTE FOR ENGINEERING AND TECHNOLOGY
TIRUCHENGODE – 637 215**

TRAINING PROGRAMME FEEDBACK FORM



Name of the Student: Nishanth B Branch: Meek

Year / Sem: IV - 1

1. Name of the Training : Prog found entered

2. Name of the Trainer : Ranjith Kumar

3. Students rating of Trainers : 4/5

S. No.	Date	Subject	Rating (√)			
			Excellent	Very good	Good	Average
1	5/12/18			✓		

4. Two positive points about the programme:

It was useful

5. Suggestions for improvement:

Need more content

Date: 5/12/18

Nishanth
Signature

PRINCIPAL,
K. S. R. INSTITUTE FOR
ENGINEERING AND TECHNOLOGY,
K. S. R. KALVI NAGAR,
TIRUCHENGODE-637 215,
NAMAKKAL Dt., TAMIL NADU.

TRAINING AND PLACEMENT CELL



Training Schedule [2018-2019] ODD Semester

Ref: KSRIET/T&P/CIR/2018-2019

Date: 05.12.2018

This is to inform that all the HoD's and Training and Placement coordinators that the company specific training for IV year students(Advanced Learners) for the academic year 2018-2019 (ODD Sem) is scheduled as given below. All the eligible students should attend the Training Programme without fail. If any student skips this Training Programme he / she will not be permitted for any further Training Programme and campus recruitment process. Proper Dress Code is mandatory.

S.NO	Date	Batch	Students Strength	Resource Person
1	08.12.18, 09.12.18 & 11.12.18	2015-2019	CSE(8),ECE(11), & EEE(7),IT(2), MECH(2) Total=22	SASIREKHA, DIVYALAKSHMI, ARUN, GEORGE.

Session FN: 9.00 AM to 12.30 PM & Break: 10.45 AM to 11.00AM

Session AN: 01.15.PM to 04.15 PM & Lunch: 12.30 PM to 01.15 PM

T&P Officer

T&P Coordinator

Principal

- Copy to:
1. All HoDs
 2. Notice Board

PRINCIPAL.
K. S. R. INSTITUTE FOR
ENGINEERING AND TECHNOLOGY,
K. S. R. KALVI NAGAR,
TIRUCHENGODE-637 215,
NAMAKKAL DT, TAMIL NADU.

K S R INSTITUTE FOR ENGINEERING AND TECHNOLOGY

TRAINING AND PLACEMENT CELL

INFOSYS TRAINING ATTENDANCE

S.NO	REG NO	NAME	DEPT	8.12.18	9.12.18	11.12.18
1	731615104007	BOOPATHIRAJA M	CSE	← Placed →		
2	731615104012	GUNA BHARATHI T ✓	CSE	/	/	/
3	731615104016	KIRUBHANANDHAN P ✓	CSE	/	/a	a
4	731615104019	MOHANRAJ C ✓ OFS	CSE	a	a	a
5	731615104023	NISHA S ✓	CSE	/	/	a
6	731615104029	PRAVEEN G ✓	CSE	a	a	a
7	731615104030	PRIYADHARSHINI R ✓ OFS	CSE	a	a	a
8	731615104033	SAKTHIVEL E ✓	CSE	/a	a	a
9	731615106009	BHUVANESWARI R ✓	ECE	/	/	/
10	731615106015	DHIVYA.M ✓	ECE	/	/	a
11	731615106024	GOWRI.P ✓ OFS ✓	ECE	P	a	/
12	731615106032	KARTHIKA.D ✓	ECE	/	/	/
13	731615106036	KAVIPREETHI.V ✓	ECE	/	/	/
14	731615106041	KOWSALYA.C ✓	ECE	/	/	/
15	731615106054	PAVITHRA P ✓	ECE	/	P	/
16	731615106059	PRIYADHARSHINI.S ✓	ECE	/	/	/
17	731615106074	TAMILARASI J ✓	ECE	/	/	/
18	731615106077	UMA MAHESHWARI M ✓	ECE	/	/	/
19	731615106079	VINOTHINI G ✓	ECE	/	/	/
20	731615105012	GAYATHRI K ✓	EEE	a	a	/
21	731615105017	GOKULAKRISHNAN S ✓	EEE	/	P	/
22	731615105029	HARINI S ✓	EEE	P	/	/
23	731615105057	MURUGANANTH M ✓	EEE	← Permission →		
24	731615105073	SOUNDHARYA S ✓	EEE	P	a	/
25	731615105086	YOGAPRIYA S ✓	EEE	a	/	/
26	731615105087	YOGESHWARAN S ✓	EEE	a	a	a
27	731615205012	DHANUSYADEVI.S ✓	IT	/	/	a
28	731615205038	SNEKA D ✓	IT	/	/	/
29	731615114115	ROBERT SAM DANIEL ✓	MECH	/	/a	a
30	731615114066	KAVIPRIYAN S ✓	MECH	P	/a	a

PRINCIPAL.
K. S. R. INSTITUTE FOR
ENGINEERING AND TECHNOLOGY.
K. S. R KALVI NAGAR.
TIRUCHENGODE -637 215.
NAMAKKAL DI. TAMIL NADU.

(14) members.

Infosys Specific Training programme By Six Phrase

BATCH: 2015 - 2019

ACADEMIC YEAR: 2018 - 2019 (ODD)

DATE: 08.12.2018

Fore Noon session

S.NO	Branch	Strength	Present	Absent	Permission
1	CSE	7	4	3	0
2	ECE	11	10	0	1
4	EEE	6	1	3	2
5	IT	2	2	0	0
6	MECH	2	1	0	1
Total		28	18	6	4

. After Noon session

S.NO	Branch	Strength	Present	Absent	Permission
1	CSE	7	3	4	0
2	ECE	11	10	0	1
4	EEE	6	1	3	2
5	IT	2	2	0	0
6	MECH	2	1	0	1
Total		28	17	7	4

[Signature]
T & P OFFICER

[Signature]
T&P CO ORDINATOR

[Signature]
PRINCIPAL
K. S. R. INSTITUTE FOR
ENGINEERING AND TECHNOLOGY,
K. S. R. KALVI NAGAR,
TIRUCHENGODE-637 215,
NAMAKKAL Dt, TAMIL NADU.

[Signature]
PRINCIPAL

Infosys Specific Training programme By Six Phrase

BATCH: 2015 - 2019

ACADEMIC YEAR: 2018 - 2019 (ODD)

DATE: 09.12.2018

Fore Noon session

S.NO	Branch	Strength	Present	Absent	Permission
1	CSE	7	3	4	0
2	ECE	11	10	1	0
4	EEE	6	2	1	3
5	IT	2	2	0	0
6	MECH	2	2	0	1
Total		28	19	6	4

After Noon session

S.NO	Branch	Strength	Present	Absent	Permission
1	CSE	7	2	5	0
2	ECE	11	10	1	0
4	EEE	6	2	1	3
5	IT	2	2	0	0
6	MECH	2	0	2	0
Total		28	16	9	3

T & P OFFICER
9/12/18

T & P CO ORDINATOR
9/12/18

PRINCIPAL
K. S. R. INSTITUTE FOR
ENGINEERING AND TECHNOLOGY
K. S. R. KALVI NAGAR
TIRUCHENGODE-637 215,
NAMAKKAL DI, TAMIL NADU.
9/12/18

Infosys Specific Training programme By Six Phrase

BATCH: 2015 - 2019

ACADEMIC YEAR: 2018 - 2019 (ODD)

DATE: 11.12.2018

Fore Noon session

S.NO	Branch	Strength	Present	Absent	Permission
1	CSE	7	1	6	0
2	ECE	11	10	1	0
4	EEE	6	5	1	0
5	IT	2	1	1	0
6	MECH	2	0	2	0
Total		28	17	11	0

After Noon session

S.NO	Branch	Strength	Present	Absent	Permission
1	CSE	7	1	6	0
2	ECE	11	10	1	0
4	EEE	6	5	1	0
5	IT	2	1	1	0
6	MECH	2	0	2	0
Total		28	17	11	0

T & P OFFICER

T&P CO-ORDINATOR

PRINCIPAL

PRINCIPAL,
K. S. R. INSTITUTE FOR
ENGINEERING AND TECHNOLOGY,
K. S. R. KALVI NAGAR,
TIRUCHENGODE-637 215,
NAMAKKAL Dt. TAMIL NADU.



Name of the Student: Kirubhavanathan P Branch: CCE

Year / Sem: 4 / 6

1. Name of the Training: Verbal Training (Grammar)

2. Name of the Trainer :

3. Students rating of Trainers :

S. No.	Date	Subject	Rating (√)			
			Excellent	Very good	Good	Average
1	9.12.18	Verbal, TOICES, Error spotting		✓		

4. Two positive points about the programme:

Easy to refresh some things

5. Suggestions for improvement:

Date:

Signature



Name of the Student: Robert Sam Daniel Branch: Mechanical

Year / Sem:

4. Name of the Training: Test of Quantitative Aptitude

5. Name of the Trainer :

6. Students rating of Trainers :

S. No.	Date	Subject	Rating (√)			
			Excellent	Very good	Good	Average
1	23/12/18	Verbal, Quantitative aptitude	✓			

4. Two positive points about the programme:

Easily able to grasp the concepts.

5. Suggestions for improvement:

Able to give

PRINCIPAL,
K. S. R. INSTITUTE FOR
ENGINEERING AND TECHNOLOGY,
K S R KALVI NAGAR,
TIRUCHENGODE - 637 215.

TRAINING PROGRAMME FEEDBACK FORM



Name of the Student: PRİYADHARSHINI, S Branch: ECE

Year / Sem: IV / OT

1. Name of the Training : SASSIKALA VERBAL

2. Name of the Trainer : SASSIKALA

3. Students rating of Trainers : 8

S. No.	Date	Subject	Rating (√)			
			Excellent	Very good	Good	Average
1	8.12.18	VERBAL	✓	.		

4. Two positive points about the programme:

Training on verbal was good.

5. Suggestions for improvement:

Teaching process must be slow for better understanding.

Date: 8.12.18

[Signature]
Signature

TRAINING PROGRAMME FEEDBACK FORM



Name of the Student: M. Dhivya Branch: ECE

Year / Sem: IV / 4

1. Name of the Training : REASONING

2. Name of the Trainer : DHIVYALAKSHMI

3. Students rating of Trainers :

S. No.	Date	Subject	Rating (√)			
			Excellent	Very good	Good	Average
1	8.12.18	REASONING	✓			

4. Two positive points about the programme:

Training on reasoning is very useful

5. Suggestions for improvement:

More examples for crypt, etc. needed.

Date: 8.12.18

[Signature]
Signature



Name of the Student: Gr. Vinethini

Branch: ECE

Year / Sem: Final / VII

1. Name of the Training: Quartz

2. Name of the Trainer: Arun

3. Students rating of Trainers: 9

S. No.	Date	Subject	Rating (√)			
			Excellent	Very good	Good	Average
1	9.12.18	Probability Percentage	✓			

4. Two positive points about the programme:

Training is very useful to understand the Quartz

5. Suggestions for improvement:

no suggestions

Date:

Ar. V. Vinethini
Signature



Name of the Student: Telavunabharathi

Branch: CSE

Year / Sem: IV / 7

4. Name of the Training: Infosys

5. Name of the Trainer: Sasireka

6. Students rating of Trainers:

S. No.	Date	Subject	Rating (√)			
			Excellent	Very good	Good	Average
1	9.12.18	Verbal Fill in the blanks Analogy	✓			

4. Two positive points about the programme:

Training is very useful to know the meaning of many words.

5. Suggestions for improvement:

no suggestions

PRINCIPAL
K. S. R. INSTITUTE FOR
ENGINEERING AND TECHNOLOGY,
K. S. R. KALVI NAGAR,
TIRUCHENGODE-637 215,
NAMAKKAL DI, TAMIL NADU.



Name of the Student: V. Kavi Praethi

Branch: ECE

Year / Sem: IV / VII

1. Name of the Training : George Verbal,

2. Name of the Trainer : George

3. Students rating of Trainers :

S. No.	Date	Subject	Rating (✓)			
			Excellent	Very good	Good	Average
1	11.12.18	Theme detection, Sentence correction, Sentence selection Error correction	✓			

4. Two positive points about the programme: Give more examples with good explanation

5. Suggestions for improvement:

Date: 11.12.2018

V. Kavi Praethi
Signature



Name of the Student: D. Sneha

Branch: IT

Year / Sem: IV / VII

1. Name of the Training : Quants

2. Name of the Trainer : George

3. Students rating of Trainers :

S. No.	Date	Subject	Rating (✓)			
			Excellent	Very good	Good	Average
1	11.12.2018	probability, Percentage, Time & speed	✓			

4. Two positive points about the programme: He is explained in detail all the topics

5. Suggestions for improvement:

Date: 11.12.2018

D. Sneha
Signature
PRINCIPAL,
K. S. R. INSTITUTE FOR
ENGINEERING AND TECHNOLOGY
K. S. R. KALVI NAGAR
TIRUCHENGODE - 637 215.
NAMAKKAL DL. TAMIL NADU.



Name of the Student: Gowri. p Branch: ECE

Year / Sem: IV / VII

1.Name of the Training : Infosys specific training

2.Name of the Trainer : ARUN

3.Students rating of Trainers : ARUN 5

S. No.	Date	Subject	Rating (√)			
			Excellent	Very good	Good	Average
1	11.12.18	Quants	✓			

4. Two positive points about the programme:

- ✓ He is very good to explain the methods.
- ✓ session was very interesting

5. Suggestions for improvement:

He want to cover other topics

Date: 11.12.18

Y. Srinivas
Signature



Name of the Student: Yogapriya Branch: FEE

Year / Sem: IV / VII

4.Name of the Training : Infosys specific Training

5.Name of the Trainer : ARUN

6.Students rating of Trainers : 5

S. No.	Date	Subject	Rating (√)			
			Excellent	Very good	Good	Average
1	11.12.18	Quants	✓			

4. Two positive points about the programme:

- 1) Effective clearing of doubts while discussion
- 2) session was so interactive & do more problems

5. Suggestions for improvement:

He may cover atleast 2 topics

PRINCIPAL,
K. S. R. INSTITUTE FOR
ENGINEERING AND TECHNOLOGY,
K. S. R. KALVIA,
TIRUCHENGODE,
NAMAKKAL DISTRICT.

Yogapriya
Signature

2. LANGUAGE AND COMMUNICATION SKILLS

K S R INSTITUTE FOR ENGINEERING AND TECHNOLOGY

LANGUAGE AND COMMUNICATION SKILLS CONSOLIDATED LIST

Academic Year:2018-2019

S.NO.	Name of the capability enhancement program	Date of implementation (DD-MM-YYYY)	Number of students enrolled	Name of the agencies/consultants involved with contact details (if any)
1	Internal Basic Communication Training	18.06.2018	360	KSRIET , placement@ksriet.ac.in
2	Advance Communication Skills Training	05.07.2018	340	KSRIET , placement@ksriet.ac.in
3	Essay writing	25.09.2018	38	KSRIET-Linga Club, hod_english@ksriet.ac.in
4	Slogan writing	25.09.2018	37	KSRIET-Linga Club, hod_english@ksriet.ac.in
5	Spell bee	16.02.2019	36	KSRIET-Linga Club, hod_english@ksriet.ac.in
6	Tongue twisters	16.02.2019	26	KSRIET-Linga Club, hod_english@ksriet.ac.in
7	JAM (just a minute)	02.03.2019	34	KSRIET-Linga Club, hod_english@ksriet.ac.in
8	Poem composing	02.03.2019	38	KSRIET-Linga Club, hod_english@ksriet.ac.in

PRINCIPAL

K. S. R. INSTITUTE FOR ENGINEERING AND TECHNOLOGY,
K. S. R. KALVI NAGAR,
TIRUCHENGODE - 637 215,
NAMAKKAL DI, TAMIL NADU.

Training Schedule [2018 - 2019] Odd Semester

Ref: KSRIET/T&P/CIR/2018-19

Date: 22.05.2018

This is to inform all the HoD's, Faculties & Department Training and Placement coordinators that the Internal Training for II year, III year & IV year PRP students on various topics for the academic year 2018 - 2019 (Odd Sem) has been scheduled. All the registered students should attend the Training Programme without fail. If any student skips this Training Programme without proper permission from the respective HoDs, he / she will not be permitted for any further Training Programme and campus recruitment process. Proper Dress Code is mandatory.

Encl.,

Detailed Training Schedule - Year Wise

T&P OFFICER

T&P COORDINATOR

PRINCIPAL

Copy to:

1. All HoDs
2. Notice Board

PRINCIPAL.
K. S. R. INSTITUTE FOR
ENGINEERING AND TECHNOLOGY,
K. S. R. KALVI NAGAR,
TIRUCHENGODE-637 215,
NAMAKKAL DI, TAMIL NADU.

K S R INSTITUTE FOR ENGINEERING AND TECHNOLOGY, TIRUCHENGODE - 637215
Training and Placement Cell

II Year Training Schedule [Odd Semester]

Batch: 2017-2021

Academic Year: 2018-2019

Branch	Day 1		Day 2		Day 3		Day 4		Day 5		Day 6	
	Date	Topics	Date	Topics	Date	Topics	Date	Topics	Date	Topics	Date	Topics
CSE	11.06.18	Basic Programming Skills in C	12.06.18	Basic Programming Skills in C	13.06.18	Basic Communication Skills	14.06.18	Basic Communication Skills	21.06.18	Basic Aptitude Skills	22.06.18	Basic Aptitude Skills
Faculty Name	CSE / IT Faculty		CSE / IT Faculty		Dr.C.Muhuntarajan HoD / English		Dr.C.Muhuntarajan HoD / English		Prof.M.S.Vijayaraj HoD / Maths		Prof.M.S.Vijayaraj HoD / Maths	
IT	11.06.18	Basic Programming Skills in C	12.06.18	Basic Programming Skills in C	13.06.18	Basic Aptitude Skills	14.06.18	Basic Aptitude Skills	25.06.18	Basic Communication Skills	26.06.18	Basic Communication Skills
Faculty Name	CSE / IT Faculty		CSE / IT Faculty		Prof.M.S.Vijayaraj HoD / Maths		Prof.M.S.Vijayaraj HoD / Maths		Dr.C.Muhuntarajan HoD / English		Dr.C.Muhuntarajan HoD / English	
EEE	11.06.18	Basic Programming Skills in C	12.06.18	Basic Programming Skills in C	21.06.18	Basic Communication Skills	22.06.18	Basic Communication Skills	25.06.18	Basic Aptitude Skills	26.06.18	Basic Aptitude Skills
Faculty Name	CSE / IT Faculty		CSE / IT Faculty		Dr.C.Muhuntarajan HoD / English		Dr.C.Muhuntarajan HoD / English		Prof.M.S.Vijayaraj HoD / Maths		Prof.M.S.Vijayaraj HoD / Maths	
ECE A	11.06.18	Basic Aptitude Skills	12.06.18	Basic Aptitude Skills	18.06.18	Basic Programming Skills in C	19.06.18	Basic Programming Skills in C	28.06.18	Basic Communication Skills	29.06.18	Basic Communication Skills
Faculty Name	Prof.M.S.Vijayaraj HoD / Maths		Prof.M.S.Vijayaraj HoD / Maths		CSE / IT Faculty		CSE / IT Faculty		Dr.C.Muhuntarajan HoD / English		Dr.C.Muhuntarajan HoD / English	
ECE B	11.06.18	Basic Communication Skills	12.06.18	Basic Communication Skills	18.06.18	Basic Programming Skills in C	19.06.18	Basic Programming Skills in C	28.06.18	Basic Aptitude Skills	29.06.18	Basic Aptitude Skills
Faculty Name	Dr.C.Muhuntarajan HoD / English		Dr.C.Muhuntarajan HoD / English		CSE / IT Faculty		CSE / IT Faculty		Prof.M.S.Vijayaraj HoD / Maths		Prof.M.S.Vijayaraj HoD / Maths	

PRINCIPAL.
K. S. R. INSTITUTE FOR ENGINEERING AND TECHNOLOGY,
K. S. R. KALVI NAGAR,
TIRUCHENGODE-637 215,
 NAMAKKAL Dt. TAMIL NADU.

Branch	Day 1		Day 2		Day 3		Day 4		Day 5		Day 6	
	Date	Topics	Date	Topics	Date	Topics	Date	Topics	Date	Topics	Date	Topics
MEC A	13.06.18	Basic Programming Skills in C	14.06.18	Basic Programming Skills in C	18.06.18	Basic Aptitude Skills	19.06.18	Basic Aptitude Skills	02.07.18	Basic Communication Skills	03.07.18	Basic Communication Skills
Faculty Name	CSE / IT Faculty		CSE / IT Faculty		Prof.M.S.Vijayaraj Hod / Maths		Prof.M.S.Vijayaraj Hod / Maths		Dr.C.Muhuntarajan Hod / English		Dr.C.Muhuntarajan Hod / English	
MEC B	13.06.18	Basic Programming Skills in C	14.06.18	Basic Programming Skills in C	18.06.18	Basic Communication Skills	19.06.18	Basic Communication Skills	02.07.18	Basic Aptitude Skills	03.07.18	Basic Aptitude Skills
Faculty Name	CSE / IT Faculty		CSE / IT Faculty		Dr.C.Muhuntarajan Hod / English		Dr.C.Muhuntarajan Hod / English		Prof.M.S.Vijayaraj Hod / Maths		Prof.M.S.Vijayaraj Hod / Maths	

F. S. Srinivasan
F & P OFFICER

[Signature]
I & P COORDINATOR

[Signature]
PRINCIPAL

PRINCIPAL,
K. S. R. INSTITUTE FOR
ENGINEERING AND TECHNOLOGY,
K. S. R. KALVI NAGAR,
TIRUCHENGODE-637 215,
NAMAKKAL Dt. TAMIL NADU.

Training Topics			Aptitude Skills				Programming Skills in C				Communication Skills			
Trainer			Prof.M.S.Vijayaraj HoD/Maths				D. Balakrishnan AP/IT				Dr.C.Muhuntarajan HoD/Eng			
Trainng Date			11.06.18		12.06.18		18.06.18		19.06.18		28.06.18		29.06.18	
S. No		Name	FN	AN	FN	AN	FN	AN	FN	AN	FN	AN	FN	AN
1	731617106001	AARTHI G	a	a	a				DC					
2	731617106002	ABINAYA T	l	l	a	a	a	a	l	l	l	l	l	l
3	731617106003	ALKA P	a	a	l	l	l	l	l	l	l	l	l	l
4	731617106004	ANBAZHAGAN K	l	l	l	l	l	l	l	l	l	l	l	l
5	731617106005	ASHWINKUMAR V	←-----→				Discontinue				←-----→			
6	731617106006	BALAKUMARAN N	l	l	l	l	l	l	l	l	l	l	l	l
7	731617106007	BOOMA V	l	l	l	l	l	l	l	l	l	l	l	l
8	731617106008	DARANIDARAN R S	l	l	l	l	l	l	l	l	l	l	l	l
9	731617106009	DEEPA R	←-----→				DC				←-----→			
10	731617106010	DHANISH V	l	l	l	l	l	l	l	l	l	l	l	l
11	731617106011	DHANUSHKODI N	l	l	l	l	l	l	l	l	l	l	l	l
12	731617106012	DHARNISH K	l	l	l	l	l	l	l	l	l	l	l	l
13	731617106013	DHARSHAN T K	l	l	l	l	l	l	l	l	l	l	l	l
14	731617106014	DINESH U G	a	a	l	l	l	l	a	a	l	l	l	l
15	731617106015	DINNESH P	l	l	l	l	l	l	l	l	l	l	l	l
16	731617106016	GEETHARANI G	l	l	l	l	l	l	l	l	l	l	l	l
17	731617106017	GOKULNATH N	l	l	l	l	l	l	l	l	l	l	l	l
18	731617106018	GOKULNATH R	l	l	l	l	l	l	l	l	l	l	l	l
19	731617106019	GOWTHAM M	l	l	a	a	l	l	l	l	l	l	l	l
20	731617106020	HARI HARA SUDHAN R	l	l	l	l	l	l	l	l	l	l	l	l
21	731617106021	HARIKRISHNAN M	a	a	l	l	l	l	l	l	l	l	l	l
22	731617106022	HARISHKUMAR R	l	l	l	l	l	l	l	l	l	l	l	l
23	731617106023	HEMAHARINI S	l	l	l	l	l	l	l	l	l	l	l	l
24	731617106024	HEMALATHA S	a	a	l	l	l	l	l	l	l	l	l	l
25	731617106025	JANARTH S	l	l	l	l	l	l	l	l	l	l	l	l
26	731617106026	JANARTHANAN D	←-----→				DC				←-----→			
27	731617106027	JAWAHAR RAJA P	l	l	l	l	l	l	l	l	l	l	l	l
28	731617106028	KAMALESHWARAN R	a	a	l	l	l	l	l	l	l	l	l	l
29	731617106029	KAMALINI N	l	l	l	l	l	l	l	l	l	l	l	l
30	731617106030	KARTHIKA C	l	l	a	a	l	l	l	l	l	l	l	l
31	731617106031	KEERTHANA S	l	l	l	l	l	l	l	l	l	l	l	l
32	731617106032	KEERTHIVASAN N	a	a	l	l	l	l	l	l	l	l	l	l
33	731617106033	KISHOR M	a	a	l	l	l	l	l	l	l	l	l	l

PRINCIPAL.
K. S. R. INSTITUTE FOR
ENGINEERING AND TECHNOLOGY,
K. S. R. KALVI NAGAR,
TIRUCHENGODE-637 215,
NAMAKKAL DI, TAMIL NADU.

Trainng Date			11.06.18		12.06.18		18.06.18		19.06.18		28.06.18		29.06.18	
S. No		Name	FN	AN	FN	AN	FN	AN	FN	AN	FN	AN	FN	AN
34	731617106034	KISHORE D	/	/	/	/	/	/	/	/	/	/	/	/
35	731617106035	LAKSHMANAN S	/	/	/	/	/	/	/	/	/	/	/	/
36	731617106036	MADHANGOPAL C	/	/	a	a	/	/	/	/	/	/	a	a
37	731617106037	MANIMALA R	/	/	/	/	/	/	/	/	/	/	/	/
38	731617106038	MANJULA T	/	/	/	/	/	/	a	a	/	/	/	/
39	731617106039	MERINKUMAR L	/	/	/	/	/	/	/	/	/	/	/	/
40	731617106040	MUSHIDHA SIFANA T	/	/	/	/	/	/	/	/	/	/	/	/
41	731617106041	MUTHULAKSHMI S	a	a	/	/	/	/	/	/	/	/	/	/
PRESENT														
ABSENT														
PERMISSION														
OD														

PRINCIPAL.
K. S. R. INSTITUTE FOR
ENGINEERING AND TECHNOLOGY,
K. S. R. KALVI NAGAR,
TIRUCHENGODE-637 215,
NAMAKKAL Dt, TAMIL NADU.

Training Topics			Programming Skills in C				Aptitude Skills				Communication Skills			
Trainer			S Nandagopal AP/IT				Prof.M.S.Vijayaraj HoD/Maths				Dr.C.Muhuntarajan HoD/Eng			
Trainng Date			11.06.18		12.06.18		13.06.18		14.06.18		25.06.18		26.06.18	
S. No	Reg No	Name	FN	AN	FN	AN	FN	AN	FN	AN	FN	AN	FN	AN
1	731617205001	AJAY SRIRAM K	a	a	/	/	/	/	a	a	/	/	/	/
2	731617205002	ARULMOZHI M	/	/	/	/	/	/	/	/	/	/	/	/
3	731617205003	BABU U S	/	/	/	/	/	/	/	/	/	/	/	/
4	731617205004	BALAMURUGAN S	/	/	/	/	/	/	/	/	/	/	/	/
5	731617205005	CHANDRU M	/	/	/	/	/	/	/	/	/	/	/	/
6	731617205006	DHANUSH ADIT R	/	/	/	/	/	/	/	/	/	/	/	/
7	731617205007	DHINAKARAN B	/	/	/	/	/	/	/	/	/	/	/	/
8	731617205008	DINESH KUMAR P	/	/	/	/	/	/	/	/	/	/	/	/
9	731617205009	DIVYA P	a	a	a	a	a	a	a	a	a	a	a	a
10	731617205010	GIRINATH S	/	/	/	/	/	/	/	/	/	/	/	/
11	731617205011	GOBIKA M	a	a	/	/	/	/	/	/	/	/	/	/
12	731617205012	GOKULAN S	/	/	/	/	/	/	/	/	/	/	/	/
13	731617205013	HARIPRASATH K	/	/	/	/	/	/	a	a	/	/	/	/
14	731617205014	JESSICA COLLINS J P	/	/	/	/	/	/	/	/	/	/	/	/
15	731617205015	JOSHUA DANIEL B	/	/	/	/	/	/	/	/	/	/	/	/
16	731617205016	JOTHEESWARAN R	/	/	/	/	/	/	/	/	/	/	/	/
17	731617205017	KALAI KANNAN S	a	a	a	a	a	a	a	a	a	a	a	a
18	731617205018	KALIDASS R	/	/	/	/	/	/	/	/	/	/	/	/
19	731617205019	KANNAN P	/	/	/	/	/	/	a	/	/	/	/	/
20	731617205021	KARTHIK T	a	a	/	/	/	/	a	a	/	/	/	/
21	731617205022	KARTHIKEYAN M	/	/	/	/	/	/	/	/	/	/	/	/
22	731617205023	KAVIN I G	a	a	a	a	a	a	a	a	a	a	a	a
23	731617205024	KEERTHIVARMA K S	/	/	/	/	/	/	/	/	/	/	/	/
24	731617205025	LAKSHMANAN R	/	/	/	/	/	/	/	/	/	/	/	/
25	731617205026	MANIKANDAN A	/	/	/	/	/	/	a	a	/	/	/	/
26	731617205027	MOUNISH G	a	a	/	/	/	/	/	/	/	/	/	/
27	731617205028	MUKESH KANNA R	/	/	/	/	/	/	/	/	/	/	/	/
28	731617205029	MUKESHKANNAN T	a	a	a	a	a	a	a	a	a	a	a	a
29	731617205030	NANDHINI S	/	/	/	/	/	/	/	/	/	/	/	/
30	731617205031	NATHIYA V	/	/	/	/	/	/	/	/	/	/	/	/
31	731617205032	NAVEEN KUMAR G (30-12-1999)	/	/	/	/	/	/	a	a	/	/	/	/
32	731617205033	NAVEEN KUMAR G (14-06-2000)	a	a	/	/	/	/	/	/	/	/	/	/
33	731617205034	NIRMAL KUMAR S	/	/	/	/	/	/	/	/	/	/	/	/
34	731617205035	PAVITHRA S	/	/	/	/	/	/	a	a	/	/	a	a

PRINCIPAL,
K. S. R. INSTITUTE FOR
ENGINEERING AND TECHNOLOGY,
K. S. R. KALVI NAGAR,
TIRUCHENGODE-637 215,
NAMAKKAL Dt, TAMIL NADU.

Training Date			11.06.18		12.06.18		13.06.18		14.06.18		25.06.18		26.06.18	
S. No	Reg No	Name	FN	AN	FN	AN	FN	AN	FN	AN	FN	AN	FN	AN
35	731617205036	PRIYADHARSHINI P	/	/	/	/	a	a	a	a	a	a	/	/
36	731617205037	RAGU G	a	a	/	/	/	/	/	/	/	/	/	/
37	731617205038	RAJARAVEENDHAR G R	/	/	/	/	/	/	a	a	/	/	/	/
38	731617205039	SAANTHOSHBALAJI S N	/	/	a	a	/	/	/	/	/	/	/	/
39	731617205040	SANDHIYA G	/	/	/	/	/	/	/	/	/	/	/	/
40	731617205041	SANTHOSH KUMAR R	/	/	/	/	/	/	/	/	a	a	/	/
41	731617205042	SARAN V	/	/	/	/	/	/	/	/	a	a	/	/
42	731617205043	SATHAM M	/	/	/	/	/	/	/	/	/	/	/	/
43	731617205044	SATHISHKUMAR V	/	/	a	a	/	/	/	/	/	/	/	/
44	731617205045	SELVAMALAR P	/	/	/	/	a	a	/	/	/	/	/	/
45	731617205046	SHAILAA P M	/	/	/	/	/	/	a	a	/	/	/	/
46	731617205047	SHIVANI N	a	a	/	/	/	/	/	/	a	a	/	/
47	731617205048	SIVASANKARI R	/	/	/	/	/	/	/	/	/	/	/	/
48	731617205049	SREEMATHI INDRA S	/	/	/	/	a	a	a	a	/	/	/	/
49	731617205050	SRIRAM S	/	/	a	a	/	/	/	/	/	/	/	/
50	731617205051	THANESSHWARAN Y G	/	/	/	/	/	/	/	/	/	/	/	/
51	731617205052	THUSMEENA K R	/	/	/	/	/	/	/	/	a	/	/	/
52	731617205053	VENKATESHWARAN S	/	/	/	/	a	a	a	a	/	/	/	/
53	731617205054	VIMALRAJ G	/	/	a	a	/	/	/	/	/	/	/	/
54	731617205055	VINOTHINI R	/	/	/	/	/	/	/	/	/	/	/	/
PRESENT														
ABSENT														
PERMISSION														
OD														

PRINCIPAL,
K. S. R. INSTITUTE FOR
ENGINEERING AND TECHNOLOGY,
K. S. R. KALVI NAGAR
TIRUCHENGAI
NAIDIVELU-605 006

Training Topics			Programming Skills in C				Aptitude Skills				Communication Skills			
Trainer			Prakasam AP/CSE				Prof.M.S.Vijayaraj HoD/Maths				Dr.C.Muhuntarajan HoD/Eng			
Training Date			13.06.18		14.06.18		18.06.18		19.06.18		02.07.18		03.07.18	
S. No	Reg No	Name	FN	AN	FN	AN	FN	AN	FN	AN	FN	AN	FN	AN
1	731617114001	AADHI VISHWANATH M	/	/	/	/	/	/	/	/	/	/	/	/
2	731617114002	AJITH R	/	/	/	/	/	/	/	/	/	/	/	/
3	731617114003	ARAVIND S R	/	/	/	/	/	/	/	/	/	/	/	/
4	731617114004	ARUNESH J	/	/	/	/	/	/	/	/	/	/	/	/
5	731617114005	ARUN KUMAR S	/	/	/	/	/	/	/	/	/	/	/	/
6	731617114006	ARUN KUMAR T	/	/	/	/	/	/	/	/	/	/	/	/
7	731617114007	ARUN PRABAKARAN J	/	/	/	/	/	/	/	/	/	/	/	/
8	731617114008	ASWANTH KUMAR K	/	/	/	/	/	/	/	/	/	/	/	/
9	731617114009	ASWIN M	/	/	/	/	/	/	/	/	/	/	/	/
10	731617114010	BALAJI S	/	/	/	/	/	/	/	/	/	/	/	/
11	731617114011	BHAGAVATHI PERUMAL G	/	/	/	/	/	/	/	/	/	/	/	/
12	731617114012	BHARANIDHARAN R	/	/	/	/	/	/	/	/	/	/	/	/
13	731617114013	BOOPATHI S	/	/	/	/	/	/	/	/	/	/	/	/
14	731617114014	BOOPATHIRAJA M	/	/	/	/	/	/	/	/	/	/	/	/
15	731617114015	BUVANESVARAN S	/	/	/	/	/	/	/	/	/	/	/	/
16	731617114016	CHANDRU K	/	/	/	/	/	/	/	/	/	/	/	/
17	731617114017	CHANDRU M	/	/	/	/	/	/	/	/	/	/	/	/
18	731617114018	CHANDRU S	/	/	/	/	/	/	/	/	/	/	/	/
19	731617114019	DEEPAK K	/	/	/	/	/	/	/	/	/	/	/	/
20	731617114020	DHARANKUMAR S	/	/	/	/	/	/	/	/	/	/	/	/
21	731617114021	DHARSHAN C M	/	/	/	/	/	/	/	/	/	/	/	/
22	731617114022	DINESHKUMAR D	/	/	/	/	/	/	/	/	/	/	/	/
23	731617114023	DINESHKUMAR R	/	/	/	/	/	/	/	/	/	/	/	/
24	731617114024	DIVAGAR S (Discontinue)	/	/	/	/	/	/	/	/	/	/	/	/
25	731617114026	GOBIRAJ R	/	/	/	/	/	/	/	/	/	/	/	/
26	731617114027	GOKULNATH K	/	/	/	/	/	/	/	/	/	/	/	/
27	731617114028	GOKULPRASANTH M	/	/	/	/	/	/	/	/	/	/	/	/
28	731617114029	GOKULRAJ B	/	/	/	/	/	/	/	/	/	/	/	/
29	731617114030	GOVINDHARASU R	/	/	/	/	/	/	/	/	/	/	/	/
30	731617114031	GOWTHAM KUMAR T	/	/	/	/	/	/	/	/	/	/	/	/
31	731617114032	GUNASEELAN C	/	/	/	/	/	/	/	/	/	/	/	/
32	731617114033	HARIHARAN G	/	/	/	/	/	/	/	/	/	/	/	/
33	731617114034	HARIHARAN PR	/	/	/	/	/	/	/	/	/	/	/	/
34	731617114035	HARIPRASATH P	/	/	/	/	/	/	/	/	/	/	/	/

PRINCIPAL.

K. S. R. INSTITUTE FOR
ENGINEERING AND TECHNOLOGY,

K. S. R. KALVI NAGAR,

TIRUCHENGODE-637 215,

TAMIL NADU.

Training Date			13.06.18		14.06.18		18.06.18		19.06.18		02.07.18		03.07.18	
S. No	Reg No	Name	FN	AN	FN	AN	FN	AN	FN	AN	FN	AN	FN	AN
35	731617114036	HARIRAM B	/	/	/	/	/	/	/	/	/	/	/	/
36	731617114037	INDIRAJITH M	/	/	/	/	/	/	/	/	/	/	/	/
37	731617114038	JAGATHESHWARAN N	/	/	a	a	/	/	/	/	/	/	/	/
38	731617114039	KAMALESH T	/	/	/	/	/	/	/	/	/	/	/	/
39	731617114040	KARTHICK R	/	/	/	/	/	/	/	/	/	/	/	/
40	731617114041	KARTHIK A S	/	/	/	/	/	/	/	/	/	/	/	/
41	731617114042	KARTHIKEYAN S	/	/	/	/	/	/	/	/	/	/	/	/
42	731617114043	KARTHIKEYAN T	/	/	/	/	/	/	/	/	/	/	/	/
43	731617114044	KARUPPAIAH K	/	/	/	/	/	/	/	/	/	/	/	/
44	731617114045	KATHIRVEL M	/	/	/	/	/	/	/	/	/	/	/	/
45	731617114046	KAVIN M	/	/	/	/	/	/	/	/	/	/	/	/
46	731617114047	KAVIN M	/	/	/	/	/	/	/	/	/	/	/	/
47	731617114048	KAVINKUMAR C	/	/	/	/	/	/	/	/	/	/	/	/
48	731617114049	KAVIRAJ M	/	/	/	/	/	/	/	/	/	/	/	/
49	731617114050	KIRUBAKARAN K	/	/	/	/	/	/	/	/	/	/	/	/
50	731617114051	KIRUBAKARAN K	/	/	/	/	/	/	/	/	/	/	/	/
51	731617114052	LOGESH M	/	/	/	/	/	/	/	/	/	/	/	/
52	731617114053	MADESH K	/	/	/	/	/	/	/	/	/	/	/	/
53	731617114054	MANIKANDAN R	/	/	/	/	/	/	/	/	/	/	/	/
54	731617114055	MANOJ N	/	/	/	/	/	/	/	/	/	/	/	/
55	731617114056	MEIYANANDHAN V	/	/	/	/	/	/	/	/	/	/	/	/
56	731617114057	MOHAMED ABBAS M	/	/	/	/	/	/	/	/	/	/	/	/
PRESENT			54	54	50	50	/	/	55	55	54	54	52	52
ABSENT			1	1	3	3	0	0	0	0	1	1	-	-
PERMISSION			0	0	0	0	0	0	-	-	-	-	3	3
OD			0	0	0	0	-	-	-	-	-	-	-	-

PRINCIPAL,
K. S. R. INSTITUTE FOR
ENGINEERING AND TECHNOLOGY,
K. S. R. KALVI NAGAR,
TIRUCHENGODE-637 215,
NAMAKKAL DL, TAMIL NADU.

Training and Placement Cell

CSE - Internal Basic Communication, Aptitude & Programming In C Training Attendance

BATCH : 2017 - 2021

Academic Year: 2018 - 2019

Training Topics			Programming Skills in C				Communication Skills				Aptitude Skills			
Trainer			Sharmila AP/CSE				Dr.C.Muhuntarajan HoD/English				Prof.M.S.Vijayaraj HoD/Maths			
Training Date			11.06.18		12.06.18		9.06.18 13.06.18		10.06.18 14.06.18		21.06.18		22.06.18	
S. No	Reg No	Name	FN	AN	FN	AN	FN	AN	FN	AN	FN	AN	FN	AN
1	731617104001	ABINAYA S	a	a	l	l	l	l	l	l	l	l	l	l
2	731617104002	AGILAN R	a	a	l	l	l	l	l	l	l	l	l	l
3	731617104003	AKKIRAJU-SAI-CHARAN	a	a	l	l	l	l	l	l	l	l	l	l
4	731617104004	ARUN KUMAR N	l	l	a	a	l	l	l	l	l	l	a	a
5	731617104005	BABU R	l	l	l	l	a	a	l	l	a	a	l	l
6	731617104006	BOOPALAN V	a	a	l	l	l	l	l	l	l	l	l	l
7	731617104007	CHOWMIYA S B	l	l	a	a	l	l	l	l	l	l	a	a
8	731617104008	DEEPAK KUMAR J	a	a	l	l	l	l	l	l	a	a	l	l
9	731617104009	DERIL CHARLESS K	l	l	l	l	a	a	l	l	l	l	l	l
10	731617104010	DHARSHINI P	l	l	a	a	l	l	l	l	l	l	l	l
11	731617104011	DINESHKUMAR K (03-11-1999)	l	l	l	l	l	l	l	l	l	l	l	l
12	731617104012	DINESHKUMAR K (25-02-2000)	l	l	l	l	l	l	a	a	l	l	l	l
13	731617104013	ELANGO M	l	l	l	l	l	l	l	l	l	l	l	l
14	731617104014	GAYATHIRI M (19-05-2000)	a	a	l	l	l	l	l	l	l	l	l	l
15	731617104015	GAYATHIRI M (19-10-2000)	l	l	a	a	l	l	l	l	l	l	l	l
16	731617104016	GOWTHAM G	l	l	l	l	l	l	a	a	a	a	l	l
17	731617104017	GUNA M	a	a	l	l	l	l	l	l	l	l	l	l
18	731617104018	HARIHARAN S	l	l	l	l	a	a	l	l	l	l	a	a
19	731617104019	HARI KUMAR S	a	a	a	a	l	l	l	l	l	l	l	l
20	731617104020	HARISH P	l	l	l	l	l	l	l	l	a	a	l	l
21	731617104021	KAILASH K	l	l	l	l	l	l	a	a	l	l	l	l
22	731617104022	KARTHIKEYAN S	a	a	l	l	l	l	l	l	l	l	l	l
23	731617104023	KESAVAN S	l	l	a	a	l	l	l	l	l	l	l	l
24	731617104024	KISHOR P	l	l	l	l	l	l	l	l	l	l	a	a
25	731617104025	KOTEESHWARAN P N	a	a	l	l	l	l	l	l	l	l	l	l
26	731617104026	KRISHNAMOORTHY S	l	l	l	l	l	l	l	l	a	a	l	l
27	731617104027	MANORANJITH M	l	l	a	a	l	l	l	l	l	l	l	l
28	731617104028	MARIMUTHU R	a	a	a	a	l	l	l	l	l	l	l	l
29	731617104029	MENAGA T	l	l	l	l	a	a	l	l	l	l	l	l
30	731617104030	MOHAMED ABI VAKAAS S	l	a	l	l	l	l	l	l	l	l	l	l
31	731617104031	MOHANAPREYA N	a	a	l	l	l	l	l	l	l	l	l	l
32	731617104032	MONISH D	a	a	l	l	l	l	l	l	l	l	l	l
33	731617104033	MURALIDHARAN A	l	l	a	a	l	l	l	l	l	l	l	l
34	731617104034	POOJA M	l	l	l	l	l	l	l	l	l	l	a	a

PRINCIPAL,
K. S. R. INSTITUTE FOR
ENGINEERING AND TECHNOLOGY,
K. S. R. KALVI NAGAR,
TIRUCHENGODE-637 215,
NAMAKKAL Dt, TAMIL NADU.

Trainng Date			11.06.18		12.06.18		13.06.18		14.06.18		21.06.18		22.06.18	
S. No	Reg No	Name	FN	AN	FN	AN	FN	AN	FN	AN	FN	AN	FN	AN
35	731617104035	POOJA SHREE K	/	a	a	a	/	/	/	/	/	/	/	/
36	731617104036	POOVARASAN S	/	/	/	/	/	/	a	a	/	/	/	/
37	731617104037	PRAKASH V	/	a	/	/	/	/	/	/	/	/	/	/
38	731617104038	PRASANTH N	/	/	a	a	/	/	/	/	a	a	/	/
39	731617104039	PRASANTH T	/	/	/	/	/	/	/	/	/	/	/	/
40	731617104040	PURUSOTHAMAN R	a	a	/	/	/	/	/	/	/	/	/	/
41	731617104041	RAJA SARAVANAN N S	/	/	/	/	/	/	/	/	a	a	/	/
42	731617104042	SANGEETHA M	/	/	a	a	/	/	/	/	/	/	/	/
43	731617104043	SANTHOSHKUMAR A	a	a	/	/	/	/	/	/	/	/	/	/
44	731617104044	SATHEESHKUMAR THANGAVEL	/	/	/	/	a	a	/	/	/	/	/	/
45	731617104045	SHARMILA A	/	/	a	a	/	/	/	/	/	/	a	a
46	731617104046	SNEHA P	a	a	/	/	/	/	/	/	/	/	/	/
47	731617104047	SOUNDHAR P	/	/	/	/	/	/	/	/	a	a	/	/
48	731617104048	SURYA K	/	/	/	/	/	/	/	/	/	/	/	/
49	731617104049	TAMILARASU K	Discontinue											
50	731617104050	VAISHNAVI V	/	/	/	/	/	/	a	a	/	/	/	/
51	731617104051	VALENTEENA COLLINS J P	a	a	/	/	/	/	/	/	/	/	/	/
52	731617104052	VEERALAKSHMI S	/	/	/	/	/	/	/	/	/	/	/	/
53	731617104053	VIGNESH M	/	/	a	a	/	/	/	/	/	/	/	/
54	731617104054	VIGNESH S	a	a	/	/	/	/	/	/	/	/	/	/
55	731617104055	VIJAY S	/	/	/	/	/	/	/	/	a	a	/	/
56	731617104057	YOKESH E	/	/	/	/	/	/	/	/	/	/	a	a
57	731617104058	YUVASHREE R	/	/	a	a	/	/	/	/	/	/	/	/
PRESENT														
ABSENT														
PERMISSION														
OD														

PRINCIPAL.
K. S. R. INSTITUTE FOR
ENGINEERING AND TECHNOLOGY,
K. S. R. KALVI NAGAR,
TIRUCHENGODE-637 215,
NAMAKKAL DI, TAMIL NADU.

K S R INSTITUTE FOR ENGINEERING AND TECHNOLOGY, Tiruchengode

Training and Placement Cell

EEE - Internal Basic Communication, Aptitude & Programming In C Training Attendance

BATCH : 2017 - 2021

Academic Year: 2018 - 2019

Training Topics			Programming Skills in C				Communication Skills				Aptitude Skills			
Trainer			D. Balakrishnan AP/IT				Dr.C.Muhuntarajan HoD/Eng				Prof.M.S.Vijayaraj HoD/Maths			
Trainng Date			11.06.18		12.06.18		21.06.18		22.06.18		25.06.18		26.06.18	
S. No	Reg No	Name	FN	AN	FN	AN	FN	AN	FN	AN	FN	AN	FN	AN
1	731617105001	ARUL M	/	/	/	/	/	/	/	/	/	/	/	/
2	731617105002	ASHA R	a	/	a	a	/	/	/	/	/	/	/	/
3	731617105003	BALAJI S	/	/	/	/	a	a	/	/	/	/	/	/
4	731617105004	BHARATH S	/	/	a	a	/	/	/	/	/	/	/	/
5	731617105005	DINESH C	a	a	/	/	/	/	/	/	/	/	/	/
6	731617105006	DINESH KUMAR T	/	/	/	/	/	/	/	/	/	/	/	/
7	731617105007	EZHILAN T	a	a	a	a								
8	731617105008	GOWTHAM S P	/	/	/	/	/	/	/	/	/	/	/	/
9	731617105009	GUGANESH R	/	/	/	/	/	/	/	/	/	/	/	/
10	731617105010	HARI S R	a	a	/	/	a	a	/	/	/	/	/	/
11	731617105011	HEMALATHA S	/	/	a	a	/	/	a	a	/	/	/	/
12	731617105012	JAYASURYA K	/	/	/	/	/	/	/	/	/	/	/	/
13	731617105013	JEEVANANDAM T	a	a	/	/	/	/	/	/	/	/	/	/
14	731617105014	JEEVITHA G	/	/	/	/	/	/	a	a	/	/	/	/
15	731617105015	JEGATHKUMAR S	/	/	/	/	/	/	/	/	/	/	/	/
16	731617105016	KAMALAHASAN G	/	/	/	/	/	/	/	/	/	/	/	/
17	731617105017	KARTHIKEYAN M	/	/	a	a	/	/	a	a	/	/	/	/
18	731617105018	KAVINKUMAR M	/	/	/	/	/	/	/	/	/	/	/	/
19	731617105019	KAVIN MUTHU KUMAR S	a	a	/	/	/	/	/	/	/	/	/	/
20	731617105020	KIRUBAKAR S	/	/	/	/	/	/	/	/	/	/	/	/
21	731617105021	LOGESWARAN C	/	/	a	a	/	/	/	/	/	/	/	/
22	731617105022	MANJUPRIYA M	/	/	/	/	/	/	/	/	a	a	/	/
23	731617105023	MANOJ KUMAR S	/	/	/	/	/	/	/	/	/	/	/	/
24	731617105024	MOHAN T	a	a	/	/	/	/	/	/	a	a	/	/
25	731617105025	NANDAKUMAARAN S	/	/	/	/	/	/	/	/	/	/	/	/
26	731617105027	PARAMASIVAM R	/	/	a	a	/	/	/	/	/	/	/	/
27	731617105028	PERARIVU EZHIL ARASAN T	/	/	/	/	/	/	/	/	/	/	/	/
28	731617105029	POOVARASAN J	/	/	a	a	/	/	/	/	/	/	/	/
29	731617105030	PRASATH S	a	a	a	a	a	a	a	a	a	a	a	a
30	731617105031	PRAVEEN KUMAR A	/	/	/	/	/	/	/	/	/	/	/	/
31	731617105032	PRAVEEN KUMAR M	/	/	/	/	/	/	/	/	/	/	/	/
32	731617105033	RAJAT KUMAR	a	a	a	a	/	/	a	a	/	/	/	/
33	731617105034	RAMYA A	/	/	/	/	/	/	/	/	/	/	/	/
34	731617105035	RAMYA P	/	/	/	/	/	/	/	/	/	/	/	/

PRINCIPAL.
K. S. R. INSTITUTE FOR
ENGINEERING AND TECHNOLOGY,
K. S. R. KALVI NAGAR,
TIRUCHENGODE-637 215,
NAMAKKAL Dt, TAMIL NADU.

Training Date			11.06.18		12.06.18		21.06.18		22.06.18		25.06.18		26.06.18	
S.No	Reg No	Name	FN	AN	FN	AN	FN	AN	FN	AN	FN	AN	FN	AN
35	731617105036	SAKTHIVEL P	/	/	/	/	/	/	/	/	/	/	/	/
36	731617105037	SANTHOSHKUMAR K	/	/	/	/	/	/	/	/	/	/	a	a
37	731617105038	SARANSARVESH M	/	/	/	/	/	/	/	/	/	/	/	/
38	731617105040	SASIKUMAR C	/	/	/	/	/	/	/	/	/	/	/	/
39	731617105041	SELVAM B	/	/	a	/	/	/	/	/	/	/	a	a
40	731617105042	SHAMEER S	/	/	/	/	/	/	/	/	/	/	/	/
41	731617105043	SHARMILAPRIYA S	/	/	/	/	/	/	/	/	/	/	/	/
42	731617105044	SHYAM PRASHAD S	/	/	/	/	/	/	/	/	/	/	/	/
43	731617105045	SILAMBARASAN S	a	a	/	/	/	/	/	/	/	/	/	/
44	731617105046	SUJITH S (11-02-2000)	/	/	/	/	/	/	/	/	/	/	a	a
45	731617105047	SUJITH S (11-07-2000)	/	/	/	/	/	/	/	/	/	/	/	/
46	731617105048	SUPIYA K	/	/	/	/	/	/	/	/	/	/	/	/
47	731617105049	SURESH P	/	/	a	/	/	/	/	/	/	/	a	a
48	731617105050	SURYA P	/	/	/	/	/	/	/	/	/	/	/	/
49	731617105052	THAMIZHSELVAN R	/	/	/	/	/	/	/	/	/	/	a	a
50	731617105053	VALLARASU S	/	/	a	a	/	/	/	/	/	/	/	/
51	731617105054	VENKATESAN M	/	/	/	/	/	/	/	/	/	/	/	/
52	731617105055	VINOTH KUMAR R	/	/	/	/	/	/	/	/	/	/	/	/
PRESENT														
ABSENT														
PERMISSION														
OD														
NOT INTEREST														

PRINCIPAL,
K. S. R. INSTITUTE FOR
ENGINEERING AND TECHNOLOGY
K. S. R. KALVI NAGAR,
TIRUCHENGODE-637 215,
NAMAKKAL Dt. TAMIL NADU.

K S R INSTITUTE FOR ENGINEERING AND TECHNOLOGY, Tiruchengode

Training and Placement Cell

ECE B - Internal Basic Communication, Aptitude & Programming In C Training Attendance

BATCH : 2017 - 2021

Academic Year: 2018 - 2019

Training Topics			Communication Skills				Programming Skills in C				Aptitude Skills			
Trainer			Dr.C.Muhuntarajan HoD/Eng				K G Lavanya AP/IT				Prof.M.S.Vijayaraj HoD/Maths			
Trainng Date			11.06.18		02.06.18		18.06.18		19.06.18		28.06.18		29.06.18	
S. No		Name	FN	AN	FN	AN	FN	AN	FN	AN	FN	AN	FN	AN
1	731617106042	NAVEEN L	/	/	/	/	/	/	/	/	/	/	/	/
2	731617106043	NAVEEN S S	/	/	/	/	/	/	/	/	/	/	a	a
3	731617106045	PARKAVI P	/	/	/	/	/	/	/	/	/	/	/	/
4	731617106046	PARKAVI S	/	/	/	/	/	/	/	/	/	/	/	/
5	731617106047	PAVITHRA T	/	/	/	/	/	/	/	/	/	/	/	/
6	731617106048	PREMELA R	/	/	/	/	/	/	/	/	/	/	/	/
7	731617106049	PRIYA R	/	/	/	/	/	/	a	a	/	/	/	/
8	731617106050	PRIYANKA V	a	a	/	/	/	/	/	/	/	/	/	/
9	731617106051	RAGHURAMACHANDIRAN V	/	/	/	/	/	/	/	/	/	/	/	/
10	731617106052	RAMYA S	/	/	/	/	/	/	/	/	/	/	/	/
11	731617106053	RANJITH M	/	/	/	/	/	/	/	/	/	/	/	/
12	731617106054	RESHMA K	/	/	/	/	a	a	/	/	/	/	/	/
13	731617106055	RUBAN PRASAD J	/	/	/	/	/	/	/	/	/	/	/	/
14	731617106056	SANDHIYA K	/	/	/	/	/	/	/	/	a	a	/	/
15	731617106057	SANTHIYA T	/	/	/	/	/	/	/	/	/	/	/	/
16	731617106058	SANTHIYA Y	/	/	/	/	/	/	/	/	/	/	/	/
17	731617106059	SANTHOSH K	/	/	/	/	/	/	/	/	/	/	/	/
18	731617106060	SHALINI V	/	/	/	/	/	/	a	a	/	/	/	/
19	731617106061	SHANMATHI M M	/	/	/	/	/	/	/	/	/	/	/	/
20	731617106062	SHARUMATHI S	/	/	/	/	/	/	/	/	/	/	/	/
21	731617106063	SINDUJA K	/	/	/	/	/	/	/	/	/	/	/	/
22	731617106064	SIVASANKARAN K	a	/	/	/	/	/	/	/	/	/	/	/
23	731617106065	SOFIA A	/	/	/	/	a	a	/	/	/	/	/	/
24	731617106066	SOWMIYA G V	/	/	/	/	/	/	/	/	/	/	/	/
25	731617106067	SREEMATHI G	/	/	/	/	/	/	/	/	/	/	/	/
26	731617106068	SRIDHARAN M	/	/	/	/	/	/	/	/	/	/	/	/
27	731617106069	SRINIVASAN A	/	/	/	/	/	/	/	/	/	/	/	/
28	731617106070	SRINIVASAN S R	/	/	/	/	/	/	a	/	/	/	/	/
29	731617106071	SRI RANJANI S	/	/	/	/	/	/	/	/	/	/	/	/
30	731617106073	SUBASH K	/	/	/	/	/	/	/	/	/	/	/	/
31	731617106074	SUDHA G	/	/	/	/	/	/	/	/	/	/	/	/
32	731617106075	SUKHESAN C	/	/	/	/	a	a	/	/	/	/	/	/
33	731617106076	SURESH K	/	/	/	/	/	/	/	/	/	/	/	/
34	731617106077	SURYAPRIYA K	/	/	/	/	/	/	/	/	/	/	/	/
35	731617106078	SUSHMITHA A	/	/	/	/	/	/	/	/	/	/	/	/

PRINCIPAL,
K. S. R. INSTITUTE FOR
ENGINEERING AND TECHNOLOGY,
K. S. R. KALVI NAGAR,
TIRUCHENGODE-637 215
NAMAKKAL Dt, TAMIL NADU.

Training Date			11.06.18		12.06.18		18.06.18		19.06.18		28.06.18		29.06.18	
S. No		Name	FN	AN	FN	AN	FN	AN	FN	AN	FN	AN	FN	AN
36	731617106079	SWEETLIN JOSHVA A	/	/	/	/	/	/	/	/	/	/	/	/
37	731617106080	SWETHA G P	/	/	/	/	/	/	/	/	/	/	/	/
38	731617106081	TAMILZHAGAN G	/	/	a	#	/	/	/	/	/	/	/	/
39	731617106082	TEJASWINI S	/	/	/	/	/	/	/	/	/	/	/	/
40	731617106083	THARUN KUMAR K	/	/	/	/	/	/	/	/	/	/	/	/
41	731617106084	THIYAGU M	/	/	/	/	/	/	/	/	/	/	/	/
42	731617106085	UDAYAKUMAR R	/	/	/	/	/	/	/	/	/	/	/	/
43	731617106086	YASODHA P	/	/	/	/	/	/	/	/	/	/	/	/
44	731617106087	YUVANSANKAR K	/	/	/	/	/	/	/	/	/	/	/	/
45	731617106088	ZUBAIR M	/	/	a	a	/	/	/	/	/	/	/	/
PRESENT			43	44	44	44	4	039	44	44	44	44	44	44
ABSENT			2	1	1	1	2	3	1	1	1	1	1	1
PERMISSION			-	-	-	-	3	3	+	+	+	+	+	+
OD			-	-	-	-	-	-	+	+	+	+	+	+

PRINCIPAL,
K. S. R. INSTITUTE FOR
ENGINEERING AND TECHNOLOGY,
K. S. R. KALVI NAGAR,
TIRUCHENGODE-637 215,
NAMAKKAL DI, TAMIL NADU.

Training Topics			Programming Skills in C				Communication Skills				Aptitude Skills			
Trainer			Sathiya Priya AP/CSE				Dr.C.Muhuntarajan HoD/Eng				Prof.M.S.Vijayaraj HoD/Maths			
Training Date			13.06.18		14.06.18		18.06.18		20.06.18		03.07.18		04.07.18	
S. No	Reg No	Name	FN	AN	FN	AN	FN	AN	FN	AN	FN	AN	FN	AN
1	731617114058	MOHANARAJ C	a	a	l	l	l	l	l	l	l	l	l	l
2	731617114059	MONISH KANNA M	l	l	l	l	l	l	l	l	l	l	l	l
3	731617114060	MUNEESWARAN D	l	l	l	l	l	l	a	a	a	a	l	l
4	731617114061	NANDHAKUMAR G	l	l	l	l	l	l	l	l	l	l	l	l
5	731617114062	NARESH M	l	l	l	l	l	l	l	l	l	l	a	a
6	731617114063	NAVEEN M	l	l	a	a	l	l	l	l	l	l	l	l
7	731617114064	NAVEEN V	l	l	l	l	l	l	l	l	l	l	l	l
8	731617114065	NIKHIL S	l	l	l	l	a	a	l	l	l	l	l	l
9	731617114066	NITHISH M	a	a	l	l	l	l	l	l	l	l	l	l
10	731617114067	PAVITHRAN G	l	l	l	l	l	l	a	a	a	a	l	l
11	731617114069	PRADEEP N	l	l	a	a	l	l	l	l	l	l	a	a
12	731617114070	PRADHAP R	l	l	l	l	l	l	l	l	l	l	l	l
13	731617114071	PRAGATHEESWAR E	l	l	l	l	l	l	l	l	l	l	l	l
14	731617114072	PRASATH R	l	l	l	l	l	l	l	l	l	l	l	l
15	731617114073	PRATHIYUMANAN M	l	l	l	l	l	l	l	l	l	l	l	l
16	731617114074	PRAVEEN H	l	l	l	l	a	a	l	l	l	l	l	l
17	731617114075	PRAVEENKUMAR V	a	a	l	l	l	l	l	l	l	l	l	l
18	731617114076	PRAVEEN KUMAR S	l	l	l	l	l	l	a	a	a	a	l	l
19	731617114077	PREMRAJ S	l	l	l	l	l	l	l	l	l	l	l	l
20	731617114078	RAHUL V	l	l	l	l	l	l	l	l	l	l	l	l
21	731617114079	RAMKUMAR B	l	l	l	l	l	l	l	l	l	l	l	l
22	731617114080	RANJITHKUMAR K	l	l	l	l	l	l	l	l	l	l	l	l
23	731617114081	SABARINATHAN S	l	l	l	l	l	l	l	l	l	l	a	a
24	731617114082	SAKTHIVEL P	l	l	l	l	a	a	l	l	l	l	l	l
25	731617114083	SANTHOSHKUMAR G	l	l	l	l	l	l	l	l	l	l	l	l
26	731617114084	SARAN KUMAR D	l	l	l	l	l	l	l	l	l	l	l	l
27	731617114085	SARATH KUMAR M	l	l	l	l	l	l	a	a	l	l	l	l
28	731617114086	SARAVANAA M	l	l	l	l	l	l	l	l	l	l	l	l
29	731617114087	SARAVANAN R	l	l	l	l	l	l	l	l	a	a	l	l
30	731617114088	SASIKARAN S	l	l	l	l	l	l	l	l	l	l	a	a
31	731617114089	SATHISHKUMAR S	l	l	l	l	a	a	l	l	l	l	l	l
32	731617114090	SHAJAHAN S	l	l	l	l	l	l	l	l	l	l	l	l
33	731617114091	SRIDHAR C	l	l	l	l	l	l	l	l	l	l	l	l
34	731617114092	SRIDHARAN R	l	l	l	l	l	l	l	l	l	l	l	l

 PRINCIPAL
 K. S. R. INSTITUTE FOR
 ENGINEERING AND TECHNOLOGY,
 " S R. KALVI NAGAR,
 TIRUCHENGODE-637 215,
 TAMIL NADU.

Trainng Date			13.06.18		14.06.18		18.06.18		20.06.18		03.07.18		04.07.18	
S. No	Reg No	Name	FN	AN	FN	AN	FN	AN	FN	AN	FN	AN	FN	AN
35	731617114093	SURENDHAR P	/	/	/	/	/	/	/	/	/	/	/	/
36	731617114094	SURESHKUMAR A	/	/	/	/	/	/	/	/	/	/	/	/
37	731617114095	SURESHMOORTHY P	/	/	/	/	/	/	/	/	/	/	/	/
38	731617114096	SURYAMOORTHI R	/	/	/	/	/	/	/	/	/	/	/	/
39	731617114098	TAMILSELVAN V	/	/	/	/	/	/	/	/	/	/	/	/
40	731617114099	THAMIL SELVAM B	/	/	/	/	/	/	/	/	/	/	/	/
41	731617114100	THIRUPATHI M	/	/	/	/	/	/	/	/	/	/	/	/
42	731617114101	THULASI RAMAN R	/	/	/	/	/	/	/	/	/	/	/	/
43	731617114102	VIGNESH R	/	/	/	/	/	/	/	/	/	/	/	/
44	731617114103	VIGNESHWARAN S	/	/	/	/	/	/	/	/	/	/	/	/
45	731617114104	VIJAYAKUMAR C	/	/	/	/	/	/	/	/	/	/	/	/
46	731617114105	VINITH D	/	/	/	/	/	/	/	/	/	/	/	/
47	731617114106	VINOTH KUMAR T	/	/	/	/	/	/	/	/	/	/	/	/
48	731617114107	YASWANTHKARTHIKS	/	/	/	/	/	/	/	/	/	/	/	/
49	731617114108	YOGESH N	/	/	/	/	/	/	/	/	/	/	/	/
50	731617114301	R. Abhishek	/	/	/	/	/	/	/	/	/	/	/	/
51	731617114302	Dineshwaran .	/	/	/	/	/	/	/	/	/	/	/	/
52	731617114303	M.Hariprasad	/	/	/	/	/	/	/	/	/	/	/	/
53	731617114304	E.Kannan	/	/	/	/	/	/	/	/	/	/	/	/
54	731617114305	V.Manikandan	/	/	/	/	/	/	/	/	/	/	/	/
55	731617114306	Nantha kumar	/	/	/	/	/	/	/	/	/	/	/	/
PRESENT			42	42	47	47	42	42	46	46	48	48	46	46
ABSENT			4	4	3	3	6	6	6	6	5	5	9	9
PERMISSION			4	4	1	1	3	3	3	3	2	2	-	-
OD			-	-	-	-	-	-	-	-	-	-	-	-

PRINCIPAL,
K. S. R. INSTITUTE FOR
ENGINEERING AND TECHNOLOGY
K. S. R. KALM NAGAR,
TIRUCHENGODE-637 215.
NAMAKKAL DISTRICT, TAMIL NADU.

Internal Basic Communication, Aptitude & Programming In C Training Attendance

BATCH: 2017 - 2021

ACADEMIC YEAR: 2018 - 2019 (ODD)

DATE: 11.06.2018

Fore Noon session

S.NO	BRANCH	STRENGTH	PRESENT	ABSENT	Leave
1	CSE	57	39	17	1
2	ECE - A	40	32	8	0
3	EEE	52	43	9	0
4	IT	54	43	11	0
Total		203	157	45	1

After Noon Session

S.NO	BRANCH	STRENGTH	PRESENT	ABSENT	PERMISSION
1	CSE	57	37	20	0
2	ECE - A	40	32	8	0
3	EEE	52	44	8	0
4	IT	54	43	11	0
Total		203	156	47	0

F. K. K. K.
T & P OFFICER
11/6/18

[Signature]
T & P CO ORDINATOR

[Signature]
PRINCIPAL

[Signature]
PRINCIPAL,
K. S. R. INSTITUTE FOR
ENGINEERING AND TECHNOLOGY,
K. S. R. KALVI NAGAR,
TIRUCHENGODE-637 215,
NAMAKKAL DI, TAMIL NADU.

Internal Basic Communication, Aptitude & Programming In C Training Attendance

BATCH: 2017 - 2021

ACADEMIC YEAR: 2018 - 2019 (ODD)

DATE: 12.06.2018

Fore Noon session

S.NO	BRANCH	STRENGTH	PRESENT	ABSENT	Leave
1	CSE	55	40	15	0
2	ECE - A	37	33	4	0
3	EEE	52	40	12	0
4	IT	54	46	8	0
Total		198	159	39	0

After Noon Session

S.NO	BRANCH	STRENGTH	PRESENT	ABSENT	PERMISSION
1	CSE	55	40	15	0
2	ECE - A	37	33	4	0
3	EEE	52	42	10	0
4	IT	54	46	8	0
Total		198	161	37	0

K. K. Kalvi
T & P OFFICER
12/06/18

T&P CO ORDINATOR
12/06/18

PRINCIPAL
12/06/18

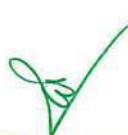
PRINCIPAL
K. S. R. INSTITUTE FOR
ENGINEERING AND TECHNOLOGY,
K. S. R. KALVI NAGAR,
TIRUCHENGODE-637215
NAMAKKAL DISTRICT, TAMIL NADU.

Internal Basic Communication, Aptitude & Programming In C Training Attendance

BATCH: 2017 - 2021

ACADEMIC YEAR: 2018 - 2019 (ODD)

DATE: 13.06.2018

Fore Noon session

S.NO	BRANCH	STRENGTH	PRESENT	ABSENT	Leave
1	IT	54	46	8	0
2	MECH A	55	54	1	0
3	MECH B	50	42	4	4
Total		159	142	13	4

After Noon Session

S.NO	BRANCH	STRENGTH	PRESENT	ABSENT	PERMISSION
1	IT	54	46	8	0
2	MECH A	55	54	1	0
3	MECH B	50	42	4	4
Total		159	142	13	4

V. Kaluth
T & P OFFICER

[Signature]
T&P CO ORDINATOR

PRINCIPAL

[Signature]
PRINCIPAL,
K. S. R. INSTITUTE FOR
ENGINEERING AND TECHNOLOGY,
K. S. R. KALVI NAGAR,
TIRUCHENGODE-637 215,
NAMAKKAL DI, TAMIL NADU.

Internal Basic Communication, Aptitude & Programming In C Training Attendance

BATCH: 2017 - 2021

ACADEMIC YEAR: 2018 - 2019 (ODD)

DATE: 14.06.2018

Fore Noon session

S.NO	BRANCH	STRENGTH	PRESENT	ABSENT	Leave
1	IT	54	39	15	0
2	MECH A	55	52	3	0
3	MECH B	51	47	3	1
Total		160	138	21	1

After Noon Session

S.NO	BRANCH	STRENGTH	PRESENT	ABSENT	PERMISSION
1	IT	54	39	15	0
2	MECH A	55	52	3	0
3	MECH B	51	47	3	1
Total		160	138	21	1

V. K. Kalvi
T&P OFFICER'S
14/6/18

[Signature]
T&P CO ORDINATOR
14/6/18

[Signature]
PRINCIPAL

PRINCIPAL,
K. S. R. INSTITUTE FOR
ENGINEERING AND TECHNOLOGY,
K. S. R. KALVI NAGAR,
TIRUCHENGODE-637 215,
NAMAKKAL DI, TAMIL NADU.

Internal Basic Communication, Aptitude & Programming In C Training Attendance

BATCH: 2017 - 2021

ACADEMIC YEAR: 2018 - 2019(ODD)

DATE: 18.06.2018

Fore Noon session

S.NO	BRANCH	STRENGTH	PRESENT	ABSENT	Leave
1	ECE A	37	36	1	0
2	ECE B	45	42	3	0
3	MECH A	55	53/40	0	2
4	MECH B	51	42	6	3
Total		188	173	10	5

After Noon Session

S.NO	BRANCH	STRENGTH	PRESENT	ABSENT	PERMISSION
1	ECE A	37	36	1	0
2	ECE B	45	42	3	0
3	MECH A	55	53/37	0	2
4	MECH B	51	42	6	3
Total		188	173	10	5

f. Kalvi TB
T & P OFFICER
18/6/18

T&P CO ORDINATOR
18/6/18

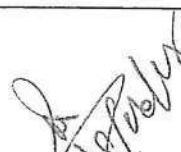
PRINCIPAL

PRINCIPAL,
K. S. R. INSTITUTE FOR
ENGINEERING AND TECHNOLOGY
K. S. R. KALVI NAGAR,
TIRUCHENGODE-637 215,
NAMAKKAL Dt, TAMIL NADU.

TRAINING & PLACEMENT CELL



Internal Basic Communication, Aptitude & Programming In C Training Attendance

BATCH: 2017 - 2021

ACADEMIC YEAR: 2018 - 2019 (ODD)

DATE: 19.06.2018

Fore Noon session

S.NO	BRANCH.	STRENGTH	PRESENT	ABSENT	Leave
1	ECE A	37	35	2	0
2	ECE B	45	40	2	3
3	MECH A	55	55	0	0
Total		137	130	4	3

After Noon Session

S.NO	BRANCH	STRENGTH	PRESENT	ABSENT	Leave
1	ECE A	37	35	2	0
2	ECE B	45	39	3	3
3	MECH A	55	55	0	0
Total		137	129	5	3

Y. Kalith
T & P OFFICER
19/6/18

A. S. S.
T&P CO ORDINATOR
19/6/18

A. S. S.
PRINCIPAL
19/6/18

(Green Checkmark)
PRINCIPAL,
K. S. R. INSTITUTE FOR
ENGINEERING AND TECHNOLOGY,
K. S. R. KALVI NAGAR,
TIRUCHENGODE-637 215,
NAMAKKAL DI, TAMIL NADU.

Internal Basic Communication, Aptitude & Programming In C Training Attendance

BATCH: 2017 - 2021

ACADEMIC YEAR: 2018 - 2019 (ODD)

DATE: 20.06.2018

Fore Noon session

S.NO	BRANCH	STRENGTH	PRESENT	ABSENT	Leave
1	MECH B	55	46	6	3
Total		55	46	6	3

After Noon Session

S.NO	BRANCH	STRENGTH	PRESENT	ABSENT	Leave
1	MECH B	55	46	6	3
Total		55	46	6	3

[Signature]
T & P OFFICER
20.06.18

[Signature]
T&P CO ORDINATOR

[Signature]
PRINCIPAL

[Signature]
PRINCIPAL,
K. S. R. INSTITUTE FOR
ENGINEERING AND TECHNOLOGY,
K. S. R. KALVI NAGAR,
TIRUCHENGODE-637 215,
NAMAKKAL DI, TAMIL NADU.

Internal Basic Communication, Aptitude & Programming In C Training Attendance

BATCH: 2017 - 2021

ACADEMIC YEAR: 2018 - 2019 (ODD)

DATE: 21.06.2018

Fore Noon session

S.NO	BRANCH	STRENGTH	PRESENT	ABSENT	Leave
1	CSE	55	46	9	0
2	EEE	51	49	1	1
Total		51	49	1	1

After Noon Session

S.NO	BRANCH	STRENGTH	PRESENT	ABSENT	Leave
1	CSE	55	46	9	0
2	EEE	51	49	1	1
Total		51	49	1	1

V. Kalvi
T & P OFFICER
21/6/18

[Signature]
21/6/18
T&P CO ORDINATOR

[Signature]
21/6/18
PRINCIPAL

[Green Checkmark]
PRINCIPAL
K. S. R. INSTITUTE FOR
ENGINEERING AND TECHNOLOGY,
K. S. R. KALVI NAGAR,
TIRUCHENGODE-637 215,
NAMAKKAL Dt, TAMIL NADU.

Internal Basic Communication, Aptitude & Programming In C Training Attendance

BATCH: 2017 - 2021

ACADEMIC YEAR: 2018 - 2019(ODD)

DATE: 22.06.2018

Fore Noon session

S.NO	BRANCH	STRENGTH	PRESENT	ABSENT	Leave
1	CSE	55	46	7	2
2	EEE	51	46	2	3
Total		51	46	2	3

T & P OFFICER
22/6/18

T & P CO ORDINATOR
22/06/18

PRINCIPAL
22/6/18

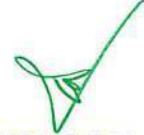
PRINCIPAL,
K. S. R. INSTITUTE FOR
ENGINEERING AND TECHNOLOGY,
K. S. R. KALVI NAGAR,
TIRUCHENGODE-637 215,
NAMAKKAL Dt, TAMIL NADU.

K S R INSTITUTE FOR ENGINEERING AND TECHNOLOGY, TIRUCHENGODE - 637215

TRAINING & PLACEMENT CELL



Internal Basic Communication, Aptitude & Programming In C Training Attendance

BATCH: 2017 - 2021

ACADEMIC YEAR: 2018 - 2019 (ODD)

DATE: 25.06.2018

Fore Noon session

S.NO	BRANCH	STRENGTH	PRESENT	ABSENT	Leave
1	IT	54	46	8	0
2	EEE	51	48	3	0
Total		105	94	11	0

After Noon session

S.NO	BRANCH	STRENGTH	PRESENT	ABSENT	Leave
1	IT	54	47	7	0
2	EEE	51	48	3	0
Total		105	95	10	0

T & P OFFICER

T & P CO ORDINATOR

PRINCIPAL

PRINCIPAL,
K. S. R. INSTITUTE FOR
ENGINEERING AND TECHNOLOGY,
K. S. R. KALVI NAGAR,
TIRUCHENGODE-637 215,
NAMAKKAL DI, TAMIL NADU.

Internal Basic Communication, Aptitude & Programming In C Training Attendance

BATCH: 2017 - 2021

ACADEMIC YEAR: 2018 - 2019 (ODD)

DATE: 26.06.2018

Fore Noon session

S.NO	BRANCH	STRENGTH	PRESENT	ABSENT	Leave
1	IT	54	49	4	1
2	EEE	51	46	5	0
Total		105	95	9	1

After Noon session

S.NO	BRANCH	STRENGTH	PRESENT	ABSENT	Leave
1	IT	54	49	4	1
2	EEE	51	46	5	0
Total		105	95	9	1

T & P OFFICER
26/6/18

T&P CO ORDINATOR
26/6/18

PRINCIPAL
26/6/18

PRINCIPAL,
K. S. R. INSTITUTE FOR
ENGINEERING AND TECHNOLOGY,
K. S. R. KALVI NAGAR,
TIRUCHENGODE-637 215,
NAMAKKAL DI, TAMIL NADU.

Internal Basic Communication, Aptitude & Programming In C Training Attendance

BATCH: 2017 - 2021

ACADEMIC YEAR: 2018 - 2019 (ODD)

DATE: 28.06.2018

Fore Noon session

S.NO	BRANCH	STRENGTH	PRESENT	ABSENT	Leave
1	ECE A	37	37	0	0
2	ECE B	45	44	1	0
Total		82	81	1	0

After Noon session

S.NO	BRANCH	STRENGTH	PRESENT	ABSENT	Leave
1	ECE A	37	37	0	0
2	ECE B	45	44	1	0
Total		82	81	1	0

[Handwritten Signature]
T & P OFFICER
28/6/18

[Handwritten Signature]
28/6/18
T&P CO ORDINATOR

[Handwritten Signature]
PRINCIPAL

[Green Stamp]
PRINCIPAL,
K. S. R. INSTITUTE FOR
ENGINEERING AND TECHNOLOGY,
K. S. R. KALVI NAGAR,
TIRUCHENGODE-637 215,
NAMAKKAL DE, TAMIL NADU.



Internal Basic Communication, Aptitude & Programming In C Training Attendance

BATCH: 2017 - 2021

ACADEMIC YEAR: 2018 - 2019 (ODD)

DATE: 29.06.2018

Fore Noon session

S.NO	BRANCH	STRENGTH	PRESENT	ABSENT	Leave
1	ECE A	37	36	1	0
2	ECE B	45	41	2	2
Total		82	77	3	2

After Noon session

S.NO	BRANCH	STRENGTH	PRESENT	ABSENT	Leave
1	ECE A	37	36	1	0
2	ECE B	45	41	2	2
Total		82	77	3	2

[Signature]
T & P OFFICER
29/6/18

[Signature]
T&P CO ORDINATOR
29/6/18

[Signature]
PRINCIPAL
29/6/18

[Signature]
PRINCIPAL,
K. S. R. INSTITUTE FOR
ENGINEERING AND TECHNOLOGY,
K. S. R. KALVI NAGAR,
TIRUCHENGODE-637 215,
NAMAKKAL Dt, TAMIL NADU.

Internal Basic Communication, Aptitude & Programming In C Training Attendance

BATCH: 2017 - 2021

ACADEMIC YEAR: 2018 - 2019 (ODD)

DATE: 03.07.18

Fore Noon session

S.NO	BRANCH	STRENGTH	PRESENT	ABSENT	Leave
1	MECH A	55	54	1	0
2	MECH B	55	48	5	2
Total		110	102	6	2

After Noon session

S.NO	BRANCH	STRENGTH	PRESENT	ABSENT	Leave
1	MECH A	55	54	1	0
2	MECH B	55	48	5	2
Total		110	102	6	2

[Signature]
T & P OFFICER
3/7/18

[Signature]
T&P CO ORDINATOR
3/7/18

[Signature]
PRINCIPAL

[Signature]
PRINCIPAL.
K. S. R. INSTITUTE FOR
ENGINEERING AND TECHNOLOGY,
K. S. R. KALVI NAGAR,
TIRUCHENGODE-637 215,
NAMAKKAL DI. TAMIL NADU.

K S R INSTITUTE FOR ENGINEERING AND TECHNOLOGY, TIRUCHENGODE - 637215

TRAINING & PLACEMENT CELL



Internal Basic Communication, Aptitude & Programming In C Training Attendance

BATCH: 2017 - 2021

ACADEMIC YEAR: 2018 - 2019 (ODD)

DATE: 04.07.2018

Fore Noon session

S.NO	BRANCH	STRENGTH	PRESENT	ABSENT	Leave
1	MECH A	55	52	0	3
2	MECH B	55	46	9	0
Total		110	98	9	3

After Noon session

S.NO	BRANCH	STRENGTH	PRESENT	ABSENT	Leave
1	MECH A	55	52	0	3
2	MECH B	55	46	9	0
Total		110	98	9	3

V. Kalish
T & P OFFICER

[Signature]
T&P CO ORDINATOR

[Signature]
PRINCIPAL

[Signature]
PRINCIPAL,
K. S. R. INSTITUTE FOR
ENGINEERING AND TECHNOLOGY,
K. S. R. KALVI NAGAR,
TIRUCHENGODE-637 215,
NAMAKKAL DL, TAMIL NADU.

Internal Basic Communication, Aptitude & Programming In C Training Attendance

BATCH: 2017 - 2021

ACADEMIC YEAR: 2018 - 2019 (ODD)

DATE: 01.08.2018

Fore Noon session

S.NO	BRANCH	STRENGTH	PRESENT	ABSENT	Leave
1	ECE B	45	43	2	0
Total		45	43	2	0

After Noon session

S.NO	BRANCH	STRENGTH	PRESENT	ABSENT	Leave
1	ECE B	45	43	1	0
Total		45	43	1	0

BATCH: 2017 - 2021

ACADEMIC YEAR: 2018 - 2019 (ODD)

DATE: 02.08.2018

Fore Noon session

S.NO	BRANCH	STRENGTH	PRESENT	ABSENT	Leave
1	ECE B	45	43	1	0
Total		45	43	1	0

After Noon session

S.NO	BRANCH	STRENGTH	PRESENT	ABSENT	Leave
1	ECE B	45	43	1	0
Total		45	43	1	0

T & P OFFICER

T&P CO ORDINATOR

PRINCIPAL

PRINCIPAL.
K. S. R. INSTITUTE FOR
ENGINEERING AND TECHNOLOGY,
K. S. R. KALVI NAGAR,
TIRUCHENGODE-637 215,
NAMAKKAL Dt, TAMIL NADU.

Internal Basic Communication, Aptitude & Programming In C Training Attendance

BATCH: 2017 - 2021

ACADEMIC YEAR: 2018 - 2019 (ODD)

DATE: 09.08.2018

Fore Noon session

S.NO	BRANCH	STRENGTH	PRESENT	ABSENT	Leave
1	CSE	55	50	5	0
Total		55	50	5	0

After Noon session

S.NO	BRANCH	STRENGTH	PRESENT	ABSENT	Leave
1	CSE	55	50	5	0
Total		55	50	5	0

BATCH: 2017 - 2021

ACADEMIC YEAR: 2018 - 2019 (ODD)

DATE: 10.08.2018

Fore Noon session

S.NO	BRANCH	STRENGTH	PRESENT	ABSENT	Leave
1	CSE	55	50	5	0
Total		55	50	5	0

After Noon session

S.NO	BRANCH	STRENGTH	PRESENT	ABSENT	Leave
1	CSE	55	50	5	0
Total		55	50	5	0

T & P OFFICER
10/8/18

T&P CO ORDINATOR

PRINCIPAL

PRINCIPAL,
K. S. R. INSTITUTE FOR
ENGINEERING AND TECHNOLOGY,
K S R KALVI NAGAR,
TIRUCHENGODE-637 215,
NARAIKAL DI, TAMIL NADU.



TRAINING PROGRAMME FEEDBACK FORM

Name of the Student: Hari Prasad Branch: B.TECH/IT

Year / Sem: II / 3

4. Name of the Training: Programming Skills in C

5. Name of the Trainer: Nanda Mr. Nandagopal

6. Students rating of Trainers :

S. No.	Date	Subject	Rating (√)			
			Excellent	Very good	Good	Average
1	11.6.2018	Programming in C			✓	

4. Two positive points about the programme:

It is very useful for all.

It face a complicated questions

5. Suggestions for improvement:

It is useful to improve my programming skills.

Date: 11.6.2018

Signature

K. Hari Prasad



TRAINING PROGRAMME FEEDBACK FORM

Name of the Student: SHIVANI Branch: IT

Year / Sem: II / III

1. Name of the Training: Basic Programming in C

2. Name of the Trainer: Ms. Nandha Gopal

3. Students rating of Trainers :

S. No.	Date	Subject	Rating (√)			
			Excellent	Very good	Good	Average
1	11/06/18	Basic in C			✓	

4. Two positive points about the programme:

We regain the knowledge & basis in

C Programming

5. Suggestions for improvement:

Teach with example program based on

concepts

N. Shif.

Date: 11/06/18

Signature

**K S R INSTITUTE FOR ENGINEERING AND TECHNOLOGY
TIRUCHENGODE - 637 215**

TRAINING PROGRAMME FEEDBACK FORM



Name of the Student: S. HEMALATHA

Branch: B.E / EEE

Year / Sem: II / III

1. Name of the Training: Programming skills in C

2. Name of the Trainer: D. Balakrishnan

3. Students rating of Trainers :

- 1) Greatest of 3 no.s
- 2) Prime or not
- 3) Factorial
- 4) Table using do while

S. No.	Date	Subject	Rating (√)			
			Excellent	Very good	Good	Average
1	11-06-18	<u>C-Program (intro)</u> <u>data types, looping,</u> <u>process, decision</u> <u>making</u>	✓			

4. Two positive points about the programme: Developing in computer language
or problem solving technique

5. Suggestions for improvement: Give more problems to solve

Date: 11-06-18

[Signature]
Signature

**K S R INSTITUTE FOR ENGINEERING AND TECHNOLOGY
TIRUCHENGODE - 637 215**

TRAINING PROGRAMME FEEDBACK FORM



Name of the Student: T. EZHILAN

Branch: B.E. EEE

Year / Sem: II / III

4. Name of the Training: programming skills in C

5. Name of the Trainer: D. Bala Krishnan

6. Students rating of Trainers :

S. No.	Date	Subject	Rating (√)			
			Excellent	Very good	Good	Average
1	11.6.2018	<u>C-programming</u>	✓			

4. Two positive points about the programme: Very kind and easy
handling us in subject wise

5. Suggestions for improvement: Explicit problems
how to solve

Date: 11.6.2018

PRINCIPAL
K. S. R. INSTITUTE FOR
ENGINEERING AND TECHNOLOGY,
K. S. R. KAVELI NAGAR,
TIRUCHENGODE-637 215,
NAMAKKAL Dt, TAMIL NADU.

[Signature]
Signature



TRAINING PROGRAMME FEEDBACK FORM

Name of the Student: P. N. KOTEESHWARAN Branch: CSE

Year / Sem: 11 / III

1. Name of the Training: Programming skills in C.

2. Name of the Trainer: SHRMIKA N. S

3. Students rating of Trainers :

S. No.	Date	Subject	Rating (√)			
			Excellent	Very good	Good	Average
1	11.06.18	Basic Programming in 'C'	✓			

4. Two positive points about the programme:

Basic things of the programming was explained clearly.

5. Suggestions for improvement:

Date: 11/6/18

P. N. Koteeshwaran
Signature



TRAINING PROGRAMME FEEDBACK FORM

Name of the Student: P. Sneha Branch: CSE

Year / Sem: 11 / III

4. Name of the Training: Programming skills in C.

5. Name of the Trainer: SHRMIKA N. S

6. Students rating of Trainers :

S. No.	Date	Subject	Rating (√)			
			Excellent	Very good	Good	Average
1	11.06.2018	Basic Programming in C	✓			

4. Two positive points about the programme:

All codings are explained step by step by understanding them clearly.

5. Suggestions for improvement:

Give some clear program to solve.

Date: 11/6/18

PRINCIPAL,
K. S. R. INSTITUTE FOR
ENGINEERING AND TECHNOLOGY,
K. S. R. KALVI PAGER,
TIRUCHENGODE-637 215,
NAMAKKAL Dt, TAMIL NADU.

P. Sneha
Signature



Name of the Student: P. DINNESH

Branch: BE/ECE

Year / Sem: II / III

1. Name of the Training: APTITUDE SKILLS

2. Name of the Trainer: Mr. VISAYARAJ

3. Students rating of Trainers: 9/10

S. No.	Date	Subject	Rating (✓)			
			Excellent	Very good	Good	Average
1	11/06/18	Maths	✓			

4. Two positive points about the programme:
 * Our aptitude skill will be improved and we can solve the problems easily.

5. Suggestions for improvement:
 * Easy for us to place and clear the aptitude level.
 More problems can be practised

Date: 11/06/2018

Signature P. Dinnesh



Name of the Student: S. Keerthana

Branch: BE/ECE

Year / Sem: II / 3

4. Name of the Training: Aptitude

5. Name of the Trainer: Mr. Vijayaraj

6. Students rating of Trainers: 8.56

S. No.	Date	Subject	Rating (✓)			
			Excellent	Very good	Good	Average
1	11/6/18	Aptitude.		✓		

4. Two positive points about the programme:
 * It is easy to solve as it involves basic mathematics.

5. Suggestions for improvement:
 * It is the basic requirement for all entrance exams.
 [Nothing] for K. S. R. INSTITUTE FOR ENGINEERING AND TECHNOLOGY, K. S. R. KALVI NAGAR, TIRUCHENGODE-637 215, NAMAKKAL DI, TAMIL NADU.

Date: 11/6/18

Signature [Signature]



TRAINING PROGRAMME FEEDBACK FORM

Name of the Student: THAMIZHSELVAN R Branch: EEE

Year / Sem: II / III

4. Name of the Training: C programming.

5. Name of the Trainer: BALAKRISHNAN

6. Students rating of Trainers :

S. No.	Date	Subject	Rating (√)			
			Excellent	Very good	Good	Average
1	11.6.18, 12-6-18	'C' program Basic		✓		

4. Two positive points about the programme: known about basic 'C' programming.

5. Suggestions for improvement: learn 'C' language

Date: 12.6.18

R. Thamizhselvan
Signature



TRAINING PROGRAMME FEEDBACK FORM

Name of the Student: Muthulakshmi S Branch: ECB-A

Year / Sem: 2nd / 3rd

1. Name of the Training: APTITUDE

2. Name of the Trainer: Vijay Raj

3. Students rating of Trainers : 9

S. No.	Date	Subject	Rating (√)			
			Excellent	Very good	Good	Average
1	12.6.18	APTITUDE				

4. Two positive points about the programme: He teach very clearly

5. Suggestions for improvement: -

Date: 12.6.18

Vijay Raj
Signature

[Signature]
PRINCIPAL
K. S. R. INSTITUTE FOR
ENGINEERING AND TECHNOLOGY,
K. S. R. KALVI NAGAR,
TIRUCHENGODE-637 215,
NAMAKKAL DISTRICT, TAMIL NADU.

TRAINING PROGRAMME FEEDBACK FORM

Name of the Student: R. Hari Hara Sudhan

Branch: EEE-A

Year / Sem: 2nd / 3rd

4. Name of the Training: VIJAYRAJ (APTITUDE)

5. Name of the Trainer: VIJAYRAJ

6. Students rating of Trainers: 9.5

S. No.	Date	Subject	Rating (✓)			
			Excellent	Very good	Good	Average
1	12/6/18	APTITUDE	✓			

4. Two positive points about the programme:

Good planning
Good teaching

5. Suggestions for improvement: -

Signature

Date: 12/6/18

TRAINING PROGRAMME FEEDBACK FORM

Name of the Student: T. Mohan

Branch: EEE

Year / Sem: II / III

1. Name of the Training: c programming basics

2. Name of the Trainer:

3. Students rating of Trainers: Balakrishnan

S. No.	Date	Subject	Rating (✓)			
			Excellent	Very good	Good	Average
1	11-06-18	c-Programs			✓	

4. Two positive points about the programme:

1] learnt about c basics
2] learnt basic problem solving technique

5. Suggestions for improvement:

Teach some more basics in c

PRINCIPAL
K. S. R. INSTITUTE FOR
ENGINEERING AND TECHNOLOGY,
K. S. R. KALVI NAGAR,
TIRUCHENGODE-637 215,
NAMAKKAL DISTRICT, TAMIL NADU.

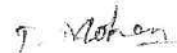
Signature



Name of the Student: N. MOHANAPREYA

Branch: B.E - CSE

Year / Sem: i / iii

1. Name of the Training: C Programming

2. Name of the Trainer: N. Sharmila

3. Students rating of Trainers :

S. No.	Date	Subject	Rating (√)			
			Excellent	Very good	Good	Average
1	12.6.18	C Programming	✓			

4. Two positive points about the programme: Can able to learn the C Programming in detail.

Can able to review and getting thorough in the Language

5. Suggestions for improvement:

Extend the classes for one more day.

Date: 12.6.18

N. Mohanap
Signature



Name of the Student: ARVINKUMAR N

Branch: B.E. CSE

Year / Sem: 02 II/03

4. Name of the Training: C programming

5. Name of the Trainer: N. Sharmila

6. Students rating of Trainers :

S. No.	Date	Subject	Rating (√)			
			Excellent	Very good	Good	Average
1	12.6.18	C programming			✓	

4. Two positive points about the programme:

To get clear idea about the principle of the program

5. Suggestions for improvement:

Want next level programs

teaching base

Want next level in programs.

Date: 12.6.18

PRINCIPAL
K. S. R. INSTITUTE FOR
ENGINEERING AND TECHNOLOGY,
K. S. R. KALVI NAGAR,
TIRUCHENGODE - 637 215,
NAMAKKAL DI, TAMIL NADU.

[Signature]
Signature



Name of the Student: R. Senthil Kumar

Branch: B. TECH-IT

Year / Sem: I yr / III Sem

1. Name of the Training: Programming in C

functions
structure

2. Name of the Trainer: Nandagopal

3. Students rating of Trainers :

S. No.	Date	Subject	Rating (√)			
			Excellent	Very good	Good	Average
1	12.06.18	Programming in C		✓		

4. Two positive points about the programme: * we have done most of the programmes

* level of teaching by staff was good

5. Suggestions for improvement: * apart from basic, many new and advanced concepts can be taught with practice

Date: 12.06.18

R. Senthil Kumar
Signature



Name of the Student: M. GOBIKA

Branch: IT

Year / Sem: II / III

4. Name of the Training: Programming in C

5. Name of the Trainer: Nandagopal

6. Students rating of Trainers :

S. No.	Date	Subject	Rating (√)			
			Excellent	Very good	Good	Average
1	12.06.18	PROGRAMMING IN C		✓		

4. Two positive points about the programme: In this class we got the basic ideas about the programming language. Recalling of the basics made us to get clear ideas which programming skill beginning to our

5. Suggestions for improvement:

Exercises to get practised.

Date: 12.06.18

M. Gobika
Signature
PRINCIPAL
K. S. R. INSTITUTE FOR
ENGINEERING AND TECHNOLOGY,
K. S. R. KALVI NAGAR,
TIRUCHENGODE-637 215
NAMAKKAL DI, TAMIL NADU

**K S R INSTITUTE FOR ENGINEERING AND TECHNOLOGY
TIRUCHENGODE - 637 215**

TRAINING PROGRAMME FEEDBACK FORM



Name of the Student: ARUNI KUMAR S

Branch: B.E - MECH - "A"

Year / Sem: II / 3-Sem

1. Name of the Training :

2. Name of the Trainer :

3. Students rating of Trainers :

S. No.	Date	Subject	Rating (√)			
			Excellent	Very good	Good	Average
1	13.06.2018	CSC	✓			

4. Two positive points about the programme: We have learnt new language
It will help us to improve our programming skills.

5. Suggestions for improvement:

The class can hold more in the lab.

Date:

S. Arun
Signature

**K S R INSTITUTE FOR ENGINEERING AND TECHNOLOGY
TIRUCHENGODE - 637 215**

TRAINING PROGRAMME FEEDBACK FORM



Name of the Student: Ajith Kumar R

Branch: B.E - MECH - "A"

Year / Sem: II / 3-Sem

4. Name of the Training :

5. Name of the Trainer :

6. Students rating of Trainers :

S. No.	Date	Subject	Rating (√)			
			Excellent	Very good	Good	Average
1	13.06.2018	CSC	✓			

4. Two positive points about the programme: We have learnt new language.
It will help us to improve our programming skills.

5. Suggestions for improvement:

The class can hold more in the lab.

Date:

Principal,
K. S. R. INSTITUTE FOR
ENGINEERING AND TECHNOLOGY,
K. S. R. KALVI NAGAR,
TIRUCHENGODE-637 215
NAMAKKAL Dt, TAMIL NADU.
R. Arun
Signature



Name of the Student: C. Mohanaraj

Branch: Mech - R

Year / Sem: II / III

1. Name of the Training: Soft Skills

2. Name of the Trainer: Sathyapriya

3. Students rating of Trainers: 4/5

S. No.	Date	Subject	Rating (√)			
			Excellent	Very good	Good	Average
1	13/6/18	C Programming	✓			

4. Two positive points about the programme:

- i) Good in teaching
- ii) Good communication.

5. Suggestions for improvement:

- i) Applications needed

Date: 13/6/18 - FN

C. Mohanaraj

Signature



Name of the Student: R. Saravanan

Branch: Mech - B

Year / Sem: II / IV

4. Name of the Training: Soft Skills

5. Name of the Trainer: Sathyapriya

6. Students rating of Trainers: 4/5

S. No.	Date	Subject	Rating (√)			
			Excellent	Very good	Good	Average
1	13/6/18	C Programming	✓			

4. Two positive points about the programme:

- i) Good in teaching
- ii) Good communication

5. Suggestions for improvement:

- (i) Applications needed

Date: 13/6/18 - AN

PRINCIPAL.
K. S. R. INSTITUTE FOR
ENGINEERING AND TECHNOLOGY,
K. S. R. KALVI NAGAR,
TIRUCHENGODE-637 215,
NAMAKKAL DI. TAMIL NADU.

R. Saravanan

Signature



Name of the Student: J.P. Jessica Collins

Branch: B. Tech / IT

Year / Sem: II / III

1. Name of the Training: APS Skill

2. Name of the Trainer: Mr. Vijayaraj Siv

3. Students rating of Trainers :

S. No.	Date	Subject	Rating (√)			
			Excellent	Very good	Good	Average
1	13.6.18	maths	✓			

Topic - Time & work, pipes and cisterns, time, speed distance

4. Two positive points about the programme:
 • Was very easy to cope up with
 • ppt was useful.

5. Suggestions for improvement:

Date: 13.6.18

Signature J.P.



Name of the Student: R. Dhanush Adit

Branch: B. tech / IT

Year / Sem: II / III

4. Name of the Training: APS skill

5. Name of the Trainer: Mr. Vijayaraj Siv

6. Students rating of Trainers :

S. No.	Date	Subject	Rating (√)			
			Excellent	Very good	Good	Average
1	13.6.18	Maths	✓			

Topic - Time and work, pipes and cisterns, time, speed distance

4. Two positive points about the programme:
 • PPT presentation was very good

5. Suggestions for improvement:

we want more example every each topics

Date: 13.6.18

PRINCIPAL.
K. S. R. INSTITUTE FOR
ENGINEERING AND TECHNOLOGY,
K. S. R. KALVI NAGAR,
TIRUCHENGODE-637 215,
NAMAKKAL Dt, TAMIL NADU.

Signature R. Dhanush

**K S R INSTITUTE FOR ENGINEERING AND TECHNOLOGY
TIRUCHENGODE - 637 215**

TRAINING PROGRAMME FEEDBACK FORM



Name of the Student: THANESHWARAN Y.G Branch: IT / IInd Year

Year / Sem: 2nd Year / 3rd Sem

1. Name of the Training: Aptitude Skill training

2. Name of the Trainer: Mr. S. Vijayaraj

3. Students rating of Trainers :

S. No.	Date	Subject	Rating (√)			
			Excellent	Very good	Good	Average
1	14.06.18	Aptitude		✓		

4. Two positive points about the programme:

we learn all the 6 topics

5. Suggestions for improvement:

NO

Date: 14.06.2018

Thanesw Y.G
Signature

**K S R INSTITUTE FOR ENGINEERING AND TECHNOLOGY
TIRUCHENGODE - 637 215**

TRAINING PROGRAMME FEEDBACK FORM



Name of the Student: Dracemathi Indira Branch: IT

Year / Sem: 2 / 3rd sem

4. Name of the Training: Aptitude

5. Name of the Trainer: Mr. S. Vijayaraj

6. Students rating of Trainers :

S. No.	Date	Subject	Rating (√)			
			Excellent	Very good	Good	Average
1	14/06/2018	Maths	✓			

4. Two positive points about the programme:

After explaining work out of sums is useful, and concepts

5. Suggestions for improvement:

are easy understood by solving some problems

Date: 14-06-2018

Dracemathi Indira
Signature
K. S. R. INSTITUTE FOR ENGINEERING AND TECHNOLOGY,
K. S. R. KALVI NAGAR,
TIRUCHENGODE-637 215
NAMAKKAL Dt, TAMIL NADU.



Name of the Student: S. BALAJI

Branch: MECH - A

Year / Sem: 2nd - 3rd sem

1. Name of the Training: BASIC PROGRAMMING SKILLS IN C.

2. Name of the Trainer: PRAKASANT

3. Students rating of Trainers :

S. No.	Date	Subject	Rating (✓)			
			Excellent	Very good	Good	Average
1	14.06.18 14.06.18		✓			

4. Two positive points about the programme:

* Very useful & I more learnt about c programming

5. Suggestions for improvement:

We want more class for programming in system.

Date: 14.06.2018.

S. Balaji
Signature



Name of the Student: C.M. DHARSHAN

Branch: MECH - A

Year / Sem: 2nd yr - 3rd sem.

4. Name of the Training: BASIC PROGRAMMING SKILLS IN C.

5. Name of the Trainer: PRAKASANT.

6. Students rating of Trainers :

S. No.	Date	Subject	Rating (✓)			
			Excellent	Very good	Good	Average
1	<u>14-06-18</u>		✓			

4. Two positive points about the programme:

Very useful, I learnt more about c program

5. Suggestions for improvement:

We want more class for programming in laboratory.

Date: 14-06-2018

PRINCIPAL
K. S. R. INSTITUTE FOR
ENGINEERING AND TECHNOLOGY,
K. S. R. KAVI NAGAR,
TIRUCHENGODE-637 215,
NAMAKKAL Dt, TAMIL NADU.

Signature

C.M. Dharsan

**K S R INSTITUTE FOR ENGINEERING AND TECHNOLOGY
TIRUCHENGODE - 637 215**

TRAINING PROGRAMME FEEDBACK FORM



Name of the Student: MUNEESWARAN D

Branch: BE / MECHANICAL

Year / Sem: II / III

1. Name of the Training: Communication Skill

2. Name of the Trainer: Mugurtharaj

3. Students rating of Trainers :

S. No.	Date	Subject	Rating (√)			
			Excellent	Very good	Good	Average
1	18/06/18(FW)	Communication		✓		

4. Two positive points about the programme:

- 1) Given more knowledge about communication English.
- 2) To know how to speak simple English.

5. Suggestions for improvement:

NIL.

Date: 18/06/18.

Signature

[Signature]

**K S R INSTITUTE FOR ENGINEERING AND TECHNOLOGY
TIRUCHENGODE - 637 215**

TRAINING PROGRAMME FEEDBACK FORM



Name of the Student: M. Monish Kanna

Branch: B.E / MECH.

Year / Sem: 2nd / 3rd

4. Name of the Training: placement training

5. Name of the Trainer: C. Mugurtharajan.

6. Students rating of Trainers :

S. No.	Date	Subject	Rating (√)			
			Excellent	Very good	Good	Average
1	18.06.18/AN	Communication English	✓			

4. Two positive points about the programme:

- * developed English knowledge
- * Sir tells very interesting points and facts It is useful for me.

5. Suggestions for improvement:

NIL.

Date: 18.06.2018.

K. S. R. INSTITUTE FOR
ENGINEERING AND TECHNOLOGY,
K. S. R. KALVI NAGAR,
TIRUCHENGODE-637 215,
NAMAKKAL Dt, TAMIL NADU.

Signature

[Signature]

**K S R INSTITUTE FOR ENGINEERING AND TECHNOLOGY
TIRUCHENGODE - 637 215**

TRAINING PROGRAMME FEEDBACK FORM



Name of the Student: N. MOHANAPREYA

Branch: B.E - CSE

Year / Sem: I / III

1. Name of the Training: C Programming

2. Name of the Trainer: N. Sharmila

3. Students rating of Trainers :

S. No.	Date	Subject	Rating (√)			
			Excellent	Very good	Good	Average
1	12.6.18	C Programming	✓			

4. Two positive points about the programme: Can able to learn the C Programming in detail.

Can able to review and getting thorough in the Language

5. Suggestions for improvement:

Extend the classes for one more day.

Date: 12.6.18

N. Mohanapreya
Signature

**K S R INSTITUTE FOR ENGINEERING AND TECHNOLOGY
TIRUCHENGODE - 637 215**

TRAINING PROGRAMME FEEDBACK FORM



Name of the Student: ARUNKUMAR N

Branch: B.E. CSE

Year / Sem: II / 03

4. Name of the Training: C Programming

5. Name of the Trainer: N. Sharmila

6. Students rating of Trainers :

S. No.	Date	Subject	Rating (√)			
			Excellent	Very good	Good	Average
1	12.6.18	C programming			✓	

4. Two positive points about the programme:

To get clear idea about the logic of the program

5. Suggestions for improvement:

Want next level programming teaching

Date: 12.6.18

Want next level in programs.

PRINCIPAL,
K. S. R. INSTITUTE FOR
ENGINEERING AND TECHNOLOGY,
TIRUCHENGODE-637 215,
NAMAKKAL DISTRICT, TAMIL NADU.

P. S. Sankar
Signature



TRAINING PROGRAMME FEEDBACK FORM

Name of the Student: R. Senthosh Kumar

Branch: B.TECH-IT

Year / Sem: II yr / III sem

functions
structure

1. Name of the Training: Programming in c

2. Name of the Trainer: Nandagopal

3. Students rating of Trainers :

S. No.	Date	Subject	Rating (√)			
			Excellent	Very good	Good	Average
1	12.06.18	programming in c		✓		

4. Two positive points about the programme: *) we have done most of the programmes
*) level of teaching by staff was good

5. Suggestions for improvement: *) apart from basics, many new and advanced concepts can be taught with practice

R. Senthosh Kumar
Signature

Date: 12.06.18



TRAINING PROGRAMME FEEDBACK FORM

Name of the Student: M. GOBIKA

Branch: IT

Year / Sem: II / III

4. Name of the Training: Programming in c

5. Name of the Trainer: Nandagopal

6. Students rating of Trainers :

S. No.	Date	Subject	Rating (√)			
			Excellent	Very good	Good	Average
1	12.06.18	PROGRAMMING IN C		✓		

4. Two positive points about the programme: In this class, we got the basic ideas about the programming language. Recalling of the basics made us to get clear ideas which is the beginning to our programming skill.

5. Suggestions for improvement:

Exercises to get practised.

Date: 12.06.18

M. Gobika
Signature
K. S. R. KALVI NAGAR,
TIRUCHENGODE-637 215,
NAMAKKAL DISTRICT, TAMIL NADU.

**K S R INSTITUTE FOR ENGINEERING AND TECHNOLOGY
TIRUCHENGODE - 637 215**

TRAINING PROGRAMME FEEDBACK FORM



Name of the Student: ARUN KUMAR S

Branch: B.E - Mech - "A"

Year / Sem: II / 3-sem

1.Name of the Training :

2.Name of the Trainer :

3.Students rating of Trainers :

S. No.	Date	Subject	Rating (✓)			
			Excellent	Very good	Good	Average
1	13.06.2018	CSC	✓			

4. Two positive points about the programme: we have learnt new language
It will help us to improve our programming skills.

5. Suggestions for improvement:

the class can held more in the lab.

S. Arun
Signature

Date:

**K S R INSTITUTE FOR ENGINEERING AND TECHNOLOGY
TIRUCHENGODE - 637 215**

TRAINING PROGRAMME FEEDBACK FORM



Name of the Student: Ajith Kumar R

Branch: B.E - mech - "A"

Year / Sem: II / 3-sem

4.Name of the Training :

5.Name of the Trainer :

6.Students rating of Trainers :

S. No.	Date	Subject	Rating (✓)			
			Excellent	Very good	Good	Average
1	13.06.2018	CSC	✓			

4. Two positive points about the programme: we have learnt new language.
It will help us to improve our programming skills.

5. Suggestions for improvement:

the class can held more in the lab.

K. S. R. INSTITUTE FOR
ENGINEERING AND TECHNOLOGY
K. S. R. KALVI NAGAR,
TIRUCHENGODE-637 215,
NAMAKKAL Dt, TAMIL NADU.

A. Arun
Signature

Date:

**K S R INSTITUTE FOR ENGINEERING AND TECHNOLOGY
TIRUCHENGODE - 637 215**

TRAINING PROGRAMME FEEDBACK FORM



Name of the Student: C. Mohanaraj

Branch: Mech - R

Year / Sem: II / III

1. Name of the Training: Soft Skills

2. Name of the Trainer: Sathyavriya

3. Students rating of Trainers: 4/5

S. No.	Date	Subject	Rating (√)			
			Excellent	Very good	Good	Average
1	13/6/18	C Programming	✓			

4. Two positive points about the programme:

- i) Good in teaching
- ii) Good communication.

5. Suggestions for improvement:

- i) Applications needed

Date: 13/6/18 - FN

C. Mohanaraj

Signature

**K S R INSTITUTE FOR ENGINEERING AND TECHNOLOGY
TIRUCHENGODE - 637 215**

TRAINING PROGRAMME FEEDBACK FORM



Name of the Student: R. Saravanan

Branch: Mech - B

Year / Sem: II / IV

4. Name of the Training: Soft Skills

5. Name of the Trainer: Sathyavriya

6. Students rating of Trainers: 4/5

S. No.	Date	Subject	Rating (√)			
			Excellent	Very good	Good	Average
1	13/6/18	C Programming	✓			

4. Two positive points about the programme:

- i) Good in teaching
- ii) Good communication

5. Suggestions for improvement:

- (i) Applications needed.

Date: 13/6/18 - AN

PRINCIPAL,
 K. S. R. INSTITUTE FOR
 ENGINEERING AND TECHNOLOGY,
 K. S. R. KALVI NAGAR,
 TIRUCHENGODE-637 215,
 NAMAKKAL DI, TAMIL NADU.

R. Saravanan

Signature



Name of the Student: J.P. Jessica Collins

Branch: B.Tech/IT

Year / Sem: II / III

1. Name of the Training: APS Skill

2. Name of the Trainer: Mr. Vijayaraj Sir

3. Students rating of Trainers :

S. No.	Date	Subject	Rating (✓)			
			Excellent	Very good	Good	Average
1	13.6.18	maths	✓			

TOPIC - Time & work, pipes and cisterns, time, speed distance

4. Two positive points about the programme:
 • Was very easy to cope up with
 • PPT was useful.

5. Suggestions for improvement: -

Date: 13.6.18

Signature J.P.



Name of the Student: R. Dhanush Adit

Branch: B. tech/IT

Year / Sem: II / III

4. Name of the Training: APS skill

5. Name of the Trainer: Mr. Vijayaraj Sir

6. Students rating of Trainers :

S. No.	Date	Subject	Rating (✓)			
			Excellent	Very good	Good	Average
1	13.6.18	maths	✓			

Topic - Time and work, pipes and cisterns, time, speed distance

4. Two positive points about the programme:
 * PPT presentation was very good

5. Suggestions for improvement:
 we want more example

every each topics

Date: 13.6.18

PRINCIPAL.
K. S. R. INSTITUTE FOR
ENGINEERING AND TECHNOLOGY,
K. S. R. KALVI NAGAR,
TIRUCHENGODE-637 215.
NAMAKKAL, Dt, TAMIL NADU.
Signature R. Dhanush

**K S R INSTITUTE FOR ENGINEERING AND TECHNOLOGY
TIRUCHENGODE - 637 215**

TRAINING PROGRAMME FEEDBACK FORM



Name of the Student: THANESHWARAN.Y.G Branch: IT / IInd Year

Year / Sem: 2nd Year / 3rd Sem

1. Name of the Training: Aptitude Skill training

2. Name of the Trainer: Mr. S. Vijayaraj

3. Students rating of Trainers :

S. No.	Date	Subject	Rating (√)			
			Excellent	Very good	Good	Average
1	14.06.18	Aptitude		✓		

4. Two positive points about the programme:

we learn all the 6 topics

5. Suggestions for improvement:

NO

Thanesw Y.G
Signature

Date: 14, 06, 2018

**K S R INSTITUTE FOR ENGINEERING AND TECHNOLOGY
TIRUCHENGODE - 637 215**

TRAINING PROGRAMME FEEDBACK FORM



Name of the Student: Sreemathi Indira Branch: IT

Year / Sem: 2 / 3rd sem

4. Name of the Training: Aptitude

5. Name of the Trainer: Mr. S. Vijayaraj

6. Students rating of Trainers :

S. No.	Date	Subject	Rating (√)			
			Excellent	Very good	Good	Average
1	14/06/2018	Maths	✓			

4. Two positive points about the programme:

After explaining work out of sums is useful. and concepts

5. Suggestions for improvement:

Some problems
K. S. R. INSTITUTE FOR ENGINEERING AND TECHNOLOGY
K. S. R. KALVI NAGAR,
TIRUCHENGODE-637 215,
NAMAKKAL Dt, TAMIL NADU.

S. Sreemathi Indira
Signature

Date: 14 06 - 2018

K S R INSTITUTE FOR ENGINEERING AND TECHNOLOGY
TIRUCHENGODE - 637 215

TRAINING PROGRAMME FEEDBACK FORM



Name of the Student: S. BALAJI

Branch: MECH - A

Year / Sem: 2nd - 3rd sem

1. Name of the Training: BASIC PROGRAMMING SKILLS IN C.

2. Name of the Trainer: PRAKASAM

3. Students rating of Trainers :

S. No.	Date	Subject	Rating (√)			
			Excellent	Very good	Good	Average
1	<u>14.06.18</u>		✓			

4. Two positive points about the programme:

* Very useful & I more learnt about c programming

5. Suggestions for improvement:

We want more class for programming in system.

Date: 14.06.2018.

S. Balaji
Signature

K S R INSTITUTE FOR ENGINEERING AND TECHNOLOGY
TIRUCHENGODE - 637 215

TRAINING PROGRAMME FEEDBACK FORM



Name of the Student: C.M. DHARSHAN

Branch: MECH - A

Year / Sem: 2nd yr - 3rd sem.

4. Name of the Training: BASIC PROGRAMMING SKILLS IN C.

5. Name of the Trainer: PRAKASAM.

6. Students rating of Trainers :

S. No.	Date	Subject	Rating (√)			
			Excellent	Very good	Good	Average
1	<u>14-06-18</u>		✓			

4. Two positive points about the programme:

Very useful, I learnt more about c program

5. Suggestions for improvement:

We want more class for programming in laborator

Date: 14-06-2018

Signature

C.M. Dharshan



Name of the Student: MUNEESSWARAN. D

Branch: RE / MECHANICAL

Year / Sem: II / III

1. Name of the Training : Communication Skill

2. Name of the Trainer : Mugurtharaj

3. Students rating of Trainers :

S. No.	Date	Subject	Rating (✓)			
			Excellent	Very good	Good	Average
1	18/06/18	Communication		✓		

4. Two positive points about the programme:

- 1) Given more knowledge about communication English
- 2) To know how to speak simple English

5. Suggestions for improvement:

NIL.

Date: 18/06/18

Signature
[Signature]



Name of the Student: M. Monish Kanna

Branch: B.E / MECH.

Year / Sem: 2nd / 3rd

4. Name of the Training : placement training

5. Name of the Trainer : C. Mugurtharaj

6. Students rating of Trainers :

S. No.	Date	Subject	Rating (✓)			
			Excellent	Very good	Good	Average
1	18.06.18/A.N	Communication English	✓			

4. Two positive points about the programme:

- * developed English knowledge.
- * Sir tells very interesting points and facts It is useful.

5. Suggestions for improvement:

NIL.

Date: 18.06.2018

PRINCIPAL.
K. S. R. INSTITUTE FOR
ENGINEERING AND TECHNOLOGY,
K. S. R. KALVI NAGAR,
TIRUCHENGODE-637 215,
NAMAKKAL DI, TAMIL NADU.

Signature
[Signature]

**K S R INSTITUTE FOR ENGINEERING AND TECHNOLOGY
TIRUCHENGODE - 637 215**

TRAINING PROGRAMME FEEDBACK FORM



Name of the Student: J. Ruban Prasad

Branch: ECE

Year / Sem: II yr / 2

1. Name of the Training: C programming

2. Name of the Trainer: LAVANYA

3. Students rating of Trainers :

S. No.	Date	Subject	Rating (√)			
			Excellent	Very good	Good	Average
1	18/6/18	C programming		✓		

4. Two positive points about the programme: Very Usefull
Good teaching

5. Suggestions for improvement:

Nil

Date: 18/6/18

[Signature]

Signature

**K S R INSTITUTE FOR ENGINEERING AND TECHNOLOGY
TIRUCHENGODE - 637 215**

TRAINING PROGRAMME FEEDBACK FORM



Name of the Student: S. Ramya

Branch: ECE

Year / Sem: II / 02

4. Name of the Training: c programming

5. Name of the Trainer: Lavanya

6. Students rating of Trainers :

S. No.	Date	Subject	Rating (√)			
			Excellent	Very good	Good	Average
1	18.6.18	c programming			✓	

4. Two positive points about the programme: 1) Good conveying to students
2) very useful

5. Suggestions for improvement: Nil

Date: 18.6.18

K. S. R. INSTITUTE FOR
ENGINEERING AND TECHNOLOGY,
K. S. R. KALVI NAGAR,
TIRUCHENGODE-637 215,
NAMAKKAL DISTRICT, TAMIL NADU.

[Signature]

Signature

K S R INSTITUTE FOR ENGINEERING AND TECHNOLOGY
TIRUCHENGODE - 637 215

TRAINING PROGRAMME FEEDBACK FORM



Name of the Student: Gnanatham, M. Branch: ECE - A

Year / Sem: II / III

1. Name of the Training: Programming in C.
 2. Name of the Trainer: Bala Krishnan.
 3. Students rating of Trainers: 8/10.

S. No.	Date	Subject	Rating (√)			
			Excellent	Very good	Good	Average
1	18.6.18	Programming in C.		✓		

4. Two positive points about the programme:
 * He is so friendly
 * His teaching is understood by me.

5. Suggestions for improvement:
 * To Repeat some difficulties.

Date: _____ Signature: _____

K S R INSTITUTE FOR ENGINEERING AND TECHNOLOGY
TIRUCHENGODE - 637 215

TRAINING PROGRAMME FEEDBACK FORM



Name of the Student: S. Hemalatha Branch: BCE - A

Year / Sem: II / III

4. Name of the Training: Programming in C
 5. Name of the Trainer: Balakrishnan
 6. Students rating of Trainers: 8.5/10

S. No.	Date	Subject	Rating (√)			
			Excellent	Very good	Good	Average
1	18.6.18	Programming in C		✓		

4. Two positive points about the programme:
 * His teaching was understood by all.
 * His coaching in lab was excellent.

5. Suggestions for improvement:
 * Explanation of program has to be improved.

Date: _____ Signature: _____
 PRINCIPAL,
 K. S. R. INSTITUTE FOR
 ENGINEERING AND TECHNOLOGY,
 K. S. R. KALVI NAGAR,
 TIRUCHENGODE-637 215
 NAMAKKAL DI, TAMIL NADU.



Name of the Student: T. Janani Branch: IT

Year / Sem: III/05

1. Name of the Training : Industrial Readiness program

2. Name of the Trainer : Dr. Nandhakumar

3. Students rating of Trainers :

S. No.	Date	Subject	Rating (✓)			
			Excellent	Very good	Good	Average
1	19.06.18	Training program	✓			

4. Two positive points about the programme: 1) very motivational
2) Interactive session

5. Suggestions for improvement: NIL

Date: 20/6/18

[Signature]
Signature



Name of the Student: J. Kowsalya Branch: IT

Year / Sem: III/05

4. Name of the Training : Industrial Readiness Program

5. Name of the Trainer : Dr. Nandhakumar

6. Students rating of Trainers :

S. No.	Date	Subject	Rating (✓)			
			Excellent	Very good	Good	Average
1	19.6.18	Training Program	✓			

4. Two positive points about the programme: 1) We learn lot about our career.
2) Motivational talk.

5. Suggestions for improvement: NIL

Date: 20/6/18

[Signature]
PRINCIPAL,
K S R INSTITUTE FOR
ENGINEERING AND TECHNOLOGY,
K. S. R. KALVI NAGAR,
TIRUCHENGODE-637 215,
NAMAKKAL Dt, TAMIL NADU,

Signature

**K S R INSTITUTE FOR ENGINEERING AND TECHNOLOGY
TIRUCHENGODE – 637 215**

TRAINING PROGRAMME FEEDBACK FORM



Name of the Student: S.S. NAVEEN Branch: ECE

Year / Sem: II yr / 3

1. Name of the Training : C programming

2. Name of the Trainer : LAVANYA

3. Students rating of Trainers : 9/10

S. No.	Date	Subject	Rating (√)			
			Excellent	Very good	Good	Average
1	19/6/18	C programming		✓		

4. Two positive points about the programme: (i) Method of teaching is Nice
(ii) Problem Solving Methodology is easy

5. Suggestions for improvement:

Nil

Date: 19/6/18

[Signature]
Signature

**K S R INSTITUTE FOR ENGINEERING AND TECHNOLOGY
TIRUCHENGODE – 637 215**

TRAINING PROGRAMME FEEDBACK FORM



Name of the Student: Priga R Branch: FCE

Year / Sem: II yr / 3

4. Name of the Training : C Programming

5. Name of the Trainer : LAVANYA

6. Students rating of Trainers : 9/10

S. No.	Date	Subject	Rating (√)			
			Excellent	Very good	Good	Average
1	19/6/18	C Programming		✓		

4. Two positive points about the programme: (i) Explanation of Program is nice
(ii) Programs were made simple.

5. Suggestions for improvement:

NIL

Date: 19/6/18

[Signature]
Signature
K. S. R. INSTITUTE FOR ENGINEERING AND TECHNOLOGY,
K. S. R. KALVI NAGAR,
TIRUCHENGODE-637 215,
NAMAKKAL DISTRICT, TAMIL NADU.



Name of the Student: P. Sakthivel

Branch: BE - EEE

Year / Sem: II / III

4. Name of the Training: Vijaya Raj

5. Name of the Trainer:

6. Students rating of Trainers:

S. No.	Date	Subject	Rating (√)			
			Excellent	Very good	Good	Average
1	25.6.2018	maths aptitude		✓		

4. Two positive points about the programme: Good and interest

5. Suggestions for improvement: Need more explanation

Date: 25.6.2018

P. Sakthivel
Signature



Name of the Student: P. Ramya

Branch: B. E, EEE

Year / Sem: 2018/3rd

1. Name of the Training: aptitude Test

2. Name of the Trainer: Vijaya Raj

3. Students rating of Trainers:

S. No.	Date	Subject	Rating (√)			
			Excellent	Very good	Good	Average
1	25/6/18	aptitude.	✓			

4. Two positive points about the programme: Very Useful for placement training

5. Suggestions for improvement:

**K S R INSTITUTE FOR ENGINEERING AND TECHNOLOGY
TIRUCHENGODE - 637 215**

TRAINING PROGRAMME FEEDBACK FORM



Name of the Student: S. Hemalatha

Branch: ECE - A

Year / Sem: II / III

1. Name of the Training : Programming in C

2. Name of the Trainer : Balakerishnan

3. Students rating of Trainers : 8 / 10

S. No.	Date	Subject	Rating (√)			
			Excellent	Very good	Good	Average
1	19/6/18			✓		

4. Two positive points about the programme:

* His teaching was very good

* Understanding level of students was nice

5. Suggestions for improvement:

Teaching programming in C has to be improved.

Date: 19/6/18

S. Hemalatha
Signature

**K S R INSTITUTE FOR ENGINEERING AND TECHNOLOGY
TIRUCHENGODE - 637 215**

TRAINING PROGRAMME FEEDBACK FORM



Name of the Student: G. Geetha Rani

Branch: ECE - A

Year / Sem: II / III

4. Name of the Training : Programming in C

5. Name of the Trainer : Balakerishnan

6. Students rating of Trainers : 8.5 / 10

S. No.	Date	Subject	Rating (√)			
			Excellent	Very good	Good	Average
1	19/6/18				✓	

4. Two positive points about the programme:

* His teaching was good

* Way of approaching was nice

5. Suggestions for improvement:

Explanation of

Date: 19/6/18

PRINCIPAL
 K. S. R. INSTITUTE FOR
 ENGINEERING AND TECHNOLOGY,
 TIRUCHENGODE - 637 215
 NAMAKKAL Dt, TAMIL NADU.

improved
G. Geetha Rani
Signature

K S R INSTITUTE FOR ENGINEERING AND TECHNOLOGY
TIRUCHENGODE - 637 215

TRAINING PROGRAMME FEEDBACK FORM



Name of the Student: M. Kavi raj Branch: MECH

Year / Sem: II / 03

1. Name of the Training : Maths
2. Name of the Trainer : vijayaraj
3. Students rating of Trainers :

S. No.	Date	Subject	Rating (√)			
			Excellent	Very good	Good	Average
1	19.06.18	Maths	✓			

4. Two positive points about the programme:

content delivery very nice
easily understand.

5. Suggestions for improvement:

NO Suggestion.

Date: 19.06.18

M. Kavi Raj
Signature

K S R INSTITUTE FOR ENGINEERING AND TECHNOLOGY
TIRUCHENGODE - 637 215

TRAINING PROGRAMME FEEDBACK FORM



Name of the Student: Kirubakaran.K. Branch: MECH

Year / Sem: II / 03

4. Name of the Training : Maths
5. Name of the Trainer : Vijayaraj
6. Students rating of Trainers :

S. No.	Date	Subject	Rating (√)			
			Excellent	Very good	Good	Average
1	19.06.18	Maths		✓		

4. Two positive points about the programme:

Smart class
very useful
easily understand.

5. Suggestions for improvement:

No suggestions

PRINCIPAL,
K. S. R. INSTITUTE FOR
ENGINEERING AND TECHNOLOGY,
K. S. R. KALVI NAGAR,
TIRUCHENGODE-637 215,
NAMAKKAL Dt. TAMIL NADU.

Date: 19.06.2018

Vijayaraj
Signature



Name of the Student: VINOTHICUMAR . T

Branch: MECH ' B'

Year / Sem: I / III

1. Name of the Training : Placement Training

2. Name of the Trainer : Mukuntharajan

3. Students rating of Trainers :

S. No.	Date	Subject	Rating (√)			
			Excellent	Very good	Good	Average
1	20/06/18 FN	Communication English	✓			

4. Two positive points about the programme:

- * I develop the speaking knowledge.
- * AND speak well.

5. Suggestions for improvement:

- * weekly once need this type of program.

Date: 20/06/18.

J. Prudhvi
Signature



Name of the Student: NAPESH.

Branch: MECHANICAL

Year / Sem: II / III

4. Name of the Training : Communication

5. Name of the Trainer : Mutharajan . C

6. Students rating of Trainers :

S. No.	Date	Subject	Rating (√)			
			Excellent	Very good	Good	Average
1	20.6.2018 AN	Communication English	✓			

4. Two positive points about the programme:

- * Too good to improve my knowledge.
- * Best experience with teaching skills.

5. Suggestions for improvement:

- should be made by performed trainer

Date: 20.06.2018

[Signature]
PRINCIPAL,
K. S. R. INSTITUTE FOR
ENGINEERING AND TECHNOLOGY,
K. S. R. KALVI NAGAR, Signature
TIRUCHENGODE-637 215,
NAMAKKAL DL, TAMIL NADU.



Name of the Student: G. Kamalahasan

Branch: EEE

Year / Sem: II / III

1. Name of the Training: BASIC COMMUNICATION SKILL

2. Name of the Trainer: C. ~~MUNTHARAJAN~~ MUHUNTHARAJAN

3. Students rating of Trainers :

S. No.	Date	Subject	Rating (✓)			
			Excellent	Very good	Good	Average
1	21-6-18	ENGLISH	✓			

4. Two positive points about the programme: i) Basic communication is learned.
ii) We have form a team.

5. Suggestions for improvement:

Nothing

G. Kamalahasan
Signature

Date: 21-6-18



Name of the Student: R. ASHA

Branch: B- E EEE

Year / Sem: II / III

4. Name of the Training: Basic Communication Skills.

5. Name of the Trainer: Dr. C. Muhuntharajan.

6. Students rating of Trainers :

S. No.	Date	Subject	Rating (✓)			
			Excellent	Very good	Good	Average
1	21-6-18	Listening Skills, speaking.	✓			

4. Two positive points about the programme: i) Make Everyone to share their ideas in simple English.
ii) Encouraged students to speak English.

5. Suggestions for improvement:

More Interactions.

Asharaj
Signature

Date: 21-6-18



Name of the Student: N. MOHANAPREYF

Branch: B.E - CSE

Year / Sem: II (II)

1. Name of the Training : APTITUDE TRAINING

2. Name of the Trainer : M.S. VISAYARAJ

3. Students rating of Trainers :

S. No.	Date	Subject	Rating (✓)			
			Excellent	Very good	Good	Average
1	21.6.18	aptitude training	✓			

4. Two positive points about the programme:

able to learn many different topics

5. Suggestions for improvement:

getting thorough in the topics helps to gain knowledge.

Extend the class for one more day

N. Mohanofj.
Signature

Date: 21.6.18



Name of the Student: J. Deepak Kumar

Branch: CSE

Year / Sem: II (II)

4. Name of the Training : APTITUDE TRAINING

5. Name of the Trainer : Ms. Vijayaraj

6. Students rating of Trainers : Good

S. No.	Date	Subject	Rating (✓)			
			Excellent	Very good	Good	Average
1	21.6.18	Maths			✓	

4. Two positive points about the programme:

Thinking and calculating

5. Suggestions for improvement:

Clear and good speech

Date: 21.6.18

PRINCIPAL
K. S. R. INSTITUTE FOR
ENGINEERING AND TECHNOLOGY
K. S. R. KALVI NAGAR,
TIRUCHENGODE-637 215,
NAMAKKAL DI, TAMIL NADU.

J. Deepak
Signature

TIRUCHENGODE - 637 215
 TRAINING PROGRAMME FEEDBACK FORM



Name of the Student: A. RAMYA Branch: RE EEE

Year / Sem: 2nd Year - 3rd Sem

1. Name of the Training: communication skill

2. Name of the Trainer :

3. Students rating of Trainers :

S. No.	Date	Subject	Rating (✓)			
			Excellent	Very good	Good	Average
1	22-06-2018	English	✓			

4. Two positive points about the programme:

* It is very interesting and learn more
 *

5. Suggestions for improvement:

I try to talk to speak in english here
 Signature: A. Ramya

Date: 22-06-2018

K S R INSTITUTE FOR ENGINEERING AND TECHNOLOGY
 TIRUCHENGODE - 637 215
 TRAINING PROGRAMME FEEDBACK FORM



Name of the Student: K. Karim muthu Kumar Branch: RE EEE

Year / Sem: II / III

4. Name of the Training: Basic communication skills

5. Name of the Trainer: M. Muthuvarjan

6. Students rating of Trainers :

S. No.	Date	Subject	Rating (✓)			
			Excellent	Very good	Good	Average
1	22.06.18	English	✓			

4. Two positive points about the programme:

* It is very useful.
 * It is very interesting.

5. Suggestions for improvement:

The duration of the program ✓

Date: is less. it should be increased

22-06-18

Signature: [Signature]

PRINCIPAL:
 K. S. R. INSTITUTE FOR
 ENGINEERING AND TECHNOLOGY,
 K. S. R. KALVI NAGAR,
 TIRUCHENGODE-637 215,
 NAMAKKAL Dt, TAMIL NADU.

TIRUCHENGODE - 637 215
TRAINING PROGRAMME FEEDBACK FORM



Name of the Student: M. Gobiika

Branch: IT/B. Tech

Year / Sem: I / 03

1. Name of the Training : COMMUNICATIVE SKILLS

2. Name of the Trainer : MUGUNTHARAJAN - C

3. Students rating of Trainers :

S. No.	Date	Subject	Rating (✓)			
			Excellent	Very good	Good	Average
1	25.06.18	ENGLISH		✓		

4. Two positive points about the programme: The training was entirely useful to make us strong in the communication side. New innovative thoughts and ideas was gained.

5. Suggestions for improvement: The training was entirely good and these are no more suggestions.

Date: 25.06.18

KSR
Signature

K S R INSTITUTE FOR ENGINEERING AND TECHNOLOGY
TIRUCHENGODE - 637 215
TRAINING PROGRAMME FEEDBACK FORM



Name of the Student: G. Mounish

Branch: B-Tech /IT

Year / Sem: I / 03

4. Name of the Training : COMMUNICATIVE SKILLS

5. Name of the Trainer : MUGUNTHARAJAN - C

6. Students rating of Trainers :

S. No.	Date	Subject	Rating (✓)			
			Excellent	Very good	Good	Average
1	25.06.18	English	✓			

4. Two positive points about the programme: The training was very effective to learn so many things

5. Suggestions for improvement: Maintain the same improvement on tomorrow.

Date: 25.06.18.

G. Mounish
Signature

PRINCIPAL.
K. S. R. INSTITUTE FOR
ENGINEERING AND TECHNOLOGY,
K. S. R. KALVI NAGAR,
TIRUCHENGODE-637 215,
NAMAKKAL Dt, TAMIL NADU.

TIRUCHENGODE - 637 215
TRAINING PROGRAMME FEEDBACK FORM



Name of the Student: Lakshmanan

Branch: B.Tech IT

Year / Sem: II / III

1. Name of the Training: Dr. Muguntharaj Communication skill

2. Name of the Trainer: Dr. C. Muguntharaj

3. Students rating of Trainers :

S. No.	Date	Subject	Rating (✓)			
			Excellent	Very good	Good	Average
1	26.06.18	communication skill	✓			

4. Two positive points about the programme: Sir taught to us, how to improve our communication skills in multi way. Sir, gave us lot and lot of activity to improve communication, these sir gave to us are very good...

5. Suggestions for improvement:

No suggestions.

Date:

Sir taught us in good way.

D. Laksh
Signature

K S R INSTITUTE FOR ENGINEERING AND TECHNOLOGY
TIRUCHENGODE - 637 215
TRAINING PROGRAMME FEEDBACK FORM



Name of the Student: Gobika M.

Branch: B.Tech /IT

Year / Sem: II / III

4. Name of the Training: communicative skill

5. Name of the Trainer: Dr. C. Muguntharaj

6. Students rating of Trainers :

S. No.	Date	Subject	Rating (✓)			
			Excellent	Very good	Good	Average
1	26.06.18	communicative skill	✓			

4. Two positive points about the programme: The training brought us many innovative thinkings to improve the communicative skills. Many activities that gave us enough stuff to improve ourself.

5. Suggestions for improvement:

I hope the training was more over good

Date: 26.06.18

PRINCIPAL,
K. S. R. INSTITUTE FOR
ENGINEERING AND TECHNOLOGY,
K. S. R. KALVI NAGAR,
TIRUCHENGODE-637 215,
NAMAKKAL DT. TAMIL NADU.

N. Gobika
Signature

K S R INSTITUTE FOR ENGINEERING AND TECHNOLOGY
TIRUCHENGODE - 637 215
TRAINING PROGRAMME FEEDBACK FORM



Name of the Student: S. HEMALATHA Branch: B.E - EEE

Year / Sem: II / III

1. Name of the Training: Basic Aptitude Skill

2. Name of the Trainer: Vijayaraj

3. Students rating of Trainers :

S. No.	Date	Subject	Rating (✓)			
			Excellent	Very good	Good	Average
1	26-06-18	Basic Aptitude Skill		✓		

4. Two positive points about the programme: We are allowed to solve the problems

5. Suggestions for improvement: Give more problems to improve our skills

Date: 26-06-18

[Signature]
Signature

K S R INSTITUTE FOR ENGINEERING AND TECHNOLOGY
TIRUCHENGODE - 637 215
TRAINING PROGRAMME FEEDBACK FORM



Name of the Student: S. Kavin Muthu Kumar Branch: B.E

Year / Sem: II / III

4. Name of the Training: Basic Aptitude skills.

5. Name of the Trainer: Vijayaraj

6. Students rating of Trainers :

S. No.	Date	Subject	Rating (✓)			
			Excellent	Very good	Good	Average
1	26-06-18	Basic Aptitude Skill	✓			

4. Two positive points about the programme: It is interesting.
It is easy to understand.

5. Suggestions for improvement:

Time is insufficient.

Date: 26-06-18

PRINCIPAL,
K. S. R. INSTITUTE FOR
ENGINEERING AND TECHNOLOGY,
K. S. R. KALVI NAGAR,
TIRUCHENGODE-637 215,
NAMAKKAL DI, TAMIL NADU.

[Signature]
Signature

**K S R INSTITUTE FOR ENGINEERING AND TECHNOLOGY
TIRUCHENGODE – 637 215**

TRAINING PROGRAMME FEEDBACK FORM



Name of the Student: Kishor - M

Branch: ECE

Year / Sem: II / III
A

1.Name of the Training : Communication Skills

2.Name of the Trainer : C. Muthurajan

3.Students rating of Trainers : 9/10

S. No.	Date	Subject	Rating (√)			
			Excellent	Very good	Good	Average
1	28.6.18	Communication Skills	✓			

4. Two positive points about the programme:
 - Essential for Interview
 - Understandable

5. Suggestions for improvement:

Date: 28.6.18

Kishor M
Signature

**K S R INSTITUTE FOR ENGINEERING AND TECHNOLOGY
TIRUCHENGODE – 637 215**

TRAINING PROGRAMME FEEDBACK FORM



Name of the Student: Hemalatha S

Branch: ECE

Year / Sem: II / III
A

4.Name of the Training : Communication skills

5.Name of the Trainer : C. Muthurajan

6.Students rating of Trainers : 9.5/10

S. No.	Date	Subject	Rating (√)			
			Excellent	Very good	Good	Average
1	28.6.18	Communication Skills	✓			

4. Two positive points about the programme: - Useful

5. Suggestions for improvement:

Date: 28.6.18

PRINCIPAL.
K. S. R. INSTITUTE FOR
ENGINEERING AND TECHNOLOGY,
K. S. R. KALVI NAGAR,
TIRUCHENGODE-637 215,
NAMAKKAL DI, TAMIL NADU.

Hemalatha S
Signature



Name of the Student: SUKHESANE Branch: ECE

Year / Sem: II / III

1. Name of the Training: APTITUDE

2. Name of the Trainer: VIJAYARAJ

3. Students' rating of Trainers :

S. No.	Date	Subject	Rating (✓)			
			Excellent	Very good	Good	Average
1	28.06.18	APTITUDE		✓		

4. Two positive points about the programme: I have improved my Aptitude knowledge.

5. Suggestions for improvement: No.

Date: 28.08.18

[Signature]
Signature



Name of the Student: V. Raghu Ramachandra Branch: ECE

Year / Sem: II - III Sem

4. Name of the Training: APTITUDE

5. Name of the Trainer: Vijayaraj

6. Students' rating of Trainers :

S. No.	Date	Subject	Rating (✓)			
			Excellent	Very good	Good	Average
1	28.06.18	Aptitude		✓		

4. Two positive points about the programme: It is used to solve the problem easily.

5. Suggestions for improvement: No

Date: 28.08.18

PRINCIPAL
K. S. R. INSTITUTE FOR
ENGINEERING AND TECHNOLOGY,
K. S. R. KALVI NAGAR,
TIRUCHENGODE-637 215,
NAMAKKAL Dt, TAMIL NADU.

[Signature]
Signature



Name of the Student: R. Priya Branch: ECE

Year / Sem: V / III

1. Name of the Training : Aptitude

2. Name of the Trainer : Vijayaraj

3. Students rating of Trainers : 10/10

S. No.	Date	Subject	Rating (√)			
			Excellent	Very good	Good	Average
1	29/06/18	Aptitude		✓		

4. Two positive points about the programme:

Easy to solve the Problem

5. Suggestions for improvement:

NIL

Date: 29/06/18

R. Priya
Signature



Name of the Student: SINDHUTA Branch: ECE

Year / Sem: V / III

4. Name of the Training : Aptitude

5. Name of the Trainer : Vijayaraj

6. Students rating of Trainers :

S. No.	Date	Subject	Rating (√)			
			Excellent	Very good	Good	Average
1	29/06/18	Aptitude		✓		

4. Two positive points about the programme:

We are able to do problems shortly and easily and it improved logical thinking.

5. Suggestions for improvement:

NIL

Date: 29/6/18

PRINCIPAL,
K. S. R. INSTITUTE FOR
ENGINEERING AND TECHNOLOGY,
K. S. R. KALVI NAGAR, Signature Sindhuta
TIRUCHENGODE-637 215,
NAMAKKAL Dt, TAMIL NADU.



Name of the Student: R. Hari Hara Sudhan

Branch: ECE - A

Year / Sem: 2nd / 3rd

1. Name of the Training: COMMUNICATION SKILLS

2. Name of the Trainer: C. MUHUNTHARAJAN

3. Students rating of Trainers: 10

S. No.	Date	Subject	Rating (✓)			
			Excellent	Very good	Good	Average
1	29/8/2018	COMMUNICATION SKILLS	✓			

4. Two positive points about the programme:

His class can't bore

His class is useful for remove our stage fear

5. Suggestions for improvement:

Date: 29/8/2018

R. Hari Hara Sudhan
Signature



Name of the Student: N. DHANUSHKODI

Branch: ECE - A

Year / Sem: 2nd / 3rd

4. Name of the Training: C. MUHUNTHARAJAN

5. Name of the Trainer: Communication skills

6. Students rating of Trainers: 10

S. No.	Date	Subject	Rating (✓)			
			Excellent	Very good	Good	Average
1	29/6/18	Communication skills	✓			

4. Two positive points about the programme:

* our class was so Excitement.

* It is useful for placement

5. Suggestions for improvement:

Date: 29/6/18

PRINCIPAL,
K. S. R. INSTITUTE FOR
ENGINEERING AND TECHNOLOGY,
K. S. R. KALVI NAGAR,
TIRUCHENGODE - 637 215,
NAMAKKAL DI, TAMIL NADU.

N. 2
Signature



Name of the Student: F. Arun Kumar Branch: Mech - A.

Year / Sem: II Year / II sem.

4. Name of the Training: Placement training [English].

5. Name of the Trainer: C. Muguntharajan

6. Students rating of Trainers :

S. No.	Date	Subject	Rating (✓)			
			Excellent	Very good	Good	Average
1	3.7.18	English	✓			

4. Two positive points about the programme: *) To learn communicative skills.

*) To learn more general knowledge

5. Suggestions for improvement:

Date: 3.7.18

Signature

F. Arun Kumar



Name of the Student: R. Govindharasan Branch: Mechanical.

Year / Sem: II years / II sem

1. Name of the Training: placement training (english)

2. Name of the Trainer: muguntharajan

3. Students rating of Trainers :

S. No.	Date	Subject	Rating (✓)			
			Excellent	Very good	Good	Average
1	3.7.18	English	✓			

PRINCIPAL.

4. Two positive points about the programme: INSTITUTE FOR
1) Visual to see ENGINEERING AND TECHNOLOGY,

(ii) Improve the knowledge
K. S. R. KALVINAGAR,
TIRUCHENGODE - 637 215,

5. Suggestions for improvement:

NAMAKKAL DI, TAMIL NADU.

*

Date: 3.7.18

R. Govindharasan
Signature



Name of the Student: NAVEEN. V

Branch: MECHANICAL

Year / Sem: I Year, II sec.

1. Name of the Training: APTITUDE

2. Name of the Trainer: Vi Jayarajan

3. Students rating of Trainers :

S. No.	Date	Subject	Rating (√)			
			Excellent	Very good	Good	Average
1	3/7/18	APTITUDE			✓	

4. Two positive points about the programme:

- * It was very useful.
- * The problem learn learn easily

5. Suggestions for improvement:

- * Give some activity at the centre of class

Date: 3/7/18

Naveen V
Signature



Name of the Student: PRAGIATHEESWAR.E

Branch: MECHANICAL

Year / Sem: II - Year, III sec

4. Name of the Training: APTITUDE

5. Name of the Trainer: Vi Jayarajan

6. Students rating of Trainers :

S. No.	Date	Subject	Rating (√)			
			Excellent	Very good	Good	Average
1	3/7/18	APTITUDE	✓			

4. Two positive points about the programme:

- * It is very useful to develop our knowledge
- * It is very interesting to listen

5. Suggestions for improvement:

- * There is no suggestions for my side.

Date:

Pr
PRINCIPAL,
K. S. R. INSTITUTE FOR
ENGINEERING AND TECHNOLOGY,
K. S. R. KALVI NAGAR,
TIRUCHENGODE-637 215,
NAMAKKAL DI, TAMIL NADU.

Pr
Signature



Name of the Student: P. SURENDHAR

Branch: Mech-B

Year / Sem: 2nd / 3 sem

1. Name of the Training: APTITUDE

2. Name of the Trainer: Vijayaraj

3. Students rating of Trainers :

S. No.	Date	Subject	Rating (√)			
			Excellent	Very good	Good	Average
1	4.7.2018	APTITUDE		✓		

4. Two positive points about the programme: Improve the analysing problems, to improve present of mid.

5. Suggestions for improvement: Nil

Date: 4.7.2018

P. duf
Signature



Name of the Student: M. Naveen

Branch: Mech-B

Year / Sem: 2nd / 3 sem

4. Name of the Training: APTITUDE

5. Name of the Trainer: Vijayarajan

6. Students rating of Trainers :

S. No.	Date	Subject	Rating (√)			
			Excellent	Very good	Good	Average
1	4.7.2018	APTITUDE			✓	

4. Two positive points about the programme: Improve the maths sum

5. Suggestions for improvement: Nil

Date: 4.7.16

PRINCIPAL,
K. S. R. INSTITUTE FOR
ENGINEERING AND TECHNOLOGY,
K. S. R. KALVI NAGAR,
TIRUCHENGODE-637 215,
NAMAKKAL Dt, TAMIL NADU.

M. R. J.
Signature



Name of the Student: S. TEJASWINI Branch: ECE

Year / Sem: IInd - IIIrd

1. Name of the Training: BASIC COMMUNICATION SKILL

2. Name of the Trainer: MUKUNTHRAJAN

3. Students rating of Trainers: 10

S. No.	Date	Subject	Rating (✓)			
			Excellent	Very good	Good	Average
1	2.08.18	ENGLISH		✓		

4. Two positive points about the programme:

It was very interactive and entertaining.
And it helped us to overcome the obstacles of stage fear.

5. Suggestions for improvement:

Activities for the student should be increased.

Date: 02.08.18

S. Tejaswini
Signature



Name of the Student: K. Thangam Kumar Branch: ECE

Year / Sem: II - III

4. Name of the Training: BASIC COMMUNICATION SKILL

5. Name of the Trainer: MUKUNTHRAJAN

6. Students rating of Trainers: 10

S. No.	Date	Subject	Rating (✓)			
			Excellent	Very good	Good	Average
1	2.08.18	English		✓		

4. Two positive points about the programme:

It was very interactive and entertaining and it helped us to overcome the obstacles of stage fear.

5. Suggestions for improvement:

Activities for the student should be increased.

Date:

2/8/18

Signature

PRINCIPAL,
K. S. R. INSTITUTE FOR
ENGINEERING AND TECHNOLOGY,
K. S. R. KALVI NAGAR,
TIRUCHENGODE-637 215,
NAMAKKAL Dt, TAMIL NADU.

K. Thangam

Name of the Student: PARKAVI. S Branch: ECEYear / Sem: II / III1. Name of the Training: COMMUNICATION SKILLS2. Name of the Trainer: DR. C. MUGUNDHARAJAN3. Students rating of Trainers: 10

S. No.	Date	Subject	Rating (✓)			
			Excellent	Very good	Good	Average
1	2.8.18	ENGLISH		✓		

4. Two positive points about the programme: 1. We enjoyed a lot during this program. 2. We improved something better than before.

5. Suggestions for improvement:

We need more activity.Date: 3.8.18Signature: [Signature]Name of the Student: Priyanka. V Branch: ECEYear / Sem: II / III4. Name of the Training: Communication Skills5. Name of the Trainer: Dr. C. Mugundharajan6. Students rating of Trainers: 9

S. No.	Date	Subject	Rating (✓)			
			Excellent	Very good	Good	Average
1	2.8.2018	English	✓			

4. Two positive points about the programme: We learn about language and how to improve our soft skills.

5. Suggestions for improvement: ✓

Date: 2.8.2018

PRINCIPAL,
K. S. R. INSTITUTE FOR
ENGINEERING AND TECHNOLOGY,
K. S. R. KALVI NAGAR,
TIRUCHENGODE-637 215,
NAMAKKAL Dt, TAMIL NADU.

Signature: [Signature]



Training Schedule [2018 - 2019] Odd Semester

Ref: KSRIET/T&P/CIR/2018-19

Date: 22.05.2018

This is to inform all the HoD's, Faculties & Department Training and Placement coordinators that the Internal Training for II year, III year & IV year PRP students on various topics for the academic year 2018 - 2019 (Odd Sem) has been scheduled. All the registered students should attend the Training Programme without fail. If any student skips this Training Programme without proper permission from the respective HoDs, he / she will not be permitted for any further Training Programme and campus recruitment process. Proper Dress Code is mandatory.

Encl.,

Detailed Training Schedule - Year Wise



T&P OFFICER

T&P COORDINATOR



PRINCIPAL

Copy to:

1. All HoDs
2. Notice Board

PRINCIPAL
K. S. R. INSTITUTE FOR
ENGINEERING AND TECHNOLOGY,
K. S. R. KALVI NAGAR,
TIRUCHENGODE-637 215,
NAMAKKAL DT, TAMIL NADU.

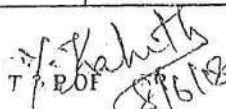
Branch	Day 1		Day 2		Day 3		Day 4		Day 5		Day 6	
	Date	Topics	Date	Topics	Date	Topics	Date	Topics	Date	Topics	Date	Topics
ECE A	12.06.18	Industry Readiness Programme	20.06.18	Programing Skills in JAVA	21.06.18	Programming Skills in JAVA	22.06.18	Programming Skills in JAVA	23.07.18	Advance Communication Skills	24.07.18	Advance Communication Skills
Faculty Name	Dr.R.Nandakumar HoD / ECE		R Venkatesan AP/CSE		R Venkatesan AP/CSE		R Venkatesan AP/CSE		Dr.C.Muhuntarajan HoD / English		Dr.C.Muhuntarajan HoD / English	
Venue	EEE Seminar Hall		FN:Hall No - 208 FN & AN: VLSI Lab		FN:Hall No - 208 FN & AN: VLSI Lab		FN:Hall No - 208 FN & AN: VLSI Lab		ECE Seminar hall		ECE Seminar hall	
ECE B	14.06.18	Industry Readiness Programme	20.06.18	Programing Skills in JAVA	21.06.18	Programming Skills in JAVA	22.06.18	Programming Skills in JAVA	26.07.18	Advance Communication Skills	27.07.18	Advance Communication Skills
Faculty Name	Dr.R.Nandakumar HoD / ECE		R Gobal AP/CSE		R Gobal AP/CSE		R Gobal AP/CSE		Dr.C.Muhuntarajan HoD / English		Dr.C.Muhuntarajan HoD / English	
Venue	EEE Seminar Hall		FN:Hall No - 211 FN & AN: DSP Lab		FN:Hall No - 211 FN & AN: DSP Lab		FN:Hall No - 211 FN & AN: DSP Lab		ECE Seminar hall		ECE Seminar hall	
MECH A	26.06.18	Industry Readiness Programme	30.07.18	Advance Communication Skills	31.07.18	Advance Communication Skills	 PRINCIPAL, K. S. R. INSTITUTE FOR ENGINEERING AND TECHNOLOGY, K. S. R. KALVI NAGAR, TIRUCHENGODE 637 215, NAMAKKAL DI, TAMIL NADU.					
Faculty Name	Dr.R.Nandakumar HoD / ECE		Dr.C.Muhuntarajan HoD / English		Dr.C.Muhuntarajan HoD / English							
Venue	EEE Seminar Hall		EEE Seminar Hall		EEE Seminar Hall							
MECH B	28.06.18	Industry Readiness Programme	06.08.18	Advance Communication Skills	07.08.18	Advance Communication Skills	 T & P COORDINATOR					
Faculty Name	Dr.R.Nandakumar HoD / ECE		Dr.C.Muhuntarajan HoD / English		Dr.C.Muhuntarajan HoD / English							
Venue	EEE Seminar Hall		EEE Seminar Hall		EEE Seminar Hall							

T & P COORDINATOR

 8/9/18

T & P COORDINATOR



 PRINCIPAL

K S R INSTITUTE FOR ENGINEERING AND TECHNOLOGY, TIRUCHENGODE - 637215

Training and placement Cell

III Year Training Schedule with Venue Details [Odd Semester]

Batch: 2016- 2020

Academic Year:2018- 2019

Branch	Day 1		Day 2		Day 3		Day 4		Day 5		Day 6	
	Date	Topics	Date	Topics	Date	Topics	Date	Topics	Date	Topics	Date	Topics
CSE	21.06.18	Industry Readiness Programme	25.06.18	Programming Skills in JAVA	26.06.18	Programming Skills in JAVA	27.06.18	Programming Skills in JAVA	05.07.18	Advance Communication Skills	06.07.18	Advance Communication Skills
Faculty Name	Dr.R.Nandakumar HoD / ECE		D Kavinya AP/CSE		D Kavinya AP/CSE		D Kavinya AP/CSE		Dr.C.Muhuntarajan HoD / English		Dr.C.Muhuntarajan HoD / English	
Venue	ECE Seminar Hall		FN:Hall No - 102 FN & AN: CSE Lab - II		FN:Hall No - 102 FN & AN: CSE Lab - II		FN:Hall No - 102 FN & AN: CSE Lab - II		EEE Seminar Hall		EEE Seminar Hall	
IT	19.06.18	Industry Readiness Programme	25.06.18	Programming Skills in JAVA	26.06.18	Programming Skills in JAVA	27.06.18	Programming Skills in JAVA	09.07.18	Advance Communication Skills	10.07.18	Advance Communication Skills
Faculty Name	Dr.R.Nandakumar HoD / ECE		L Deepan Prabu AP/IT		L Deepan Prabu AP/IT		L Deepan Prabu AP/IT		Dr.C.Muhuntarajan HoD / English		Dr.C.Muhuntarajan HoD / English	
Venue	ECE Seminar Hall		FN:Hall No - 104 FN & AN: IT Lab - II		FN:Hall No - 104 FN & AN: IT Lab - II		FN:Hall No - 104 FN & AN: IT Lab - II		ECE Seminar hall		ECE Seminar hall	
EEE	20.06.18	Programming Skills in JAVA	21.06.18	Programming Skills in JAVA	22.06.18	Programming Skills in JAVA	30.06.18	Industry Readiness Programme	12.07.18	Advance Communication Skills	13.07.18	Advance Communication Skills
Faculty Name	L Deepan Prabu AP/IT		L Deepan Prabu AP/IT		L Deepan Prabu AP/IT		Dr.R.Nandakumar HoD / ECE		Dr.C.Muhuntarajan HoD / English		Dr.C.Muhuntarajan HoD / English	
Venue	FN:Hall No - 106 FN & AN: CSE Lab - I		FN:Hall No - 106 FN & AN: CSE Lab - I		FN:Hall No - 106 FN & AN: CSE Lab - I		EEE Seminar Hall		ECE Seminar hall		ECE Seminar hall	

PRINCIPAL,
 K. S. R. INSTITUTE FOR
 ENGINEERING AND TECHNOLOGY,
 K. S. R. KALVI NAGAR,
 TIRUCHENGODE-637 215,
 NAMAKKAL Dt, TAMIL NADU.

Training and Placement Cell

ECE A - Internal Industry Readiness Training Programme, Programming Skills In Java & Advance Communication Skills Training Attendance

BATCH : 2016 - 2020

Academic Year: 2018 - 2019

Training Topics		Industry Readiness Training Programme				Advance Communication Skills			
Name of the Trainer		Dr.R.Nandakumar HoD / ECE				Dr.C.Muhuntarajan HoD/Eng			
Date of Training Programme		12.06.18		23.07.18		24.07.18			
S. No	Name	FN	AN	FN	AN	FN	AN		
1	731616106001	ABDULKADHAR S	/	/	/	/	/	/	
2	731616106002	ABISHEK T	a	a	/	/	/	/	
3	731616106003	ADHITHYA KUMAR M	/	/	/	/	/	/	
4	731616106004	AJEETH KUMAR M	a	a	/	/	/	/	
5	731616106005	AKSHAYA N M	/	/	/	/	/	/	
6	731616106006	ANANTH N	/	/	/	/	/	/	
7	731616106007	ANANTHA KRISHNAN P	/	/	/	/	/	/	
8	731616106008	ARULIEESWARAN R	/	/	a	a	/	/	
9	731616106009	ASWIN S	/	/	/	/	/	/	
10	731616106010	BALAJI R	/	/	/	/	/	/	
11	731616106011	BHAVYA D	/	/	/	/	/	/	
12	731616106012	BHAVYASHREE S	/	/	/	/	/	/	
13	731616106013	BHUVANESHWARI P	a	a	/	/	/	/	
14	731616106014	BRAHADEESHWARAN M	a	a	/	/	/	/	
15	731616106015	BRINDHA M	/	/	/	/	/	/	
16	731616106016	DANATHARSHINI G	/	/	/	/	/	/	
17	731616106017	DHARANI V	/	/	/	/	/	/	
18	731616106018	DHIVYA T	/	/	/	/	/	/	
19	731616106019	DINESH KRISHNA S	a	a	/	/	/	/	
20	731616106020	DIVYA T	/	/	/	/	/	/	
21	731616106021	DURAIRAJ S	/	/	/	/	/	/	
22	731616106022	ELANGO VAN V	/	/	/	/	/	/	
23	731616106023	GOKULAKRISHNAN A	/	/	/	/	/	/	
24	731616106024	GOWTHAM M	/	/	/	/	/	/	
25	731616106026	ILAKIYA S	/	/	/	/	/	/	
26	731616106027	INDIRAKUMAR M	a	a	/	/	/	/	
27	731616106028	ISWARYA P	/	/	/	/	/	/	
28	731616106029	JAYASHRI M	/	/	/	/	/	/	
29	731616106030	KAJAPATHY V	/	/	/	/	/	/	
30	731616106031	KANIMOZHI R	/	/	/	/	/	/	
31	731616106032	KARTHIKEYAN S	/	/	/	/	/	/	
32	731616106033	KARTHIKEYAN V	/	/	/	/	/	/	

PRINCIPAL
K. S. R. INSTITUTE FOR
ENGINEERING AND TECHNOLOGY,
K. S. R. KALMI NAGAR,
TIRUCHENGODE-637 215,
NAMAKKAL DI, TAMIL NADU.

Date of Training Programme			12.06.18		23.06.18		24.06.18	
S. No		Name	FN	AN	FN	AN	FN	AN
33	731616106034	KOKILA K	1	1	1	1	1	1
34	731616106035	LAKSHMANAN R	a	a	1	1	1	1
35	731616106036	LOGESH KUMAR K	a	a	1	1	1	1
36	731616106037	MAHESWARAN J	1	1	1	1	1	1
37	731616106038	MALATHI A S	1	1	1	1	1	1
38	731616106039	MARIMUTHU M	1	1	1	1	a	a
39	731616106040	MEENA A	1	1	1	1	1	1
40	731616106041	MEKALAI K	1	1	1	1	1	1
41	731616106042	MONIKA R	1	1	1	1	1	1
PRESENT			33	33	40	40	40	40
ABSENT			8	8	1	1	1	1
PERMISSION			-	-	-	-	-	-
OD			-	-	-	-	-	-
NI			-	-	-	-	-	-

 PRINCIPAL,
 K. S. R. INSTITUTE FOR
 ENGINEERING AND TECHNOLOGY,
 K. S. R. KALVI NAGAR,
 TIRUCHENGODE-637 215,
 NAMAKKAL DI, TAMIL NADU.

Training and Placement Cell

ECE B - Internal Industry Readiness Training Programme, Programming Skills In Java & Advance Communication Skills Training Attendance

BATCH : 2016 - 2020

Academic Year: 2018 - 2019

Training Topics		Industry Readiness Training Programme				Advance Communication Skills			
Name of the Trainer		Dr.R.Nandakumar HoD / ECE				Dr.C.Muhuntarajan HoD/Eng			
Date of Training Programme			14.06.18.		15.06.18 26.07.18		14.06.18 27.07.18		
S. No	Reg no	Name	FN	AN	FN	AN	FN	AN	
1	731616106043	MUGILAN M	/	/	a	a	/	/	
2	731616106044	NANDHAKUMAR M	/	/	/	/	/	/	
3	731616106045	NANDHAKUMAR P	/	/	/	/	/	/	
4	731616106046	NANDHAKUMARAN R	/	/	/	/	/	/	
5	731616106047	NARESHKUMAR S	/	/	a	a	/	/	
6	731616106048	NAVEEN K	/	/	/	/	/	/	
7	731616106049	NIVETHA S	/	/	/	/	/	/	
8	731616106050	NIVETHA T	/	/	/	/	a	a	
9	731616106051	POORNIMA N	/	/	/	/	/	/	
10	731616106052	PRAVEENA M	/	/	/	/	/	/	
11	731616106053	PRIYADHARSHINI M	/	/	/	/	/	/	
12	731616106054	PRIYADHARSHINI S	/	/	/	/	/	/	
13	731616106055	PRIYADHARSHNI P	/	/	/	/	/	/	
14	731616106056	PRIYANKA C	a	a	/	/	/	/	
15	731616106057	PRIYANKA S S	/	/	/	/	/	/	
16	731616106058	RAMYA SRI E	/	/	/	/	/	/	
17	731616106059	RANJITH V	/	/	a	a	/	/	
18	731616106060	ROSHINI T	/	/	/	/	/	/	
19	731616106061	SAKTHI PRIYA S	/	/	/	/	/	/	
20	731616106062	SANTHIA G	/	/	/	/	/	/	
21	731616106063	SANTHOSHKUMAR J	/	/	/	/	/	/	
22	731616106064	SATHYAMOORTHY K	/	/	/	/	/	/	
23	731616106065	SELLAKRISHNARAJA S	/	/	/	/	/	/	
24	731616106066	SHARVESH RAM K R	/	/	/	/	/	/	
25	731616106067	SHOWMIYA M	/	/	a	a	/	/	
26	731616106068	SHYAM SUNDAR R	/	/	/	/	/	/	
27	731616106069	SRIMATHI G	/	/	/	/	/	/	
28	731616106070	SUBASH V	a	a	/	/	/	/	
29	731616106071	SUBASHINI R	/	/	/	/	/	/	
30	731616106072	SUMATHI R	/	/	/	/	/	/	
31	731616106073	SURIYA E	/	/	/	/	/	/	
32	731616106074	SURYA R	/	/	/	/	/	/	

PRINCIPAL,
K. S. R. INSTITUTE FOR
ENGINEERING AND TECHNOLOGY,
K. S. R. KALVI NAGAR,
TIRUCHENGODE-637 215,
NAMAKKAL DI, TAMIL NADU.

Date of Training Programme			14.06.18		26.07.18		27.07.18	
S. No	Reg no	Name	FN	AN	FN	AN	FN	AN
33	731616106075	SYED SALMAN N	/	/	/	/	/	/
34	731616106076	TAMILARASI S	/	/	/	/	/	/
35	731616106077	THAMARA KANNAN A S	/	/	/	/	/	/
36	731616106078	THANGARAJ J	/	/	/	/	/	/
37	731616106079	THANGAVEL P	/	/	/	/	/	/
38	731616106080	THARANYA P	/	/	/	/	/	/
39	731616106081	VIGNESH P	/	/	/	/	/	/
40	731616106082	VIGNESH R	/	/	/	/	/	/
41	731616106083	VIMAL KUMAR R	/	/	/	/	a	a
42	731616106084	YOGESH S	/	/	/	/	/	/
43		NAVA NANDHINI	/	/	a	a	a	a
PRESENT			41	41	38	38	40	40
ABSENT			2	2	5	5	3	3
PERMISSION			-	-	-	-	-	-
OD			-	-	-	-	-	-
NI			-	-	-	-	-	-

PRINCIPAL
K. S. R. INSTITUTE FOR
ENGINEERING AND TECHNOLOGY,
K. S. R. KALVI NAGAR,
TIRUCHENGODE-637 215,
NAMAKKAL DI, TAMIL NADU.

IT - Internal Industry Readiness Training Programme, Programming Skills In Java & Advance Communication Skills Training Attendance

BATCH : 2016 - 2020

Academic Year: 2018 - 2019

Training Topics		Industry Readiness Training Programme	Advance Communication Skills					
Name of the Trainer		Dr.R.Nandakumar HoD / ECE	Dr.C.Muhuntarajan HoD/Eng					
Date of Training Programme			19.06.18		09.07.18		10.07.18	
S. No	Reg No	Name	FN	AN	FN	AN	FN	AN
1	731616205001	AHAMED FAISHAL H	/	/	/	/	/	/
2	731616205002	AJITH KUMAR M	/	/	/	/	/	/
3	731616205003	ARAVINDH K	/	a	/	/	/	/
4	731616205004	ARUN KUMAR A	/	/	/	/	/	/
5	731616205006	BOOPALAN G	/	/	/	/	/	/
6	731616205007	DEEPAN K	/	/	/	/	/	/
7	731616205008	GOPI S	/	/	a	a	L	L
8	731616205009	GOWRI D	/	/	/	/	/	/
9	731616205010	GOWTHAM D	a	/	a	a	/	/
10	731616205011	HAKKEM M	/	/	/	/	/	/
11	731616205012	INDHUMATHI S	/	/	/	/	/	/
12	731616205013	IYYAPPAN J	/	/	/	/	/	/
13	731616205014	JANANI M	/	/	/	/	/	/
14	731616205015	JANANI R	/	/	/	/	/	/
15	731616205016	JANANI T	/	/	/	/	/	/
16	731616205017	KARKULAZHI S	/	/	/	/	/	/
17	731616205018	KARTHIKA M	/	/	/	/	/	/
18	731616205019	KAUSALYA J	/	/	/	/	/	/
19	731616205020	KIRUBAKARAN R	/	/	/	/	/	/
20	731616205021	MANI BHARATHI G	/	/	/	/	/	/
21	731616205022	MOHANKUMAR M	/	/	/	/	/	/
22	731616205023	MOHANRAJ S	/	/	/	/	/	/
23	731616205024	MOUNIKA S	/	/	/	/	/	/
24	731616205025	NESHAK KUMAR S	a	/	/	/	/	/
25	731616205026	OVIYA A	/	/	L	L	L	L
26	731616205027	PRATHAP KUMAR E	/	/	/	/	/	/
27	731616205028	PRIYADARSHNI G	/	/	/	/	/	/
28	731616205029	SAKTHIRAVIKUMAR M	/	/	/	/	/	/
29	731616205030	SAM MCKENZIE R	/	a	/	/	/	/
30	731616205031	SARASWATHY K	/	/	/	/	/	/
31	731616205032	SATHAMHUSSAIN M S	/	/	/	/	/	/
32	731616205033	SATHAS R	/	/	/	/	/	/

PRINCIPAL
K. S. R. INSTITUTE FOR
ENGINEERING AND TECHNOLOGY,
K. S. R. KALVI NAGAR,
TIRUCHENGODE-637 215,
NAMAKKAL Dt, TAMIL NADU.

Date of Trainng Programme			19.06.18		09.07.18		10.07.18	
S. No	Reg No	Name	FN	AN	FN	AN	FN	AN
33	731616205034	STEEPEN V	1	1	L	L	1	1
34	731616205035	STEPHENRAJ J	1	1	1	1	1	1
35	731616205036	SUDARSAN S	1	a	1	1	1	1
36	731616205037	SUGITHA S	1	1	1	1	1	1
37	731616205038	SUMITHA J	1	1	1	1	1	1
38	731616205039	SWETHA S	1	1	1	1	1	1
39	731616205040	TAMILARASAN G	1	1	1	1	1	1
40	731616205041	VIGNESH M	1	1	1	1	1	1
41	731616205042	VIJI V	1	1	1	1	1	1
42	731616205043	VINOTH M	1	1	1	1	1	1
43	731616205044	YAKSHEETHA V	1	a	1	1	1	1
44	731616205045	YUVAPRIYA R	1	1	1	1	1	1
PRESENT			42	40	38	38	40	40
ABSENT			2	4	2	2	-	-
PERMISSION			-	-	2	2	2	2
OD			-	-	-	-	-	-
NOT INTEREST			-	-	-	-	-	-

 PRINCIPAL,
 K. S. R. INSTITUTE FOR
 ENGINEERING AND TECHNOLOGY,
 K. S. R. KALVI NAGAR,
 TIRUCHENGODE-637 215,
 NAMAKKAL DI, TAMIL NADU.

BATCH : 2016 - 2020

Academic Year: 2018 - 2019

Training Topics		Industry Readiness Training Programme				Advance Communication Skills				
Name of the Trainer		Dr.R.Nandakumar HoD / ECE				Dr.C.Muhuntarajan HoD/Eng				
Date of Trainng Programme			21.06.18		05.07.18		06.07.18			
S. No	Reg No	Name	FN	AN	FN	AN	FN	AN		
1	731616104001	AJITH KUMAR.P	/	/	/	/	/	/		
2	731616104002	AKILAN.Y	/	/	/	/	/	/		
3	731616104003	ANISHA.N	/	/	/	/	/	/		
4	731616104004	ARUN.R	/	/	/	/	/	/		
5	731616104005	BARATH.K	/	/	a	a	/	/		
6	731616104006	DEEPAK SURIYA.A	/	/	/	/	/	/		
7	731616104007	DEVADHARSHINI.S.S.	/	/	/	/	/	/		
8	731616104008	DEVI GAYATHRIS	NI							
9	731616104009	DHARANI.K	NI							
10	731616104010	GOWRIS	/	/	/	/	/	/		
11	731616104011	GOWTHAMAKUMARAN.P	/	/	/	/	a	a		
12	731616104012	HARINI.R	/	/	/	/	/	/		
13	731616104013	ILAKIYAS	/	/	/	/	/	/		
14	731616104014	INDHU.R	/	/	/	/	/	/		
15	731616104015	INDIRA PRIYADHARSHINI.P	/	/	/	/	/	/		
16	731616104016	JAYAVARSHINI.G	/	/	/	/	/	/		
17	731616104017	JEEVITHA.R	NI							
18	731616104018	KAMALESH.M	/	/	/	/	/	/		
19	731616104019	LAXMANCIBIS	/	/	/	/	/	/		
20	731616104020	MANIKANDAN.K	/	/	/	/	/	/		
21	731616104021	MANJULA.R	/	/	/	/	/	/		
22	731616104022	MEGASURIYAN.E	/	/	/	/	/	/		
23	731616104023	MOHAMMEDSAMIRA	/	/	/	/	/	/		
24	731616104024	NATHISH KUMARA	NI							
25	731616104026	PAVITHIRAN.S	/	/	/	/	/	/		
26	731616104027	PRAVEEN KUMAR.M	/	/	/	/	/	/		
27	731616104028	PREMNATH.R	/	/	/	/	/	/		
28	731616104030	PRIYANKA.V	NI							
29	731616104031	PUGAZHIVELAN.P	/	/	/	/	a	a		
30	731616104033	RAJARAJAN.A	/	/	/	/	/	/		
31	731616104034	SELVAMALINI.J	/	/	/	/	/	/		
32	731616104035	SHILPA.B	/	/	/	/	/	/		

 PRINCIPAL
 K. S. R. INSTITUTE FOR
 ENGINEERING AND TECHNOLOGY,
 K S R KALVINAGAR
 TIRUCHENGODE-637
 NAMAKKAL DE. THIRIL NALL

Date of Training Programme			21.06.18		05.07.18		06.07.18	
S. No	Reg No	Name	FN	AN	FN	AN	FN	AN
33	731616104036	SOUNDHARYA.A	/	/	/	/	/	/
34	731616104037	SRUTHI.S	/	/	/	/	/	/
35	731616104038	STELINBERCIA.S	a	a	/	/	/	/
36	731616104039	SUBHASREE.S	NI					
37	731616104040	SWETHA.B	/	/	/	/	/	/
38	731616104041	SWETHA.C	/	/	/	/	/	/
39	731616104042	VASU MITHA.R.S	/	/	/	/	/	/
40	731616104043	VELU PRABHAS	/	/	/	/	/	/
41	731616104044	VENKATESH.M	NI					
42	731616104045	VENMATHI.S	/	/	/	/	/	/
43	731616104046	VIGNESH.G	/	/	/	/	/	/
44	731616104047	VISVESWARAN.B	/	/	/	/	/	/
45	731616104048	YUVAPRIYANKA.V	/	/	/	/	/	/
46	731616104006	DEEPAK SURIYA.A	/	/	/	/	/	/
47	731616104008	DEVI GAYATHRI.S	/	/	/	/	/	/
48	731616104009	DHARANI.K	/	/	/	/	/	/
49	731616104017	JEEVITHA.R	/	/	/	/	/	/
50	731616104024	NATHISH KUMARA.A	/	/	/	/	/	/
51	731616104030	PRIYANKA.V	/	/	/	/	/	/
52	731616104039	SUBHASREE.S	/	/	/	/	/	/
53	731616104044	VENKATESH.M	/	/	/	/	a	a
54		Gayathri	a	a	/	/	/	/
PRESENT			40	40	43	43	41	41
ABSENT			2	2	1	1	3	3
PERMISSION			2	2	-	-	-	-
OD			-	-	-	-	-	-
NOT INTEREST			10	10	10	10	10	10

 PRINCIPAL
 K. S. R. INSTITUTE FOR
 ENGINEERING AND TECHNOLOGY,
 K. S. R. KALVI NAGAR,
 TIRUCHENGODE-637 215,
 NAMAKKAL Dt, TAMIL NADU.

MECH A- Internal Industry Readiness Training Programme & Advance Communication Skills Attendance

BATCH : 2016 - 2020

Academic Year: 2018 - 2019

Training Topics		Industry Readiness Training Programme				Advance Communication Skills			
Name of the Trainer		Dr.R.Nandakumar HoD / ECE				Dr.C.Muhuntarajan HoD/Eng			
Date of Training Programme			30.07.18		31.07.18		29.08.18		
S. No	Reg No	Name	FN	AN	FN	AN	FN	AN	
1	731616114001	AAKASH S							
2	731616114002	AJITH M							
3	731616114003	ANNAMALAI K	/	/	/	/	/	/	
4	731616114004	ARSHATH S	/	/	/	/	/	/	
5	731616114005	ASWINKUMAR S	a	a					
6	731616114006	BHARATH V							
7	731616114007	BOOPATHI RAJA E	/	/	/	/	/	/	
8	731616114008	BOOPATHY K M							
9	731616114009	CHANDRASEKAR K							
10	731616114010	CHELLATHURAI T							
11	731616114011	DEEPAK R	/	/	/	/	/	/	
12	731616114012	DHAYANIDHI M	/	/	/	/	/	/	
13	731616114013	DHEVENDRAN E	/	/	a	a	/	/	
14	731616114014	DHINAKARAN P							
15	731616114015	DINESH KUMAR C	/	/	/	/	/	/	
16	731616114016	GOKUL R							
17	731616114017	GOKULRAJ P	/	/	/	/	/	/	
18	731616114018	GOPINATH G	/	/	/	/	/	/	
19	731616114019	GOVINDASAMY A	/	/	/	/	/	/	
20	731616114020	GOWTHAM P							
21	731616114021	GUNASEKARAN R	/	/	/	/	P	P	
22	731616114022	HARIHARAN M	/	/	/	/	/	/	
23	731616114023	HARIHARAN S	/	/	/	/	/	/	
24	731616114024	HARI SHANKAR P	/	/	/	/	/	/	
25	731616114025	INBARASAN C	/	/	/	/	/	/	
26	731616114027	JAYAMURUGAN K S	/	/	/	/	/	/	
27	731616114028	JEEVA K	/	/	/	/	/	/	
28	731616114029	JEEVA M	/	/	/	/	/	/	
29	731616114030	JESTINRAJ K	/	/	/	/	/	/	
30	731616114031	JOSHUA Y	/	/	/	/	/	/	
31	731616114032	KALEESWARAN D	/	/	/	/	/	/	
32	731616114033	KAROLE INFANTO D	/	/	/	/	/	/	

PRINCIPAL,
K. S. R. INSTITUTE FOR
ENGINEERING AND TECHNOLOGY,
K. S. R. KALVI NAGAR,
TIRUCHENGODE-637 215,
NAMAKKAL DI, TAMIL NADU.

Date of Training Programme			30.07.18		31.07.18		29.08.18	
S. No	Reg No	Name	FN	AN	FN	AN	FN	AN
33	731616114034	KARTHIKEYAN P	/	/	/	/	/	/
34	731616114035	KAVIN P	/	/	/	/	/	/
35	731616114036	KAVINKUMAR R	NI					
36	731616114037	KEERTHIVASAN S	NI					
37	731616114038	KESAV GOUTHAM N B	/	/	/	/	/	/
38	731616114040	KIRUBAKARAN M	/	/	/	/	/	/
39	731616114041	LAKSHMI NARAYANAN R	/	/	/	/	/	/
40	731616114042	LOGESH N	/	/	/	/	/	/
41	731616114043	LOGESH S	/	/	/	/	/	/
42	731616114044	MADHANKUMAR L	/	/	/	/	/	/
43	731616114045	MAGESWARAN A	/	/	a	a	/	/
44	731616114046	MANIKANDAN V	/	/	/	/	/	/
45	731616114047	MANOJKUMAR K	/	/	/	/	/	/
46	731616114048	MOHAMMED NIHAL R	/	/	/	/	/	/
47	731616114049	MOHANAKRISHNAN D	a	a	/	/	/	/
48	731616114050	MOHAN ARJUN KUMARAVEL	/	/	/	/	/	/
49	731616114051	MOHANRAJ B	/	/	/	/	/	/
50	731616114302	BALAJI M	/	/	/	/	/	/
51	731616114303	BARATH V	NI					
52	731616114304	ETHAYAKUMAR G	NI					
53	731616114305	JEEVANANDHAM N	/	/	/	/	/	/
54	731616114306	KARTHI S	/	/	/	/	/	/
55	731616114308	PRASANTH S	/	/	/	/	/	/
PRESENT			53	53	53	53	54	54
ABSENT			2	2	2	2	-	-
PERMISSION			0	0	0	0	1	1
OD								
NI								

 PRINCIPAL
 K. S. R. INSTITUTE FOR
 ENGINEERING AND TECHNOLOGY
 K. S. R. KALVI NAGAR,
 TIRUCHENGODE-637 216,
 NAMAKKAL DISTRICT, TAMIL NADU.

BATCH : 2016 - 2020

Academic Year: 2018 - 2019

Training Topics		Industry Readiness Training Programme				Advance Communication Skills				
Name of the Trainer		Dr.R.Nandakumar HoD / ECE				Dr.C.Muhuntarajan HoD/Eng				
Date of Training Programme			24.07.18 24.07.18		12.07.18		13.07.18			
S.No	Reg No	Name	FN	AN	FN	AN	FN	AN		
1	731616105002	AJITHA P	/	/	/	/	/	/		
2	731616105003	AKILAN G	/	/	a	a	/	/		
3	731616105004	ANBALAGAN M	/	/	/	/	/	/		
4	731616105005	ARAVIND R	/	/	/	/	/	/		
5	731616105006	BHARATH S	/	/	/	/	/	/		
6	731616105007	BHARATHI KANNAN M R	/	/	/	/	/	/		
7	731616105008	BOOPATHI M	/	/	/	/	/	/		
8	731616105010	DIVYADEVI V	/	/	/	/	/	/		
9	731616105011	GANESHBABU V	/	/	/	/	a	a		
10	731616105012	INIYA DHARINI R	/	/	/	/	/	/		
11	731616105013	JANANI T	NI							
12	731616105014	JEEVA M	/	/	/	/	/	/		
13	731616105015	JEEVA R	/	/	/	/	/	/		
14	731616105016	KAMALI SOUNDARYA B	/	/	/	/	/	/		
15	731616105017	KANIMOZHI V	/	/	/	/	/	/		
16	731616105018	KARTHIKA DEVI S	/	/	/	/	/	/		
17	731616105019	KAVINKUMAR K	/	/	/	/	/	/		
18	731616105020	KAVIYA M	/	/	/	/	/	/		
19	731616105021	LATHA S	/	/	/	/	/	/		
20	731616105022	LOGESHWARAN V	/	/	/	/	/	/		
21	731616105023	MADHUMITHA J S	/	/	/	/	/	/		
22	731616105024	MANOJKUMAR V	/	/	/	/	/	/		
23	731616105025	MATHUBALAN S	/	/	a	a	a	a		
24	731616105026	MERLIN INFANTA S	/	/	/	/	/	/		
25	731616105027	MOHANRAJ S	/	/	/	/	/	/		
26	731616105028	MONISHA S	/	/	/	/	/	/		
27	731616105029	MUGESH M	a	a	/	/	/	/		
28	731616105030	MYTHILI N	/	/	/	/	/	/		
29	731616105031	NANCY ASMITHA P A	/	/	/	/	a	a		
30	731616105032	NANDHINI M	/	/	/	/	/	/		
31	731616105033	NAVANEETHAN S	/	/	/	/	/	/		
32	731616105034	NITHIYASRI R	/	/	/	/	/	/		

PRINCIPAL.
K. S. R. INSTITUTE FOR
ENGINEERING AND TECHNOLOGY,
K. S. R. KALVI NAGAR,
TIRUCHENGODE-637 215,
NAMAKKAL DI, TAMIL NADU.

Date of Training Programme			24.07.18 20.06.18		12.07.18		13.07.18	
S. No	Reg No	Name	FN	AN	FN	AN	FN	AN
33	731616105035	PIREETHI.A	1	1	1	1	1	1
34	731616105036	PRAKASH.S.P	P	P	1	1	1	1
35	731616105037	PRAVEEN.D	1	1	1	1	1	1
36	731616105038	PRAVIN.R	1	1	1	1	1	1
37	731616105039	PREETHA.E	1	1	1	1	1	1
38	731616105040	PREMKUMAR.G	1	1	1	1	1	1
39	731616105041	SARANYA.P	1	1	1	1	1	1
40	731616105042	SARAVANAN.V	1	1	1	1	1	1
41	731616105043	SHANKAR NARAYAN.M	1	1	P	P	P	P
42	731616105044	SIBIN.S	1	1	P	P	P	P
43	731616105045	SUJITHA.E	1	1	1	1	1	1
44	731616105046	SUVETHA.T	1	1	1	1	1	1
45	731616105047	VIVEK.V	1	1	1	1	1	1
46	731616105301	DINESHKUMAR. S	1	1	1	1	1	1
47	731616105302	EDISON RAJA.R	1	1	a	a	1	1
48	731616105303	EMAIYA.K	1	1	1	1	1	1
49	731616105304	HARIHARAN.R	1	1	1	1	1	1
50	731616105305	KARTHI.K	1	1	1	1	1	1
51	731616105306	RATHNAKUMAR.V	1	1	1	1	1	1
52	731616105701	GOKUL RAJ .M	1	1	1	1	a	a
PRESENT			49	49	46	46	45	45
ABSENT			1	1	3	3	4	4
PERMISSION			1	1	2	2	2	2
OD			-	-	-	-	-	-
NOT INTEREST			1	1	1	1	1	1

 PRINCIPAL
 K. S. R. INSTITUTE FOR
 ENGINEERING AND TECHNOLOGY,
 K. S. R. KALVI NAGAR,
 TIRUCHENGODE-637 215,
 PERIYAKKALDI, TAMIL NADU.

Training and Placement Cell

MECH B- Internal Industry Readiness Training Programme & Advance Communication Skills Attendance

BATCH : 2016 - 2020

Academic Year: 2018 - 2019

Training Topics		Industry Readiness Training Programme				Advance Communication Skills				
Name of the Trainer		Dr.R.Nandakumar HoD / ECE				Dr.C.Muhuntarajan HoD/Eng				
Date of Training Programme			28.06.18 31.8.2018		06.08.18		07.08.18			
S. No	Reg No	Name	FN	AN	FN	AN	FN	AN		
1	731616114052	NAMBIRAJ J	/	/	/	/	a	a		
2	731616114053	NANDHA GOBAL S	/	/	/	/	/	/		
3	731616114054	NAVINKUMAR M	/	/	/	/	/	/		
4	731616114055	PARTHASARATHY R	/	/	a	a	/	/		
5	731616114056	PRABAKARAN S	/	/	/	/	/	/		
6	731616114057	PRABHAKARAN M	/	/	/	/	/	/		
7	731616114058	PRASANTH R	/	/	/	/	/	/		
8	731616114059	PRAVEEN R (07.01.1999)	a	a	/	/	/	/		
9	731616114060	PRAVEEN R (31.03.1999)	/	/	/	/	L	L		
10	731616114061	PRAVEENKUMAR S	/	/	/	/	/	/		
11	731616114063	RAGAVENDHAR S	/	/	/	/	/	/		
12	731616114064	RAHUL C	/	/	/	/	/	/		
13	731616114065	RAJKUMAR S	/	/	/	/	L	/		
14	731616114066	RANJITH R	/	/	/	/	/	/		
15	731616114067	RANJITHKUMAR R	/	/	/	/	/	/		
16	731616114068	RANJITH KUMAR V	/	/	/	/	/	/		
17	731616114069	RAVICHANDRAN S	/	/	/	/	/	/		
18	731616114070	RIYAZ AHAMED S	/	/	/	/	/	/		
19	731616114071	RUTHRANNAN B	/	/	/	/	/	/		
20	731616114072	SABARISH R(H)	a	a	/	/	/	/		
21	731616114073	SAKTHI GNANASUNDARAM R H	/	/	/	/	/	/		
22	731616114074	SAKTHIVEL R	/	/	/	/	/	/		
23	731616114075	SANJAY KUMAR S	/	/	/	/	/	/		
24	731616114076	SANJAY KUMAR S K	/	/	/	/	/	/		
25	731616114077	SANTHOSH KUMAR B	/	/	a	a	/	/		
26	731616114078	SANTHOSH KUMAR V	/	/	/	/	/	/		
27	731616114079	SARAN K	/	/	/	/	/	/		
28	731616114080	SARANRAJ S	/	/	/	/	/	/		
29	731616114081	SATHISH G	/	/	/	/	/	/		
30	731616114082	SHAKTHI R M	NI							
31	731616114083	SOWNDHAR A	/	/	/	/	/	/		
32	731616114084	SURYA R	NI							

PRINCIPAL.
K. S. R. INSTITUTE FOR
ENGINEERING AND TECHNOLOGY,
K. S. R. KALVI NAGAR,
TIRUCHENGODE-637 215,
NAMAKKAL Dt, TAMIL NADU.

Date of Training Programme			28.06.18		06.08.18		07.08.18		
S. No	Reg No	Name	FN	AN	FN	AN	FN	AN	
33	731616114085	TAMILMUGILAN N	/	/	/	/	/	/	
34	731616114086	THAMOTHARAN J	/	/	/	/	/	/	
35	731616114087	THIRUMURUGAN V	/	/	/	/	/	/	
36	731616114088	UTHAYA KUMAR M	/	/	/	/	/	/	
37	731616114090	VASANTHAKUMAR P	/	/	/	/	L	L	
38	731616114091	VELMURUGAN T	/	/	/	/	/	/	
39	731616114092	VIGNESH B	NI						
40	731616114093	VIGNESH V	/	/	/	/	/	/	
41	731616114094	VIJAY ANAND G	/	/	/	/	/	/	
42	731616114095	VIJAYARAGAVAN P	/	/	/	/	/	/	
43	731616114096	VINOTHMANI M	/	/	/	/	/	/	
44	731616114097	VISHNU A	L	L	/	/	/	/	
45	731616114098	VIVEK P	/	/	/	/	/	/	
46	731616114099	YOGARAJ.G	/	/	/	/	/	/	
47	731616114100	YOGESH T	/	/	/	/	/	/	
48	731616114307	PRAKASH S	/	/	/	/	/	/	
49	731616114309	SANJEEVI K P	/	/	/	/	L	L	
50	731616114310	SHANMUGAMANIVEL D	/	/	/	/	/	/	
51	731616114311	SURENDHAR J	/	/	/	/	/	/	
PRESENT			49	49	46	46	48	48	
ABSENT			2	2	1	1	2	2	
PERMISSION			-	-	4	4	1	1	
OD			-	-	-	-			
NI									

 PRINCIPAL,
 K. S. R. INSTITUTE FOR
 ENGINEERING AND TECHNOLOGY,
 K. S. R. KALVI NAGAR,
 TIRUCHENGODE-637 215,
 NAMAKKAL Dt, TAMIL NADU.

Internal Industry Readiness Programme, Basic Communication & Programming In java Training
Attendance

BATCH: 2016 - 2020

ACADEMIC YEAR: 2018 - 2018 (ODD)

DATE: 12.06.2018

Fore Noon session

S.NO	BRANCH	STRENGTH	PRESENT	ABSENT	Leave	NI
1	ECE A	41	33	8	0	0
Total		41	33	8	0	0

After Noon Session

S.NO	BRANCH	STRENGTH	PRESENT	ABSENT	Leave	NI
1	ECE A	41	33	8	0	0
Total		41	33	8	0	0

BATCH: 2016 - 2020

ACADEMIC YEAR: 2018 - 2018 (ODD)

DATE: 14.06.2018

Fore Noon session

S.NO	BRANCH	STRENGTH	PRESENT	ABSENT	Leave	NI
1	ECE B	45	39	2	0	4
Total		45	39	2	0	4

After Noon Session

S.NO	BRANCH	STRENGTH	PRESENT	ABSENT	Leave	NI
1	ECE B	45	39	2	0	4
Total		45	39	2	0	4

R. J. Jeyanth
T & P OFFICER

[Signature]
T & P CO ORDINATOR

[Signature]
PRINCIPAL

PRINCIPAL,
K. S. R. INSTITUTE FOR
ENGINEERING AND TECHNOLOGY,
K. S. R. KALVI NAGAR,
TIRUCHENGODE-637 215,
NAMAKKAL DI, TAMIL NADU.

TRAINING & PLACEMENT CELL



Internal Industry Readiness Programme, Basic Communication & Programming In java Training
Attendance

BATCH: 2016 - 2020

ACADEMIC YEAR: 2018 - 2019 (ODD)

DATE: 19.06.2018

Fore Noon session

S.NO	BRANCH	STRENGTH	PRESENT	ABSENT	Leave	NI
1	IT	44	42	2	0	0
Total		44	42	2	0	0

BATCH: 2016 - 2020

ACADEMIC YEAR: 2018 - 2018 (ODD)

DATE: 20.06.2018

After Noon session

S.NO	BRANCH	STRENGTH	PRESENT	ABSENT	Leave	NI
1	IT	44	40	4	0	0
Total		44	40	4	0	0

[Signature]
T&P OFFICER

[Signature]
T&P CO ORDINATOR

[Signature]
PRINCIPAL

PRINCIPAL,
K. S. R. INSTITUTE FOR
ENGINEERING AND TECHNOLOGY,
K. S. R. KALVI NAGAR,
TIRUCHENGODE-637 215,
NAMAKKAL Dt, TAMIL NADU.

TRAINING & PLACEMENT CELL



Internal **Industry Readiness Programme**, Basic Communication & Programming In java Training
Attendance

BATCH: 2016 - 2020

ACADEMIC YEAR: 2018 - 2018 (ODD)

DATE: 21.06.2018

Fore Noon session

S.NO	BRANCH	STRENGTH	PRESENT	ABSENT	Leave	NI
1	CSE	54	40	2	2	10
Total		54	40	2	2	10

After Noon Session

S.NO	BRANCH	STRENGTH	PRESENT	ABSENT	Leave	NI
1	CSE	54	40	2	2	10
Total		54	40	2	2	10

[Signature]
T & P OFFICER

[Signature]
21/6/18
T&P CO ORDINATOR

[Signature]
PRINCIPAL

[Green Checkmark]
PRINCIPAL.
K. S. R. INSTITUTE FOR
ENGINEERING AND TECHNOLOGY,
K. S. R. KALVI NAGAR,
TIRUCHENGODE-637 215,
NAMAKKAL DI, TAMIL NADU.

Fore Noon session

S.NO	BRANCH	STRENGTH	PRESENT	ABSENT	Leave	NI
1	CSE	54	43	1	0	10
Total		54	43	1	0	10

After Noon Session

S.NO	BRANCH	STRENGTH	PRESENT	ABSENT	Leave	NI
1	CSE	54	43	1	0	10
Total		54	43	1	0	10

Fore Noon session

S.NO	BRANCH	STRENGTH	PRESENT	ABSENT	Leave	NI
1	CSE	54	41	3	0	10
Total		54	41	3	0	10

After Noon Session

S.NO	BRANCH	STRENGTH	PRESENT	ABSENT	Leave	NI
1	CSE	54	41	3	0	10
Total		54	41	3	0	10

[Signature]
T & P OFFICER

[Signature]
05/07/18
T&P CO ORDINATOR

[Signature]
PRINCIPAL

PRINCIPAL
K. S. R. INSTITUTE FOR
ENGINEERING AND TECHNOLOGY,
K. S. R. KALVI NAGAR,
TIRUCHENGODE-637 215,
NAMAKKAL DI, TAMIL NADU.

BATCH: 2016 - 2020

ACADEMIC YEAR: 2018 - 2019 (ODD)

DATE: 09.07.2018

Fore Noon session

S.NO	BRANCH	STRENGTH	PRESENT	ABSENT	Leave
1	IT	42	38	2	2
Total		42	38	2	2

After Noon Session

S.NO	BRANCH	STRENGTH	PRESENT	ABSENT	Leave
1	IT	42	38	2	2
Total		42	38	2	2

BATCH: 2016 - 2020

ACADEMIC YEAR: 2018 - 2019 (ODD)

DATE: 10.07.2018

Fore Noon session

S.NO	BRANCH	STRENGTH	PRESENT	ABSENT	Leave
1	IT	42	40	0	2
Total		42	40	0	2

After Noon Session

S.NO	BRANCH	STRENGTH	PRESENT	ABSENT	Leave
1	IT	42	40	0	2
Total		42	40	0	2

[Signature]
T & P OFFICER

[Signature]
T&P CO ORDINATOR



[Signature]
PRINCIPAL

PRINCIPAL.
K. S. R. INSTITUTE FOR
ENGINEERING AND TECHNOLOGY,
K. S. R. KALVI NAGAR,
TIRUCHENGODE-637 215,
NAMAKKAL DI, TAMIL NADU.



BATCH: 2016 - 2020

ACADEMIC YEAR: 2018 - 2019 (ODD)

DATE: 12.07.2018

Fore Noon session

S.NO	BRANCH	STRENGTH	PRESENT	ABSENT	OD	NI
1	EEE	52	46	3	2	1
Total		52	46	3	2	1

After Noon Session

S.NO	BRANCH	STRENGTH	PRESENT	ABSENT	OD	NI
1	EEE	52	46	3	2	1
Total		52	46	3	2	1

BATCH: 2016 - 2020

ACADEMIC YEAR: 2018 - 2019 (ODD)

DATE: 13.07.2018

Fore Noon session

S.NO	BRANCH	STRENGTH	PRESENT	ABSENT	OD	NI
1	EEE	52	45	4	2	1
Total		52	45	4	2	1

After Noon Session

S.NO	BRANCH	STRENGTH	PRESENT	ABSENT	OD	NI
1	EEE	52	45	4	2	1
Total		52	45	4	2	1

[Signature]
T & P OFFICER

[Signature]
T&P CO ORDINATOR

[Signature]
PRINCIPAL
K. S. R. INSTITUTE FOR
ENGINEERING AND TECHNOLOGY,
K. S. R. KALVI NAGAR,
TIRUCHENGODE-637 215,
NAMAKKAL DI, TAMIL NADU.

TRAINING & PLACEMENT CELL



Internal Industry Readiness Programme, **Basic Communication** & Programming In java
Training Attendance

BATCH: 2016 - 2020

ACADEMIC YEAR: 2018 - 2019 (ODD)

DATE: 23.07.2018

Fore Noon session

S.NO	BRANCH	STRENGTH	PRESENT	ABSENT	Leave	NI
1	ECE A	41	40	1	0	0
Total		41	40	1	0	0

After Noon Session

S.NO	BRANCH	STRENGTH	PRESENT	ABSENT	Leave	NI
1	ECE A	41	40	1	0	0
Total		41	40	1	0	0

BATCH: 2016 - 2020

ACADEMIC YEAR: 2018 - 2019 (ODD)

DATE: 24.07.2018

Fore Noon session

S.NO	BRANCH	STRENGTH	PRESENT	ABSENT	Leave	NI
1	ECE A	41	40	1	0	0
Total		41	40	1	0	0

After Noon Session

S.NO	BRANCH	STRENGTH	PRESENT	ABSENT	Leave	NI
1	ECE A	41	40	1	0	0
Total		41	40	1	0	0

[Signature]
T & P OFFICER

[Signature]
23/7/18
T&P CO ORDINATOR

[Signature]
PRINCIPAL,
K. S. R. INSTITUTE FOR
ENGINEERING AND TECHNOLOGY,
K. S. R. KALVI NAGAR,
TIRUCHENGODE-637 215,
NAMAKKAL DL, TAMIL NADU.

[Signature]
PRINCIPAL



BATCH: 2016 - 2020

ACADEMIC YEAR: 2018 - 2019 (ODD)

DATE: 30.07.2018

Fore Noon session

S.NO	BRANCH	STRENGTH	PRESENT	ABSENT	PERMISSION	NI
1	MECH A	55	40	2	0	13
Total		55	40	2	0	13

After Noon Session

S.NO	BRANCH	STRENGTH	PRESENT	ABSENT	PERMISSION	NI
1	MECH A	55	40	2	0	13
Total		55	40	2	0	13

BATCH: 2016 - 2020

ACADEMIC YEAR: 2018 - 2019 (ODD)

DATE: 31.07.2018

Fore Noon session

S.NO	BRANCH	STRENGTH	PRESENT	ABSENT	PERMISSION	NI
1	MECH A	55	41	0	1	13
Total		55	41	0	1	13

After Noon Session

S.NO	BRANCH	STRENGTH	PRESENT	ABSENT	PERMISSION	NI
1	MECH A	55	41	0	1	13
Total		55	41	0	1	13

V. Kalvi
T & P OFFICER

[Signature]
20/07/18
T&P CO ORDINATOR

[Signature]
PRINCIPAL,
K. S. R. INSTITUTE FOR
ENGINEERING AND TECHNOLOGY,
K. S. R. KALVI NAGAR,
TIRUCHENGODE-637 215,
NAMAKKAL DI, TAMIL NADU.



BATCH: 2016 - 2020

ACADEMIC YEAR: 2018 - 2019 (ODD)

DATE: 06.08.2018

Fore Noon session

S.NO	BRANCH	STRENGTH	PRESENT	ABSENT	PERMISSIO N	NI
1	MECH B	51	46	2	0	3
Total		51	46	2	0	3

After Noon Session

S.NO	BRANCH	STRENGTH	PRESENT	ABSENT	PERMISSIO N	NI
1	MECH B	51	46	2	0	3
Total		51	46	2	0	3

BATCH: 2016 - 2020

ACADEMIC YEAR: 2018 - 2019 (ODD)

DATE: 07.08.2018

Fore Noon session

S.NO	BRANCH	STRENGTH	PRESENT	ABSENT	Leave	NI
1	MECH B	51	43	1	4	3
Total		51	43	1	4	3

After Noon Session

S.NO	BRANCH	STRENGTH	PRESENT	ABSENT	Leave	NI
1	MECH B	51	43	1	4	3
Total		51	43	1	4	3

P. Lakshmi
T & P OFFICER

[Signature]
T&P CO ORDINATOR

[Signature]
PRINCIPAL

[Signature]
PRINCIPAL

K. S. R. INSTITUTE FOR
ENGINEERING AND TECHNOLOGY,
K. S. R. KALVI NAGAR,
TIRUCHENGODE-637 215,
NAMAKKAL Dt, TAMIL NADU,

BATCH: 2016 - 2020

ACADEMIC YEAR: 2018 - 2019 (ODD)

DATE: 13.08.2018

Fore Noon session

S.NO	BRANCH	STRENGTH	PRESENT	ABSENT	PERMISSION	NI
1	ECE B	42	38	4	0	0
Total		42	38	4	0	0

After Noon Session

S.NO	BRANCH	STRENGTH	PRESENT	ABSENT	PERMISSION	NI
1	ECE B	42	38	4	0	0
Total		42	38	4	0	0

BATCH: 2016 - 2020

ACADEMIC YEAR: 2018 - 2019 (ODD)

DATE: 14.08.2018

Fore Noon session

S.NO	BRANCH	STRENGTH	PRESENT	ABSENT	Leave	NI
1	ECE B	42	40	2	0	0
Total		42	40	2	0	0

After Noon Session

S.NO	BRANCH	STRENGTH	PRESENT	ABSENT	Leave	NI
1	ECE B	42	40	2	0	0
Total		42	40	2	0	0

[Signature]
T & P OFFICER
28/8

[Signature]
T&P CO ORDINATOR

[Signature]
PRINCIPAL
K. S. R. INSTITUTE FOR ENGINEERING AND TECHNOLOGY,
K. S. R. KALVI NAGAR,
TIRUCHENGODE-637 215,
NAMAKKAL Dt, TAMIL NADU.

TRAINING & PLACEMENT CELL



Internal Industry Readiness Programme, Basic Communication & Programming In java
Training Attendance

BATCH: 2016 - 2020

ACADEMIC YEAR: 2018 - 2019 (ODD)

DATE: 24.08.2018

Fore Noon session

S.NO	BRANCH	STRENGTH	PRESENT	ABSENT	OD	NI
1	EEE	52	49	1	1	1
Total		52	49	1	1	1

After Noon Session

S.NO	BRANCH	STRENGTH	PRESENT	ABSENT	OD	NI
1	EEE	52	49	1	1	1
Total		52	49	1	1	1

T & P OFFICER

T & P CO ORDINATOR

PRINCIPAL

PRINCIPAL.
K. S. R. INSTITUTE FOR
ENGINEERING AND TECHNOLOGY,
K. S. R. KALVI NAGAR,
TIRUCHENGODE-637 215,
NAMAKKAL DI, TAMIL NADU.



Fore Noon session

S.NO	BRANCH	STRENGTH	PRESENT	ABSENT	PERMISSION	NI
1	MECH A	55	40	2	0	13
Total		55	40	2	0	13

After Noon Session

S.NO	BRANCH	STRENGTH	PRESENT	ABSENT	PERMISSION	NI
1	MECH A	55	40	2	0	13
Total		55	40	2	0	13

Fore Noon session

S.NO	BRANCH	STRENGTH	PRESENT	ABSENT	Leave	NI
1	MECH B	51	45	2	1	3
Total		51	45	2	1	3

After Noon Session

S.NO	BRANCH	STRENGTH	PRESENT	ABSENT	Leave	NI
1	MECH B	51	45	2	1	3
Total		51	45	2	1	3

T & P OFFICER

T&P CO ORDINATOR

PRINCIPAL.

PRINCIPAL

K. S. R. INSTITUTE FOR
ENGINEERING AND TECHNOLOGY,
K. S. R. KALVI NAGAR,
TIRUCHENGODE-637 215,
NAMAKKAL Dt, TAMIL NADU.

**K S R INSTITUTE FOR ENGINEERING AND TECHNOLOGY
TIRUCHENGODE - 637 215**

TRAINING PROGRAMME FEEDBACK FORM



Name of the Student: S. Nivetha Branch: ECE

Year / Sem: 3rd / odd

1. Name of the Training: Industry Readiness programme

2. Name of the Trainer: Dr. R. Nandhakumar HOD / ECE

3. Students rating of Trainers: 10/10

S. No.	Date	Subject	Rating (✓)			
			Excellent	Very good	Good	Average
1	14.6.18	Industry Readiness Programme		✓		

4. Two positive points about the programme:

To Develop communication skills,
Upgrade our energy.

5. Suggestions for improvement:

Nothing.

Date: 14.6.18

S. Nivetha
Signature

**K S R INSTITUTE FOR ENGINEERING AND TECHNOLOGY
TIRUCHENGODE - 637 215**

TRAINING PROGRAMME FEEDBACK FORM



Name of the Student: R. Shyam Sundar Branch: ECE

Year / Sem: 3rd / odd

4. Name of the Training: Industry Readiness Programme

5. Name of the Trainer: Dr. R. Nandhakumar HOD / ECE

6. Students rating of Trainers: 10/10

S. No.	Date	Subject	Rating (✓)			
			Excellent	Very good	Good	Average
1	14.06.18	Industry Readiness Programme			✓	

4. Two positive points about the programme:

+ To develop communication skills
+ self confidence.

5. Suggestions for improvement:

Nothing.

Date: 14.06.18

PRINCIPAL,
K. S. R. INSTITUTE FOR
ENGINEERING AND TECHNOLOGY,
K. S. R. KALVI NAGAR,
TIRUCHENGODE-637 215
NAMAKKAL Dt, TAMIL NADU

[Signature]
Signature

REPORT ON COMMUNICATION SKILLS TRAINING

Submitted to:

The Principal,
K S R Institute for Engineering and Technology,
Tiruchengode – 637215.

Submitted through:

Dr. R. Nandakumar,
Training and Placement Coordinator,
K S R Institute for Engineering and Technology,
Tiruchengode – 637215.

Submitted by:

Dr. C. Muhuntarajan,
Associate Professor and Head,
Department of English,
K S R Institute for Engineering and Technology,
Tiruchengode – 637215.

Date: 16.08.2018

Dear Sir,

In the completion of the Placement Training Programme for II & III Year Students, I submit you the detailed Report with my findings, suggestions and next plan to proceed. The details of the Training Programme are mentioned below for your kind reference.

Topics : Basic Communication Skills (II Year)
Advanced Communication Skills (III Year)

No. of Classes : 7 (II Year)
7 (III Year)

No. of Days : 14 days (II Year) – 2 days for each class
14 days (III Year) – 2 days for each class

Dates : 14.06.2018 to 14.08.2018

Venue : ECE Seminar Hall & EEE Seminar Hall

Materials : Handbook (Photocopied)

Tools Used : PPTs, Audios & Videos

PRINCIPAL,
K. S. R. INSTITUTE FOR
ENGINEERING AND TECHNOLOGY,
K. S. R. KALVI NAGAR,
TIRUCHENGODE-637 215,
NAMAKKAL DI, TAMIL NADU.

Students were given the Basic Communication Skills and Advanced Communication Skills Training with the support of a photocopied Handbook which covered the essential contents of the training. The sessions were mixed with PPTs, Activities, Interactions, Audio & Video Clippings, etc. They were grouped with different teams and all of them had a chance to come out for participation. Some of them were motivated if they have any hesitation to speak. They were also given complete freedom to make fun, pass comments loudly and speak comfortably. On the whole, all the students enjoyed the amicable ambience.

Findings:

Positives:

- Good attendance record
- Everyone maintained discipline, punctuality and dress code
- Everyone enjoyed the freedom and the comfort
- Many students were very much interactive
- Many actively participated in all the activities
- 90% of students were very receptive
- Everyone realized the importance of the Communication Skills
- Many came out of stage fear and talked on stage

Negatives:

- Not updated with the current affairs
- Not volunteer participation
- Hesitation to mingle and discuss with new friends
- Not regular Speaking practice
- Very average in vocabulary

Suggestions:

- Students should be given continuous speaking practices
- Awareness should be created on updating the current affairs
- A perfect platform should be created to show and improve their ability

The Next Plan

As per the directions given by Dr. R. Nandakumar sir, 15 students from each class have been identified. They have to be taken out during their S2D Classes, we should create a space and healthy competition among those creamy students. Approximately 100 students from II Year and 100 students from III Year can be moulded effectively to perform well in their Campus Interviews.

 Thanking you,

Yours truly,

 16/8/18
(Dr. C. MUHUNTARAJAN)

 16/8/18
PRINCIPAL,
K. S. R. INSTITUTE FOR
ENGINEERING AND TECHNOLOGY,
K. S. R. KALVI NAGAR,
TIRUCHENGODE-637 215,
NAMAKKAL DISTRICT, TAMIL NADU.

Name of the Student: J. S. MadhumithaBranch: III - EEEYear / Sem: III / V1. Name of the Training: Communication Skills2. Name of the Trainer: MUGUNTHA RAJAN

3. Students rating of Trainers :

S. No.	Date	Subject	Rating (✓)			
			Excellent	Very good	Good	Average
1	12/07/18	Communication	✓			

4. Two positive points about the programme:

Good interaction with students

5. Suggestions for improvement:

-

Date: 12/7/18

Signature

Name of the Student: Karthika Devi SBranch: III EEEYear / Sem: III / IV4. Name of the Training: communication skills5. Name of the Trainer: Muguntharajan

6. Students rating of Trainers :

S. No.	Date	Subject	Rating (✓)			
			Excellent	Very good	Good	Average
1	12.7.18	communication	✓			

4. Two positive points about the programme:

Good

5. Suggestions for improvement:

-

Date: 12.7.18

PRINCIPAL,
K. S. R. INSTITUTE FOR
ENGINEERING AND TECHNOLOGY,
K. S. R. KALVI NAGAR,
TIRUCHENGODE-637 215,
NAMAKKAL DI, TAMIL NADU

Signature



Name of the Student: Bharathi Kannan.M.R Branch: EE E

Year / Sem: 19/18

1.Name of the Training : Communication skills

2.Name of the Trainer : MOHUNTHAN RAJ

3.Students rating of Trainers :

S. No.	Date	Subject	Rating (✓)			
			Excellent	Very good	Good	Average
1	12/7/18	Communication skills	✓			

4. Two positive points about the programme: It is useful to our communications.

5. Suggestions for improvement: Nil

Date: 12/7/18

M.R. Bharathi
Signature



Name of the Student: M. KAVIYA Branch: EE E

Year / Sem: 19/18

4.Name of the Training : Communication skills

5.Name of the Trainer : MOHUNTHARAS

6.Students rating of Trainers :

S. No.	Date	Subject	Rating (✓)			
			Excellent	Very good	Good	Average
1	12/7/18	communication skills	✓			

4. Two positive points about the programme: Interacts with every one

5. Suggestions for improvement:

Date: 12/7/18

[Signature]
PRINCIPAL,
K. S. R. INSTITUTE FOR
ENGINEERING AND TECHNOLOGY,
K. S. R. KALVI NAGAR,
TIRUCHENGODE-637 215,
NAMAKKAL DI, TAMIL NADU.

[Signature]
Signature

Handwritten notes and signatures on the right margin.

K S R INSTITUTE FOR ENGINEERING AND TECHNOLOGY
TIRUCHENGODE - 637 215
TRAINING PROGRAMME FEEDBACK FORM



Name of the Student: N. Dhayanidhi Branch: Mechanical Engineering

Year / Sem: III / V

1. Name of the Training: Advanced communication skills

2. Name of the Trainer: C. Mughanthyarajan

3. Students rating of Trainers: 5/5

S. No.	Date	Subject	Rating (✓)			
			Excellent	Very good	Good	Average
1	30-7-18	Ice breaking		✓		

4. Two positive points about the programme:

To improve the skills in communication

5. Suggestions for improvement:

Date: 30/7/18

[Signature]
Signature

K S R INSTITUTE FOR ENGINEERING AND TECHNOLOGY
TIRUCHENGODE - 637 215
TRAINING PROGRAMME FEEDBACK FORM



Name of the Student: K. Chandrasekar Branch: Mechanical Engineering

Year / Sem: III / V

4. Name of the Training: Advance communication skills

5. Name of the Trainer: C. Mughanthyarajan

6. Students rating of Trainers: 4.5/5

S. No.	Date	Subject	Rating (✓)			
			Excellent	Very good	Good	Average
1	30-07-18	Active vs passive listening		✓		

4. Two positive points about the programme:

5. Suggestions for improvement:

Date: 30/7/18

[Signature]
PRINCIPAL,
K. S. R. INSTITUTE FOR
ENGINEERING AND TECHNOLOGY,
K. S. R. KALVI NAGAR,
TIRUCHENGODE-637 215,
NAMAKKAL Dt, TAMIL NADU.
[Signature]
Signature



Name of the Student: LOGESH.S

Branch: MECHANICAL Engineering

Year / Sem: III / IV

1. Name of the Training: Placement training

2. Name of the Trainer: Muguntharajan

3. Students rating of Trainers :

S. No.	Date	Subject	Rating (✓)			
			Excellent	Very good	Good	Average
1	30.7.18	Advanced communication skills	✓			

4. Two positive points about the programme:

- * communicate with others
- * Breaks fear.

5. Suggestions for improvement:

Date: 30/7/18

S. L.
Signature



Name of the Student: KAVIN KUMAR.R

Branch: Mech

Year / Sem: VI / V

4. Name of the Training: placement training.

5. Name of the Trainer: Muguntharajan

6. Students rating of Trainers :

S. No.	Date	Subject	Rating (✓)			
			Excellent	Very good	Good	Average
1	30/7/18	Advanced communication skills	✓			

4. Two positive points about the programme:

- very useful for our communication

5. Suggestions for improvement:

Date: 30/7/18

PRINCIPAL,
K. S. R. INSTITUTE FOR
ENGINEERING AND TECHNOLOGY
K. S. R. KALVI NAGAR,
TIRUCHENGODE-637 215,
NAMAKKAL Dt, TAMIL NADU.

R. K. S.
Signature



Name of the Student: Manoj R

Branch: Mechanical

Year / Sem: III / V

1. Name of the Training: PLACEMENT TRAINING (Advanced Communication skills)

2. Name of the Trainer: Muthasigan

3. Students rating of Trainers: 4/5

S. No.	Date	Subject	Rating (✓)			
			Excellent	Very good	Good	Average
1	06/08/18	ENGLISH	✓			

4. Two positive points about the programme: * It is very useful to improve our skills. * And useful to have to act with other peoples.

5. Suggestions for improvement: To improve General knowledge and Trainers will having a good qualification.

Date: 06/08/18

Signature M. Manoj



Name of the Student: M. Vinodhmani

Branch: mechanical

Year / Sem: III / V

4. Name of the Training: PLACEMENT TRAINING (Advanced communication skills)

5. Name of the Trainer: Muthasigan

6. Students rating of Trainers: 5/5

S. No.	Date	Subject	Rating (✓)			
			Excellent	Very good	Good	Average
1	06/8/18	English	✓			

4. Two positive points about the programme: >> very useful for developing our skills.
>> how to interact with other people.

5. Suggestions for improvement:

Nothing

Date:

06/8/18

PRINCIPAL,
K. S. R. INSTITUTE FOR
ENGINEERING AND TECHNOLOGY,
K. S. R. KALVI NAGAR,
TIRUCHENGODE-637 215,
NAMAKKAL DI, TAMIL NADU.

Signature

[Signature]



Name of the Student: R.H. Senthinathan Branch: B.E. Mechanical
Year / Sem: III / V

1. Name of the Training : Muguntharajan English

2. Name of the Trainer : Muguntharajan

3. Students rating of Trainers :

S. No.	Date	Subject	Rating (√)			
			Excellent	Very good	Good	Average
1	06.08.18	English	✓			

4. Two positive points about the programme: i) good communication.
ii) listening is good is students

5. Suggestions for improvement:

Date: 06.08.18

Subm.
Signature



Name of the Student: S. Ragavendhar Branch: B.E. Mechanical
Year / Sem: III / V

4. Name of the Training : English

5. Name of the Trainer : C. Muguntharajan

6. Students rating of Trainers :

S. No.	Date	Subject	Rating (√)			
			Excellent	Very good	Good	Average
1	06-08-18	English	✓			

4. Two positive points about the programme: i) Excellent approach
ii) Useful for our personal skill

5. Suggestions for improvement:

Date: 06-08-18

S. Ramy
Signature
PRINCIPAL.
K. S. R. INSTITUTE FOR
ENGINEERING AND TECHNOLOGY,
K. S. R. KALVI NAGAR,
TIRUCHENGODE-637 215,
NAMAKKAL DI, TAMIL NADU.



Name of the Student: S. nareesh kumar Branch: ECE

Year / Sem: 3rd / IV

1. Name of the Training: Advanced Communication Skill

2. Name of the Trainer: Mugundharajan Sir

3. Students rating of Trainers: 10

S. No.	Date	Subject	Rating (✓)			
			Excellent	Very good	Good	Average
1	14.8.18	ACS	✓			

4. Two positive points about the programme: very interesting
good activities

5. Suggestions for improvement:

NO

S. nareesh
Signature

Date: 14.8.18



Name of the Student: G. Srinathi Branch: ECE

Year / Sem: 3rd / IV

4. Name of the Training: Advanced Communication Skill

5. Name of the Trainer: Mugundharajan Sir

6. Students rating of Trainers: 10

S. No.	Date	Subject	Rating (✓)			
			Excellent	Very good	Good	Average
1	14.8.18	ACS		✓		

4. Two positive points about the programme: easy to understand

5. Suggestions for improvement: No Improvement

Date: 14.8.18

G. Srinathi
Signature
PRINCIPAL,
K. S. R. INSTITUTE FOR
ENGINEERING AND TECHNOLOGY,
K. S. R. KALVI NAGAR,
TIRUCHENGODE-637 215,
NAMAKKAL DI, TAMIL NADU.

Name of the Student: J. Thampthuan Branch: MECHANICALYear / Sem: III - IV1. Name of the Training: Advanced soft skill2. Name of the Trainer: Muguntharajan

3. Students rating of Trainers :

S. No.	Date	Subject	Rating (✓)			
			Excellent	Very good	Good	Average
1	7/02/2018	English	✓			

4. Two positive points about the programme: motivation in student5. Suggestions for improvement: It is very useful.Date: 7/8/18 - FN

Signature
Name of the Student: B. SANTHOSHUMAR Branch: MECHANICALYear / Sem: III / IV4. Name of the Training: Advanced soft skill5. Name of the Trainer: Muguntharajan

6. Students rating of Trainers :

S. No.	Date	Subject	Rating (✓)			
			Excellent	Very good	Good	Average
1	7/08/2018	English	✓			

4. Two positive points about the programme: Motivating & interesting5. Suggestions for improvement: No suggestionsDate: 7/8/18 - AN

PRINCIPAL,
K. S. R. INSTITUTE FOR
ENGINEERING AND TECHNOLOGY,
K. S. R. KALVI NAGAR,
TIRUCHENGODE-637 215,
NAMAKKAL DL, TAMIL NADU.

Signature

Name of the Student: B. VigneshBranch: MECHANICALYear / Sem: III / B1. Name of the Training: Advanced soft skills2. Name of the Trainer: Muthan

3. Students rating of Trainers :

S. No.	Date	Subject	Rating (✓)			
			Excellent	Very good	Good	Average
1	7/8/2018	English	✓			

4. Two positive points about the programme: 1. Motivation for student
2. Very interesting

5. Suggestions for improvement:

Date: 7/8/18 - FN

[Signature]
Signature

K S R INSTITUTE FOR ENGINEERING AND TECHNOLOGY
TIRUCHENGODE - 637 215

TRAINING PROGRAMME FEEDBACK FORM

Name of the Student: S. K. PRAVEENBranch: MECHANICALYear / Sem: III / B4. Name of the Training: Advanced soft skills5. Name of the Trainer: MUTHAN

6. Students rating of Trainers :

S. No.	Date	Subject	Rating (✓)			
			Excellent	Very good	Good	Average
1	7/8/2018	English	✓			

4. Two positive points about the programme: 1. Motivation for student
2. Very interesting

5. Suggestions for improvement:

Date: 7/8/18 - AN

[Signature]
Signature

PRINCIPAL
K. S. R. INSTITUTE FOR
ENGINEERING AND TECHNOLOGY
K. S. R. KALVI NAGAR
TIRUCHENGODE-637 215
MANNARKKAL BH, TAMIL NADU.



Name of the Student: R. Anil Kumar Jayan Branch: ECE - A

Year / Sem: IIIrd - year 5th Sem

1. Name of the Training: Advanced Communication Skill

2. Name of the Trainer: C. Mugartharajan

3. Students rating of Trainers: 9

S. No.	Date	Subject	Rating (✓)			
			Excellent	Very good	Good	Average
1	24/07/2018	Advanced communication skill	✓			

4. Two positive points about the programme: is useful for the Place Jobs.
It is motivating the student

5. Suggestions for improvement: -

Date: 24/07/2018

J. S. Sankar
Signature



Name of the Student: Kajapathy - V Branch: ECE

Year / Sem: IIIrd/V

4. Name of the Training: Advanced communication skills

5. Name of the Trainer: C. Mugartharajan

6. Students rating of Trainers: 10

S. No.	Date	Subject	Rating (✓)			
			Excellent	Very good	Good	Average
1	24/7/18	Advanced communication skills	✓			

4. Two positive points about the programme: It is useful to improve our food quality

5. Suggestions for improvement: -

Date: 24/7/18

K. S. R.
PRINCIPAL,
K. S. R. INSTITUTE FOR
ENGINEERING AND TECHNOLOGY,
K. S. R. KALVINAGAN
TIRUCHENGODE - 637 215,
NAMAKKAL Dt. TAMIL NADU.

K. S. R.
Signature

TRAINING PROGRAMME FEEDBACK FORM

Name of the Student: S-yogesh Branch: ECF-B' 2nd year

Year / Sem: 3rd / V

1. Name of the Training: Advanced Communication skill

2. Name of the Trainer: Mugundharajan sir

3. Students rating of Trainers: 10

S. No.	Date	Subject	Rating (✓)			
			Excellent	Very good	Good	Average
1	13.8.18	ACS	✓			

4. Two positive points about the programme: easy to understand
Sir give full freedom

5. Suggestions for improvement:

nothing...

S-yogesh

Date: 13.8.18

Signature

TRAINING PROGRAMME FEEDBACK FORM

Name of the Student: Nivetha . S Branch: ECF

Year / Sem: 3rd / V

4. Name of the Training: Advanced Communication skills

5. Name of the Trainer: Dr. Mugundharajan Sir

6. Students rating of Trainers: 10

S. No.	Date	Subject	Rating (✓)			
			Excellent	Very good	Good	Average
1	13.8.18	ACS	✓			

4. Two positive points about the programme:

class was very interesting to understand.
we do more activities.

5. Suggestions for improvement:

Nothing.

Date: 13.8.18

Nivetha
Signature

PRINCIPAL,
K. S. R. INSTITUTE FOR
ENGINEERING AND TECHNOLOGY,
K. S. R. KALVI NAGAR,
TIRUCHENGODE-637 215,
NAMAKKAL DI, TAMIL NADU.

K S R INSTITUTE FOR ENGINEERING AND TECHNOLOGY
TIRUCHENGODE - 637 215



REF: KSRIET/ENG/CIR/2018-2019/007

DATE: 18.09.2018

CIRCULAR

This is to inform all the students that Lingua Club (A Lantern to Quest...) has planned to conduct Essay Writing and Slogan Writing competitions on 25 September 2018. Interested students can enroll their names with Mr. S. Madhan, Assistant Professor of English on or before 24.09.2018. The details of the competition are as follows.

Topic: Plastic - An Evil to Earth

Duration: 30 Minutes

Venue: Language Lab

Date: 25.09.2018

Time: 01:30 p.m.

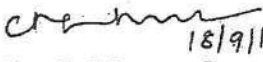
18/9/18
Dr. C. Muguntharajan
Convenor - Lingua Club

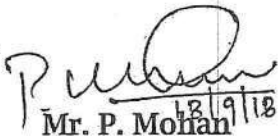
18/9/18
Mr. P. Mohan
Organiser - Lingua Club

18/9/18
PRINCIPAL

Circulated to:

- 1. HoDs - All Departments**
- 2. College Notice Board**
- 3. All I, II, III and IV Year Classes**

PRINCIPAL,
K. S. R. INSTITUTE FOR
ENGINEERING AND TECHNOLOGY,
K. S. R. KALU NAGAR,
TIRUCHENGODE - 637 215,
NAMAKKAL Dt, TAMIL NADU.

K S R INSTITUTE FOR ENGINEERING AND TECHNOLOGY

DEPARTMENT OF ENGLISH

LINGUA CLUB

ESSAY WRITING

REGISTRATION FORM

Date: 25.09.2018



S. No	Name	Class	Signature
1	AARTHI M	I CSE	Aarthi M.
2	BALAJI S	I CSE	Balaji S.
3	BHUVANSHANKAR B	I CSE	Bhuvaneshankar B.
4	CHENNAKRISHNAN S	I CSE	Chenna Krishnan S.
5	DEVA PRASATH V	I CSE	Devaprasanth V.
6	DHANUSHIYA V	I CSE	V. Dhanyasiya V.
7	GOKULAKRISHNAN B	I CSE	Gokulkrishnan B.
8	GOWSALYA G	I CSE	Gowsalya G.
9	GOWSIKAN R	I CSE	Gowikan R.
10	HARI BILGATES S	I CSE	Hari Bilgates S.
11	HEMALATHA DEVI P	I CSE	Hemalathadevi P.
12	ISHWARYA R	I CSE	Ishwarya R.
	MONISA M	I EEE	Monisha M.
13	JAILLESH K	I CSE	Jaillesh K.
14	JAYAC KEERTHATHANA S K	I CSE	Jayakarthana S K.
15	JOTHIVEL D	I CSE	Jothivel D.
16	KAMAL G	I CSE	Kamal G.
17	KAVIN M	I CSE	Kavin M.
18	KAVIYA S	I CSE	S. Kaviya S.
19	KAVIYA PRIYADHARSHINI M	I CSE	Kaviya Priya M.
20	SRIJA M	I CSE	Srija M.
21	RESHMA R	I CSE	R. Reshma R.
22	SUSHMA R	I CSE	Sushma R.
23	PRIYADHARSHINI M	I IT	Priyadharsini M.
24	SRIMATHI E	I IT	Srimathi E.
25	MOWNISHWAR C P	I IT	Mounishwar C P.
26	DHAANU S	I ECE	Dhanu S.
27	AMUTHA K	I ECE	Amutha K.
28	SRIDHAR P	I MECH	Sridhar P.
29	VIGNESH P	I MECH	Vignesh P.
30	VIJAY S	I MECH	Vijay S.
31	SAMART G	I MECH	Samrat G.
32	GOBINATH S	I MECH	Govinath S.
33	VENKATESH V	I CSE	Venkatesh V.
34	VISHNU PRASAD A	I CSE	Vishnu Prasad A.

PROSPAL
K. S. R. INSTITUTE FOR
ENGINEERING AND TECHNOLOGY,
K. S. R. KALMI NAGAR,
TIRUCHENGODE - 637 215,
N. SIVAKMAL DE, TAMIL NADU.

K S R INSTITUTE FOR ENGINEERING AND TECHNOLOGY

DEPARTMENT OF ENGLISH

LINGUA CLUB

SLOGAN WRITING

REGISTRATION FORM

Date: 25.09.2018



S. No	Name	Class	Signature
1	KAVIYA PRIYADHARSHINI M	I CSE	Kaviya Priya
2	SRIJA M	I CSE	M. Srija
3	RESHMA R	I CSE	R. Reshma
4	SUSHMA R	I CSE	R. Sushma
5	PRIYADHARSHINI M	I IT	Priyadharshini
6	SRIMATHI E	I IT	Srimathi. E
7	MOWNISHWAR C P	I IT	Mownishwar
8	DHAANU S	I ECE	Dhanu
9	AMUTHA K	I ECE	Amutha
10	SRIDHAR P	I MECH	Sridhar
11	VIGNESH P	I MECH	Vignesh
12	VIJAY S	I MECH	Vijay
13	SAMART G	I MECH	Samarath
14	GOBINATH S	I MECH	Govinath
15	VENKATESH V	I CSE	Venkatesh
16	VISHNU PRASAD A	I CSE	Vishnu Prasad
17	YOGESH K	I CSE	Yogesh
18	LOGESWARAN M	I CSE	Logeswaran
19	AARTHI M	I CSE	Aarthi M
20	BALAJI S	I CSE	Balaji
21	BHUVANSHANKAR B	I CSE	Bhuvanankar
22	CHENNAKRISHNAN S	I CSE	Chenna Krishnan
23	DEVA PRASATH V	I CSE	Devaprasath
24	DHANUSHIYA V	I CSE	V. Dhannushiya
25	GOKULAKRISHNAN B	I CSE	Gokulkrishnan
26	GOWSALYA G	I CSE	Gowsalya G
27	GOWSIKAN R	I CSE	Gowrish R
28	HARI BILGATES S	I CSE	Hari Bilgates
29	HEMALATHA DEVI P	I CSE	Hemalatha Devi P
30	ISHWARYA R	I CSE	Ishwarya R
31	MONISA M	I EEE	Monisha
32	JAILLESH K	I CSE	Jaillesh K
33	JAYAC KEERTHANA S K	I CSE	Jayacheerthana
34	JOTHIVEL D	I CSE	Jothivel D
35	KAMAL G	I CSE	Kamal G

PRINCIPAL,
K. S. R. INSTITUTE FOR
ENGINEERING AND TECHNOLOGY
R. S. R. KALYAN NAGAR,
TIRUCHENGODE - 637 215,
NAMAKKAL Dt, TAMIL NADU.

36	KAVIN M	I CSE	M. Kavina
37	KAVIYA S	I CSE	S. Kaviya
		P. M. Mohan	
			16/2/19
		(P. M. Mohan,	
		AP English)	

**K S R INSTITUTE FOR ENGINEERING AND TECHNOLOGY
TIRUCHENGODE - 637 215**



REF: KSRIET/ENG/CIR/2018-2019/016

DATE: 13.02.2019

CIRCULAR

This is to inform all the students that **Lingua Club (A Lantern to Quest...)** has planned to conduct Spell Bee and Tongue Twister competitions on 16th February 2019. Interested students can enroll their names with Mr. S. Madhan, Assistant Professor of English on or before 15.02.2019. The details of the competitions are as follows.

Topic: On the Spot

Duration: 30 Minutes for each competition

Venue: Language Lab

Date: 16.02.2019

Time: 01:30 p.m.

13/2/19.

Dr. C. Muguntharajan
Convenor - Lingua Club

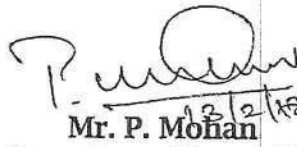
13/2/19

Mr. P. Mohan
Organiser - Lingua Club

13/2/19

PRINCIPAL

Circulated to:

- 1. HoDs - All Departments**
- 2. College Notice Board**
- 3. All I, II, III and IV Year Classes**

PRINCIPAL,
K. S. R. INSTITUTE FOR
ENGINEERING AND TECHNOLOGY,
K. S. R. KALVI NAGAR,
TIRUCHENGODE - 637 215,
NAMAKKAL Dt, TAMIL NADU.

K S R INSTITUTE FOR ENGINEERING AND TECHNOLOGY

DEPARTMENT OF ENGLISH

LINGUA CLUB

SPELL BEE

REGISTRATION FORM

Date: 16.02.2019



S. No	Name	Class	Signature
1	B. Prayadhasini	B.Tech - IT	B. Prayadhasini
2	V. Kavyadevi	B.Tech IT	V. Kavyadevi
3	Prayadhasini - M	B.Tech IT	M. Prayadhasini
4	G. Reshma	B.Tech IT	G. Reshma
5	Santhiya .K	B.Tech(IT)	K. Santhiya
6	M. Kishore	B.Tech(IT)	M. Kishore
7	B. Dharami	ECF (BE)	B. Dharami
8	K. Amutha	ECE (BE)	K. Amutha
9	S. Dhara	ECF (BE)	S. Dhara
10	R. Sushama	CSE (BE)	R. Sushama
11	R. Reshma	CSE (BE)	R. Reshma
12	M. Saija	CSE (BE)	M. Saija
13	S. Kaviya	CSE (BE)	S. Kaviya
14	C.P. Moulleshwar	B.Tech (IT)	C.P. Moulleshwar
15	N. Adhithiya Babu	B.Tech (IT)	N. Adhithiya Babu
16	J. Saonathivasan	B.E (EEE)	J. Saonathivasan
17	S. Sowmyapavan	B.E (EEE)	S. Sowmyapavan
18	N. Narayan	B.E (EEE)	N. Narayan
19	K. K. Kararadu	B.E (EEE)	K. K. Kararadu
20	V. Deva Pragasath	B.E CSE	V. Deva Pragasath
21	Sundarya .G.G	BE - CSE	Sundarya .G.G
22	P. Hemalatha, Devi	BE CSE	P. Hemalatha, Devi
23	V. Dharmalingam	BE - CSE	V. Dharmalingam
24	A. Nithyaseelin	BE - CSE	A. Nithyaseelin
25	S. Pramesh Kumar	BE - CSE	S. Pramesh Kumar
26	R. Sharmila	BE - CSE	R. Sharmila

PRINCIPAL
 K. S. R. INSTITUTE FOR
 ENGINEERING AND TECHNOLOGY,
 KANAKKAL DE, TAMIL NADU.

27	K. Jairesh	BE CSE	K. Jairesh
28	G. Gowsalya	BE CSE	G. G.
29	M. Aarthi	BE CSE	M. Aarthi
30	R. Gowrikumar	B.E. CSE	R. G. D.
31	S. Gopinath	B.E. MECH	S. Gopinath
32	P. SRIDHAR	B.E. MECH	P. S. A.
33	G. Vignesh	B.E. MECH	G. Vignesh
34	V. KARTHICK RAJA	B.E. MECH	V. Karthick Raja
35	S. VYAMA	B.E. MECH	S. V.
36	G. SAMRAT	B.E. MECH	G. Samrat
37			
38			
39			
40			(MADRAN S)
41			
42			
43			
44			PRINCIPAL, K. S. R. INSTITUTE FOR ENGINEERING AND TECHNOLOGY, K. S. R. WALATHNAGAR, TIRUCHENGODE - 637 215, NAMAKKAL DISTRICT, TAMIL NADU.
45			
46			
47			
48			
49			
50			
51			
52			
53			
54			
55			
56			
57			
58			
59			
60			

K S R INSTITUTE FOR ENGINEERING AND TECHNOLOGY

DEPARTMENT OF ENGLISH

LINGUA CLUB

TONGUE TWISTER

REGISTRATION FORM

Date: 16.02.2019



S. No	Name	Class	Signature
1	B. Priyadharsini	B.Tech-IT	B. Priyadharsini
2	V. Kavya devi	B.Tech-IT	V. Kavya devi
3	Priyadharsini	B.Tech-IT	Priyadharsini
4	G. Reshma	B.Tech-IT	G. Reshma
5	K. Ishore M	B.Tech-IT	M. Ishore
6	S. Dhaanu	B.E-ECE	S. Dhaanu
7	B. Dharami	BE-ECE	B. Dharami
8	K. Amutha	BE-ECE	K. Amutha
9	R. Sushma	BE-CSE	R. Sushma
10	R. Reshma	BE-CSE	R. Reshma
11	M. Saija	BE-CSE	M. Saija
12	S. Kaviya	BE-CSE	S. Kaviya
13	C.P. Moulleshwar	B.Tech(IT)	C.P. Moulleshwar
14	N. Adhithiya Bala	B.Tech(IT)	N. Adhithiya Bala
15	J. Sarathi Vasan	B.E(EEE)	J. Sarathi Vasan
16	S. Souriyappan	B.E(EEE)	S. Souriyappan
17	K. Jairesh	BE(CSE)	K. Jairesh
18	N. Naveen	BE(EEE)	N. Naveen
19	B. Pramesh Kumar	BE(CSE)	B. Pramesh Kumar
20	V. Deva Prassath	BE(CSE)	V. Deva Prassath
21	K. Kavyarasi	B.E(EEE)	K. Kavyarasi
22	B. Srinivasan	B.E/CSE	B. Srinivasan
23	P. G. Divya	B.E/CSE	P. G. Divya
24	A. Nithya Selvi	BE/CSE	A. Nithya Selvi
25	Sundarya. G. G	BE/CSE	Sundarya. G. G
26	Hemalatha	BE/CSE	Hemalatha

KSRIET
K. S. R. INSTITUTE FOR
ENGINEERING AND TECHNOLOGY
K. S. R. KALYANPURAM,
TIRUCHENGODE - 617 213,
NAMAKKAL DISTRICT, TAMIL NADU.

K S R INSTITUTE FOR ENGINEERING AND TECHNOLOGY
TIRUCHENGODE - 637 215



REF: KSRIET/ENG/CIR/2018-2019/018

DATE: 28.02.2019

CIRCULAR

This is to inform all the students that **Lingua Club (A Lantern to Quest...)** has planned to conduct JAM and Poem composing competitions on 02nd March 2019. Interested students can enroll their names with Mr. R. Kanagaselvam, Assistant Professor of English on or before 01.03.2019. The details of the competitions are as follows.

Topic: On the Spot

Duration: 30 Minutes for each competition

Venue: Language Lab

Date: 02.03.2019

Time: 02:00 p.m.

Mr. P. Mohan
Organiser - Lingua Club

Dr. C. Muhuntarajan
Convenor - Lingua Club

Principal

Circulated to:

- 1. HoDs - All Departments**
- 2. College Notice Board**
- 3. All I, II, III and IV Year Classes**

PRINCIPAL,
K. S. R. INSTITUTE FOR
ENGINEERING AND TECHNOLOGY,
TIRUCHENGODE - 637 215

K S R INSTITUTE FOR ENGINEERING AND TECHNOLOGY

DEPARTMENT OF ENGLISH

LINGUA CLUB

JUST A MINUTE (JAM)

REGISTRATION FORM

Date: 02.03.2019



S. No	Name	Class	Signature
1	A. Nuthureli	BE - CSE	A. Nuthureli
2	G. G. Sundaraya	BE - CSE	G. G. Sundaraya
3	V. Anandhiya	BE - CSE	V. Anandhiya
4	P. Hemalatha	R. CSE	P. Hemalatha
5	Jay Princy P	BE - ECE	Jay Princy P
6	B. Pranesh Kumar	BE - CSE	B. Pranesh Kumar
7	G. Kamal	BE - CSE	G. Kamal
8	SR. Sateer Yammarthi	B.TECH (CE)	SR. Sateer Yammarthi
9	B. Thangaraj	BE - ECE	B. Thangaraj
10	G. Rangitha	BE - ECE	G. Rangitha
11	S. Thulasi Raman	R. E - ECE	S. Thulasi Raman
12	K. S. Durah	B. TECH/IT	K. S. Durah
13	N. Anithiya Bala	B. TECH	N. Anithiya Bala
14	C. P. Manish Kumar	B. TECH/IT	C. P. Manish Kumar
15	P. Sri Vasani	B. TECH	P. Sri Vasani
16	B. Prasadhaasini	B. TECH/IT	B. Prasadhaasini
17	K. Santhiya	B. TECH/IT	K. Santhiya
18	V. Harini	B. TECH/IT	V. Harini
19	M. Kishore	B. TECH/IT	M. Kishore
20	B. Monisa	BE - EEE	B. Monisa
21	R. Sushma	BE - CSE	R. Sushma
22	R. Rashma	BE - CSE	R. Rashma
23	R. Sharmila	BE - CSE	R. Sharmila
24	Tshuanyya	BE - CSE	Tshuanyya
25	Kaviya S	BE - CSE	Kaviya S
26	Srija M	BE - CSE	Srija M
27	Karthika	BE - CSE	Karthika
28	Kaviya priyadharsini	BE - CSE	Kaviya priyadharsini
29	S. K. Jagan Koothana	BE - CSE	S. K. Jagan Koothana
30	Sundharyaa	BE - CSE	Sundharyaa
31	A. Nazeen	BE - CSE	A. Nazeen
32	M. Prasadhaasini	B. TECH IT	M. Prasadhaasini
33	E. Srinidhi	B. TECH IT	E. Srinidhi
34	M. Panyalathathi	B. TECH IT	M. Panyalathathi
35			
36			

PRINCIPAL,
K. S. R. INSTITUTE FOR
ENGINEERING AND TECHNOLOGY,
K. S. R. KALAI NAGAR,
TIRUCHENGODE - 637 215,
NAMAKKAL Dt, TAMIL NADU.

02/03/19
 Dr. V. Devashanm
 Prof / Physics

K S R INSTITUTE FOR ENGINEERING AND TECHNOLOGY

DEPARTMENT OF ENGLISH

LINGUA CLUB

POEM COMPOSING

REGISTRATION FORM

Date: 02.03.2019



S.No	Name	Class	Signature
1	Soundarya. g. g.	BE. CSE	[Signature]
2	V. Dharmalingam	BE CSE	[Signature]
3	P. Hemaktha Devi	BE CSE	[Signature]
4	A. Muthuseli	BE CSE	[Signature]
5	Jey Princy. P	B.E. ECE	[Signature]
6	K. Santhiya	B.Tech. IT	[Signature]
7	B. Priyadarshini	B.Tech. IT	[Signature]
8	V. Hafini	B-Tech-IT	[Signature]
9	R. Sushma	BE CSE	[Signature]
10	R. Reshma	BE CSE	[Signature]
11	S. Kaviya	BE CSE	[Signature]
12	B. Praneeth Kumar.	BE CSE	[Signature]
13	M. Srija	BE CSE	[Signature]
14	B. Monisa	BE. ECE	[Signature]
15	M. Kishore	B.Tech-IT	[Signature]
16	K. Thangaraj	B.E. ECE	[Signature]
17	S. Tulasi Kumar	B.E. ECE	[Signature]
18	G. Ranjith	B.E. ECE	[Signature]
19	K. S. Divya	B. TECH IT	[Signature]
20	S. Srinivasan	B.Tech. IT	[Signature]
21	C. P. Manjushree	B.Tech. IT	[Signature]
22	N. Adithiya Balu	B-TECH IT	[Signature]
23	S. R. S. R. S. R.	B-TECH IT	[Signature]
24	C. Soundarya	BE CSE	[Signature]
25	M. Kaniya Priyadarshini	B.E. CSE	[Signature]
26	R. Ishwarya	B.E. CSE	[Signature]
27	R. Sharmila	B.E. CSE	[Signature]
28	S. Kruthika	B.E. CSE	[Signature]
29	S.K. Jayar Keerthithana	B.E. CSE	[Signature]
30	Logeshwaran. E	B.E. CSE	[Signature]
31	K.S. Mallesh Kumar	BE CSE	[Signature]
32	M. Ramya Lakshmi	B.Tech IT	[Signature]
33	E. Srividya	B.Tech IT	[Signature]
34	M. Priyadarshini	B.Tech IT	[Signature]
35	S. Prakash	B.E. ECE	[Signature]
36	R. Krishna Kumar	" "	[Signature]

37. G. Kaviya " "

38. Venkatesh B.E. CSE

39. Haribillal " "

PRINCIPAL,
K. S. R. INSTITUTE FOR
ENGINEERING AND TECHNOLOGY,
M. S. RAMANUJAPUR,
TAMIL NADU - 627 015,
K. S. R. ROAD, K. S. R. ROAD.

3. LIFE SKILLS

(Yoga, physical fitness, health and hygiene)

K S R INSTITUTE FOR ENGINEERING AND TECHNOLOGY

**LIFE SKILLS (YOGA, PHYSICAL FITNESS, HEALTH AND HYGIENE)
CONSOLIDATE LIST**

Academic Year:2018-2019

S.NO.	Name of the capability enhancement program	Date of implementation (DD-MM-YYYY)	Number of students enrolled	Name of the agencies/consultants involved with contact details (if any)
1	Blood Donation Camp	14.06.2018	102	KSRIET-NSS,nssksriet@gmail.com
2	Art of Meditation	26.06.2018	105	KSRIET-NSS,nssksriet@gmail.com
3	Awareness Program on YOGA	21.06.2018	38	KSRIET-YOGA CLUB



PRINCIPAL

**PRINCIPAL,
K. S. R. INSTITUTE FOR
ENGINEERING AND TECHNOLOGY,
K. S. R. KALVI NAGAR,
TIRUCHENGODE - 637 216,
NAMAKKAL Dt, TAMIL NADU.**



KSR INSTITUTE FOR ENGINEERING AND TECHNOLOGY

TIRUCHENGODE-637 215



National Service Scheme (NSS)

REF: KSRIET/NSS/CIR/2018-2019/02

CIRCULAR

DATE: 13/06/2018

Our KSRIET NSS is organizing a “Blood Donation Camp” on June 14th, 2018 (Thursday) at our EEE Seminar hall from 10.00 AM to 02.00 PM in coordination with Lions club, Erode. We are inviting donors for donating the blood and Donors can start registering their name to Mr. A. Mohanraj, AP/Mech.

All are invited

NSS Programme officer

Principal

Copy to

- The Principal Office,
- All Department HODs,
- Common Notice Board.

PRINCIPAL,
K. S. R. INSTITUTE FOR
ENGINEERING AND TECHNOLOGY,
K. S. R. KALVI NAGAR,
TIRUCHENGODE-637 215,
NAMAKKAL Dt. TAMIL NADU.

KSR INSTITUTE FOR ENGINEERING AND TECHNOLOGY
National Service Scheme (NSS)

"Blood Donation Camp" on 14/06/2018

Name List of Volunteers

Academic Year: 2018-2019

The following students are permitted to attend the camp:

S.NO	NAME OF THE STUDENT	YEAR/DEPT
1.	ARIHARAN M	I-MECH
2.	ARIVAZHAHAN R	I-MECH
3.	ARULBHARATHI G V	I-MECH
4.	ARUN PRAKASH K A	I-MECH
5.	BOOBALAN S	I-MECH
6.	CHANDRU K	I-MECH
7.	DHANASEKAR D	I-MECH
8.	DHARANEESHWARAN N	I-MECH
9.	GOPINATH S	I-MECH
10.	GOWTHAM K	I-MECH
11.	JAYAPRAKASH S	I-MECH
12.	KARTHICK RAJA V	I-MECH
13.	KAVIN S	I-MECH
14.	KAVIN KUMAR S	I-MECH
15.	KAVIRAJ G	I-MECH
16.	KRISHNAKUMAR R	I-MECH
17.	KRISHNAN S	I-MECH
18.	MANIKANDAN P	I-MECH
19.	MANIVASAGAM M	I-MECH
20.	MONISHVARAN T	I-MECH
21.	PRASANTH S	I-MECH
22.	PRAVEEN M	I-MECH
23.	RAJASEKAR S	I-MECH
24.	RAMKUMAR S	I-MECH

PRINCIPAL,
K. S. R. INSTITUTE FOR
ENGINEERING AND TECHNOLOGY
K. S. R. KALVI NAGAR,
TIRUCHENGODE-637 215.
NAMAKKAL Dt. TAMIL NADU.

25.	SAMRAT G	I-MECH
26.	GUNASEELAN C	II-MECH
27.	HARIHARAN G	II-MECH
28.	HARIPRASATH P	II-MECH /
29.	INDIRAJITH M	II-MECH
30.	JAGATHESHWARAN N	II-MECH
31.	KARTHICK R	II-MECH
32.	KARTHIK A S	II-MECH
33.	KARTHIKEYAN S	II-MECH
34.	KARTHIKEYAN T	II-MECH
35.	KARUPPAIAH K	II-MECH
36.	KATHIRVEL M	II-MECH
37.	KAVIN M	II-MECH
38.	KAVIN M	II-MECH
39.	KAVINKUMAR C	II-MECH
40.	KAVIRAJ M	II-MECH
41.	KIRUBAKARAN K	II-MECH
42.	SURESHKUMAR A	II-MECH
43.	SURESHMOORTHY P	II-MECH
44.	SURYAMOORTHY R	II-MECH
45.	TAMILSELVAN V	II-MECH
46.	THAMIL SELVAM B	II-MECH
47.	THIRUPATHI M	II-MECH
48.	THULASI RAMAN R	II-MECH
49.	VIGNESH R	II-MECH
50.	VIGNESHWARAN S	II-MECH
51.	VIJAYAKUMAR C	II-MECH
52.	VINITH D	II-MECH
53.	VINOTH KUMAR T	II-MECH
54.	YASWANTHKARTHIK S	II-MECH
55.	YOGESH N	II-MECH
56.	ABISHEK R R	II-MECH

PURSANT
 S. R. INSTITUTE FOR
 ENGINEERING TECHNOLOGY
 S. R. RAJAPET, BAR.
 TULCHENGA 613437-215
 AMBARNAL, DIST. TAMIL NADU

57.	HARIPRASATH M	II-MECH
58.	PRIYADHARSINI M	I-IT
59.	RAJESWARI K	I-IT
60.	RAJKUMAR V	I-IT
61.	RESHMA G	I-IT
62.	SANTHIYA K	I-IT
63.	SATHIYAMOORTHY S R	I-IT
64.	SELVA GANAPATHY S	I-IT
65.	SENGOTTAIYAN G	I-IT
66.	SRIMATHI E	I-IT
67.	SRINIVASAN S	I-IT
68.	VIGNESH R	I-IT
69.	VISHNUCHAKKARAVARTHI M	I-IT
70.	KAMALI R	I-IT
71.	RAGU G	II-IT
72.	RAJARAVEENDHAR G R	II-IT
73.	SAANTHOSHBALAJI S N	II-IT
74.	SANDHIYA G	II-IT
75.	SANTHOSH KUMAR R	II-IT
76.	SARAN V	II-IT
77.	SATHISHKUMAR V	II-IT
78.	SELVAMALAR P	II-IT
79.	SHAILAA P M	II-IT
80.	SHIVANI N	II-IT
81.	SIVASANKARI R	II-IT
82.	SREEMATHI INDRA S	II-IT
83.	SRIRAM S	II-IT
84.	THANESSHWARAN Y.G.	II-IT
85.	THUSMEENA K R	II-IT
86.	MEIYARASU K	I-EEE

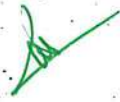
 PRINCIPAL,
 K. S. R. INSTITUTE FOR
 ENGINEERING AND TECHNOLOGY,
 K. S. R. P. O. ROAD,
 THIRUCHENGAI - 621015,
 NAMAKKAL DISTRICT, TAMIL NADU.

87.	MONISA B	I-EEE
88.	MYTHEYAN J	I-EEE
89.	NANDAKUMAR J	I-EEE
90.	NAVEEN N	I-EEE
91.	SANKAR S	I-EEE
92.	SARATHI VASAN J	I-EEE
93.	SAVURIYAPPAN S	I-EEE
94.	SRIDHAR D	I-EEE
95.	VIJAY E	I-EEE
96.	ATHIF L	I-EEE
97.	TAMILARASAN K	I-EEE
98.	TAMILSELVAN A	I-EEE
99.	PRASATH S	I-EEE
100.	DHATCHANAMOORTHY A	I-EEE
101.	GOKUL P	I-EEE
102.	GOKULRAJ P	I-EEE

NSS PROGRAMME OFFICER

PRINCIPAL,
K. S. R. INSTITUTE FOR
ENGINEERING AND TECHNOLOGY,
K. S. R. KALVI NAGAR,
TIRUCHENGODE-637 215,
NAMAKKAL DL, TAMIL NADU.

PRINCIPAL

K S R INSTITUTE FOR ENGINEERING AND TECHNOLOGY

TIRUCHENGODE – 637 215

NATIONAL SERVICE SCHEME (NSS)

Blood Donation Camp– Report

Academic Year: 2018-19

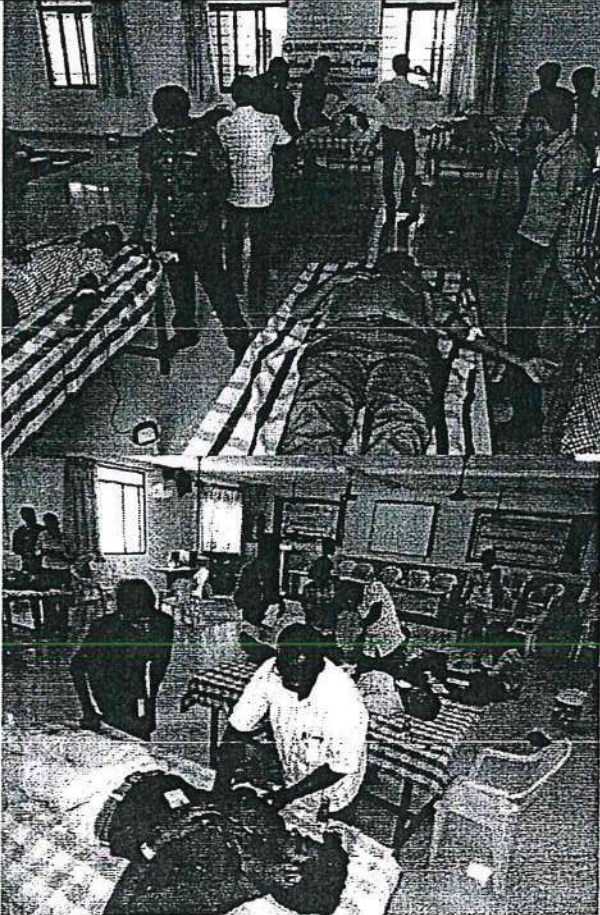
Name of the Programme	Blood Donation Camp		
Date & Time	14/06/2018 & 10:00 AM	Venue	EEE Seminar Hall
Chief Guest/Resource Person	Dr.M.Venkatesan, Principal, KSRIET Dr.R.Nandhakumar HOD/ECE, KSRIET	No of NSS Volunteers involved in the activity	26
		No of Beneficiaries	102
About Programme /Activity	<p>Our KSRIET NSS jointly organized with Lions club, the blood donation camp was organized on 14 June 2018 in our EEE Seminar hall. Our Principal Dr.M.Venkatesan, Dr.R.Nandhakumar HOD/ECE Inaugurated and provide certificates to the donors. In this programme 26 NSS Volunteers are utilized to arrange the programme and 102 students get benefited</p>		
			

Blood Donation Camp

 NSS Coordinator

 PRINCIPAL,
 K. S. R. INSTITUTE FOR
 ENGINEERING AND TECHNOLOGY,
 K. S. R. KALMAYAR,
 TIRUCHENGODE-637 215,
 NAMAKKAL DISTRICT, TAMIL NADU.

 Principal



KSR INSTITUTE FOR ENGINEERING AND TECHNOLOGY

TIRUCHENGODE

National Service Scheme (NSS)



REF: KSRIET/NSS/CIR/2018-2019/15

CIRCULAR

DATE: 18/06/2018

All the B.E/B.Tech students are hereby informed that a program on “Art of Meditation” will be organized on 26 June, 2018. Students who are interested to participate have to assemble in our Mechanical Seminar hall

Timing: 9.30AM to 11.00AM

NSS Programme officer

Principal

Copy to

- The Principal Office,
- All Department HODs,
- Common Notice Board.

PRINCIPAL,
K. S. R. INSTITUTE FOR
ENGINEERING AND TECHNOLOGY,
K. B. R. KALVI NAGAR,
TIRUCHENGODE-637 215,
NAMAKKAL DI. TAMIL NADU.

KSR INSTITUTE FOR ENGINEERING AND TECHNOLOGY

National Service Scheme (NSS)

"Art of Meditation" on 26/06/2018

Name List of Volunteers

Academic Year: 2018-2019

The following students are permitted to attend the program:

S.NO	NAME OF THE STUDENT	YEAR/DEPT
1.	ARIHARAN M	I-MECH
2.	ARIVAZHAHAN R	I-MECH
3.	ARULBHARATHI G V	I-MECH
4.	ARUN PRAKASH K A	I-MECH
5.	BOOBALAN S	I-MECH
6.	CHANDRU K	I-MECH
7.	DHANASEKAR D	I-MECH
8.	DHARANEESHWARAN N	I-MECH
9.	GOPINATH S	I-MECH
10.	GOWTHAM K	I-MECH
11.	JAYAPRAKASH S	I-MECH
12.	KARTHICK RAJA V	I-MECH
13.	KAVIN S	I-MECH
14.	KAVIN KUMAR S	I-MECH
15.	KAVIRAJ G	I-MECH
16.	KRISHNAKUMAR R	I-MECH
17.	KRISHNAN S	I-MECH
18.	MANIKANDAN P	I-MECH
19.	MANIVASAGAM M	I-MECH
20.	MONISHVARAN T	I-MECH
21.	PRASANTH S	I-MECH
22.	PRAVEEN M	I-MECH
23.	RAJASEKAR S	I-MECH
24.	RAMKUMAR S	I-MECH
25.	SAMRAT G	I-MECH

✓
PRINCIPAL,
K. S. R. INSTITUTE FOR
ENGINEERING AND TECHNOLOGY,
K. S. R. KALVI NAGAR,
TIRUCHENGODE-637 215,
NAMAKKAL DI, TAMIL NADU.

26.	GUNASEELAN C	II-MECH
27.	HARIHARAN G	II-MECH
28.	HARIPRASATH P	II-MECH
29.	INDIRAJITH M	II-MECH
30.	JAGATHESHWARAN N	II-MECH
31.	KARTHICK R	II-MECH
32.	KARTHIK A S	II-MECH
33.	KARTHIKEYAN S	II-MECH
34.	KARTHIKEYAN T	II-MECH
35.	KARUPPAIAH K	II-MECH
36.	KATHIRVEL M	II-MECH
37.	KAVIN M	II-MECH
38.	KAVIN M	II-MECH
39.	KAVINKUMAR C	II-MECH
40.	KAVIRAJ M	II-MECH
41.	KIRUBAKARAN K	II-MECH
42.	SURESHKUMAR A	II-MECH
43.	SURESHMOORTHY P	II-MECH
44.	SURYAMOORTHY R	II-MECH
45.	TAMILSELVAN V	II-MECH
46.	THAMIL SELVAM B	II-MECH
47.	THIRUPATHI M	II-MECH
48.	THULASI RAMAN R	II-MECH
49.	VIGNESH R	II-MECH
50.	VIGNESHWARAN S	II-MECH
51.	VIJAYAKUMAR C	II-MECH
52.	VINITH D	II-MECH
53.	VINOTH KUMAR T	II-MECH
54.	YASWANTHKARTHIK S	II-MECH
55.	YOGESH N	II-MECH
56.	ABISHEK R R	II-MECH
57.	HARIPRASATH M	II-MECH

✓

PRINCIPAL
K. B. K. INSTITUTE FOR
ENGINEERING AND TECHNOLOGY
S. R. KALVI NAGAR
K. B. K. INSTITUTE FOR
ENGINEERING AND TECHNOLOGY

58.	PRIYADHARSINI M	I-IT
59.	RAJESWARI K	I-IT
60.	RAJKUMAR V	I-IT
61.	RESHMA G	I-IT
62.	SANTHIYA K	I-IT
63.	SATHIYAMOORTHY S R	I-IT
64.	SELVA GANAPATHY S	I-IT
65.	SENGOTTAIYAN G	I-IT
66.	SRIMATHI E	I-IT
67.	SRINIVASAN S	I-IT
68.	VIGNESH R	I-IT
69.	VISHNUCHAKKARAVARTHI M	I-IT
70.	KAMALI R	I-IT
71.	RAGU G	II-IT
72.	RAJARAVEENDHAR G R	II-IT
73.	SAANTHOSHBALAJI S N	II-IT
74.	SANDHIYA G	II-IT
75.	SANTHOSH KUMAR R	II-IT
76.	SARAN V	II-IT
77.	SATHISHKUMAR V	II-IT
78.	SELVAMALAR P	II-IT
79.	SHAILAA P M	II-IT
80.	SHIVANI N	II-IT
81.	SIVASANKARI R	II-IT
82.	SREEMATHI INDRA S	II-IT
83.	SRIRAM S	II-IT
84.	THANESSHWARAN Y G	II-IT
85.	THUSMEENA K.R.	II-IT
86.	MEIYARASU K	I-EEE
87.	MONISA B	I-EEE

PRINCIPAL,
K. S. R. INSTITUTE FOR
ENGINEERING AND TECHNOLOGY,
K. S. R. KAVI NAGAR,
TIRUVALLUR, DISTRICT - 637 215,
TAMIL NADU.

88.	MYTHEYAN J	I-EEE
89.	NANDAKUMAR J	I-EEE
90.	NAVEEN N	I-EEE
91.	SANKAR S	I-EEE
92.	SARATHI VASAN J	I-EEE
93.	SAVURIYAPPAN S	I-EEE
94.	SRIDHAR D	I-EEE
95.	VIJAY E	I-EEE
96.	ATHIF L	I-EEE
97.	TAMILARASAN K	I-EEE
98.	TAMILSELVAN A	I-EEE
99.	PRASATH S	I-EEE
100.	DHATCHANAMOORTHY A	I-EEE
101.	GOKUL P	I-EEE
102.	GOKULRAJ P	I-EEE
103.	MAHESHKUMAR K S	I-CSE
104.	MUTHUSELVI A	I-CSE
105.	NAVEEN A	I-CSE

NSS PROGRAMME OFFICER

PRINCIPAL

PRINCIPAL
K. S. R. INSTITUTE FOR
ENGINEERING AND TECHNOLOGY,
K. S. R. KALVI NAGAR,
TIRUCHENGODE 637 213,
TAMIL NADU, INDIA.

K S R INSTITUTE FOR ENGINEERING AND TECHNOLOGY

TIRUCHENGODE – 637 215

NATIONAL SERVICE SCHEME (NSS)

Art of Meditation – Report

Academic Year: 2018-19

Name of the Programme	Art of Meditation		
Date & Time	26/06/2018 & 11:00 AM	Venue	Mechanical Seminar Hall
Chief Guest/Resource Person	Staff Members, EESHA Coimbatore	No of NSS Volunteers involved in the activity	22
		No of Beneficiaries	105
About Programme /Activity	Our KSRIET NSS Organized a program on “YOGA FOR HEALTHY LIFE” on 26 June, 2018. Seventy of our interested students participated in our Mechanical Seminar hall, KSRIET. 22 of our NSS Volunteers had arranged this program		



Art of Meditation

NSS Coordinator

 26/6/18

Principal

 K. S. R. INSTITUTE FOR
 ENGINEERING AND TECHNOLOGY,
 K. S. R. KALVI NAGAR,
 TIRUCHENGODE-637 215,
 NAMANKAL Dt, TAMIL NADU.

PERMISSION LETTER

From

The Co-ordinator,
Yoga Club,
KSRIET,
Tiruchengode.

To

The Principal,
KSRIET,
Tiruchengode.

Respected Sir,

Sub. :- Requesting permission to conduct Awareness Program on YOGA – Reg.

In view of International Yoga day, Yoga club of our college has planned to conduct “an awareness program on YOGA” for our faculty members on 21.06.2018. Hence you are requested to give permission and do the needful.

Thanking you.

Yours faithfully,

S. Chelladurai
19/6/18

[S.CHELLADURAI]

Date: 19-06-2018

Place: KSRIET, Tiruchengode.

[Handwritten signature]

[Handwritten signature]

PRINCIPAL,
K. S. R. INSTITUTE FOR
ENGINEERING AND TECHNOLOGY,
K. S. R. KALVI NAGAR,
TIRUCHENGODE-637 215,
NAMAKKAL Dt, TAMIL NADU.

K S R INSTITUTE FOR ENGINEERING AND TECHNOLOGY

TIRUCHENGODE - 637 215

Ref.: KSRIET/YOGA/CIR/2018-19/001

DATE: 20.06.2018

YOGA CLUB

CIRCULAR

This is to inform all the HoDs, Faculty members that our Yoga Club is organizing "Awareness Program on YOGA" for the faculty members on 21.06.2018 in view of International Yoga Day. In this regard, the willing faculty members are asked to assemble in ECE seminar hall at 10.00 am.



**COORDINATOR
(YOGA CLUB)**



PRINCIPAL



**PRINCIPAL,
K. S. R. INSTITUTE FOR
ENGINEERING AND TECHNOLOGY,
K. S. R. KALVI NAGAR,
TIRUCHENGODE-637 215,
NAMAKKAL Dt. TAMIL NADU.**

"Awareness programme on YOGA"

list of participants :

S.No.	NAME OF THE FACULTY MEMBER	DEPARTMENT
1	Mr. S. MADHAN	ENGLISH
2	Mr. R. KANAGASELVAM	ENGLISH
3	Dr. J. C. KANNAN	PHYSICS
4	Dr. B. KALAVATHI	CSE
5	Mrs. DEEPIKA	CSE
6	Mrs. MALATHI	CSE
7	Mr. JAWAHAR	CSE
8	Dr. A. MURUGESAN	EEE
9	Mr. VELMURUGAN	EEE
10	Mr. KRISHNA KUMAR	EEE
11	Dr. P. VEENA	EEE
12	Dr. T. SRIHARI	EEE
13	Dr. R. NANDHAKUMAR	ECE
14	Mr. T. MARTHANDAN	ECE
15	Mr. M. V. MAHESH	ECE
16	Mr. H. SENTHIL KUMAR	ECE
17	Ms. K. J. UMA	ECE
18	Mr. S. KARTHIK	ECE
19	Mrs. GOMATHI	ECE
20	Ms. P. SARANYA	ECE
21	Mr. PRAVEENKUMAR	ECE
22	Mrs. W. DEVAPRIYA	ECE
23	Mr. S. NANDHAKUMAR	ECE
24	Mr. N. DEEPAK	ECE
25	Mr. K. R. GOKUL ANAND	ECE
26	Mr. N. K. SHANKAR	ECE
27	Mr. SAMBATH	MECH
28	Mrs. SOBIYA	MECH
29	Mrs. UMA	MECH
30	Mr. KARTHI	MECH
31	Mr. RAMKUMAR	MECH
32	Mr. P. PREMKUMAR	MECH
33	Mr. J. MATHAN	MECH
34	Mr. M. V. SHANMUGAM	MECH
35	Mr. SATHISH KUMAR	MECH
36	Mrs. RUSSIA	IT
37	Mrs. DURGA DEVI	IT
38	Dr. P. MEENAKSHI DEVI	IT

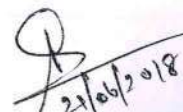

 PRINCIPAL,
 K. S. R. INSTITUTE FOR
 ENGINEERING AND TECHNOLOGY,
 K. S. R. KALVI NAGAR,
 TIRUCHENGODE-637 215,
 NAMAKKAL Dt, TAMIL NADU.

 23/06/2018
 CO-ORDINATOR
 [YOGA CLUB]

K S R INSTITUTE FOR ENGINEERING AND TECHNOLOGY

INTERNATIONAL YOGA DAY

AWARENESS PROGRAMME- 21.06.18



**PRINCIPAL,
K. S. R. INSTITUTE FOR
ENGINEERING AND TECHNOLOGY,
K. S. R. KALVI NAGAR,
TIRUCHENGOODE - 614 215,
NAMAKKAL DI, TAMIL NADU.**

Report Summary

Name of the Club:	Yoga Club		
Academic Year:	2018- 2019	Date & Time:	21.06.2018 & 9 am to 11 am
Name of the Programme:	“ Awareness programme on YOGA ”		
Venue:	EEE Seminar hall	No. of Participants Attended :	38

Brief about the Program:

In order to create awareness about YOGA among our college students & Faculty members, Yoga Club has been conducting awareness programme every year.

In this academic year (2018-19) also, we have conducted an awareness programme on YOGA on 21.06.2018 from 9 am to 11 am at our EEE seminar hall. Around **38** faculty members from various departments have participated in this awareness programme.

The Trainer Mrs. A. Priya from The Art of living, Erode have explained the importance of YOGA to keep our body and mind healthy & taught some simple Yoga Exercises by playing the videos.

This programme was very useful to our faculty members to keep both mental & physical health.



Coordinator

(Yoga Club)



Principal



PRINCIPAL,
K. S. R. INSTITUTE FOR
ENGINEERING AND TECHNOLOGY,
K. S. R. KALVI NAGAR,
TIRUCHENGODE-637 215,
NAMAKKAL DI, TAMIL NADU.

4. ICT/COMPUTING SKILLS

K S R INSTITUTE FOR ENGINEERING AND TECHNOLOGY

ICT/COMPUTING SKILLS CONSOLIDATED LIST

Academic Year:2018-2019

S.NO.	Name of the capability enhancement program	Date of implementation (DD-MM-YYYY)	Number of students enrolled	Name of the agencies/consultants involved with contact details (if any)
1	Internal C Programming Training	11.6.2018	360	KSRIET , placement@ksriet.ac.in
2	Genesys & Vuram Specific Training Specific Training	17.07.2018	23	Six Phrase Training Agency, Six Phrase@gmail.com
3	Robotic process automation	31.07.18	93	KSRIET , placement@ksriet.ac.in
4	Elintz Labs Training	21.09.2018	35	KSRIET , placement@ksriet.ac.in
5	Company Specific Training-Aspire Systems Training	27.09.2018	44	KSRIET , placement@ksriet.ac.in
6	Company Specific Training-VVDN Technologies Pvt Ltd	29.11.2018	23	KSRIET , placement@ksriet.ac.in
7	Company Specific Training-Go Speedy Go Tech Training	03.12.2018	19	KSRIET , placement@ksriet.ac.in

PRINCIPAL,
K. S. R. INSTITUTE FOR
ENGINEERING AND TECHNOLOGY,
K. S. R. KALVI NAGAR,
TIRUCHENGODE-637 215,
NAMAKKAL Dt, TAMIL NADU.

8	Clustrex data Private Limited Training Programme	06.12.2018	11	KSRIET , placement@ksriet.ac.in
9	Company Specific Training- Sanmar drive specific internal training programme	19.12.2018	19	KSRIET , placement@ksriet.ac.in
10	Skill Development Internal Language Training	11.12.2018	346	KSRIET , placement@ksriet.ac.in
11	External Training Programme-Algorithm Analysis & Stacks	19.01.2019	13	KSREI , ksreiplacement@gmail.com
12	Salesforce CRM Training	05.02.2019	12	ICT Academy, contact@ictacademy.in
13	Company Specific Training-Salesforce Employability Skill Training	06.02.2019	6	TNSDC (Support with ICT Academy, contact@ictacademy.in)
14	AUTOCAD	02.07.2018	101	ksriet,hod_mech@ksriet.ac.in
15	CREO- INDUSTRIAL DESIGN	04.06.2018	102	ksriet,hod_mech@ksriet.ac.in
16	SOLIDWORKS	28.05.2018	95	ksriet,hod_mech@ksriet.ac.in
17	CREO- AUTOMATION AND PRODUCTION	10.12.2018	69	ksriet,hod_mech@ksriet.ac.in

PRINCIPAL

ENGINEERING AND TECHNOLOGY,
K. S. R. KALVI NAGAR,
TIRUCHENGODE - 637 215,
NAMAKKAL Dt, TAMIL NADU.

Training Schedule [2018 - 2019] Odd Semester

Ref: KSRIET/T&P/CIR/2018-19

Date: 22.05.2018

This is to inform all the HoD's, Faculties & Department Training and Placement coordinators that the Internal Training for II year, III year & IV year PRP students on various topics for the academic year 2018 - 2019 (Odd Sem) has been scheduled. All the registered students should attend the Training Programme without fail. If any student skips this Training Programme without proper permission from the respective HoDs, he / she will not be permitted for any further Training Programme and campus recruitment process. Proper Dress Code is mandatory.

Encl.,

Detailed Training Schedule - Year Wise

T&P OFFICER

T&P COORDINATOR

PRINCIPAL

Copy to:

1. All HoDs
2. Notice Board

PRINCIPAL.
K. S. R. INSTITUTE FOR
ENGINEERING AND TECHNOLOGY,
K. S. R. KALVI NAGAR,
TIRUCHENGODE-637 215,
NAMAKKAL DI, TAMIL NADU.

K S R INSTITUTE FOR ENGINEERING AND TECHNOLOGY, TIRUCHENGODE - 637215

Training and placement Cell

II Year Training Schedule [Odd Semester]

Batch: 2017- 2021

Academic Year:2018- 2019

Branch	Day 1		Day 2		Day 3		Day 4		Day 5		Day 6	
	Date	Topics	Date	Topics	Date	Topics	Date	Topics	Date	Topics	Date	Topics
CSE	11.06.18	Basic Programming Skills in C	12.06.18	Basic Programming Skills in C	13.06.18	Basic Communication Skills	14.06.18	Basic Communication Skills	21.06.18	Basic Aptitude Skills	22.06.18	Basic Aptitude Skills
Faculty Name	CSE / IT Faculty		CSE / IT Faculty		Dr.C.Muhuntarajan HoD / English		Dr.C.Muhuntarajan HoD / English		Prof.M.S.Vijayaraj HoD / Maths		Prof.M.S.Vijayaraj HoD / Maths	
IT	11.06.18	Basic Programming Skills in C	12.06.18	Basic Programming Skills in C	13.06.18	Basic Aptitude Skills	14.06.18	Basic Aptitude Skills	25.06.18	Basic Communication Skills	26.06.18	Basic Communication Skills
Faculty Name	CSE / IT Faculty		CSE / IT Faculty		Prof.M.S.Vijayaraj HoD / Maths		Prof.M.S.Vijayaraj HoD / Maths		Dr.C.Muhuntarajan HoD / English		Dr.C.Muhuntarajan HoD / English	
EEE	11.06.18	Basic Programming Skills in C	12.06.18	Basic Programming Skills in C	21.06.18	Basic Communication Skills	22.06.18	Basic Communication Skills	25.06.18	Basic Aptitude Skills	26.06.18	Basic Aptitude Skills
Faculty Name	CSE / IT Faculty		CSE / IT Faculty		Dr.C.Muhuntarajan HoD / English		Dr.C.Muhuntarajan HoD / English		Prof.M.S.Vijayaraj HoD / Maths		Prof.M.S.Vijayaraj HoD / Maths	
ECE A	11.06.18	Basic Aptitude Skills	12.06.18	Basic Aptitude Skills	18.06.18	Basic Programming Skills in C	19.06.18	Basic Programming Skills in C	28.06.18	Basic Communication Skills	29.06.18	Basic Communication Skills
Faculty Name	Prof.M.S.Vijayaraj HoD / Maths		Prof.M.S.Vijayaraj HoD / Maths		CSE / IT Faculty		CSE / IT Faculty		Dr.C.Muhuntarajan HoD / English		Dr.C.Muhuntarajan HoD / English	
ECE B	11.06.18	Basic Communication Skills	12.06.18	Basic Communication Skills	18.06.18	Basic Programming Skills in C	19.06.18	Basic Programming Skills in C	28.06.18	Basic Aptitude Skills	29.06.18	Basic Aptitude Skills
Faculty Name	Dr.C.Muhuntarajan HoD / English		Dr.C.Muhuntarajan HoD / English		CSE / IT Faculty		CSE / IT Faculty		Prof.M.S.Vijayaraj HoD / Maths		Prof.M.S.Vijayaraj HoD / Maths	

PRINCIPAL.
K. S. R. INSTITUTE FOR
ENGINEERING AND TECHNOLOGY,
K. S. R. KALVI NAGAR,
TIRUCHENGODE-637 215,
NAMAKKAL Dt. TAMIL NADU.

Branch	Day 1		Day 2		Day 3		Day 4		Day 5		Day 6	
	Date	Topics	Date	Topics	Date	Topics	Date	Topics	Date	Topics	Date	Topics
MEC A	13.06.18	Basic Programming Skills in C	14.06.18	Basic Programming Skills in C	18.06.18	Basic Aptitude Skills	19.06.18	Basic Aptitude Skills	02.07.18	Basic Communication Skills	03.07.18	Basic Communication Skills
Faculty Name	CSE / IT Faculty		CSE / IT Faculty		Prof.M.S.Vijayaraj HoD / Maths		Prof.M.S.Vijayaraj HoD / Maths		Dr.C.Muhuntarajan HoD / English		Dr.C.Muhuntarajan HoD / English	
MEC B	13.06.18	Basic Programming Skills in C	14.06.18	Basic Programming Skills in C	18.06.18	Basic Communication Skills	19.06.18	Basic Communication Skills	02.07.18	Basic Aptitude Skills	03.07.18	Basic Aptitude Skills
Faculty Name	CSE / IT Faculty		CSE / IT Faculty		Dr.C.Muhuntarajan HoD / English		Dr.C.Muhuntarajan HoD / English		Prof.M.S.Vijayaraj HoD / Maths		Prof.M.S.Vijayaraj HoD / Maths	

V. K. K. K.
T & P OFFICER

[Signature]
T & P COORDINATOR 20/5/18

[Signature]
PRINCIPAL

✓
PRINCIPAL
K. S. R. INSTITUTE FOR
ENGINEERING AND TECHNOLOGY,
K. S. R. KALVI NAGAR,
TIRUCHENGODE-637 215,
NAMAKKAL DI, TAMIL NADU.

Training Topics			Aptitude Skills				Programming Skills in C				Communication Skills			
Trainer			Prof.M.S.Vijayaraj HoD/Maths				D. Balakrishnan AP/IT				Dr.C.Muhuntarajan HoD/Eng			
Trainng Date			11.06.18		12.06.18		18.06.18		19.06.18		28.06.18		29.06.18	
S. No		Name	FN	AN	FN	AN	FN	AN	FN	AN	FN	AN	FN	AN
1	731617106001	AARTHI G	a	a	a				DC					
2	731617106002	ABINAYA T	l	l	a	a	a	a	l	l	l	l	l	l
3	731617106003	ALKA P	a	a	l	l	l	l	l	l	l	l	l	l
4	731617106004	ANBAZHAGAN K	l	l	l	l	l	l	l	l	l	l	l	l
5	731617106005	ASHWINKUMAR V	←-----→				Discontinue				←-----→			
6	731617106006	BALAKUMARAN N	l	l	l	l	l	l	l	l	l	l	l	l
7	731617106007	BOOMA V	l	l	l	l	l	l	l	l	l	l	l	l
8	731617106008	DARANIDARAN R S	l	l	l	l	l	l	l	l	l	l	l	l
9	731617106009	DEEPA R	←-----→				DC				←-----→			
10	731617106010	DHANISH V	l	l	l	l	l	l	l	l	l	l	l	l
11	731617106011	DHANUSHKODI N	l	l	l	l	l	l	l	l	l	l	l	l
12	731617106012	DHARNISH K	l	l	l	l	l	l	l	l	l	l	l	l
13	731617106013	DHARSHAN T K	l	l	l	l	l	l	l	l	l	l	l	l
14	731617106014	DINESH U G	a	a	l	l	l	l	a	a	l	l	l	l
15	731617106015	DINNESH P	l	l	l	l	l	l	l	l	l	l	l	l
16	731617106016	GEETHARANI G	l	l	l	l	l	l	l	l	l	l	l	l
17	731617106017	GOKULNATH N	l	l	l	l	l	l	l	l	l	l	l	l
18	731617106018	GOKULNATH R	l	l	l	l	l	l	l	l	l	l	l	l
19	731617106019	GOWTHAM M	l	l	a	a	l	l	l	l	l	l	l	l
20	731617106020	HARI HARA SUDHAN R	l	l	l	l	l	l	l	l	l	l	l	l
21	731617106021	HARIKRISHNAN M	a	a	l	l	l	l	l	l	l	l	l	l
22	731617106022	HARISHKUMAR R	l	l	l	l	l	l	l	l	l	l	l	l
23	731617106023	HEMAHARINI S	l	l	l	l	l	l	l	l	l	l	l	l
24	731617106024	HEMALATHA S	a	a	l	l	l	l	l	l	l	l	l	l
25	731617106025	JANARTH S	l	l	l	l	l	l	l	l	l	l	l	l
26	731617106026	JANARTHANAN D	←-----→				DC				←-----→			
27	731617106027	JAWAHAR RAJA P	l	l	l	l	l	l	l	l	l	l	l	l
28	731617106028	KAMALESHWARAN R	a	a	l	l	l	l	l	l	l	l	l	l
29	731617106029	KAMALINI N	l	l	l	l	l	l	l	l	l	l	l	l
30	731617106030	KARTHIKA C	l	l	a	a	l	l	l	l	l	l	l	l
31	731617106031	KEERTHANA S	l	l	l	l	l	l	l	l	l	l	l	l
32	731617106032	KEERTHIVASAN N	a	a	l	l	l	l	l	l	l	l	l	l
33	731617106033	KISHOR M	a	a	l	l	l	l	l	l	l	l	l	l

PRINCIPAL.
K. S. R. INSTITUTE FOR
ENGINEERING AND TECHNOLOGY,
K. S. R. KALVI NAGAR,
TIRUCHENGODE-637 215,
NAMAKKAL DI, TAMIL NADU.

Trainng Date			11.06.18		12.06.18		18.06.18		19.06.18		28.06.18		29.06.18	
S. No		Name	FN	AN	FN	AN	FN	AN	FN	AN	FN	AN	FN	AN
34	731617106034	KISHORE D	/	/	/	/	/	/	/	/	/	/	/	/
35	731617106035	LAKSHMANAN S	/	/	/	/	/	/	/	/	/	/	/	/
36	731617106036	MADHANGOPAL C	/	/	a	a	/	/	/	/	/	/	a	a
37	731617106037	MANIMALA R	/	/	/	/	/	/	/	/	/	/	/	/
38	731617106038	MANJULA T	/	/	/	/	/	/	a	a	/	/	/	/
39	731617106039	MERINKUMAR L	/	/	/	/	/	/	/	/	/	/	/	/
40	731617106040	MUSHIDHA SIFANA T	/	/	/	/	/	/	/	/	/	/	/	/
41	731617106041	MUTHULAKSHMI S	a	a	/	/	/	/	/	/	/	/	/	/
PRESENT														
ABSENT														
PERMISSION														
OD														

PRINCIPAL.
K. S. R. INSTITUTE FOR
ENGINEERING AND TECHNOLOGY,
K. S. R. KALVI NAGAR,
TIRUCHENGODE-637 215,
NAMAKKAL Dt, TAMIL NADU.

Training Topics			Programming Skills in C				Aptitude Skills				Communication Skills			
Trainer			S Nandagopal AP/IT				Prof.M.S.Vijayaraj HoD/Maths				Dr.C.Muhuntarajan HoD/Eng			
Trainng Date			11.06.18		12.06.18		13.06.18		14.06.18		25.06.18		26.06.18	
S. No	Reg No	Name	FN	AN	FN	AN	FN	AN	FN	AN	FN	AN	FN	AN
1	731617205001	AJAY SRIRAM K	a	a	/	/	/	/	a	a	/	/	/	/
2	731617205002	ARULMOZHI M	/	/	/	/	/	/	/	/	/	/	/	/
3	731617205003	BABU U S	/	/	/	/	/	/	/	/	/	/	/	/
4	731617205004	BALAMURUGAN S	/	/	/	/	/	/	/	/	/	/	/	/
5	731617205005	CHANDRU M	/	/	/	/	/	/	/	/	/	/	/	/
6	731617205006	DHANUSH ADIT R	/	/	/	/	/	/	/	/	/	/	/	/
7	731617205007	DHINAKARAN B	/	/	/	/	/	/	/	/	/	/	/	/
8	731617205008	DINESH KUMAR P	/	/	/	/	/	/	/	/	/	/	/	/
9	731617205009	DIVYA P	a	a	a	a	a	a	a	a	a	a	a	a
10	731617205010	GIRINATH S	/	/	/	/	/	/	/	/	/	/	/	/
11	731617205011	GOBIKA M	a	a	/	/	/	/	/	/	/	/	/	/
12	731617205012	GOKULAN S	/	/	/	/	/	/	/	/	/	/	/	/
13	731617205013	HARIPRASATH K	/	/	/	/	/	/	a	a	/	/	/	/
14	731617205014	JESSICA COLLINS J P	/	/	/	/	/	/	/	/	/	/	/	/
15	731617205015	JOSHUA DANIEL B	/	/	/	/	/	/	/	/	/	/	/	/
16	731617205016	JOTHEESWARAN R	/	/	/	/	/	/	/	/	/	/	/	/
17	731617205017	KALAI KANNAN S	a	a	a	a	a	a	a	a	a	a	a	a
18	731617205018	KALIDASS R	/	/	/	/	/	/	/	/	/	/	/	/
19	731617205019	KANNAN P	/	/	/	/	/	/	a	/	/	/	/	/
20	731617205021	KARTHIK T	a	a	/	/	/	/	a	a	/	/	/	/
21	731617205022	KARTHIKEYAN M	/	/	/	/	/	/	/	/	/	/	/	/
22	731617205023	KAVIN I G	a	a	a	a	a	a	a	a	a	a	a	a
23	731617205024	KEERTHIVARMA K S	/	/	/	/	/	/	/	/	/	/	/	/
24	731617205025	LAKSHMANAN R	/	/	/	/	/	/	/	/	/	/	/	/
25	731617205026	MANIKANDAN A	/	/	/	/	/	/	a	a	/	/	/	/
26	731617205027	MOUNISH G	a	a	/	/	/	/	/	/	/	/	/	/
27	731617205028	MUKESH KANNA R	/	/	/	/	/	/	/	/	/	/	/	/
28	731617205029	MUKESHKANNAN T	a	a	a	a	a	a	a	a	a	a	a	a
29	731617205030	NANDHINI S	/	/	/	/	/	/	/	/	/	/	/	/
30	731617205031	NATHIYA V	/	/	/	/	/	/	/	/	/	/	/	/
31	731617205032	NAVEEN KUMAR G (30-12-1999)	/	/	/	/	/	/	a	a	/	/	/	/
32	731617205033	NAVEEN KUMAR G (14-06-2000)	a	a	/	/	/	/	/	/	/	/	/	/
33	731617205034	NIRMAL KUMAR S	/	/	/	/	/	/	/	/	/	/	/	/
34	731617205035	PAVITHRA S	/	/	/	/	/	/	a	a	/	/	a	a

PRINCIPAL,
K. S. R. INSTITUTE FOR
ENGINEERING AND TECHNOLOGY,
K. S. R. KALVI NAGAR,
TIRUCHENGODE-637 215,
NAMAKKAL Dt, TAMIL NADU.

Training Date			11.06.18		12.06.18		13.06.18		14.06.18		25.06.18		26.06.18	
S. No	Reg No	Name	FN	AN	FN	AN	FN	AN	FN	AN	FN	AN	FN	AN
35	731617205036	PRIYADHARSHINI P	/	/	/	/	a	a	a	a	a	a	/	/
36	731617205037	RAGU G	a	a	/	/	/	/	/	/	/	/	/	/
37	731617205038	RAJARAVEENDHAR G R	/	/	/	/	/	/	a	a	/	/	/	/
38	731617205039	SAANTHOSHBALAJI S N	/	/	a	a	/	/	/	/	/	/	/	/
39	731617205040	SANDHIYA G	/	/	/	/	/	/	/	/	/	/	/	/
40	731617205041	SANTHOSH KUMAR R	/	/	/	/	/	/	/	/	a	a	/	/
41	731617205042	SARAN V	/	/	/	/	/	/	/	/	a	a	/	/
42	731617205043	SATHAM M	/	/	/	/	/	/	/	/	/	/	/	/
43	731617205044	SATHISHKUMAR V	/	/	a	a	/	/	/	/	/	/	/	/
44	731617205045	SELVAMALAR P	/	/	/	/	a	a	/	/	/	/	/	/
45	731617205046	SHAILAA P M	/	/	/	/	/	/	a	a	/	/	/	/
46	731617205047	SHIVANI N	a	a	/	/	/	/	/	/	a	a	/	/
47	731617205048	SIVASANKARI R	/	/	/	/	/	/	/	/	/	/	/	/
48	731617205049	SREEMATHI INDRA S	/	/	/	/	a	a	a	a	/	/	/	/
49	731617205050	SRIRAM S	/	/	a	a	/	/	/	/	/	/	/	/
50	731617205051	THANESSHWARAN Y G	/	/	/	/	/	/	/	/	/	/	/	/
51	731617205052	THUSMEENA K R	/	/	/	/	/	/	/	/	a	/	/	/
52	731617205053	VENKATESHWARAN S	/	/	/	/	a	a	a	a	/	/	/	/
53	731617205054	VIMALRAJ G	/	/	a	a	/	/	/	/	/	/	/	/
54	731617205055	VINOTHINI R	/	/	/	/	/	/	/	/	/	/	/	/
PRESENT														
ABSENT														
PERMISSION														
OD														

PRINCIPAL,
K. S. R. INSTITUTE FOR
ENGINEERING AND TECHNOLOGY,
K. S. R. KALVI NAGAR
TIRUCHENGAI
NAIDIVELU-605 006

Training Topics			Programming Skills in C				Aptitude Skills				Communication Skills			
Trainer			Prakasam AP/CSE				Prof.M.S.Vijayaraj HoD/Maths				Dr.C.Muhuntarajan HoD/Eng			
Training Date			13.06.18		14.06.18		18.06.18		19.06.18		02.07.18		03.07.18	
S. No	Reg No	Name	FN	AN	FN	AN	FN	AN	FN	AN	FN	AN	FN	AN
1	731617114001	AADHI VISHWANATH M	/	/	/	/	/	/	/	/	/	/	/	/
2	731617114002	AJITH R	/	/	/	/	/	/	/	/	/	/	/	/
3	731617114003	ARAVIND S R	/	/	/	/	/	/	/	/	/	/	/	/
4	731617114004	ARUNESH J	/	/	/	/	/	/	/	/	/	/	/	/
5	731617114005	ARUN KUMAR S	/	/	/	/	/	/	/	/	/	/	/	/
6	731617114006	ARUN KUMAR T	/	/	/	/	/	/	/	/	/	/	/	/
7	731617114007	ARUN PRABAKARAN J	/	/	/	/	/	/	/	/	/	/	/	/
8	731617114008	ASWANTH KUMAR K	/	/	/	/	/	/	/	/	/	/	/	/
9	731617114009	ASWIN M	/	/	/	/	/	/	/	/	/	/	/	/
10	731617114010	BALAJI S	/	/	/	/	/	/	/	/	/	/	/	/
11	731617114011	BHAGAVATHI PERUMAL G	/	/	/	/	/	/	/	/	/	/	/	/
12	731617114012	BHARANIDHARAN R	/	/	/	/	/	/	/	/	/	/	/	/
13	731617114013	BOOPATHI S	/	/	/	/	/	/	/	/	/	/	/	/
14	731617114014	BOOPATHIRAJA M	/	/	/	/	/	/	/	/	/	/	/	/
15	731617114015	BUVANESVARAN S	/	/	/	/	/	/	/	/	/	/	/	/
16	731617114016	CHANDRU K	/	/	/	/	/	/	/	/	/	/	/	/
17	731617114017	CHANDRU M	/	/	/	/	/	/	/	/	/	/	/	/
18	731617114018	CHANDRU S	/	/	/	/	/	/	/	/	/	/	/	/
19	731617114019	DEEPAK K	/	/	/	/	/	/	/	/	/	/	/	/
20	731617114020	DHARANKUMAR S	/	/	/	/	/	/	/	/	/	/	/	/
21	731617114021	DHARSHAN C M	/	/	/	/	/	/	/	/	/	/	/	/
22	731617114022	DINESHKUMAR D	/	/	/	/	/	/	/	/	/	/	/	/
23	731617114023	DINESHKUMAR R	/	/	/	/	/	/	/	/	/	/	/	/
24	731617114024	DIVAGAR S (Discontinue)	/	/	/	/	/	/	/	/	/	/	/	/
25	731617114026	GOBIRAJ R	/	/	/	/	/	/	/	/	/	/	/	/
26	731617114027	GOKULNATH K	/	/	/	/	/	/	/	/	/	/	/	/
27	731617114028	GOKULPRASANTH M	/	/	/	/	/	/	/	/	/	/	/	/
28	731617114029	GOKULRAJ B	/	/	/	/	/	/	/	/	/	/	/	/
29	731617114030	GOVINDHARASU R	/	/	/	/	/	/	/	/	/	/	/	/
30	731617114031	GOWTHAM KUMAR T	/	/	/	/	/	/	/	/	/	/	/	/
31	731617114032	GUNASEELAN C	/	/	/	/	/	/	/	/	/	/	/	/
32	731617114033	HARIHARAN G	/	/	/	/	/	/	/	/	/	/	/	/
33	731617114034	HARIHARAN PR	/	/	/	/	/	/	/	/	/	/	/	/
34	731617114035	HARIPRASATH P	/	/	/	/	/	/	/	/	/	/	/	/

PRINCIPAL.

K. S. R. INSTITUTE FOR
ENGINEERING AND TECHNOLOGY,

K. S. R. KALVI NAGAR,

TIRUCHENGODE-637 215,

TAMIL NADU.

Training Date			13.06.18		14.06.18		18.06.18		19.06.18		02.07.18		03.07.18	
S. No	Reg No	Name	FN	AN	FN	AN	FN	AN	FN	AN	FN	AN	FN	AN
35	731617114036	HARIRAM B	/	/	/	/	/	/	/	/	/	/	/	/
36	731617114037	INDIRAJITH M	/	/	/	/	/	/	/	/	/	/	/	/
37	731617114038	JAGATHESHWARAN N	/	/	a	a	/	/	/	/	/	/	/	/
38	731617114039	KAMALESH T	/	/	/	/	/	/	/	/	/	/	/	/
39	731617114040	KARTHICK R	/	/	/	/	/	/	/	/	/	/	/	/
40	731617114041	KARTHIK A S	/	/	/	/	/	/	/	/	/	/	/	/
41	731617114042	KARTHIKEYAN S	/	/	/	/	/	/	/	/	/	/	/	/
42	731617114043	KARTHIKEYAN T	/	/	/	/	/	/	/	/	/	/	/	/
43	731617114044	KARUPPAIAH K	/	/	/	/	/	/	/	/	/	/	/	/
44	731617114045	KATHIRVEL M	/	/	/	/	/	/	/	/	/	/	/	/
45	731617114046	KAVIN M	/	/	/	/	/	/	/	/	/	/	/	/
46	731617114047	KAVIN M	/	/	/	/	/	/	/	/	/	/	/	/
47	731617114048	KAVINKUMAR C	/	/	/	/	/	/	/	/	/	/	/	/
48	731617114049	KAVIRAJ M	/	/	/	/	/	/	/	/	/	/	/	/
49	731617114050	KIRUBAKARAN K	/	/	/	/	/	/	/	/	/	/	/	/
50	731617114051	KIRUBAKARAN K	/	/	/	/	/	/	/	/	/	/	/	/
51	731617114052	LOGESH M	/	/	/	/	/	/	/	/	/	/	/	/
52	731617114053	MADESH K	/	/	/	/	/	/	/	/	/	/	/	/
53	731617114054	MANIKANDAN R	/	/	/	/	/	/	/	/	/	/	/	/
54	731617114055	MANOJ N	/	/	/	/	/	/	/	/	/	/	/	/
55	731617114056	MEIYANANDHAN V	/	/	/	/	/	/	/	/	/	/	/	/
56	731617114057	MOHAMED ABBAS M	/	/	/	/	/	/	/	/	/	/	/	/
PRESENT			54	54	50	50	/	/	55	55	54	54	52	52
ABSENT			1	1	3	3	0	0	0	0	1	1	-	-
PERMISSION			0	0	0	0	0	0	-	-	-	-	3	3
OD			0	0	0	0	-	-	-	-	-	-	-	-

PRINCIPAL,
K. S. R. INSTITUTE FOR
ENGINEERING AND TECHNOLOGY,
K. S. R. KALVI NAGAR,
TIRUCHENGODE-637 215,
NAMAKKAL DL, TAMIL NADU.

Training and Placement Cell

CSE - Internal Basic Communication, Aptitude & Programming In C Training Attendance

BATCH : 2017 - 2021

Academic Year: 2018 - 2019

Training Topics			Programming Skills in C				Communication Skills				Aptitude Skills			
Trainer			Sharmila AP/CSE				Dr.C.Muhuntarajan HoD/English				Prof.M.S.Vijayaraj HoD/Maths			
Training Date			11.06.18		12.06.18		9.06.18 13.06.18		10.06.18 14.06.18		21.06.18		22.06.18	
S. No	Reg No	Name	FN	AN	FN	AN	FN	AN	FN	AN	FN	AN	FN	AN
1	731617104001	ABINAYA S	a	a	l	l	l	l	l	l	l	l	l	l
2	731617104002	AGILAN R	a	a	l	l	l	l	l	l	l	l	l	l
3	731617104003	AKKIRAJU-SAI-CHARAN	a	a	l	l	l	l	l	l	l	l	l	l
4	731617104004	ARUN KUMAR N	l	l	a	a	l	l	l	l	l	l	a	a
5	731617104005	BABU R	l	l	l	l	a	a	l	l	a	a	l	l
6	731617104006	BOOPALAN V	a	a	l	l	l	l	l	l	l	l	l	l
7	731617104007	CHOWMIYA S B	l	l	a	a	l	l	l	l	l	l	a	a
8	731617104008	DEEPAK KUMAR J	a	a	l	l	l	l	l	l	a	a	l	l
9	731617104009	DERIL CHARLESS K	l	l	l	l	a	a	l	l	l	l	l	l
10	731617104010	DHARSHINI P	l	l	a	a	l	l	l	l	l	l	l	l
11	731617104011	DINESHKUMAR K (03-11-1999)	l	l	l	l	l	l	l	l	l	l	l	l
12	731617104012	DINESHKUMAR K (25-02-2000)	l	l	l	l	l	l	a	a	l	l	l	l
13	731617104013	ELANGO M	l	l	l	l	l	l	l	l	l	l	l	l
14	731617104014	GAYATHIRI M (19-05-2000)	a	a	l	l	l	l	l	l	l	l	l	l
15	731617104015	GAYATHIRI M (19-10-2000)	l	l	a	a	l	l	l	l	l	l	l	l
16	731617104016	GOWTHAM G	l	l	l	l	l	l	a	a	a	a	l	l
17	731617104017	GUNA M	a	a	l	l	l	l	l	l	l	l	l	l
18	731617104018	HARIHARAN S	l	l	l	l	a	a	l	l	l	l	a	a
19	731617104019	HARI KUMAR S	a	a	a	a	l	l	l	l	l	l	l	l
20	731617104020	HARISH P	l	l	l	l	l	l	l	l	a	a	l	l
21	731617104021	KAILASH K	l	l	l	l	l	l	a	a	l	l	l	l
22	731617104022	KARTHIKEYAN S	a	a	l	l	l	l	l	l	l	l	l	l
23	731617104023	KESAVAN S	l	l	a	a	l	l	l	l	l	l	l	l
24	731617104024	KISHOR P	l	l	l	l	l	l	l	l	l	l	a	a
25	731617104025	KOTEESHWARAN P N	a	a	l	l	l	l	l	l	l	l	l	l
26	731617104026	KRISHNAMOORTHY S	l	l	l	l	l	l	l	l	a	a	l	l
27	731617104027	MANORANJITH M	l	l	a	a	l	l	l	l	l	l	l	l
28	731617104028	MARIMUTHU R	a	a	a	a	l	l	l	l	l	l	l	l
29	731617104029	MENAGA T	l	l	l	l	a	a	l	l	l	l	l	l
30	731617104030	MOHAMED ABI VAKAAS S	l	a	l	l	l	l	l	l	l	l	l	l
31	731617104031	MOHANAPREYA N	a	a	l	l	l	l	l	l	l	l	l	l
32	731617104032	MONISH D	a	a	l	l	l	l	l	l	l	l	l	l
33	731617104033	MURALIDHARAN A	l	l	a	a	l	l	l	l	l	l	l	l
34	731617104034	POOJA M	l	l	l	l	l	l	l	l	l	l	a	a

PRINCIPAL,
K. S. R. INSTITUTE FOR
ENGINEERING AND TECHNOLOGY,
K. S. R. KALVI NAGAR,
TIRUCHENGODE-637 215,
NAMAKKAL DI, TAMIL NADU.

Trainng Date			11.06.18		12.06.18		13.06.18		14.06.18		21.06.18		22.06.18	
S.No	Reg No	Name	FN	AN	FN	AN	FN	AN	FN	AN	FN	AN	FN	AN
35	731617104035	POOJA SHREE K	/	a	a	a	/	/	/	/	/	/	/	/
36	731617104036	POOVARASAN S	/	/	/	/	/	/	a	a	/	/	/	/
37	731617104037	PRAKASH V	/	a	/	/	/	/	/	/	/	/	/	/
38	731617104038	PRASANTH N	/	/	a	a	/	/	/	/	a	a	/	/
39	731617104039	PRASANTH T	/	/	/	/	/	/	/	/	/	/	/	/
40	731617104040	PURUSOTHAMAN R	a	a	/	/	/	/	/	/	/	/	/	/
41	731617104041	RAJA SARAVANAN N S	/	/	/	/	/	/	/	/	a	a	/	/
42	731617104042	SANGEETHA M	/	/	a	a	/	/	/	/	/	/	/	/
43	731617104043	SANTHOSHKUMAR A	a	a	/	/	/	/	/	/	/	/	/	/
44	731617104044	SATHEESHKUMAR THANGAVEL	/	/	/	/	a	a	/	/	/	/	/	/
45	731617104045	SHARMILA A	/	/	a	a	/	/	/	/	/	/	a	a
46	731617104046	SNEHA P	a	a	/	/	/	/	/	/	/	/	/	/
47	731617104047	SOUNDHAR P	/	/	/	/	/	/	/	/	a	a	/	/
48	731617104048	SURYA K	/	/	/	/	/	/	/	/	/	/	/	/
49	731617104049	TAMILARASU K	Discontinue											
50	731617104050	VAISHNAVI V	/	/	/	/	/	/	a	a	/	/	/	/
51	731617104051	VALENTEENA COLLINS J P	a	a	/	/	/	/	/	/	/	/	/	/
52	731617104052	VEERALAKSHMI S	/	/	/	/	/	/	/	/	/	/	/	/
53	731617104053	VIGNESH M	/	/	a	a	/	/	/	/	/	/	/	/
54	731617104054	VIGNESH S	a	a	/	/	/	/	/	/	/	/	/	/
55	731617104055	VIJAY S	/	/	/	/	/	/	/	/	a	a	/	/
56	731617104057	YOKESH E	/	/	/	/	/	/	/	/	/	/	a	a
57	731617104058	YUVASHREE R	/	/	a	a	/	/	/	/	/	/	/	/
PRESENT														
ABSENT														
PERMISSION														
OD														

PRINCIPAL.
K. S. R. INSTITUTE FOR
ENGINEERING AND TECHNOLOGY,
K. S. R. KALVI NAGAR,
TIRUCHENGODE-637 215,
NAMAKKAL DI, TAMIL NADU.

K S R INSTITUTE FOR ENGINEERING AND TECHNOLOGY, Tiruchengode

Training and Placement Cell

EEE - Internal Basic Communication, Aptitude & Programming In C Training Attendance

BATCH : 2017 - 2021

Academic Year: 2018 - 2019

Training Topics			Programming Skills in C				Communication Skills				Aptitude Skills			
Trainer			D. Balakrishnan AP/IT				Dr.C.Muhuntarajan HoD/Eng				Prof.M.S.Vijayaraj HoD/Maths			
Trainng Date			11.06.18		12.06.18		21.06.18		22.06.18		25.06.18		26.06.18	
S. No	Reg No	Name	FN	AN	FN	AN	FN	AN	FN	AN	FN	AN	FN	AN
1	731617105001	ARUL M	/	/	/	/	/	/	/	/	/	/	/	/
2	731617105002	ASHA R	a	/	a	a	/	/	/	/	/	/	/	/
3	731617105003	BALAJI S	/	/	/	/	a	a	/	/	/	/	/	/
4	731617105004	BHARATH S	/	/	a	a	/	/	/	/	/	/	/	/
5	731617105005	DINESH C	a	a	/	/	/	/	/	/	/	/	/	/
6	731617105006	DINESH KUMAR T	/	/	/	/	/	/	/	/	/	/	/	/
7	731617105007	EZHILAN T	a	a	a	a	Discontinue							
8	731617105008	GOWTHAM S P	/	/	/	/	/	/	/	/	/	/	/	/
9	731617105009	GUGANESH R	/	/	/	/	/	/	/	/	/	/	/	/
10	731617105010	HARI S R	a	a	/	/	a	a	/	/	/	/	/	/
11	731617105011	HEMALATHA S	/	/	a	a	/	/	a	a	/	/	/	/
12	731617105012	JAYASURYA K	/	/	/	/	/	/	/	/	/	/	/	/
13	731617105013	JEEVANANDAM T	a	a	/	/	/	/	/	/	/	/	/	/
14	731617105014	JEEVITHA G	/	/	/	/	/	/	a	a	/	/	/	/
15	731617105015	JEGATHKUMAR S	/	/	/	/	/	/	/	/	/	/	/	/
16	731617105016	KAMALAHASAN G	/	/	/	/	/	/	/	/	/	/	/	/
17	731617105017	KARTHIKEYAN M	/	/	a	a	/	/	a	a	/	/	/	/
18	731617105018	KAVINKUMAR M	/	/	/	/	/	/	/	/	/	/	/	/
19	731617105019	KAVIN MUTHU KUMAR S	a	a	/	/	/	/	/	/	/	/	/	/
20	731617105020	KIRUBAKAR S	/	/	/	/	/	/	/	/	/	/	/	/
21	731617105021	LOGESWARAN C	/	/	a	a	/	/	/	/	/	/	/	/
22	731617105022	MANJUPRIYA M	/	/	/	/	/	/	/	/	a	a	/	/
23	731617105023	MANOJ KUMAR S	/	/	/	/	/	/	/	/	/	/	/	/
24	731617105024	MOHAN T	a	a	/	/	/	/	/	/	a	a	/	/
25	731617105025	NANDAKUMAARAN S	/	/	/	/	/	/	/	/	/	/	/	/
26	731617105027	PARAMASIVAM R	/	/	a	a	/	/	/	/	/	/	/	/
27	731617105028	PERARIVU EZHIL ARASAN T	/	/	/	/	/	/	/	/	/	/	/	/
28	731617105029	POOVARASAN J	/	/	a	a	/	/	/	/	/	/	/	/
29	731617105030	PRASATH S	a	a	a	a	a	a	a	a	a	a	a	a
30	731617105031	PRAVEEN KUMAR A	/	/	/	/	/	/	/	/	/	/	/	/
31	731617105032	PRAVEEN KUMAR M	/	/	/	/	/	/	/	/	/	/	/	/
32	731617105033	RAJAT KUMAR	a	a	a	a	/	/	a	a	/	/	/	/
33	731617105034	RAMYA A	/	/	/	/	/	/	/	/	/	/	/	/
34	731617105035	RAMYA P	/	/	/	/	/	/	/	/	/	/	/	/

PRINCIPAL.
K. S. R. INSTITUTE FOR
ENGINEERING AND TECHNOLOGY,
K. S. R. KALVI NAGAR,
TIRUCHENGODE-637 215,
NAMAKKAL Dt, TAMIL NADU.

Training Date			11.06.18		12.06.18		21.06.18		22.06.18		25.06.18		26.06.18	
S.No	Reg No	Name	FN	AN	FN	AN	FN	AN	FN	AN	FN	AN	FN	AN
35	731617105036	SAKTHIVEL P	/	/	/	/	/	/	/	/	/	/	/	/
36	731617105037	SANTHOSHKUMAR K	/	/	/	/	/	/	/	/	/	/	a	a
37	731617105038	SARANSARVESH M	/	/	/	/	/	/	/	/	/	/	/	/
38	731617105040	SASIKUMAR C	/	/	/	/	/	/	/	/	/	/	/	/
39	731617105041	SELVAM B	/	/	a	/	/	/	/	/	/	/	a	a
40	731617105042	SHAMEER S	/	/	/	/	/	/	/	/	/	/	/	/
41	731617105043	SHARMILAPRIYA S	/	/	/	/	/	/	/	/	/	/	/	/
42	731617105044	SHYAM PRASHAD S	/	/	/	/	/	/	/	/	/	/	/	/
43	731617105045	SILAMBARASAN S	a	a	/	/	/	/	/	/	/	/	/	/
44	731617105046	SUJITH S (11-02-2000)	/	/	/	/	/	/	/	/	/	/	a	a
45	731617105047	SUJITH S (11-07-2000)	/	/	/	/	/	/	/	/	/	/	/	/
46	731617105048	SUPRIYA K	/	/	/	/	/	/	/	/	/	/	/	/
47	731617105049	SURESH P	/	/	a	/	/	/	/	/	/	/	a	a
48	731617105050	SURYA P	/	/	/	/	/	/	/	/	/	/	/	/
49	731617105052	THAMIZHSELVAN R	/	/	/	/	/	/	/	/	/	/	a	a
50	731617105053	VALLARASU S	/	/	a	a	/	/	/	/	/	/	/	/
51	731617105054	VENKATESAN M	/	/	/	/	/	/	/	/	/	/	/	/
52	731617105055	VINOTH KUMAR R	/	/	/	/	/	/	/	/	/	/	/	/
PRESENT														
ABSENT														
PERMISSION														
OD														
NOT INTEREST														



PRINCIPAL,
K. S. R. INSTITUTE FOR
ENGINEERING AND TECHNOLOGY
K. S. R. KALVI NAGAR,
TIRUCHENGODE-637 215,
NAMAKKAL DL, TAMIL NADU.

K S R INSTITUTE FOR ENGINEERING AND TECHNOLOGY, Tiruchengode

Training and Placement Cell

ECE B - Internal Basic Communication, Aptitude & Programming In C Training Attendance

BATCH : 2017 - 2021

Academic Year: 2018 - 2019

Training Topics			Communication Skills				Programming Skills in C				Aptitude Skills			
Trainer			Dr.C.Muhuntarajan HoD/Eng				K G Lavanya AP/IT				Prof.M.S.Vijayaraj HoD/Maths			
Trainng Date			11.06.18		02.06.18		18.06.18		19.06.18		28.06.18		29.06.18	
S. No		Name	FN	AN	FN	AN	FN	AN	FN	AN	FN	AN	FN	AN
1	731617106042	NAVEEN L	/	/	/	/	/	/	/	/	/	/	/	/
2	731617106043	NAVEEN S S	/	/	/	/	/	/	/	/	/	/	a	a
3	731617106045	PARKAVI P	/	/	/	/	/	/	/	/	/	/	/	/
4	731617106046	PARKAVI S	/	/	/	/	/	/	/	/	/	/	/	/
5	731617106047	PAVITHRA T	/	/	/	/	/	/	/	/	/	/	/	/
6	731617106048	PREMELA R	/	/	/	/	/	/	/	/	/	/	/	/
7	731617106049	PRIYA R	/	/	/	/	/	/	a	a	/	/	/	/
8	731617106050	PRIYANKA V	a	a	/	/	/	/	/	/	/	/	/	/
9	731617106051	RAGHURAMACHANDIRAN V	/	/	/	/	/	/	/	/	/	/	/	/
10	731617106052	RAMYA S	/	/	/	/	/	/	/	/	/	/	/	/
11	731617106053	RANJITH M	/	/	/	/	/	/	/	/	/	/	/	/
12	731617106054	RESHMA K	/	/	/	/	a	a	/	/	/	/	/	/
13	731617106055	RUBAN PRASAD J	/	/	/	/	/	/	/	/	/	/	/	/
14	731617106056	SANDHIYA K	/	/	/	/	/	/	/	/	a	a	/	/
15	731617106057	SANTHIYA T	/	/	/	/	/	/	/	/	/	/	/	/
16	731617106058	SANTHIYA Y	/	/	/	/	/	/	/	/	/	/	/	/
17	731617106059	SANTHOSH K	/	/	/	/	/	/	/	/	/	/	/	/
18	731617106060	SHALINI V	/	/	/	/	/	/	a	a	/	/	/	/
19	731617106061	SHANMATHI M M	/	/	/	/	/	/	/	/	/	/	/	/
20	731617106062	SHARUMATHI S	/	/	/	/	/	/	/	/	/	/	/	/
21	731617106063	SINDUJA K	/	/	/	/	/	/	/	/	/	/	/	/
22	731617106064	SIVASANKARAN K	a	/	/	/	/	/	/	/	/	/	/	/
23	731617106065	SOFIA A	/	/	/	/	a	a	/	/	/	/	/	/
24	731617106066	SOWMIYA G V	/	/	/	/	/	/	/	/	/	/	/	/
25	731617106067	SREEMATHI G	/	/	/	/	/	/	/	/	/	/	/	/
26	731617106068	SRIDHARAN M	/	/	/	/	/	/	/	/	/	/	/	/
27	731617106069	SRINIVASAN A	/	/	/	/	/	/	/	/	/	/	/	/
28	731617106070	SRINIVASAN S R	/	/	/	/	/	/	a	/	/	/	/	/
29	731617106071	SRI RANJANI S	/	/	/	/	/	/	/	/	/	/	/	/
30	731617106073	SUBASH K	/	/	/	/	/	/	/	/	/	/	/	/
31	731617106074	SUDHA G	/	/	/	/	/	/	/	/	/	/	/	/
32	731617106075	SUKHESAN C	/	/	/	/	a	a	/	/	/	/	/	/
33	731617106076	SURESH K	/	/	/	/	/	/	/	/	/	/	/	/
34	731617106077	SURYAPRIYA K	/	/	/	/	/	/	/	/	/	/	/	/
35	731617106078	SUSHMITHA A	/	/	/	/	/	/	/	/	/	/	/	/

PRINCIPAL,
K. S. R. INSTITUTE FOR
ENGINEERING AND TECHNOLOGY,
K. S. R. KALVI NAGAR,
TIRUCHENGODE-637 215
NAMAKKAL Dt, TAMIL NADU.

Training Date			11.06.18		12.06.18		18.06.18		19.06.18		28.06.18		29.06.18	
S. No		Name	FN	AN	FN	AN	FN	AN	FN	AN	FN	AN	FN	AN
36	731617106079	SWEETLIN JOSHVA A	/	/	/	/	/	/	/	/	/	/	/	/
37	731617106080	SWETHA G P	/	/	/	/	/	/	/	/	/	/	/	/
38	731617106081	TAMILZHAGAN G	/	/	a	#	/	/	/	/	/	/	/	/
39	731617106082	TEJASWINI S	/	/	/	/	/	/	/	/	/	/	/	/
40	731617106083	THARUN KUMAR K	/	/	/	/	/	/	/	/	/	/	/	/
41	731617106084	THIYAGU M	/	/	/	/	/	/	/	/	/	/	/	/
42	731617106085	UDAYAKUMAR R	/	/	/	/	/	/	/	/	/	/	/	/
43	731617106086	YASODHA P	/	/	/	/	/	/	/	/	/	/	/	/
44	731617106087	YUVANSANKAR K	/	/	/	/	/	/	/	/	/	/	/	/
45	731617106088	ZUBAIR M	/	/	a	a	/	/	/	/	/	/	/	/
PRESENT			43	44	44	44	4	039	44	44	44	44	44	44
ABSENT			2	1	1	1	2	3	1	1	1	1	1	1
PERMISSION			-	-	-	-	3	3	+	+	+	+	+	+
OD			-	-	-	-	-	-	+	+	+	+	+	+

PRINCIPAL,
K. S. R. INSTITUTE FOR
ENGINEERING AND TECHNOLOGY,
K. S. R. KALVI NAGAR,
TIRUCHENGODE-637 215,
NAMAKKAL DI, TAMIL NADU.

Training Topics			Programming Skills in C				Communication Skills				Aptitude Skills			
Trainer			Sathiya Priya AP/CSE				Dr.C.Muhuntarajan HoD/Eng				Prof.M.S.Vijayaraj HoD/Maths			
Training Date			13.06.18		14.06.18		18.06.18		20.06.18		03.07.18		04.07.18	
S. No	Reg No	Name	FN	AN	FN	AN	FN	AN	FN	AN	FN	AN	FN	AN
1	731617114058	MOHANARAJ C	a	a	/	/	/	/	/	/	/	/	/	/
2	731617114059	MONISH KANNA M	/	/	/	/	/	/	/	/	/	/	/	/
3	731617114060	MUNEESWARAN D	/	/	/	/	/	/	a	a	a	a	/	/
4	731617114061	NANDHAKUMAR G	/	/	/	/	/	/	/	/	/	/	/	/
5	731617114062	NARESH M	/	/	/	/	/	/	/	/	/	/	a	a
6	731617114063	NAVEEN M	/	/	a	a	/	/	/	/	/	/	/	/
7	731617114064	NAVEEN V	/	/	/	/	/	/	/	/	/	/	/	/
8	731617114065	NIKHIL S	/	/	/	/	a	a	/	/	/	/	/	/
9	731617114066	NITHISH M	a	a	/	/	/	/	/	/	/	/	/	/
10	731617114067	PAVITHRAN G	/	/	/	/	/	/	a	a	a	a	/	/
11	731617114069	PRADEEP N	/	/	a	a	/	/	/	/	/	/	a	a
12	731617114070	PRADHAP R	/	/	/	/	/	/	/	/	/	/	/	/
13	731617114071	PRAGATHEESWAR E	/	/	/	/	/	/	/	/	/	/	/	/
14	731617114072	PRASATH R	/	/	/	/	/	/	/	/	/	/	/	/
15	731617114073	PRATHIYUMANAN M	/	/	/	/	/	/	/	/	/	/	/	/
16	731617114074	PRAVEEN H	/	/	/	/	a	a	/	/	/	/	/	/
17	731617114075	PRAVEENKUMAR V	a	a	/	/	/	/	/	/	/	/	/	/
18	731617114076	PRAVEEN KUMAR S	/	/	/	/	/	/	a	a	a	a	/	/
19	731617114077	PREMRAJ S	/	/	/	/	/	/	/	/	/	/	/	/
20	731617114078	RAHUL V	/	/	/	/	/	/	/	/	/	/	/	/
21	731617114079	RAMKUMAR B	/	/	/	/	/	/	/	/	/	/	/	/
22	731617114080	RANJITHKUMAR K	/	/	/	/	/	/	/	/	/	/	/	/
23	731617114081	SABARINATHAN S	/	/	/	/	/	/	/	/	/	/	a	a
24	731617114082	SAKTHIVEL P	/	/	/	/	a	a	/	/	/	/	/	/
25	731617114083	SANTHOSHKUMAR G	/	/	/	/	/	/	/	/	/	/	/	/
26	731617114084	SARAN KUMAR D	/	/	/	/	/	/	/	/	/	/	/	/
27	731617114085	SARATH KUMAR M	/	/	/	/	/	/	a	a	/	/	/	/
28	731617114086	SARAVANAA M	/	/	/	/	/	/	/	/	/	/	/	/
29	731617114087	SARAVANAN R	/	/	/	/	/	/	/	/	a	a	/	/
30	731617114088	SASIKARAN S	/	/	/	/	/	/	/	/	/	/	a	a
31	731617114089	SATHISHKUMAR S	/	/	/	/	a	a	/	/	/	/	/	/
32	731617114090	SHAJAHAN S	/	/	/	/	/	/	/	/	/	/	/	/
33	731617114091	SRIDHAR C	/	/	/	/	/	/	/	/	/	/	/	/
34	731617114092	SRIDHARAN R	/	/	/	/	/	/	/	/	/	/	/	/

PRINCIPAL

K. S. R. INSTITUTE FOR
ENGINEERING AND TECHNOLOGY,

" S. R. KALVI NAGAR,

TIRUCHENGODE-637 215,

TAMIL NADU.

Trainng Date			13.06.18		14.06.18		18.06.18		20.06.18		03.07.18		04.07.18	
S. No	Reg No	Name	FN	AN	FN	AN	FN	AN	FN	AN	FN	AN	FN	AN
35	731617114093	SURENDHAR P	/	/	/	/	/	/	/	/	/	/	/	/
36	731617114094	SURESHKUMAR A	/	/	/	/	/	/	/	/	/	/	/	/
37	731617114095	SURESHMOORTHY P	/	/	/	/	/	/	/	/	/	/	/	/
38	731617114096	SURYAMOORTHI R	/	/	/	/	/	/	/	/	/	/	/	/
39	731617114098	TAMILSELVAN V	/	/	/	/	/	/	/	/	/	/	/	/
40	731617114099	THAMIL SELVAM B	/	/	/	/	/	/	/	/	/	/	/	/
41	731617114100	THIRUPATHI M	/	/	/	/	/	/	/	/	/	/	/	/
42	731617114101	THULASI RAMAN R	/	/	/	/	/	/	/	/	/	/	/	/
43	731617114102	VIGNESH R	/	/	/	/	/	/	/	/	/	/	/	/
44	731617114103	VIGNESHWARAN S	/	/	/	/	/	/	/	/	/	/	/	/
45	731617114104	VIJAYAKUMAR C	/	/	/	/	/	/	/	/	/	/	/	/
46	731617114105	VINITH D	/	/	/	/	/	/	/	/	/	/	/	/
47	731617114106	VINOTH KUMAR T	/	/	/	/	/	/	/	/	/	/	/	/
48	731617114107	YASWANTHKARTHIKS	/	/	/	/	/	/	/	/	/	/	/	/
49	731617114108	YOGESH N	/	/	/	/	/	/	/	/	/	/	/	/
50	731617114301	R. Abhishek	/	/	/	/	/	/	/	/	/	/	/	/
51	731617114302	Dineshwaran .	/	/	/	/	/	/	/	/	/	/	/	/
52	731617114303	M.Hariprasad	/	/	/	/	/	/	/	/	/	/	/	/
53	731617114304	E.Kannan	/	/	/	/	/	/	/	/	/	/	/	/
54	731617114305	V.Manikandan	/	/	/	/	/	/	/	/	/	/	/	/
55	731617114306	Nantha kumar	/	/	/	/	/	/	/	/	/	/	/	/
PRESENT			42	42	47	47	42	42	46	46	48	48	46	46
ABSENT			4	4	3	3	6	6	6	6	5	5	9	9
PERMISSION			4	4	1	1	3	3	3	3	2	2	-	-
OD			-	-	-	-	-	-	-	-	-	-	-	-

PRINCIPAL,
K. S. R. INSTITUTE FOR
ENGINEERING AND TECHNOLOGY
K. S. R. KALM NAGAR,
TIRUCHENGODE-637 215.
NAMAKKAL DISTRICT.

Internal Basic Communication, Aptitude & Programming In C Training Attendance

BATCH: 2017 - 2021

ACADEMIC YEAR: 2018 - 2019 (ODD)

DATE: 11.06.2018

Fore Noon session

S.NO	BRANCH	STRENGTH	PRESENT	ABSENT	Leave
1	CSE	57	39	17	1
2	ECE - A	40	32	8	0
3	EEE	52	43	9	0
4	IT	54	43	11	0
Total		203	157	45	1

After Noon Session

S.NO	BRANCH	STRENGTH	PRESENT	ABSENT	PERMISSION
1	CSE	57	37	20	0
2	ECE - A	40	32	8	0
3	EEE	52	44	8	0
4	IT	54	43	11	0
Total		203	156	47	0

F. K. K. K.
T & P OFFICER
11/6/18

[Signature]
T & P CO ORDINATOR

[Signature]
PRINCIPAL

[Signature]
PRINCIPAL,
K. S. R. INSTITUTE FOR
ENGINEERING AND TECHNOLOGY,
K. S. R. KALVI NAGAR,
TIRUCHENGODE-637 215,
NAMAKKAL DI, TAMIL NADU.

Internal Basic Communication, Aptitude & Programming In C Training Attendance

BATCH: 2017 - 2021

ACADEMIC YEAR: 2018 - 2019 (ODD)

DATE: 12.06.2018

Fore Noon session

S.NO	BRANCH	STRENGTH	PRESENT	ABSENT	Leave
1	CSE	55	40	15	0
2	ECE - A	37	33	4	0
3	EEE	52	40	12	0
4	IT	54	46	8	0
Total		198	159	39	0

After Noon Session

S.NO	BRANCH	STRENGTH	PRESENT	ABSENT	PERMISSION
1	CSE	55	40	15	0
2	ECE - A	37	33	4	0
3	EEE	52	42	10	0
4	IT	54	46	8	0
Total		198	161	37	0

K. K. Kalvi
T & P OFFICER
12/06/18

T&P CO ORDINATOR
12/06/18

PRINCIPAL
12/06/18

PRINCIPAL
K. S. R. INSTITUTE FOR
ENGINEERING AND TECHNOLOGY,
K. S. R. KALVI NAGAR,
TIRUCHENGODE-637215
NAMAKKAL DISTRICT, TAMIL NADU.

Internal Basic Communication, Aptitude & Programming In C Training Attendance

BATCH: 2017 - 2021

ACADEMIC YEAR: 2018 - 2019 (ODD)

DATE: 13.06.2018

Fore Noon session

S.NO	BRANCH	STRENGTH	PRESENT	ABSENT	Leave
1	IT	54	46	8	0
2	MECH A	55	54	1	0
3	MECH B	50	42	4	4
Total		159	142	13	4

After Noon Session

S.NO	BRANCH	STRENGTH	PRESENT	ABSENT	PERMISSION
1	IT	54	46	8	0
2	MECH A	55	54	1	0
3	MECH B	50	42	4	4
Total		159	142	13	4

Y. Kalvi
T & P OFFICER

[Signature]
T&P CO ORDINATOR

PRINCIPAL

[Signature]
PRINCIPAL,
K. S. R. INSTITUTE FOR
ENGINEERING AND TECHNOLOGY,
K. S. R. KALVI NAGAR,
TIRUCHENGODE-637 215,
NAMAKKAL DI, TAMIL NADU.

Internal Basic Communication, Aptitude & Programming In C Training Attendance

BATCH: 2017 - 2021

ACADEMIC YEAR: 2018 - 2019 (ODD)

DATE: 14.06.2018

Fore Noon session

S.NO	BRANCH	STRENGTH	PRESENT	ABSENT	Leave
1	IT	54	39	15	0
2	MECH A	55	52	3	0
3	MECH B	51	47	3	1
Total		160	138	21	1

After Noon Session

S.NO	BRANCH	STRENGTH	PRESENT	ABSENT	PERMISSION
1	IT	54	39	15	0
2	MECH A	55	52	3	0
3	MECH B	51	47	3	1
Total		160	138	21	1

V. K. Kalvi
T&P OFFICER'S
14/6/18

[Signature]
T&P CO ORDINATOR
14/6/18

[Signature]
PRINCIPAL

PRINCIPAL,
K. S. R. INSTITUTE FOR
ENGINEERING AND TECHNOLOGY,
K. S. R. KALVI NAGAR,
TIRUCHENGODE-637 215,
NAMAKKAL DI, TAMIL NADU.

Internal Basic Communication, Aptitude & Programming In C Training Attendance

BATCH: 2017 - 2021

ACADEMIC YEAR: 2018 - 2019(ODD)

DATE: 18.06.2018

Fore Noon session

S.NO	BRANCH	STRENGTH	PRESENT	ABSENT	Leave
1	ECE A	37	36	1	0
2	ECE B	45	42	3	0
3	MECH A	55	53/40	0	2
4	MECH B	51	42	6	3
Total		188	173	10	5

After Noon Session

S.NO	BRANCH	STRENGTH	PRESENT	ABSENT	PERMISSION
1	ECE A	37	36	1	0
2	ECE B	45	42	3	0
3	MECH A	55	53/37	0	2
4	MECH B	51	42	6	3
Total		188	173	10	5

f. Kalyan
T & P OFFICER
18/6/18

T&P CO ORDINATOR
18/6/18

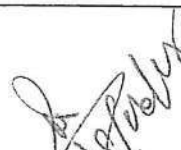
PRINCIPAL

PRINCIPAL,
K. S. R. INSTITUTE FOR
ENGINEERING AND TECHNOLOGY
K. S. R. KALVI NAGAR,
TIRUCHENGODE-637 215,
NAMAKKAL Dt, TAMIL NADU.

TRAINING & PLACEMENT CELL



Internal Basic Communication, Aptitude & Programming In C Training Attendance

BATCH: 2017 - 2021

ACADEMIC YEAR: 2018 - 2019 (ODD)

DATE: 19.06.2018

Fore Noon session

S.NO	BRANCH.	STRENGTH	PRESENT	ABSENT	Leave
1	ECE A	37	35	2	0
2	ECE B	45	40	2	3
3	MECH A	55	55	0	0
Total		137	130	4	3

After Noon Session

S.NO	BRANCH	STRENGTH	PRESENT	ABSENT	Leave
1	ECE A	37	35	2	0
2	ECE B	45	39	3	3
3	MECH A	55	55	0	0
Total		137	129	5	3

Y. K. K. K.
T & P OFFICER
19/6/18

A. S. S.
T&P CO ORDINATOR
19/6/18

A. S. S.
PRINCIPAL
19/6/18

(Green Checkmark)
PRINCIPAL,
K. S. R. INSTITUTE FOR
ENGINEERING AND TECHNOLOGY,
K. S. R. KALVI NAGAR,
TIRUCHENGODE-637 215,
NAMAKKAL DI, TAMIL NADU.

Internal Basic Communication, Aptitude & Programming In C Training Attendance

BATCH: 2017 - 2021

ACADEMIC YEAR: 2018 - 2019 (ODD)

DATE: 20.06.2018

Fore Noon session

S.NO	BRANCH	STRENGTH	PRESENT	ABSENT	Leave
1	MECH B	55	46	6	3
Total		55	46	6	3

After Noon Session

S.NO	BRANCH	STRENGTH	PRESENT	ABSENT	Leave
1	MECH B	55	46	6	3
Total		55	46	6	3

T & P OFFICER
20/6/18

T&P CO ORDINATOR

PRINCIPAL

PRINCIPAL,
K. S. R. INSTITUTE FOR
ENGINEERING AND TECHNOLOGY,
K. S. R. KALVI NAGAR,
TIRUCHENGODE-637 215,
NAMAKKAL DI, TAMIL NADU.

Internal Basic Communication, Aptitude & Programming In C Training Attendance

BATCH: 2017 - 2021

ACADEMIC YEAR: 2018 - 2019 (ODD)

DATE: 21.06.2018

Fore Noon session

S.NO	BRANCH	STRENGTH	PRESENT	ABSENT	Leave
1	CSE	55	46	9	0
2	EEE	51	49	1	1
Total		51	49	1	1

After Noon Session

S.NO	BRANCH	STRENGTH	PRESENT	ABSENT	Leave
1	CSE	55	46	9	0
2	EEE	51	49	1	1
Total		51	49	1	1

V. Kalvi
T & P OFFICER
21/6/18

[Signature]
21/6/18
T&P CO ORDINATOR

[Signature]
21/6/18
PRINCIPAL

[Green Checkmark]
PRINCIPAL
K. S. R. INSTITUTE FOR
ENGINEERING AND TECHNOLOGY,
K. S. R. KALVI NAGAR,
TIRUCHENGODE-637 215,
NAMAKKAL Dt, TAMIL NADU.

Internal Basic Communication, Aptitude & Programming In C Training Attendance

BATCH: 2017 - 2021

ACADEMIC YEAR: 2018 - 2019(ODD)

DATE: 22.06.2018

Fore Noon session

S.NO	BRANCH	STRENGTH	PRESENT	ABSENT	Leave
1	CSE	55	46	7	2
2	EEE	51	46	2	3
Total		51	46	2	3

T & P OFFICER
22/6/18

T & P CO ORDINATOR
22/06/18

PRINCIPAL
22/6/18

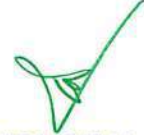
PRINCIPAL,
K. S. R. INSTITUTE FOR
ENGINEERING AND TECHNOLOGY,
K. S. R. KALVI NAGAR,
TIRUCHENGODE-637 215,
NAMAKKAL Dt, TAMIL NADU.

K S R INSTITUTE FOR ENGINEERING AND TECHNOLOGY, TIRUCHENGODE - 637215

TRAINING & PLACEMENT CELL



Internal Basic Communication, Aptitude & Programming In C Training Attendance

BATCH: 2017 - 2021

ACADEMIC YEAR: 2018 - 2019 (ODD)

DATE: 25.06.2018

Fore Noon session

S.NO	BRANCH	STRENGTH	PRESENT	ABSENT	Leave
1	IT	54	46	8	0
2	EEE	51	48	3	0
Total		105	94	11	0

After Noon session

S.NO	BRANCH	STRENGTH	PRESENT	ABSENT	Leave
1	IT	54	47	7	0
2	EEE	51	48	3	0
Total		105	95	10	0

T & P OFFICER

T & P CO ORDINATOR

PRINCIPAL

PRINCIPAL,
K. S. R. INSTITUTE FOR
ENGINEERING AND TECHNOLOGY,
K. S. R. KALVI NAGAR,
TIRUCHENGODE-637 215,
NAMAKKAL DI, TAMIL NADU.

Internal Basic Communication, Aptitude & Programming In C Training Attendance

BATCH: 2017 - 2021

ACADEMIC YEAR: 2018 - 2019 (ODD)

DATE: 26.06.2018

Fore Noon session

S.NO	BRANCH	STRENGTH	PRESENT	ABSENT	Leave
1	IT	54	49	4	1
2	EEE	51	46	5	0
Total		105	95	9	1

After Noon session

S.NO	BRANCH	STRENGTH	PRESENT	ABSENT	Leave
1	IT	54	49	4	1
2	EEE	51	46	5	0
Total		105	95	9	1

T & P OFFICER
26/6/18

T&P CO ORDINATOR
26/6/18

PRINCIPAL
26/6/18

PRINCIPAL,
K. S. R. INSTITUTE FOR
ENGINEERING AND TECHNOLOGY,
K. S. R. KALVI NAGAR,
TIRUCHENGODE-637 215,
NAMAKKAL DI, TAMIL NADU.

Internal Basic Communication, Aptitude & Programming In C Training Attendance

BATCH: 2017 - 2021

ACADEMIC YEAR: 2018 - 2019 (ODD)

DATE: 28.06.2018

Fore Noon session

S.NO	BRANCH	STRENGTH	PRESENT	ABSENT	Leave
1	ECE A	37	37	0	0
2	ECE B	45	44	1	0
Total		82	81	1	0

After Noon session

S.NO	BRANCH	STRENGTH	PRESENT	ABSENT	Leave
1	ECE A	37	37	0	0
2	ECE B	45	44	1	0
Total		82	81	1	0

[Handwritten Signature]
T & P OFFICER
28/6/18

[Handwritten Signature]
28/6/18
T&P CO ORDINATOR

[Handwritten Signature]
PRINCIPAL

[Green Stamp]
PRINCIPAL,
K. S. R. INSTITUTE FOR
ENGINEERING AND TECHNOLOGY,
K. S. R. KALVI NAGAR,
TIRUCHENGODE-637 215,
NAMAKKAL DE, TAMIL NADU.

Internal Basic Communication, Aptitude & Programming In C Training Attendance

BATCH: 2017 - 2021

ACADEMIC YEAR: 2018 - 2019 (ODD)

DATE: 29.06.2018

Fore Noon session

S.NO	BRANCH	STRENGTH	PRESENT	ABSENT	Leave
1	ECE A	37	36	1	0
2	ECE B	45	41	2	2
Total		82	77	3	2

After Noon session

S.NO	BRANCH	STRENGTH	PRESENT	ABSENT	Leave
1	ECE A	37	36	1	0
2	ECE B	45	41	2	2
Total		82	77	3	2

T & P OFFICER
29/6/18

T&P CO ORDINATOR
29/6/18

PRINCIPAL
29/6/18

PRINCIPAL,
K. S. R. INSTITUTE FOR
ENGINEERING AND TECHNOLOGY,
K. S. R. KALVI NAGAR,
TIRUCHENGODE-637 215,
NAMAKKAL Dt, TAMIL NADU.

Internal Basic Communication, Aptitude & Programming In C Training Attendance

BATCH: 2017 - 2021

ACADEMIC YEAR: 2018 - 2019 (ODD)

DATE: 03.07.18

Fore Noon session

S.NO	BRANCH	STRENGTH	PRESENT	ABSENT	Leave
1	MECH A	55	54	1	0
2	MECH B	55	48	5	2
Total		110	102	6	2

After Noon session

S.NO	BRANCH	STRENGTH	PRESENT	ABSENT	Leave
1	MECH A	55	54	1	0
2	MECH B	55	48	5	2
Total		110	102	6	2

[Signature]
T & P OFFICER
3/7/18

[Signature]
T&P CO ORDINATOR
3/7/18

[Signature]
PRINCIPAL

[Signature]
PRINCIPAL.
K. S. R. INSTITUTE FOR
ENGINEERING AND TECHNOLOGY,
K. S. R. KALVI NAGAR,
TIRUCHENGODE-637 215,
NAMAKKAL DI. TAMIL NADU.

K S R INSTITUTE FOR ENGINEERING AND TECHNOLOGY, TIRUCHENGODE - 637215

TRAINING & PLACEMENT CELL



Internal Basic Communication, Aptitude & Programming In C Training Attendance

BATCH: 2017 - 2021

ACADEMIC YEAR: 2018 - 2019 (ODD)

DATE: 04.07.2018

Fore Noon session

S.NO	BRANCH	STRENGTH	PRESENT	ABSENT	Leave
1	MECH A	55	52	0	3
2	MECH B	55	46	9	0
Total		110	98	9	3

After Noon session

S.NO	BRANCH	STRENGTH	PRESENT	ABSENT	Leave
1	MECH A	55	52	0	3
2	MECH B	55	46	9	0
Total		110	98	9	3

V. Kalish
T & P OFFICER

[Signature]
T & P CO ORDINATOR

[Signature]
PRINCIPAL

[Signature]
PRINCIPAL,
K. S. R. INSTITUTE FOR
ENGINEERING AND TECHNOLOGY,
K. S. R. KALVI NAGAR,
TIRUCHENGODE-637 215,
NAMAKKAL DL, TAMIL NADU.

Internal Basic Communication, Aptitude & Programming In C Training Attendance

BATCH: 2017 - 2021

ACADEMIC YEAR: 2018 - 2019 (ODD)

DATE: 01.08.2018

Fore Noon session

S.NO	BRANCH	STRENGTH	PRESENT	ABSENT	Leave
1	ECE B	45	43	2	0
Total		45	43	2	0

After Noon session

S.NO	BRANCH	STRENGTH	PRESENT	ABSENT	Leave
1	ECE B	45	43	1	0
Total		45	43	1	0

BATCH: 2017 - 2021

ACADEMIC YEAR: 2018 - 2019 (ODD)

DATE: 02.08.2018

Fore Noon session

S.NO	BRANCH	STRENGTH	PRESENT	ABSENT	Leave
1	ECE B	45	43	1	0
Total		45	43	1	0

After Noon session

S.NO	BRANCH	STRENGTH	PRESENT	ABSENT	Leave
1	ECE B	45	43	1	0
Total		45	43	1	0

 T & P OFFICER
 21/8/18

 T & P CO ORDINATOR

 PRINCIPAL

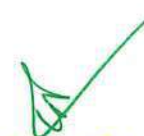
 PRINCIPAL.
 K. S. R. INSTITUTE FOR
 ENGINEERING AND TECHNOLOGY,
 K. S. R. KALVI NAGAR,
 TIRUCHENGODE-637 215,
 NAMAKKAL Dt, TAMIL NADU.

Internal Basic Communication, Aptitude & Programming In C Training Attendance

BATCH: 2017 - 2021

ACADEMIC YEAR: 2018 - 2019 (ODD)

DATE: 09.08.2018

Fore Noon session

S.NO	BRANCH	STRENGTH	PRESENT	ABSENT	Leave
1	CSE	55	50	5	0
Total		55	50	5	0

After Noon session

S.NO	BRANCH	STRENGTH	PRESENT	ABSENT	Leave
1	CSE	55	50	5	0
Total		55	50	5	0

BATCH: 2017 - 2021

ACADEMIC YEAR: 2018 - 2019 (ODD)

DATE: 10.08.2018

Fore Noon session

S.NO	BRANCH	STRENGTH	PRESENT	ABSENT	Leave
1	CSE	55	50	5	0
Total		55	50	5	0

After Noon session

S.NO	BRANCH	STRENGTH	PRESENT	ABSENT	Leave
1	CSE	55	50	5	0
Total		55	50	5	0

T & P OFFICER
10/8/18

T&P CO ORDINATOR

PRINCIPAL

PRINCIPAL,
K. S. R. INSTITUTE FOR
ENGINEERING AND TECHNOLOGY,
K S R KALVI NAGAR,
TIRUCHENGODE-637 215,
NARAIKAL DI, TAMIL NADU.



TRAINING PROGRAMME FEEDBACK FORM

Name of the Student: Hari Prasad Branch: B.TECH/IT

Year / Sem: II / 3

4. Name of the Training: Programming Skills in C

5. Name of the Trainer: Nanda Mr. Nandagopal

6. Students rating of Trainers :

S. No.	Date	Subject	Rating (√)			
			Excellent	Very good	Good	Average
1	11.6.2018	Programming in C			✓	

4. Two positive points about the programme:

It is very useful for all.

It face a complicated questions

5. Suggestions for improvement:

It is useful to improve my programming skills.

Date: 11.6.2018

Signature

K. Hari Prasad



TRAINING PROGRAMME FEEDBACK FORM

Name of the Student: SHIVANI Branch: IT

Year / Sem: II / III

1. Name of the Training: Basic Programming in C

2. Name of the Trainer: Ms. Nandha Gopal

3. Students rating of Trainers :

S. No.	Date	Subject	Rating (√)			
			Excellent	Very good	Good	Average
1	11/06/18	Basic in C			✓	

4. Two positive points about the programme:

We regain the knowledge & basis in

C Programming

5. Suggestions for improvement:

Teach with example program based on

concepts

N. Shif.

Date: 11/06/18

Signature

**K S R INSTITUTE FOR ENGINEERING AND TECHNOLOGY
TIRUCHENGODE - 637 215**

TRAINING PROGRAMME FEEDBACK FORM



Name of the Student: S. HEMALATHA

Branch: B.E / EEE

Year / Sem: II / III

1. Name of the Training: Programming skills in C

2. Name of the Trainer: D. Balakrishnan

3. Students rating of Trainers :

- 1) Greatest of 3 no.s
- 2) Prime or not
- 3) Factorial
- 4) Table using do while

S. No.	Date	Subject	Rating (√)			
			Excellent	Very good	Good	Average
1	11-06-18	C-Program (intro) data types, looping, process, decision making	✓			

4. Two positive points about the programme: Developing in computer language as problem solving technique

5. Suggestions for improvement: Give more problems to solve

Date: 11-06-18

[Signature]
Signature

**K S R INSTITUTE FOR ENGINEERING AND TECHNOLOGY
TIRUCHENGODE - 637 215**

TRAINING PROGRAMME FEEDBACK FORM



Name of the Student: T. EZHILAN

Branch: B.E. EEE

Year / Sem: II / III

4. Name of the Training: Programming skills in C

5. Name of the Trainer: D. Bala Krishnan

6. Students rating of Trainers :

S. No.	Date	Subject	Rating (√)			
			Excellent	Very good	Good	Average
1	11.6.2018	C-Programming	✓			

4. Two positive points about the programme: Very kind and easy handling us in subject wise

5. Suggestions for improvement: Explicitly solve problems how to solve

Date: 11.6.2018

PRINCIPAL
K. S. R. INSTITUTE FOR
ENGINEERING AND TECHNOLOGY,
K. S. R. KAVELI NAGAR,
TIRUCHENGODE-637 215,
NAMAKKAL Dt, TAMIL NADU.

[Signature]
Signature



Name of the Student: P. N. KOTEESHWARAN

Branch: CSE

Year / Sem: 11 / III

1. Name of the Training: Programming skills in C.

2. Name of the Trainer: SHRMIKA N. S

3. Students rating of Trainers :

S. No.	Date	Subject	Rating (√)			
			Excellent	Very good	Good	Average
1	11.06.18	Basic Programming in 'C'	✓			

4. Two positive points about the programme:

Basic things of the programming was explained clearly.

5. Suggestions for improvement:

Date: 11/6/18

P. N. Koteeshwaran
Signature



Name of the Student: P. Sneha

Branch: CSE

Year / Sem: 11 / III

4. Name of the Training: Programming skills in C.

5. Name of the Trainer: SHRMIKA N. S

6. Students rating of Trainers :

S. No.	Date	Subject	Rating (√)			
			Excellent	Very good	Good	Average
1	11.06.2018	Basic Programming in C	✓			

4. Two positive points about the programme:

All codings are explained step by step by understanding them clearly.

5. Suggestions for improvement:

Give some clear program to solve.

Date: 11/6/18

PRINCIPAL,
K. S. R. INSTITUTE FOR
ENGINEERING AND TECHNOLOGY,
K. S. R. KALVI PAGER,
TIRUCHENGODE-637 215,
NAMAKKAL Dt, TAMIL NADU.

P. Sneha
Signature



Name of the Student: P. DINNESH

Branch: BE/ECE

Year / Sem: II / III

1. Name of the Training: APTITUDE SKILLS

2. Name of the Trainer: Mr. VISAYARAJ

3. Students rating of Trainers: 9/10

S. No.	Date	Subject	Rating (✓)			
			Excellent	Very good	Good	Average
1	11/06/18	Maths	✓			

4. Two positive points about the programme:
 * Our aptitude skill will be improved and we can solve the problems easily.

5. Suggestions for improvement:
 * Easy for us to place and clear the aptitude level.
 More problems can be practised

Date: 11/06/2018

Signature P. Dinnesh



Name of the Student: S. Keerthana

Branch: BE/ECE

Year / Sem: II / 3

4. Name of the Training: Aptitude

5. Name of the Trainer: Mr. Vijayaraj

6. Students rating of Trainers: 8.56

S. No.	Date	Subject	Rating (✓)			
			Excellent	Very good	Good	Average
1	11/6/18	Aptitude.		✓		

4. Two positive points about the programme:
 * It is easy to solve as it involves basic mathematics.

5. Suggestions for improvement:
 * It is the basic requirement for all entrance exams.
 [Nothing] for K. S. R. INSTITUTE FOR ENGINEERING AND TECHNOLOGY, K. S. R. KALVI NAGAR, TIRUCHENGODE-637 215, NAMAKKAL Dt, TAMIL NADU.

Date: 11/6/18

Signature [Signature]



TRAINING PROGRAMME FEEDBACK FORM

Name of the Student: THAMIZHSELVAN R Branch: EEE

Year / Sem: II / III

4. Name of the Training: C programming.

5. Name of the Trainer: BALAKRISHNAN

6. Students rating of Trainers :

S. No.	Date	Subject	Rating (√)			
			Excellent	Very good	Good	Average
1	11.6.18, 12-6-18	'C' program Basic		✓		

4. Two positive points about the programme: known about basic 'C' programming.

5. Suggestions for improvement: learn 'C' language

Date: 12.6.18

R. ThamizhSelvan
Signature



TRAINING PROGRAMME FEEDBACK FORM

Name of the Student: Muthulakshmi S Branch: ECB-A

Year / Sem: 2nd / 3rd

1. Name of the Training: APTITUDE

2. Name of the Trainer: Vijay Raj

3. Students rating of Trainers : 9

S. No.	Date	Subject	Rating (√)			
			Excellent	Very good	Good	Average
1	12.6.18	APTITUDE				

4. Two positive points about the programme: He teach very clearly

5. Suggestions for improvement: -

Date: 12.6.18

S. Raj
Signature

[Signature]
PRINCIPAL
K. S. R. INSTITUTE FOR
ENGINEERING AND TECHNOLOGY,
K. S. R. KALVI NAGAR,
TIRUCHENGODE-637 215,
NAMAKKAL DISTRICT, TAMIL NADU.

TRAINING PROGRAMME FEEDBACK FORM

Name of the Student: R. Hari Hara Sudhan

Branch: EEE-A

Year / Sem: 2nd / 3rd

4. Name of the Training: VIJAYRAJ (APTITUDE)

5. Name of the Trainer: VIJAYRAJ

6. Students rating of Trainers: 9.5

S. No.	Date	Subject	Rating (✓)			
			Excellent	Very good	Good	Average
1	12/6/18	APTITUDE	✓			

4. Two positive points about the programme:

Good planning
Good teaching

5. Suggestions for improvement: -

Signature

Date: 12/6/18

TRAINING PROGRAMME FEEDBACK FORM

Name of the Student: T. Mohan

Branch: EEE

Year / Sem: II / III

1. Name of the Training: c programming basics

2. Name of the Trainer:

3. Students rating of Trainers: Balakrishnan

S. No.	Date	Subject	Rating (✓)			
			Excellent	Very good	Good	Average
1	11-06-18	c-Programs			✓	

4. Two positive points about the programme:

1] learnt about c basics
2] learnt basic problem solving technique

5. Suggestions for improvement:

Teach some more basics in c

PRINCIPAL
K. S. R. INSTITUTE FOR
ENGINEERING AND TECHNOLOGY,
K. S. R. KALVI NAGAR,
TIRUCHENGODE-637 215,
NAMAKKAL DISTRICT, TAMIL NADU.

Signature



Name of the Student: N. MOHANAPREYA

Branch: B.E - CSE

Year / Sem: i / iii

1. Name of the Training: C Programming

2. Name of the Trainer: N. Sharmila

3. Students rating of Trainers :

S. No.	Date	Subject	Rating (√)			
			Excellent	Very good	Good	Average
1	12.6.18	C Programming	✓			

4. Two positive points about the programme: Can able to learn the C Programming in detail.

Can able to review and getting thorough in the language

5. Suggestions for improvement:

Extend the classes for one more day.

Date: 12.6.18

N. Mohanap
Signature



Name of the Student: ARVINKUMAR N

Branch: B.E. CSE

Year / Sem: 02 II / 03

4. Name of the Training: C programming

5. Name of the Trainer: N. Sharmila

6. Students rating of Trainers :

S. No.	Date	Subject	Rating (√)			
			Excellent	Very good	Good	Average
1	12.6.18	C programming			✓	

4. Two positive points about the programme:

To get clear idea about the principle of the program

5. Suggestions for improvement:

Want next level programs

teaching base

Want next level in programs.

Date: 12.6.18

PRINCIPAL
K. S. R. INSTITUTE FOR
ENGINEERING AND TECHNOLOGY,
K. S. R. KALVI NAGAR,
TIRUCHENGODE - 637 215,
NAMAKKAL DI, TAMIL NADU.

[Signature]
Signature



Name of the Student: R. Senthil Kumar

Branch: B. TECH-IT

Year / Sem: I yr / III Sem

1. Name of the Training: Programming in C

functions
structure

2. Name of the Trainer: Nandagopal

3. Students rating of Trainers :

S. No.	Date	Subject	Rating (√)			
			Excellent	Very good	Good	Average
1	12.06.18	Programming in C		✓		

4. Two positive points about the programme: * we have done most of the programmes

* level of teaching by staff was good

5. Suggestions for improvement: * apart from basics, many new and advanced concepts can be taught with practice

Date: 12.06.18

R. Senthil Kumar
Signature



Name of the Student: M. GOBIKA

Branch: IT

Year / Sem: II / III

4. Name of the Training: Programming in C

5. Name of the Trainer: Nandagopal

6. Students rating of Trainers :

S. No.	Date	Subject	Rating (√)			
			Excellent	Very good	Good	Average
1	12.06.18	PROGRAMMING IN C		✓		

4. Two positive points about the programme: In this class we got the basic ideas about the programming language. Recalling of the basics made us to get clear ideas which programming skill beginning to our

5. Suggestions for improvement:

Exercises to get practised.

Date: 12.06.18

PRINCIPAL
K. S. R. INSTITUTE FOR
ENGINEERING AND TECHNOLOGY,
K. S. R. KALVI NAGAR,
TIRUCHENGODE-637 215
NAMAKKAL DI, TAMIL NADU

M. Gobika
Signature

**K S R INSTITUTE FOR ENGINEERING AND TECHNOLOGY
TIRUCHENGODE - 637 215**

TRAINING PROGRAMME FEEDBACK FORM



Name of the Student: ARUNI KUMAR S

Branch: B.E - MECH - "A"

Year / Sem: II / 3-Sem

1.Name of the Training :

2.Name of the Trainer :

3.Students rating of Trainers :

S. No.	Date	Subject	Rating (√)			
			Excellent	Very good	Good	Average
1	13.06.2018	CSC	✓			

4. Two positive points about the programme: we have learnt new language
It will help us to improve our programming skills.

5. Suggestions for improvement:

The class can hold more in the lab.

Date:

S. Arun
Signature

**K S R INSTITUTE FOR ENGINEERING AND TECHNOLOGY
TIRUCHENGODE - 637 215**

TRAINING PROGRAMME FEEDBACK FORM



Name of the Student: Ajith Kumar R

Branch: B.E - mech - "A"

Year / Sem: II / 3-sem

4.Name of the Training :

5.Name of the Trainer :

6.Students rating of Trainers :

S. No.	Date	Subject	Rating (√)			
			Excellent	Very good	Good	Average
1	13.06.2018	CSC	✓			

4. Two positive points about the programme: we have learnt new language.
It will help us to improve our programming skills.

5. Suggestions for improvement:

The class can hold more in the lab.

Date:

Principal,
K. S. R. INSTITUTE FOR
ENGINEERING AND TECHNOLOGY,
K. S. R. KALVI NAGAR,
TIRUCHENGODE-637 215
NAMAKKAL Dt, TAMIL NADU.
R. Arun
Signature



Name of the Student: C. Mohanaraj

Branch: Mech - R

Year / Sem: II / III

1. Name of the Training: Soft Skills

2. Name of the Trainer: Sathyapriya

3. Students rating of Trainers: 4/5

S. No.	Date	Subject	Rating (✓)			
			Excellent	Very good	Good	Average
1	13/6/18	C Programming	✓			

4. Two positive points about the programme:

- i) Good in teaching
- ii) Good communication.

5. Suggestions for improvement:

- i) Applications needed

Date: 13/6/18 - FN

C. Mohanaraj

Signature



Name of the Student: R. Saravanan

Branch: Mech - B

Year / Sem: II / IV

4. Name of the Training: Soft Skills

5. Name of the Trainer: Sathyapriya

6. Students rating of Trainers: 4/5

S. No.	Date	Subject	Rating (✓)			
			Excellent	Very good	Good	Average
1	13/6/18	C Programming	✓			

4. Two positive points about the programme:

- i) Good in teaching
- ii) Good communication

5. Suggestions for improvement:

- (i) Applications needed

Date: 13/6/18 - AN

PRINCIPAL.
K. S. R. INSTITUTE FOR
ENGINEERING AND TECHNOLOGY,
K. S. R. KALVI NAGAR,
TIRUCHENGODE-637 215,
NAMAKKAL DT. TAMIL NADU.

R. Saravanan

Signature



TRAINING PROGRAMME FEEDBACK FORM

Name of the Student: J.P. Jessica Collins

Branch: B.Tech/IT

Year / Sem: II / III

1. Name of the Training: APS Skill

2. Name of the Trainer: Mr. Vijayaraj Siv

3. Students rating of Trainers :

S. No.	Date	Subject	Rating (√)			
			Excellent	Very good	Good	Average
1	13.6.18	maths	✓			

Topic - Time & work, pipes and cisterns, time, speed distance

4. Two positive points about the programme:
 • Was very easy to cope up with
 • ppt was useful.

5. Suggestions for improvement:

Date: 13.6.18

Signature J.P.



TRAINING PROGRAMME FEEDBACK FORM

Name of the Student: R. Dhanush Adit

Branch: B. tech/IT

Year / Sem: II / III

4. Name of the Training: APS skill

5. Name of the Trainer: Mr. Vijayaraj Siv

6. Students rating of Trainers :

S. No.	Date	Subject	Rating (√)			
			Excellent	Very good	Good	Average
1	13.6.18	Maths	✓			

Topic - Time and work, pipes and cisterns, time, speed distance

4. Two positive points about the programme:
 • ppt presentation was very good

5. Suggestions for improvement:

we want more example

Date: 13.6.18

every each topics

PRINCIPAL.
K. S. R. INSTITUTE FOR
ENGINEERING AND TECHNOLOGY,
K. S. R. KALVI NAGAR,
TIRUCHENGODE-637 215,
NAMAKKAL Dt, TAMIL NADU.

Signature R. Dhanush

**K S R INSTITUTE FOR ENGINEERING AND TECHNOLOGY
TIRUCHENGODE - 637 215**

TRAINING PROGRAMME FEEDBACK FORM



Name of the Student: THANESHWARAN Y.G Branch: IT / IInd Year

Year / Sem: 2nd Year / 3rd Sem

1. Name of the Training: Aptitude Skill training

2. Name of the Trainer: Mr. S. Vijayaraj

3. Students rating of Trainers :

S. No.	Date	Subject	Rating (√)			
			Excellent	Very good	Good	Average
1	14.06.18	Aptitude		✓		

4. Two positive points about the programme:

we learn all the 6 topics

5. Suggestions for improvement:

NO

Date: 14.06.2018

Thanesw Y.G
Signature

**K S R INSTITUTE FOR ENGINEERING AND TECHNOLOGY
TIRUCHENGODE - 637 215**

TRAINING PROGRAMME FEEDBACK FORM



Name of the Student: Dracemathi Indira Branch: IT

Year / Sem: 2 / 3rd sem

4. Name of the Training: Aptitude

5. Name of the Trainer: Mr. S. Vijayaraj

6. Students rating of Trainers :

S. No.	Date	Subject	Rating (√)			
			Excellent	Very good	Good	Average
1	14/06/2018	Maths	✓			

4. Two positive points about the programme:

After explaining work out of sums is useful, and concepts

5. Suggestions for improvement:

are easy understood by solving some problems

Date: 14-06-2018

Dracemathi Indira
Signature
K. S. R. INSTITUTE FOR ENGINEERING AND TECHNOLOGY,
K. S. R. KALVI NAGAR,
TIRUCHENGODE-637 215
NAMAKKAL Dt, TAMIL NADU.

TRAINING PROGRAMME FEEDBACK FORM

Name of the Student: S. BALAJI

Branch: MECH - A

Year / Sem: 2nd - 3rd sem

1. Name of the Training: BASIC PROGRAMMING SKILLS IN C.

2. Name of the Trainer: PRAKASANT

3. Students rating of Trainers :

S. No.	Date	Subject	Rating (✓)			
			Excellent	Very good	Good	Average
1	14.06.18 14.06.18		✓			

4. Two positive points about the programme:

* Very useful & I more learnt about c programming

5. Suggestions for improvement:

We want more class for programming in system.

Date: 14.06.2018.

S. Balaji
Signature

TRAINING PROGRAMME FEEDBACK FORM

Name of the Student: C.M. DHARSHAN

Branch: MECH - A

Year / Sem: 2nd yr - 3rd sem.

4. Name of the Training: BASIC PROGRAMMING SKILLS IN C.

5. Name of the Trainer: PRAKASANT.

6. Students rating of Trainers :

S. No.	Date	Subject	Rating (✓)			
			Excellent	Very good	Good	Average
1	<u>14-06-18</u>		✓			

4. Two positive points about the programme:

Very useful, I learnt more about c program

5. Suggestions for improvement:

We want more class for programming in laboratory.

Date: 14-06-2018

PRINCIPAL
K. S. R. INSTITUTE FOR
ENGINEERING AND TECHNOLOGY,
K. S. R. KAVI NAGAR,
TIRUCHENGODE-637 215,
NAMAKKAL Dt, TAMIL NADU.

Signature

C.M. Dharshan



Name of the Student: MUNEESWARAN D

Branch: BE / MECHANICAL

Year / Sem: II / III

1. Name of the Training: Communication Skill

2. Name of the Trainer: Mugurtharaj

3. Students rating of Trainers :

S. No.	Date	Subject	Rating (√)			
			Excellent	Very good	Good	Average
1	18/06/18(FW)	Communication		✓		

4. Two positive points about the programme:

- 1) Given more knowledge about communication English.
- 2) To know how to speak simple English.

5. Suggestions for improvement:

NIL.

Date: 18/06/18.

Signature

[Signature]



Name of the Student: M. Monish Kanna

Branch: B.E / MECH.

Year / Sem: 2nd / 3rd

4. Name of the Training: placement training

5. Name of the Trainer: C. Mugurtharajan.

6. Students rating of Trainers :

S. No.	Date	Subject	Rating (√)			
			Excellent	Very good	Good	Average
1	18.06.18/AN	Communication English	✓			

4. Two positive points about the programme:

- * developed English knowledge
- * Sir tells very interesting points and facts It is useful for me.

5. Suggestions for improvement:

NIL.

Date: 18.06.2018.

K. S. R. INSTITUTE FOR
ENGINEERING AND TECHNOLOGY,
K. S. R. KALVI NAGAR,
TIRUCHENGODE-637 215,
NAMAKKAL DISTRICT, TAMIL NADU.

Signature

**K S R INSTITUTE FOR ENGINEERING AND TECHNOLOGY
TIRUCHENGODE - 637 215**

TRAINING PROGRAMME FEEDBACK FORM



Name of the Student: N. MOHANAPREYA

Branch: B.E - CSE

Year / Sem: I / III

1. Name of the Training: C Programming

2. Name of the Trainer: N. Sharmila

3. Students rating of Trainers :

S. No.	Date	Subject	Rating (√)			
			Excellent	Very good	Good	Average
1	12.6.18	C Programming	✓			

4. Two positive points about the programme: Can able to learn the C Programming in detail.

Can able to review and getting thorough in the Language

5. Suggestions for improvement:

Extend the classes for one more day.

Date: 12.6.18

N. Mohanapreya
Signature

**K S R INSTITUTE FOR ENGINEERING AND TECHNOLOGY
TIRUCHENGODE - 637 215**

TRAINING PROGRAMME FEEDBACK FORM



Name of the Student: ARUNKUMAR N

Branch: B.E. CSE

Year / Sem: II / 03

4. Name of the Training: C Programming

5. Name of the Trainer: N. Sharmila

6. Students rating of Trainers :

S. No.	Date	Subject	Rating (√)			
			Excellent	Very good	Good	Average
1	12.6.18	C programming			✓	

4. Two positive points about the programme:

To get clear idea about the logic of the program

5. Suggestions for improvement:

Want next level programming teaching

Date: 12.6.18

Want next level in programs.

PRINCIPAL,
K. S. R. INSTITUTE FOR
ENGINEERING AND TECHNOLOGY,
K. P. KRISHNAVI NAGAR,
TIRUCHENGODE-637 215,
NAMAKKAL DISTRICT, TAMIL NADU.

P. D. S.
Signature

TRAINING PROGRAMME FEEDBACK FORM

Name of the Student: R. Senthosh Kumar

Branch: B.TECH-IT

Year / Sem: II yr / III sem

functions
structure

1. Name of the Training: Programming in c

2. Name of the Trainer: Nandagopal

3. Students rating of Trainers :

S. No.	Date	Subject	Rating (√)			
			Excellent	Very good	Good	Average
1	12.06.18	programming in c		✓		

4. Two positive points about the programme: *) we have done most of the programmes
*) level of teaching by staff was good

5. Suggestions for improvement: *) apart from basics, many new and advanced concepts can be taught with practice

R. Senthosh Kumar
Signature

Date: 12.06.18

TRAINING PROGRAMME FEEDBACK FORM

Name of the Student: M. GOBIKA

Branch: IT

Year / Sem: II / III

4. Name of the Training: Programming in c

5. Name of the Trainer: Nandagopal

6. Students rating of Trainers :

S. No.	Date	Subject	Rating (√)			
			Excellent	Very good	Good	Average
1	12.06.18	PROGRAMMING IN C		✓		

4. Two positive points about the programme: In this class, we got the basic ideas about the programming language. Recalling of the basics made us to get clear ideas which is the beginning to our programming skill.

5. Suggestions for improvement:

Exercises to get practised.

Date: 12.06.18

M. Gobika
Signature
K. S. R. KALVI NAGAR,
TIRUCHENGODE-637 215,
NAMAKKAL Dt, TAMIL NADU.

**K S R INSTITUTE FOR ENGINEERING AND TECHNOLOGY
TIRUCHENGODE - 637 215**

TRAINING PROGRAMME FEEDBACK FORM



Name of the Student: ARUN KUMAR S

Branch: B.E - Mech - "A"

Year / Sem: II / 3-sem

1. Name of the Training :

2. Name of the Trainer :

3. Students rating of Trainers :

S. No.	Date	Subject	Rating (✓)			
			Excellent	Very good	Good	Average
1	13.06.2018	CSC	✓			

4. Two positive points about the programme: we have learnt new language
It will help us to improve our programming skills.

5. Suggestions for improvement:

the class can held more in the lab.

S. Arun
Signature

Date:

**K S R INSTITUTE FOR ENGINEERING AND TECHNOLOGY
TIRUCHENGODE - 637 215**

TRAINING PROGRAMME FEEDBACK FORM



Name of the Student: Ajith Kumar R

Branch: B.E - mech - "A"

Year / Sem: II / 3-sem

4. Name of the Training :

5. Name of the Trainer :

6. Students rating of Trainers :

S. No.	Date	Subject	Rating (✓)			
			Excellent	Very good	Good	Average
1	13.06.2018	CSC	✓			

4. Two positive points about the programme: we have learnt new language.
It will help us to improve our programming skills.

5. Suggestions for improvement:

the class can held more in the lab.

K. S. R. INSTITUTE FOR
ENGINEERING AND TECHNOLOGY
K. S. R. KALVI NAGAR,
TIRUCHENGODE-637 215,
NAMAKKAL Dt, TAMIL NADU.

A. Arun
Signature

Date:

K S R INSTITUTE FOR ENGINEERING AND TECHNOLOGY
TIRUCHENGODE - 637 215

TRAINING PROGRAMME FEEDBACK FORM



Name of the Student: C. Mohanaraj

Branch: Mech - R

Year / Sem: II / III

1. Name of the Training: Soft Skills

2. Name of the Trainer: Sathyavriya

3. Students rating of Trainers: 4/5

S. No.	Date	Subject	Rating (√)			
			Excellent	Very good	Good	Average
1	13/6/18	C Programming	✓			

4. Two positive points about the programme:

- i) Good in teaching
- ii) Good communication.

5. Suggestions for improvement:

- i) Applications needed

Date: 13/6/18 - FN

C. Mohanaraj

Signature

K S R INSTITUTE FOR ENGINEERING AND TECHNOLOGY
TIRUCHENGODE - 637 215

TRAINING PROGRAMME FEEDBACK FORM



Name of the Student: R. Saravanan

Branch: Mech - B

Year / Sem: II / IV

4. Name of the Training: Soft Skills

5. Name of the Trainer: Sathyavriya

6. Students rating of Trainers: 4/5

S. No.	Date	Subject	Rating (√)			
			Excellent	Very good	Good	Average
1	13/6/18	C Programming	✓			

4. Two positive points about the programme:

- i) Good in teaching
- ii) Good communication

5. Suggestions for improvement:

- (i) Applications needed.

Date: 13/6/18 - AN

PRINCIPAL,
K. S. R. INSTITUTE FOR
ENGINEERING AND TECHNOLOGY,
K. S. R. KALVI NAGAR,
TIRUCHENGODE-637 215,
NAMAKKAL DI, TAMIL NADU.

[Signature]

Signature



Name of the Student: J.P. Jessica Collins

Branch: B.Tech/IT

Year / Sem: II / III

1. Name of the Training: APS Skill

2. Name of the Trainer: Mr. Vijayaraj Sir

3. Students rating of Trainers :

S. No.	Date	Subject	Rating (✓)			
			Excellent	Very good	Good	Average
1	13.6.18	maths	✓			

TOPIC - Time & work, pipes and cisterns, time, speed distance

4. Two positive points about the programme:
 • Was very easy to cope up with
 • PPT was useful.

5. Suggestions for improvement: -

Date: 13.6.18

Signature J.P.



Name of the Student: R. Dhanush Adit

Branch: B. tech/IT

Year / Sem: II / III

4. Name of the Training: APS skill

5. Name of the Trainer: Mr. Vijayaraj Sir

6. Students rating of Trainers :

S. No.	Date	Subject	Rating (✓)			
			Excellent	Very good	Good	Average
1	13.6.18	maths	✓			

Topic - Time and work, pipes and cisterns, time, speed distance

4. Two positive points about the programme:
 * PPT presentation was very good

5. Suggestions for improvement:
 we want more example

Date: 13.6.18 every each topics

PRINCIPAL.
K. S. R. INSTITUTE FOR
ENGINEERING AND TECHNOLOGY,
K. S. R. KALVI NAGAR,
TIRUCHENGODE-637 215.
NAMAKKAL, Dt, TAMIL NADU.
Signature R. J. hadh

K S R INSTITUTE FOR ENGINEERING AND TECHNOLOGY
TIRUCHENGODE - 637 215

TRAINING PROGRAMME FEEDBACK FORM



Name of the Student: THANESHWARAN.Y.G Branch: IT / IInd Year

Year / Sem: 2nd Year / 3rd Sem

1. Name of the Training: Aptitude Skill training

2. Name of the Trainer: Mr. S. Vijayaraj

3. Students rating of Trainers :

S. No.	Date	Subject	Rating (√)			
			Excellent	Very good	Good	Average
1	14.06.18	Aptitude		✓		

4. Two positive points about the programme:

we learn all the 6 topics

5. Suggestions for improvement:

NO

Thanesk Y.G
Signature

Date: 14, 06, 2018

K S R INSTITUTE FOR ENGINEERING AND TECHNOLOGY
TIRUCHENGODE - 637 215

TRAINING PROGRAMME FEEDBACK FORM



Name of the Student: Sreemathi Indira Branch: IT

Year / Sem: 2 / 3rd sem

4. Name of the Training: Aptitude

5. Name of the Trainer: Mr. S. Vijayaraj

6. Students rating of Trainers :

S. No.	Date	Subject	Rating (√)			
			Excellent	Very good	Good	Average
1	14/06/2018	Aptitude	✓			

4. Two positive points about the programme:

After explaining work out of sums is useful. and concepts

5. Suggestions for improvement:

Some problems
K. S. R. INSTITUTE FOR ENGINEERING AND TECHNOLOGY
K. S. R. KALVI NAGAR,
TIRUCHENGODE-637 215,
NAMAKKAL Dt, TAMIL NADU.

S. Sreemathi Indira
Signature

Date: 14 06 - 2018



Name of the Student: S. BALAJI

Branch: MECH - A

Year / Sem: 2nd - 3rd sem

1. Name of the Training: BASIC PROGRAMMING SKILLS IN C.

2. Name of the Trainer: PRAKASAM

3. Students rating of Trainers :

S. No.	Date	Subject	Rating (√)			
			Excellent	Very good	Good	Average
1	14.06.18 14.06.18		✓			

4. Two positive points about the programme:

* Very useful & I more learnt about c programming

5. Suggestions for improvement:

We want more class for programming in system.

Date: 14.06.2018.

S. Balaji
Signature



Name of the Student: C.M. DHARSHAN

Branch: MECH - A

Year / Sem: 2nd yr - 3rd sem.

4. Name of the Training: BASIC PROGRAMMING SKILLS IN C.

5. Name of the Trainer: PRAKASAM.

6. Students rating of Trainers :

S. No.	Date	Subject	Rating (√)			
			Excellent	Very good	Good	Average
1	<u>14-06-18</u>		✓			

4. Two positive points about the programme:

Very useful, I learnt more about c program

5. Suggestions for improvement:

We want more class for programming in laborator

Date: 14-06-2018

Signature

C.M. Dharshan



Name of the Student: MUNEESWARAN. D

Branch: RE / MECHANICAL

Year / Sem: II / III

1. Name of the Training : Communication Skill

2. Name of the Trainer : Mugurtharaj

3. Students rating of Trainers :

S. No.	Date	Subject	Rating (✓)			
			Excellent	Very good	Good	Average
1	18/06/18	Communication		✓		

4. Two positive points about the programme:

- 1) Given more knowledge about communication English
- 2) To know how to speak simple English

5. Suggestions for improvement:

NIL.

Date: 18/06/18

Signature
[Signature]



Name of the Student: M. Monish Kanna

Branch: B.E / MECH.

Year / Sem: 2nd / 3rd

4. Name of the Training : placement training

5. Name of the Trainer : C. Mugurtharaj

6. Students rating of Trainers :

S. No.	Date	Subject	Rating (✓)			
			Excellent	Very good	Good	Average
1	18.06.18/A.N	Communication English	✓			

4. Two positive points about the programme:

- * developed English knowledge.
- * Sir tells very interesting points and facts It is useful

5. Suggestions for improvement:

NIL.

Date: 18.06.2018

PRINCIPAL.
K. S. R. INSTITUTE FOR
ENGINEERING AND TECHNOLOGY,
K. S. R. KALVI NAGAR,
TIRUCHENGODE-637 215,
NAMAKKAL DI, TAMIL NADU.

Signature
[Signature]

**K S R INSTITUTE FOR ENGINEERING AND TECHNOLOGY
TIRUCHENGODE - 637 215**

TRAINING PROGRAMME FEEDBACK FORM



Name of the Student: J. Ruban Prasad

Branch: ECE

Year / Sem: II yr / 2

1. Name of the Training: C programming

2. Name of the Trainer: LAVANYA

3. Students rating of Trainers :

S. No.	Date	Subject	Rating (√)			
			Excellent	Very good	Good	Average
1	18/6/18	C programming		✓		

4. Two positive points about the programme: Very Usefull
Good teaching

5. Suggestions for improvement:

Nil

Date: 18/6/18

Signature

**K S R INSTITUTE FOR ENGINEERING AND TECHNOLOGY
TIRUCHENGODE - 637 215**

TRAINING PROGRAMME FEEDBACK FORM



Name of the Student: S. Ramya

Branch: ECE

Year / Sem: II / 02

4. Name of the Training: c programming

5. Name of the Trainer: Lavanya

6. Students rating of Trainers :

S. No.	Date	Subject	Rating (√)			
			Excellent	Very good	Good	Average
1	18.6.18	c programming			✓	

4. Two positive points about the programme: 1) Good conveying to students
2) very useful

5. Suggestions for improvement: Nil

K. S. R. INSTITUTE FOR
ENGINEERING AND TECHNOLOGY,
K. S. R. KALVI NAGAR,
TIRUCHENGODE-637 215,
NAMAKKAL DISTRICT, TAMIL NADU.

Date: 18.6.18

Signature

K S R INSTITUTE FOR ENGINEERING AND TECHNOLOGY
TIRUCHENGODE - 637 215

TRAINING PROGRAMME FEEDBACK FORM



Name of the Student: Gnanatham, M. Branch: ECE - A

Year / Sem: II / III

1. Name of the Training: Programming in C.
 2. Name of the Trainer: Bala Krishnan.
 3. Students rating of Trainers: 8/10.

S. No.	Date	Subject	Rating (√)			
			Excellent	Very good	Good	Average
1	18.6.18	Programming in C.		✓		

4. Two positive points about the programme:
 * He is so friendly
 * His teaching is understood by me.

5. Suggestions for improvement:
 * To Repeat some difficulties.

Date: _____ Signature: _____

K S R INSTITUTE FOR ENGINEERING AND TECHNOLOGY
TIRUCHENGODE - 637 215

TRAINING PROGRAMME FEEDBACK FORM



Name of the Student: S. Hemalatha Branch: BCE - A

Year / Sem: II / III

4. Name of the Training: Programming in C
 5. Name of the Trainer: Balakrishnan
 6. Students rating of Trainers: 8.5/10

S. No.	Date	Subject	Rating (√)			
			Excellent	Very good	Good	Average
1	18.6.18	Programming in C		✓		

4. Two positive points about the programme:
 * His teaching was understood by all.
 * His coaching in lab was excellent.

5. Suggestions for improvement:
 * Explanation of program has to be improved.

Date: _____ Signature: _____
 PRINCIPAL,
 K. S. R. INSTITUTE FOR
 ENGINEERING AND TECHNOLOGY,
 K. S. R. KALVI NAGAR,
 TIRUCHENGODE-637 215
 NAMAKKAL DI, TAMIL NADU.



Name of the Student: T. Janani Branch: IT

Year / Sem: III/05

1. Name of the Training : Industrial Readiness program

2. Name of the Trainer : Dr. Nandhakumar

3. Students rating of Trainers :

S. No.	Date	Subject	Rating (✓)			
			Excellent	Very good	Good	Average
1	19.06.18	Training program	✓			

4. Two positive points about the programme: 1) very motivational
2) Interactive session

5. Suggestions for improvement: NIL

Date: 20/6/18

[Signature]
Signature



Name of the Student: J. Kowsalya Branch: IT

Year / Sem: III/05

4. Name of the Training : Industrial Readiness Program

5. Name of the Trainer : Dr. Nandhakumar

6. Students rating of Trainers :

S. No.	Date	Subject	Rating (✓)			
			Excellent	Very good	Good	Average
1	19.6.18	Training Program	✓			

4. Two positive points about the programme: 1) We learn lot about our career.
2) Motivational talk.

5. Suggestions for improvement: NIL

Date: 20/6/18

[Signature]
PRINCIPAL,
K S R INSTITUTE FOR
ENGINEERING AND TECHNOLOGY,
K. S. R. KALVI NAGAR,
TIRUCHENGODE-637 215,
NAMAKKAL Dt, TAMIL NADU,

Signature

**K S R INSTITUTE FOR ENGINEERING AND TECHNOLOGY
TIRUCHENGODE – 637 215**

TRAINING PROGRAMME FEEDBACK FORM



Name of the Student: S.S. NAVEEN Branch: ECE

Year / Sem: II yr / 3

1.Name of the Training : C programming

2.Name of the Trainer : LAVANYA

3.Students rating of Trainers : 9/10

S. No.	Date	Subject	Rating (√)			
			Excellent	Very good	Good	Average
1	19/6/18	C programming		✓		

4. Two positive points about the programme: (i) Method of teaching is Nice
(ii) Problem Solving Methodology is easy

5. Suggestions for improvement:

Nil

Date: 19/6/18

[Signature]
Signature

**K S R INSTITUTE FOR ENGINEERING AND TECHNOLOGY
TIRUCHENGODE – 637 215**

TRAINING PROGRAMME FEEDBACK FORM



Name of the Student: Priga R Branch: FCE

Year / Sem: II yr / 3

4.Name of the Training : C Programming

5.Name of the Trainer : LAVANYA

6.Students rating of Trainers : 9/10

S. No.	Date	Subject	Rating (√)			
			Excellent	Very good	Good	Average
1	19/6/18	C Programming		✓		

4. Two positive points about the programme: (i) Explanation of Program is nice
(ii) Programs were made simple.

5. Suggestions for improvement:

Nil

Date: 19/6/18

K. S. R. INSTITUTE FOR
ENGINEERING AND TECHNOLOGY,
K. S. R. KALVI NAGAR,
TIRUCHENGODE-637 215,
NAMAKKAL Dt, TAMIL NADU.

[Signature]
Signature



Name of the Student: P. Sakthivel

Branch: BE - EEE

Year / Sem: II / III

4. Name of the Training: Vijaya Raj

5. Name of the Trainer:

6. Students rating of Trainers:

S. No.	Date	Subject	Rating (√)			
			Excellent	Very good	Good	Average
1	25.6.2018	maths aptitude		✓		

4. Two positive points about the programme: Good and interest

5. Suggestions for improvement: Need more explanation

Date: 25.6.2018

P. Sakthivel
Signature



Name of the Student: P. Ramya

Branch: B. E, FEE

Year / Sem: 2018/3rd

1. Name of the Training: aptitude Test

2. Name of the Trainer: Vijaya Raj

3. Students rating of Trainers:

S. No.	Date	Subject	Rating (√)			
			Excellent	Very good	Good	Average
1	25/6/18	aptitude.	✓			

4. Two positive points about the programme: Very Useful for placement training

5. Suggestions for improvement:

**K S R INSTITUTE FOR ENGINEERING AND TECHNOLOGY
TIRUCHENGODE - 637 215**

TRAINING PROGRAMME FEEDBACK FORM



Name of the Student: S. Hemalatha

Branch: ECE - A

Year / Sem: II / III

1. Name of the Training : Programming in C

2. Name of the Trainer : Balakerishnan

3. Students rating of Trainers : 8 / 10

S. No.	Date	Subject	Rating (√)			
			Excellent	Very good	Good	Average
1	19/6/18			✓		

4. Two positive points about the programme:

* His teaching was very good

* Understanding level of students was nice

5. Suggestions for improvement:

Teaching programming in C has to be improved.

Date: 19/6/18

S. Hemalatha
Signature

**K S R INSTITUTE FOR ENGINEERING AND TECHNOLOGY
TIRUCHENGODE - 637 215**

TRAINING PROGRAMME FEEDBACK FORM



Name of the Student: G. Geetha Rani

Branch: ECE - A

Year / Sem: II / III

4. Name of the Training : Programming in C

5. Name of the Trainer : Balakerishnan

6. Students rating of Trainers : 8.5 / 10

S. No.	Date	Subject	Rating (√)			
			Excellent	Very good	Good	Average
1	19/6/18				✓	

4. Two positive points about the programme:

* His teaching was good

* Way of approaching was nice

5. Suggestions for improvement:

Explanation of

Date: 19/6/18

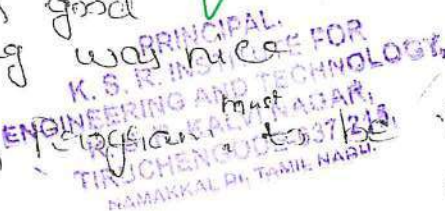

improved
G. Geetha Rani
Signature

K S R INSTITUTE FOR ENGINEERING AND TECHNOLOGY
TIRUCHENGODE - 637 215

TRAINING PROGRAMME FEEDBACK FORM



Name of the Student: M. Kavi raj

Branch: MECH

Year / Sem: II / 03

1. Name of the Training : Maths
2. Name of the Trainer : vijayaraj
3. Students rating of Trainers :

S. No.	Date	Subject	Rating (√)			
			Excellent	Very good	Good	Average
1	19.06.18	Maths	✓			

4. Two positive points about the programme:

content delivery very nice
easily understand.

5. Suggestions for improvement:

NO suggestion.

Date: 19.06.18

M. Kavi Raj
Signature

K S R INSTITUTE FOR ENGINEERING AND TECHNOLOGY
TIRUCHENGODE - 637 215

TRAINING PROGRAMME FEEDBACK FORM



Name of the Student: Kirubakaran.K.

Branch: MECH

Year / Sem: II / 03

4. Name of the Training : Maths
5. Name of the Trainer : vijayaraj
6. Students rating of Trainers :

S. No.	Date	Subject	Rating (√)			
			Excellent	Very good	Good	Average
1	19.06.18	Maths		✓		

4. Two positive points about the programme:

Smart class
very useful
easily understand.

5. Suggestions for improvement:

No suggestions

PRINCIPAL,
K. S. R. INSTITUTE FOR
ENGINEERING AND TECHNOLOGY,
K. S. R. KALVI NAGAR,
TIRUCHENGODE-637 215,
NAMAKKAL Dt. TAMIL NADU.

Date: 19.06.2018

Kirubakaran.K.
Signature



Name of the Student: VINOTHICUMAR . T

Branch: MECH ' B'

Year / Sem: I / III

1.Name of the Training : Placement Training

2.Name of the Trainer : Mukuntharajan

3.Students rating of Trainers :

S. No.	Date	Subject	Rating (√)			
			Excellent	Very good	Good	Average
1	20/06/18 FN	Communication English	✓			

4. Two positive points about the programme:

- * I develop the speaking knowledge.
- * AND speak well.

5. Suggestions for improvement:

- * weekly once need this type of program.

Date: 20/06/18.

J. Prudhvi
Signature



Name of the Student: NAPESH.

Branch: MECHANICAL

Year / Sem: II / III

4.Name of the Training : Communication

5.Name of the Trainer : Mutharajan . C

6.Students rating of Trainers :

S. No.	Date	Subject	Rating (√)			
			Excellent	Very good	Good	Average
1	20.6.2018 AN	Communication english	✓			

4. Two positive points about the programme:

- * Too good to improve my knowledge.
- * Best experience with teaching skills.

5. Suggestions for improvement:

- should be made by performed trainer

Date: 20.06-2018

[Signature]
PRINCIPAL,
K. S. R. INSTITUTE FOR
ENGINEERING AND TECHNOLOGY,
K. S. R. KALVI NAGAR, Signature
TIRUCHENGODE-637 215,
NAMAKKAL DL, TAMIL NADU.



Name of the Student: G. Kamalahasan Branch: EEE

Year / Sem: II / III

1. Name of the Training: BASIC COMMUNICATION SKILL

2. Name of the Trainer: C. ~~MUNTHARAJAN~~ MUHUNTHARAJAN

3. Students rating of Trainers :

S. No.	Date	Subject	Rating (✓)			
			Excellent	Very good	Good	Average
1	21-6-18	ENGLISH	✓			

4. Two positive points about the programme: i) Basic communication is learned.
ii) We have form a team.

5. Suggestions for improvement:

Nothing

G. Kamalahasan
Signature

Date: 21-6-18



Name of the Student: R. ASHA Branch: B- E EEE

Year / Sem: II / III

4. Name of the Training: Basic Communication Skills.

5. Name of the Trainer: Dr. C. Muhuntharajan.

6. Students rating of Trainers :

S. No.	Date	Subject	Rating (✓)			
			Excellent	Very good	Good	Average
1	21-6-18	Listening Skills, speaking.	✓			

4. Two positive points about the programme: i) Make Everyone to share their ideas in simple English.
ii) Encouraged students to speak English.

5. Suggestions for improvement:

More Interactions.

Asharaj
Signature

Date: 21-6-18



Name of the Student: N. MOHANAPREYF

Branch: B.E - CSE

Year / Sem: II (II)

1. Name of the Training : APTITUDE TRAINING

2. Name of the Trainer : M.S. VISAYARAJ

3. Students rating of Trainers :

S. No.	Date	Subject	Rating (✓)			
			Excellent	Very good	Good	Average
1	21.6.18	aptitude training	✓			

4. Two positive points about the programme:

able to learn many different topics

5. Suggestions for improvement:

getting thorough in the topics helps to gain knowledge.

Extend the class for one more day

Date: 21.6.18

N. Mohanofj.
Signature



Name of the Student: J. Deepak Kumar

Branch: CSE

Year / Sem: II (II)

4. Name of the Training : APTITUDE TRAINING

5. Name of the Trainer : Ms. Vijayaraj

6. Students rating of Trainers : Good

S. No.	Date	Subject	Rating (✓)			
			Excellent	Very good	Good	Average
1	21.6.18	Maths			✓	

4. Two positive points about the programme:

Thinking and calculating

5. Suggestions for improvement:

Clear and good speech

Date: 21.6.18

PRINCIPAL
K. S. R. INSTITUTE FOR
ENGINEERING AND TECHNOLOGY
K. S. R. KALVI NAGAR,
TIRUCHENGODE-637 215,
NAMAKKAL DI, TAMIL NADU.

J. Deepak
Signature

TIRUCHENGODE - 637 215
 TRAINING PROGRAMME FEEDBACK FORM



Name of the Student: A. RAMYA Branch: RE EEE

Year / Sem: 2nd Year - 3rd Sem

1. Name of the Training: communication skill

2. Name of the Trainer :

3. Students rating of Trainers :

S. No.	Date	Subject	Rating (✓)			
			Excellent	Very good	Good	Average
1	22-06-2018	English	✓			

4. Two positive points about the programme:

* It is very interesting and learn more
 *

5. Suggestions for improvement:

I try to talk to speak in english here
 Signature A. Ramya

Date: 22-06-2018

K S R INSTITUTE FOR ENGINEERING AND TECHNOLOGY
 TIRUCHENGODE - 637 215
 TRAINING PROGRAMME FEEDBACK FORM



Name of the Student: K. Karim muthu Kumar Branch: RE EEE

Year / Sem: II / III

4. Name of the Training: Basic communication skills

5. Name of the Trainer: M. Muthuvarjan

6. Students rating of Trainers :

S. No.	Date	Subject	Rating (✓)			
			Excellent	Very good	Good	Average
1	22.06.18	English	✓			

4. Two positive points about the programme:

* It is very useful.
 * It is very interesting.

5. Suggestions for improvement:

The duration of the program ✓

Date: is less. it should be increased

22-06-18

Signature [Handwritten Signature]

PRINCIPAL
 K. S. R. INSTITUTE FOR
 ENGINEERING AND TECHNOLOGY,
 K. S. R. KALVI NAGAR,
 TIRUCHENGODE-637 215,
 NAMAKKAL DI, TAMIL NADU.

TIRUCHENGODE - 637 215
TRAINING PROGRAMME FEEDBACK FORM



Name of the Student: M. Gobiika

Branch: IT/B. Tech

Year / Sem: I / 03

1. Name of the Training : COMMUNICATIVE SKILLS

2. Name of the Trainer : MUGUNTHARAJAN - C

3. Students rating of Trainers :

S. No.	Date	Subject	Rating (✓)			
			Excellent	Very good	Good	Average
1	25.06.18	ENGLISH		✓		

4. Two positive points about the programme: The training was entirely useful to make us strong in the communication side. New innovative thoughts and ideas was gained.

5. Suggestions for improvement:

The training was entirely good and these are no more suggestions.

Date: 25.06.18

[Signature]
Signature

K S R INSTITUTE FOR ENGINEERING AND TECHNOLOGY
TIRUCHENGODE - 637 215
TRAINING PROGRAMME FEEDBACK FORM



Name of the Student: G. Mounish

Branch: B-Tech /IT

Year / Sem: I / 03

4. Name of the Training : COMMUNICATIVE SKILLS

5. Name of the Trainer : MUGUNTHARAJAN - C

6. Students rating of Trainers :

S. No.	Date	Subject	Rating (✓)			
			Excellent	Very good	Good	Average
1	25.06.18	English	✓			

4. Two positive points about the programme: The training was very effective to learn so many things

5. Suggestions for improvement: Maintain the same improvement on tomorrow.

Date: 25-06-18.

[Signature]
Signature

PRINCIPAL.
K. S. R. INSTITUTE FOR
ENGINEERING AND TECHNOLOGY,
K. S. R. KALVI NAGAR,
TIRUCHENGODE-637 215,
NAMAKKAL Dt, TAMIL NADU.

TIRUCHENGODE - 637 215
TRAINING PROGRAMME FEEDBACK FORM



Name of the Student: Lakshmanan

Branch: B.Tech IT

Year / Sem: II / III

1. Name of the Training: Dr. Muguntharaj Communication skill

2. Name of the Trainer: Dr. C. Muguntharaj

3. Students rating of Trainers :

S. No.	Date	Subject	Rating (✓)			
			Excellent	Very good	Good	Average
1	26.06.18	communication skill	✓			

4. Two positive points about the programme: Sir taught to us, how to improve our communication skills in multi way. Sir, gave us lot and lot of activity to improve communication, these sir gave to us are very good...

5. Suggestions for improvement:

No suggestions.

Date:

Sir taught us in good way.

D. Laksh
Signature

K S R INSTITUTE FOR ENGINEERING AND TECHNOLOGY
TIRUCHENGODE - 637 215
TRAINING PROGRAMME FEEDBACK FORM



Name of the Student: Gobika M.

Branch: B.Tech /IT

Year / Sem: II / III

4. Name of the Training: communicative skill

5. Name of the Trainer: Dr. C. Muguntharaj

6. Students rating of Trainers :

S. No.	Date	Subject	Rating (✓)			
			Excellent	Very good	Good	Average
1	26.06.18	communicative skill	✓			

4. Two positive points about the programme: The training brought us many innovative thinkings to improve the communicative skills. Many activities that gave us enough stuff to improve ourself.

5. Suggestions for improvement:

I hope the training was more over good

Date: 26.06.18

PRINCIPAL,
K. S. R. INSTITUTE FOR
ENGINEERING AND TECHNOLOGY,
K. S. R. KALVI NAGAR,
TIRUCHENGODE-637 215,
NAMAKKAL DI. TAMIL NADU.

N. Gobika
Signature

K S R INSTITUTE FOR ENGINEERING AND TECHNOLOGY
TIRUCHENGODE - 637 215
TRAINING PROGRAMME FEEDBACK FORM



Name of the Student: S. HEMALATHA

Branch: B.E - EEE

Year / Sem: II / III

1. Name of the Training: Basic Aptitude Skill

2. Name of the Trainer: Vijayaraj

3. Students rating of Trainers :

S. No.	Date	Subject	Rating (✓)			
			Excellent	Very good	Good	Average
1	26-06-18	Basic Aptitude Skill		✓		

4. Two positive points about the programme: We are allowed to solve the problems

5. Suggestions for improvement: Give more problems to improve our skills

Date: 26-06-18

[Signature]
Signature

K S R INSTITUTE FOR ENGINEERING AND TECHNOLOGY
TIRUCHENGODE - 637 215
TRAINING PROGRAMME FEEDBACK FORM



Name of the Student: S. Kavin Muthu Kumar

Branch: B.E

Year / Sem: II / III

4. Name of the Training: Basic Aptitude skills.

5. Name of the Trainer: Vijayaraj

6. Students rating of Trainers :

S. No.	Date	Subject	Rating (✓)			
			Excellent	Very good	Good	Average
1	26-06-18	Basic Aptitude Skill	✓			

4. Two positive points about the programme: It is interesting.

It is easy to understand.

5. Suggestions for improvement:

Time is insufficient.

Date: 26-06-18

[Signature]

Signature

PRINCIPAL,
K. S. R. INSTITUTE FOR
ENGINEERING AND TECHNOLOGY,
K. S. R. KALVI NAGAR,
TIRUCHENGODE-637 215,
NAMAKKAL DI, TAMIL NADU.

**K S R INSTITUTE FOR ENGINEERING AND TECHNOLOGY
TIRUCHENGODE – 637 215**

TRAINING PROGRAMME FEEDBACK FORM



Name of the Student: Kishor - M

Branch: ECE

Year / Sem: II / III
A

1.Name of the Training : Communication Skills

2.Name of the Trainer : C. Muthurajan

3.Students rating of Trainers : 9/10

S. No.	Date	Subject	Rating (√)			
			Excellent	Very good	Good	Average
1	28.6.18	Communication Skills	✓			

4. Two positive points about the programme:
 - Essential for Interview
 - Understandable

5. Suggestions for improvement:

Date: 28.6.18

Kishor M

Signature

**K S R INSTITUTE FOR ENGINEERING AND TECHNOLOGY
TIRUCHENGODE – 637 215**

TRAINING PROGRAMME FEEDBACK FORM



Name of the Student: Hemalatha S

Branch: ECE

Year / Sem: II / III
A

4.Name of the Training : Communication skills

5.Name of the Trainer : C. Muthurajan

6.Students rating of Trainers : 9.5/10

S. No.	Date	Subject	Rating (√)			
			Excellent	Very good	Good	Average
1	28.6.18	Communication Skills	✓			

4. Two positive points about the programme: - Useful

5. Suggestions for improvement:

Date: 28.6.18

PRINCIPAL.
K. S. R. INSTITUTE FOR
ENGINEERING AND TECHNOLOGY,
K. S. R. KALVI NAGAR,
TIRUCHENGODE-637 215,
NAMAKKAL DI, TAMIL NADU.

Hemalatha S

Signature



Name of the Student: SUKHESANE Branch: ECE

Year / Sem: II / III

1. Name of the Training: APTITUDE

2. Name of the Trainer: VIJAYARAJ

3. Students rating of Trainers :

S. No.	Date	Subject	Rating (✓)			
			Excellent	Very good	Good	Average
1	28.06.18	APTITUDE		✓		

4. Two positive points about the programme: I have improved my Aptitude knowledge.

5. Suggestions for improvement: No.

Date: 28.08.18

[Signature]
Signature



Name of the Student: V. Raghu Ramachandran Branch: ECE

Year / Sem: II - III Sem

4. Name of the Training: APTITUDE

5. Name of the Trainer: Vijayaraj

6. Students rating of Trainers :

S. No.	Date	Subject	Rating (✓)			
			Excellent	Very good	Good	Average
1	28.06.18	Aptitude		✓		

4. Two positive points about the programme: It is used to solve the problem easily.

5. Suggestions for improvement: No

Date: 28.08.18

PRINCIPAL
K. S. R. INSTITUTE FOR
ENGINEERING AND TECHNOLOGY,
K. S. R. KALVI NAGAR,
TIRUCHENGODE-637 215,
NAMAKKAL Dt, TAMIL NADU.

[Signature]
Signature



Name of the Student: R. Priya Branch: ECE

Year / Sem: V / III

1. Name of the Training : Aptitude

2. Name of the Trainer : Vijayaraj

3. Students rating of Trainers : 10/10

S. No.	Date	Subject	Rating (√)			
			Excellent	Very good	Good	Average
1	29/06/18	Aptitude		✓		

4. Two positive points about the programme:

Easy to solve the Problem

5. Suggestions for improvement:

NIL

Date: 29/06/18

R. Priya
Signature



Name of the Student: SINDHUTA Branch: ECE

Year / Sem: V / III

4. Name of the Training : Aptitude

5. Name of the Trainer : Vijayaraj

6. Students rating of Trainers :

S. No.	Date	Subject	Rating (√)			
			Excellent	Very good	Good	Average
1	29/06/18	Aptitude		✓		

4. Two positive points about the programme:

We are able to do problems shortly and easily and it improved logical thinking.

5. Suggestions for improvement:

NIL

Date: 29/6/18

PRINCIPAL,
K. S. R. INSTITUTE FOR
ENGINEERING AND TECHNOLOGY,
K. S. R. KALVI NAGAR, Signature Sindhuta
TIRUCHENGODE-637 215,
NAMAKKAL Dt, TAMIL NADU.



Name of the Student: R. Hari Hara Sudhan

Branch: ECET-A

Year / Sem: 2nd / 3rd

1. Name of the Training: COMMUNICATION SKILLS

2. Name of the Trainer: C. MUHUNTHARAJAN

3. Students rating of Trainers: 10

S. No.	Date	Subject	Rating (✓)			
			Excellent	Very good	Good	Average
1	29/8/2018	COMMUNICATION SKILLS	✓			

4. Two positive points about the programme:

His class can't bore

His class is useful for remove our stage fear

5. Suggestions for improvement:

Date: 29/8/2018

R. Hari Hara Sudhan
Signature



Name of the Student: N. DHANUSHKODI

Branch: ECET - A

Year / Sem: 2nd / 3rd

4. Name of the Training: C. MUHUNTHARAJAN

5. Name of the Trainer: Communication skills

6. Students rating of Trainers: 10

S. No.	Date	Subject	Rating (✓)			
			Excellent	Very good	Good	Average
1	29/6/18	Communication skills	✓			

4. Two positive points about the programme:

* our class was so Excitement.

* It is useful for placement

5. Suggestions for improvement:

Date: 29/6/18

PRINCIPAL,
K. S. R. INSTITUTE FOR
ENGINEERING AND TECHNOLOGY,
K. S. R. KALVI NAGAR,
TIRUCHENGODE-637 215,
NAMAKKAL DI, TAMIL NADU.

N. 2
Signature



Name of the Student: F. Arun Kumar Branch: Mech - A.

Year / Sem: II Year / II sem.

4. Name of the Training : Placement training [English].

5. Name of the Trainer : C. Muguntharajan

6. Students rating of Trainers :

S. No.	Date	Subject	Rating (✓)			
			Excellent	Very good	Good	Average
1	3.7.18	English	✓			

4. Two positive points about the programme: *) To learn communicative skills.

*) To learn more general knowledge

5. Suggestions for improvement:

Date: 3.7.18

Signature

F. Arun Kumar



Name of the Student: R. Govindharasan Branch: Mechanical.

Year / Sem: II years / II sem

1. Name of the Training : placement training (english)

2. Name of the Trainer : muguntharajan

3. Students rating of Trainers :

S. No.	Date	Subject	Rating (✓)			
			Excellent	Very good	Good	Average
1	3.7.18	English	✓			

PRINCIPAL.

4. Two positive points about the programme: INSTITUTE FOR
1) Visual to see ENGINEERING AND TECHNOLOGY,

(ii) Improve the knowledge
K. S. R. KALVINAGAR,
TIRUCHENGODE - 637 215,

5. Suggestions for improvement:

NAMAKKAL DI, TAMIL NADU.

*

Date: 2.7.18

R. Govindharasan
Signature



Name of the Student: NAVEEN. V

Branch: MECHANICAL

Year / Sem: I Year, II sec.

1. Name of the Training: APTITUDE

2. Name of the Trainer: Vi Jayarajan

3. Students rating of Trainers :

S. No.	Date	Subject	Rating (√)			
			Excellent	Very good	Good	Average
1	3/7/18	APTITUDE			✓	

4. Two positive points about the programme:

- * It was very useful.
- * The problem learn learn easily

5. Suggestions for improvement:

- * Give some activity at the centre of class

Date: 3/7/18

Naveen V
Signature



Name of the Student: PRAGIATHEESWAR.E

Branch: MECHANICAL

Year / Sem: II - Year, III sec

4. Name of the Training: APTITUDE

5. Name of the Trainer: Vi Jayarajan

6. Students rating of Trainers :

S. No.	Date	Subject	Rating (√)			
			Excellent	Very good	Good	Average
1	3/7/18	APTITUDE	✓			

4. Two positive points about the programme:

- * It is very useful to develop our knowledge
- * It is very interesting to listen

5. Suggestions for improvement:

- * There is no suggestions for my side.

Date:

Pr
PRINCIPAL,
K. S. R. INSTITUTE FOR
ENGINEERING AND TECHNOLOGY,
K. S. R. KALVI NAGAR,
TIRUCHENGODE-637 215,
NAMAKKAL DI, TAMIL NADU.

Pr
Signature



Name of the Student: P. SURENDHAR

Branch: Mech-B

Year / Sem: 2nd / 3 sem

1. Name of the Training: APTITUDE

2. Name of the Trainer: Vijayaraj

3. Students rating of Trainers :

S. No.	Date	Subject	Rating (√)			
			Excellent	Very good	Good	Average
1	4.7.2018	APTITUDE		✓		

4. Two positive points about the programme: Improve the analysing problems, to improve present of mid.

5. Suggestions for improvement: Nil

Date: 4.7.2018

P. SURENDHAR
Signature



Name of the Student: M. NAVEEN

Branch: Mech-B

Year / Sem: 2nd / 3 sem

4. Name of the Training: APTITUDE

5. Name of the Trainer: Vijayarajan

6. Students rating of Trainers :

S. No.	Date	Subject	Rating (√)			
			Excellent	Very good	Good	Average
1	4.7.2018	APTITUDE			✓	

4. Two positive points about the programme: Improve the maths sum

5. Suggestions for improvement: Nil

Date: 4.7.16

PRINCIPAL,
K. S. R. INSTITUTE FOR
ENGINEERING AND TECHNOLOGY,
K. S. R. KALVI NAGAR,
TIRUCHENGODE-637 215,
NAMAKKAL DISTRICT, TAMIL NADU.

M. NAVEEN
Signature



Name of the Student: S. TEJASWINI Branch: ECE

Year / Sem: IInd - IIIrd

1. Name of the Training: BASIC COMMUNICATION SKILL

2. Name of the Trainer: MUKUNTHRAJAN

3. Students rating of Trainers: 10

S. No.	Date	Subject	Rating (✓)			
			Excellent	Very good	Good	Average
1	2.08.18	ENGLISH		✓		

4. Two positive points about the programme:

It was very interactive and entertaining.
And it helped us to overcome the obstacles of stage fear.

5. Suggestions for improvement:

Activities for the student should be increased.

Date: 02.08.18

S. Tejaswini
Signature



Name of the Student: K. Thangam Kumar Branch: ECE

Year / Sem: II - III

4. Name of the Training: BASIC COMMUNICATION SKILL

5. Name of the Trainer: MUKUNTHRAJAN

6. Students rating of Trainers: 10

S. No.	Date	Subject	Rating (✓)			
			Excellent	Very good	Good	Average
1	2.08.18	English		✓		

4. Two positive points about the programme:

It was very interactive and entertaining and it helped us to overcome the obstacles of stage fear.

5. Suggestions for improvement:

Activities for the student should be increased.

Date:

2/8/18

Signature

PRINCIPAL,
K. S. R. INSTITUTE FOR
ENGINEERING AND TECHNOLOGY,
K. S. R. KALVI NAGAR,
TIRUCHENGODE-637 215,
NAMAKKAL Dt, TAMIL NADU.

K. Thangam

Name of the Student: PARKAVI. S Branch: ECEYear / Sem: II / III1. Name of the Training: COMMUNICATION SKILLS2. Name of the Trainer: DR. C. MUGUNDHARAJAN3. Students rating of Trainers: 10

S. No.	Date	Subject	Rating (✓)			
			Excellent	Very good	Good	Average
1	2.8.18	ENGLISH		✓		

4. Two positive points about the programme: 1. We enjoyed a lot during this program. 2. We improved something better than before.

5. Suggestions for improvement:

We need more activity.Date: 3.8.18Signature: [Signature]Name of the Student: Priyanka. V Branch: ECEYear / Sem: II / III4. Name of the Training: Communication Skills5. Name of the Trainer: Dr. C. Mugundharajan6. Students rating of Trainers: 9

S. No.	Date	Subject	Rating (✓)			
			Excellent	Very good	Good	Average
1	2.8.2018	English	✓			

4. Two positive points about the programme: We learn about language and how to improve our soft skills.

5. Suggestions for improvement: ✓

Date: 2.8.2018

PRINCIPAL,
K. S. R. INSTITUTE FOR
ENGINEERING AND TECHNOLOGY,
K. S. R. KALVI NAGAR,
TIRUCHENGODE-637 215,
NAMAKKAL Dt, TAMIL NADU.

Signature: [Signature]



Ref: KSRIET/T&P/CIR/2018-19

Date: 16.07.2018

This is to inform that all the HoDs, Faculty and Department Training and Placement coordinator that One day External Training Programme for IV Year VURAM Technologies & Genesys drive Eligible Students for the academic year 2018-2019 (Odd Sem) by Six Phrase has been scheduled. All the Eligible students should attend the Training Programme without fail. If any student skips this Training Programme without proper permission from the respective HoDs, he / she will not be permitted for any further Training Programme and campus recruitment process. Proper Dress Code is mandatory.

S.No	Date(s)	Department - Strength
1	17.07.2018	IT-02, ECE-04 + 02(Genesys) EEE-05, Mech-10 Venue: IT Lab

T&P OFFICER

T&P COORDINATOR

PRINCIPAL

Copy to:
1. All HoDs

Session Timings:

Forenoon Session: 09.00 AM to 12.30 PM

Break: 10.45 AM to 11.00 AM

Afternoon Session: 01.15 PM to 04.15 PM

Lunch: 12.30 PM to 01.15 PM

PRINCIPAL,
K. S. R. INSTITUTE FOR
ENGINEERING AND TECHNOLOGY,
K. S. R. KALVI NAGAR,
TIRUCHENGODE-637 215,
NAMAKKAL DI. TAMIL NADU.

K S R INSTITUTE FOR ENGINEERING AND TECHNOLOGY, Tiruchengode

Training and Placement Cell

Genesys & Vuram Technology solutions Company Specific Training by Six Phrase

BATCH : 2015 - 2019

Sem: Odd

Academic Year: 2018 - 2019

Date of Trainng Programme				17.07.2018	
S. No	Reg No	Name	Branch	FN	AN
1	731615205016	DIVYA.R	IT	/	/
2	731615205036	SARAVANAPRIYA R	IT	/	/
3	731615106009	BHUVANESWARI.R	ECE	/	/
4	731615106024	GOWRI.P	ECE	/	/
5	731615106029	JAYABHARATHI.S	ECE	a	a
6	731615106036	KAVIPREETHI.V	ECE	/	/
7	731615106077	UMA MAHESHWARI M	ECE	/	/
8	731615106079	VINOTHINI G	ECE	/	/
9	731615105002	ARUNKUMAR C	EEE	/	/
10	731615105029	HARINI S	EEE	/	/
11	731615105030	JANANI R	EEE	/	/
12	731615105076	SRINIVASAN R	EEE	/	/
13	731615105086	YOGAPRIYA S	EEE	/	/
14	731615114001	ADHISHANKARAN D	MECH	/	/
15	731615114042	GABY SACHIN S	MECH	/	/
16	731615114098	NISHANTHI B	MECH	/	/
17	731615114302	ARUN AKASH S	MECH	/	/
18	731615114072	LOGANATHAN K	MECH	a	a
19	731615114080	MANOJKUMAR P R	MECH	/	/
20	731615114117	SAI HARISH V	MECH	/	/
21	731615114123	SANTHOSH KUMAR R	MECH	/	/
22	731615114146	SURYA S C	MECH	/	/
23	731615114158	VIGNESH M	MECH	/	/
PRESENT				21	21
ABSENT				2	2

PRINCIPAL,
K. S. R. INSTITUTE FOR
ENGINEERING AND TECHNOLOGY,
K. S. R. KALVI NAGAR,
TIRUCHENGODE-637 215,
NAMAKKAL DI, TAMIL NADU.

**K S R INSTITUTE FOR ENGINEERING AND TECHNOLOGY
TIRUCHENGODE - 637 215**

TRAINING PROGRAMME FEEDBACK FORM



Name of the Student: R. DIVYA Branch: IT

Year / Sem: Final Year / 7th Sem

1. Name of the Training: Genesys & Vuram Specific Training

2. Name of the Trainer: Ms. Sharmi

3. Students rating of Trainers: 8.5

S. No.	Date	Subject	Rating (✓)			
			Excellent	Very good	Good	Average
1	17.7.18	Genesys & Vuram Specific Training	✓			

4. Two positive points about the programme:

- * It is very useful for solve the problem.
- * Easy to understand the program.

5. Suggestions for improvement:

- * more topics.

Date: 17/7/18

R. Deyu
Signature

**K S R INSTITUTE FOR ENGINEERING AND TECHNOLOGY
TIRUCHENGODE - 637 215**

TRAINING PROGRAMME FEEDBACK FORM



Name of the Student: P. Gowri Branch: ECE

Year / Sem: Final Year / 7th Sem

1. Name of the Training: Genesys & Vuram Specific Training

2. Name of the Trainer: Ms. Sharmi

3. Students rating of Trainers: 9

S. No.	Date	Subject	Rating (✓)			
			Excellent	Very good	Good	Average
1	17/7/18	Genesys & Vuram Specific Training		✓		

4. Two positive points about the programme:

- * Self motivated.

5. Suggestions for improvement:

- * Good Teaching.

Date: 17/7/18 → The way of Teaching Speed decrease.

PRINCIPAL,
K. S. R. INSTITUTE FOR
ENGINEERING AND TECHNOLOGY,
K. S. R. RAJIV NAGAR
TIRUCHENGODE - 637 215.
 Signature: _____

**K S R INSTITUTE FOR ENGINEERING AND TECHNOLOGY
TIRUCHENGODE - 637 215**

TRAINING PROGRAMME FEEDBACK FORM



Name of the Student: ARUN AKASH.S Branch: MECH

Year / Sem: Final Year / 7th Sem

1. Name of the Training: Genesys & Varam Specific Training

2. Name of the Trainer: Ms. Sharmi

3. Students rating of Trainers: 8

S. No.	Date	Subject	Rating (√)			
			Excellent	Very good	Good	Average
1	17/7/18	Genesys & Varam Specific Training	✓			

4. Two positive points about the programme:

- * Good Presentation
- * Reduce the Paper work.

5. Suggestions for improvement:

Nil

S. Arun Arul

Signature

Date: 17/7/18

**K S R INSTITUTE FOR ENGINEERING AND TECHNOLOGY
TIRUCHENGODE - 637 215**

TRAINING PROGRAMME FEEDBACK FORM



Name of the Student: Harini.S Branch: EEE

Year / Sem: Final year / 7th

1. Name of the Training: Genesys & Varam Specific Training

2. Name of the Trainer: Ms. Sharmi

3. Students rating of Trainers: 8

S. No.	Date	Subject	Rating (√)			
			Excellent	Very good	Good	Average
1	17.7.18	Specific training		✓		

4. Two positive points about the programme:

- Concept has been understand very well

5. Suggestions for improvement:

more topic should be cover.

Date: 17.7.18

PRINCIPAL,
K. S. R. INSTITUTE FOR
ENGINEERING AND TECHNOLOGY,
K. S. RAJAN NAGAR,
TIRUCHENGODE - 637 215,
NAMAKKAL Dt, TAMIL NADU.



K S R IET T&P <ksrietplacement@gmail.com>

Fwd: Meeting Summary | KSR College of Technology

4 messages

KSR EI <ksreiplacement@gmail.com>

Tue, Jul 10, 2018 at 1:43 PM

To: ksreiplacement <ksreiplacement@gmail.com>, ksreiplacement <ksreiplacement@gmail.com>, ksrietplacement <ksrietplacement@gmail.com>

Cc: principal <principal@ksrct.ac.in>, principal <principal@ksrce.ac.in>, principal <principal@ksriet.ac.in>, ceoksrei@gmail.com, "Dr.K.Thiyagarajah Principal" <drkt52@gmail.com>

Dear Team

Below mail is FYI. We may plan our third year students for the same.

Pls discuss.

Thanks & Regards,

Dr.R.Gopalakrishnan

Placement Officer

K.S.R. Educational Institutions

Contact Number : 95430 55555 | 99941 50505

----- Forwarded message -----

From: Mownesh S <mownesh@focusacademy.in>

Date: Wed, Jul 4, 2018 at 8:27 AM

Subject: Meeting Summary | KSR College of Technology

To: Gopal Krishnan - KSRCT PO <placement@ksrei.org>, oplan - KSRCT PO <placement@ksrct.ac.in>

Cc: Deepak G <deepak@focusacademy.in>

Dear Dr Gopalakrishnan Sir,

Greetings from FACE - Focus Academy for Career Enhancement, An IIM Graduates' Enterprise & India's Largest Skill Development Organisation.

Hope things are going great at your end; it was indeed a great pleasure interacting with you at your office. I sincerely thank you for giving us an opportunity to better understand your requirements. Please find the significant points discussed during the meeting below.

- We discussed the Robotics Process Automation Course by Automation Anywhere University that could be planned for our students.
- We discussed the whole process of the AA University in setting up the Centre of Excellence.

We sincerely appreciate the effort taken and interest expressed by you and your institution for being a part of this novel initiative towards creating a sustainable ecosystem to train students on RPA.

As discussed, we along with Automation Anywhere University are keen on setting up a Center of Excellence at your esteemed institution which does not involve any financial investment from the institution.

To initiate the COE setup we would want all your final year and pre-final year students to take up the online course hosted by Automation Anywhere University. For which we request you to share the student details for creating login credentials in the attached format.

https://mail.google.com/mail/u/0/?ui=2&ik=4f78d20f09&jsver=UL5aI9I1CnU.en.&cbl=gmail_fe_180723.12_p7&view=pt&cpa&qqs=true&search=query... 1/4

 K S R INSTITUTE FOR
 ENGINEERING AND TECHNOLOGY,
 K. S. R. KALVINAGAR
 TIRUCHENGODE 613 015,
 NAIMAKKAL DT. TAMIL NADU.

I have also attached a detailed concept note on how this partnership would benefit your institution and help your students in chasing their chosen career aspirations.

Looking forward to working with you in similar avenues.

Thanks & Best Regards,
Mownesh.

Mownesh.S
Manager - Business Development.



Focus Academy for Career Enhancement

An IIM Graduates' Enterprise

12, Lakshmi Nagar, Off Avinashi Road, Coimbatore - 641014 | Tel: +91 422 4506070 | Mobile: +91 73395 39667 | Email: mownesh@focusacademy.in | Website: www.focusacademy.in

The information contained in this email and any attachments is confidential and may be subject to copyright or other intellectual property protection. If you are not the intended recipient, you are not authorized to use or disclose this information, and we request you to notify us by reply mail at email@focusacademy.in or telephone and delete the original message from your mail system.

4 attachments

- ELearning- User Access Request (1).xlsx**
40K
- Final AAU - Center of Excellence.pdf**
144K
- Automation Anywhere University - Course Content.pdf**
98K
- RPA and Automation Anywhere - April 2018.pdf**
780K

KSRIET TRAINING AND PLACEMENT <ksrietplacement@gmail.com>

Wed, Jul 11, 2018 at 11:16 AM

To: Dept Mails <ksrietcseplacement@gmail.com>, Dept Mails <ksrieteceplacement@gmail.com>, ksrieteplacement <ksrieteplacement@gmail.com>, KSRIET IT <ksrietitplacement@gmail.com>, Dept Mails <ksrietmechplacement@gmail.com>

Dear Sir,

Kindly share the interested students database in the attached format on or before end of the day.

Thanks & Regards,
T & P Team
Training and Placement Cell
K.S.R Institute for Engineering and Technology
K S R Kalvi Nagar, Tiruchengode
Contact Number:9942733333



[Quoted text hidden]

4 attachments

- ELearning- User Access Request (1).xlsx**
40K

https://mail.google.com/mail/u/0/?ui=2&ik=4f78d20f09&jsver=UL5a9l1CnU.en.&cbl=gmail_fe_180723_12_p7&view=pt&q=rpa&qs=true&search=query... 2/4

PRINCIPAL
K. S. R. INSTITUTE FOR
ENGINEERING AND TECHNOLOGY,
K. S. R. KALVI NAGAR,
TIRUCHENGODE-637 215,
NAMAKKAL Dt, TAMIL NADU.

TRAINING AND PLACEMENT CELL

Robotic Process Automation Report - (31.07.2018 & 01.08.2018)

S.No	First Name	Lastname	Department / Function	Status
1	ISWARYA	P	B.E. - ECE	Completed
2	AKSHAYA	N.M	B.E. - ECE	Completed
3	BHAVYASHREE	S	B.E. - ECE	Completed
4	JAYASHRI	M	B.E. - ECE	Completed
5	ILAKIYA	S	B.E. - ECE	Completed
6	NIVETHA	S	B.E. - ECE	Completed
7	PRAVEENA	M	B.E. - ECE	Completed
8	SRIMATHI	G	B.E. - ECE	Completed
9	SANTHIA	G	B.E. - ECE	Completed
10	PRIYANKA	S	B.E. - ECE	Completed
11	NIVETHA	T	B.E. - ECE	Completed
12	YOGESH	S	B.E. - ECE	Completed
13	VIGNESH	R	B.E. - ECE	Completed
14	ASWIN	S	B.E. - ECE	Completed
15	BRAHADEESHWARAN	M	B.E. - ECE	Completed
16	DURAIRAJ	S	B.E. - ECE	Completed
17	BALAJI	R	B.E. - ECE	Completed
18	MARIMUTHU	M	B.E. - ECE	Completed
19	ANANTHA KRISHNAN	P	B.E. - ECE	Completed
20	LOGESH KUMAR	K	B.E. - ECE	Completed
21	ABDULKADHAR	S	B.E. - ECE	Completed
22	INDIRAKUMAR	M	B.E. - ECE	Completed
23	RAMYA SRI	E	B.E. - ECE	Completed
24	SUMATHI	R	B.E. - ECE	Completed
25	ROSHINI	T	B.E. - ECE	Completed
26	TAMILARASI	S	B.E. - ECE	Completed
27	AJITH KUMAR	P	B.E. - CSE	Completed
28	ANISHA	N	B.E. - CSE	Completed
29	ARUN	R	B.E. - CSE	Completed
30	GOWTHAMAKUMARAN	P	B.E. - CSE	Completed
31	ILAKIYA	S	B.E. - CSE	Completed
32	KAMALESH	M	B.E. - CSE	Completed
33	LAXMANCIBI	S	B.E. - CSE	Completed

PRINCIPAL,
K. S. R. INSTITUTE FOR
ENGINEERING AND TECHNOLOGY,
K. S. R. KALVI NAGAR,
TIRUCHENGODE-637 215.
NAMAKKAL Dt. TAMIL NADU.

S.No	First Name	Lastname	Department / Function	Status
34	MANIKANDAN	K	B.E. - CSE	Completed
35	MEGASURIYAN	E	B.E. - CSE	Completed
36	MOHAMMEDSAMIR	A	B.E. - CSE	Completed
37	NATHISH KUMAR	A	B.E. - CSE	Completed
38	PAVITHIRAN	S	B.E. - CSE	Completed
39	PRAVEEN KUMAR	M	B.E. - CSE	Completed
40	PREMNATH	R	B.E. - CSE	Completed
41	PUGAZHIVELAN	P	B.E. - CSE	Completed
42	RAJARAJAN	A	B.E. - CSE	Completed
43	SELVAMALINI	J	B.E. - CSE	Completed
44	STELINBERCIA	S	B.E. - CSE	Completed
45	SWETHA	B	B.E. - CSE	Completed
46	SWETHA	C	B.E. - CSE	Completed
47	VASU MITHA	S	B.E. - CSE	Completed
48	VELU PRABHA	S	B.E. - CSE	Completed
49	YUVAPRIYANKA	V	B.E. - CSE	Completed
50	BHARATHI KANNAN	M R	B.E. - EEE	Completed
51	KAMALI SOUNDARYA	B	B.E. - EEE	Completed
52	MADHUMITHA	J S	B.E. - EEE	Completed
53	MANOJKUMAR	V	B.E. - EEE	Completed
54	MERLIN INFANTA	S	B.E. - EEE	Completed
55	MONISHA	S	B.E. - EEE	Completed
56	NITHIYASRI	R	B.E. - EEE	Completed
57	PREETHA	E	B.E. - EEE	Completed
58	SARANYA	P	B.E. - EEE	Completed
59	SARAVANAN	V	B.E. - EEE	Completed
60	SHANKAR NARAYAN	M	B.E. - EEE	Completed
61	SUVETHA	T	B.E. - EEE	Completed
62	KARTHI	K	B.E. - EEE	Completed
63	GOWRI D	D	B. TECH - IT	Completed
64	JANANI M	M	B. TECH - IT	Completed
65	JANANI T	T	B. TECH - IT	Completed
66	MOHANRAJ S	J S	B. TECH - IT	Completed
67	OVIYA A	A	B. TECH - IT	Completed
68	PRIYADARSHNI G	G	B. TECH - IT	Completed
69	SARASWATHY K	K	B. TECH - IT	Completed
70	SWETHA	S	B. TECH - IT	Completed

PRINCIPAL
K. S. R. INSTITUTE FOR
ENGINEERING AND TECHNOLOGY
K. S. R. KALVI NAGAR
TIRUCHENGODE
NAMAKKAL Dt. TAMIL NADU.

K S R INSTITUTE FOR ENGINEERING AND TECHNOLOGY, TIRUCHENGODE - 637215
TRAINING & PLACEMENT CELL -



Internal Elintz Labs Training Programme

BATCH: 2015 - 2019

ACADEMIC YEAR: 2018 - 2019 (ODD)

Date: 20.09.2018

S.No	Date	Forenoon	Afternoon
		09.00 am - 12.30 pm	01.30 pm - 04.30 pm
1	21.09.2018	Basic Electronics by J. Divakaran AP / ECE & Communication Systems Training By M.V. Mahesh AP / ECE	Embedded Systems (Processors & Controllers) by A.Murugesan AP / EEE
		Training Coordination by EEE Faculty	
2	22.09.2018	Artificial Intelligence & Robotics by External Trainer	Technical Preparation
		Training Coordination by ECE Faculty	
3	24.09.2018	Basic of C Programming Language by Mr. Jagatheeswaran, KSREI Trainer	Preparation

[Signature]
T & P Officer 20/09/18

[Signature]
Coordinator 20/9/18

[Signature]
Principal

[Signature]
PRINCIPAL.
K. S. R. INSTITUTE FOR
ENGINEERING AND TECHNOLOGY,
K. S. R. KALVI NAGAR,
TIRUCHENGODE - 637 215,
NAMAKKAL DISTRICT, TAMIL NADU.

K S R INSTITUTE FOR ENGINEERING AND TECHNOLOGY, TIRUCHENGODE 637215
TRAINING AND PLACEMENT CELL
ELINT LABS TRAINING ATTENDANCE

S.No.	Reg.No.	Name	College	Degree	Branch	21.09.18	22.09.18	
1	731615105033	JEEVAPRAKASH V	KSRIET	B.E.	EEE	OD	/	/
2	731615105075	SRINITHI G	KSRIET	B.E.	EEE	/	/	/
3	731615105086	YOGAPRIYA S	KSRIET	B.E.	EEE	/	/	/
4	731615105049	MAHAESWARI A	KSRIET	B.E.	EEE	/	/	/
5	731615105057	MURUGANANTH M	KSRIET	B.E.	EEE	/	/	/
6	731615105076	SRINIVASAN R	KSRIET	B.E.	EEE	/	/	/
7	731615105073	SOUNDHARYA S	KSRIET	B.E.	EEE	/	/	/
8	731615105077	STEPHEN IMMANUVEL	KSRIET	B.E.	EEE	/	/	/
9	731615105087	YOGESHWARAN S	KSRIET	B.E.	EEE	/	/	/
10	731615105007	DHIVAGAR N	KSRIET	B.E.	EEE	/	/	/
11	731615105023	GOWTHAM S	KSRIET	B.E.	EEE	/	/	/
12	731615105044	KRISHNAMOORTHIS	KSRIET	B.E.	EEE	/	/	/
13	731615105024	GOWTHAM V	KSRIET	B.E.	EEE	/	/	/
14	731615105029	HARINI S	KSRIET	B.E.	EEE	/	/	/
15	731615105004	CATHRINAL J	KSRIET	B.E.	EEE	/	/	/
16	731615105012	GAYATHRI K	KSRIET	B.E.	EEE	/	/	/
17	731615105021	GOWSALYA A	KSRIET	B.E.	EEE	/	/	/
18	731615105014	GOBINATH V P	KSRIET	B.E.	EEE	/	a	a
19	731615105025	HAGASTHIYA R J	KSRIET	B.E.	EEE	/	/	/
20	731615105005	CHIDAMBARAM V	KSRIET	B.E.	EEE	/	/	/
21	731615105026	HARIHARAN G	KSRIET	B.E.	EEE	/	/	/
22	731615105035	KANNAN S	KSRIET	B.E.	EEE	/	a	a
23	731615106001	ALEXRAJA	KSRIET	B.E.	ECE	/	/	/
24	731615106012	DEVI.U	KSRIET	B.E.	ECE	/	/	/
25	731615106013	DHARANIR	KSRIET	B.E.	ECE	/	/	/
26	731615106073	SUGANTHIS	KSRIET	B.E.	ECE	/	/	/
27	731615106074	TAMILARASI J	KSRIET	B.E.	ECE	/	/	/
28	731615106079	VINOTHINI G	KSRIET	B.E.	ECE	/	/	/
29	731615106054	PAVITHRA P	KSRIET	B.E.	ECE	/	/	/
30	731615106076	THARUNYA.S	KSRIET	B.E.	ECE	/	L	/
31	731615106077	UMA MAHESHWARI M	KSRIET	B.E.	ECE	/	/	/
32	731615106057	PRAVEEN KUMAR V	KSRIET	B.E.	ECE	/	/	/
33	731615105055	MONISHA V	KSRIET	B.E.	EEE	/	/	/
34	731615105059	NAVEEN KUMAR S	KSRIET	B.E.	EEE	/	/	/
35	731615105080	SWATHI S	KSRIET	B.E.	EEE	/	/	/

PRINCIPAL,
K. S. R. INSTITUTE FOR
ENGINEERING AND TECHNOLOGY,
K. S. R. KALVINAGAR,
TIRUCHENGODE - 637 215,
NAMAKKAL Dt, TAMIL NADU.

**K S R INSTITUTE FOR ENGINEERING AND TECHNOLOGY
TIRUCHENGODE – 637 215**



TRAINING PROGRAMME FEEDBACK FORM

Name of the Student: Grinidhi G. Branch: EEE

Year / Sem: IV / 7th

1. Name of the Training : Elintz lab training
2. Name of the Trainer : ECE & EEE department faculty
3. Students rating of Trainers : 7

S. No.	Date	Subject	Rating (√)			
			Excellent	Very good	Good	Average
1	21.9.18	Elintz training		✓		

4. Two positive points about the programme:
Good content

5. Suggestions for improvement:
Interaction has very poor

Date: 21.9.18

[Signature]
Signature

**K S R INSTITUTE FOR ENGINEERING AND TECHNOLOGY
TIRUCHENGODE – 637 215**



TRAINING PROGRAMME FEEDBACK FORM

Name of the Student: Pavithra P Branch: ECE

Year / Sem: IV / 7th

1. Name of the Training : elintz lab training
2. Name of the Trainer : ECE & EEE Department faculty
3. Students rating of Trainers :

S. No.	Date	Subject	Rating (√)			
			Excellent	Very good	Good	Average
1	21.9.18	elintz training			✓	

4. Two positive points about the programme:
Content should be explained clearly

5. Suggestions for improvement:
Must improve the speech

Date: 21.9.18

PRINCIPAL,
K. S. R. INSTITUTE FOR
ENGINEERING AND TECHNOLOGY,
K. S. R. KALVANIGAR,
TIRUCHENGODE - 637 215,
NAMAKKAL Dt. TAMIL NADU.



Name of the Student: Swathi. S

Branch: ECE

Year / Sem: IV / VII Sem

1. Name of the Training : ELintz Labs Training

2. Name of the Trainer :

3. Students rating of Trainers : 8

S. No.	Date	Subject	Rating (√)			
			Excellent	Very good	Good	Average
1	22.9.18	ELintz Labs Training		✓		

4. Two positive points about the programme:

* Good Training Program.
* Easy to understand

5. Suggestions for improvement:

Nil

Date: 22.9.18

S. Swathi
Signature



Name of the Student: Gowtham. V

Branch: EEE

Year / Sem: IV / VII Sem

1. Name of the Training : ELintz Labs Training

2. Name of the Trainer :

3. Students rating of Trainers : 7.5

S. No.	Date	Subject	Rating (√)			
			Excellent	Very good	Good	Average
1	24.9.18	ELintz Labs Training	✓			

4. Two positive points about the programme:

* Good Points
* Good interaction with

5. Suggestions for improvement:

Nothing

Date: 24.9.18

Gowtham
Signature
PRINCIPAL,
K. S. R. INSTITUTE FOR
ENGINEERING AND TECHNOLOGY,
K S R KALVINAGAR,
TIRUCHENGODE-637 215,
NAMAKKAL DISTRICT, TAMIL NADU.

K S R INSTITUTE FOR ENGINEERING AND TECHNOLOGY, TIRUCHENGODE - 637215
TRAINING & PLACEMENT CELL -



Internal Training Programme for Aspire Systems

BATCH: 2015 - 2019

ACADEMIC YEAR: 2018 - 2019 (ODD)

Date: 27.09.2018

S.No	Date	Topics & Time	
1	27.09.2018 & 28.09.2018	Technical Preparation 01.45 pm - 04.00 pm	Aptitude Test on Six Phrase Login 04.30 pm - 06.30 pm
2	29.09.2018	Preparation on Own 09.00 am - 12.00 pm	Aspire Systems Drive @ KSREI (AN)

F. Kalvina
T & P Officer

[Signature]
T & P Coordinator 27/9/18

[Signature]
Principal

PRINCIPAL,
K. S. R. INSTITUTE FOR
ENGINEERING AND TEC
K S R KALVINA
TIRUCHENGODE

56

K.S.R. Institute for Engineering and Technology, Tiruchengode - 637215

Training and Placement Cell

Aspire Systems Drive Details - 27.09.18 - 30.09.18

S.No	Reg.No	Name of the Candidate	Aspire Systems Roll No	Branch
1	731615104007	BOOPATHIRAJA M	ASP514	CSE
2	731615104012	GUNA BHARATHI T	ASP515	CSE
3	731615104016	KIRUBHANANDHAN P	ASP516	CSE
4	731615104019	MOHANRAJ C	ASP517	CSE
5	731615104023	NISHA S	ASP518	CSE
6	731615104029	PRAVEEN G	ASP519	CSE
7	731615104030	PRIYADHARSHINI R	ASP520	CSE
8	731615104033	SAKTHIVEL E	ASP521	CSE
9	731615104044	VINOTHA V	ASP522	CSE
10	731615106009	BHUVANESWARI.R	ASP523	ECE
11	731615106015	DHIVYA.M	ASP524	ECE
12	731615106024	GOWRI.P	ASP525	ECE
13	731615106029	JAYABHARATHI.S	ASP526	ECE
14	731615106036	KAVIPREETHI.V	ASP527	ECE
15	731615106041	KOWSALYA.C	ASP528	ECE
16	731615106054	PAVITHRA P	ASP529	ECE
17	731615106059	PRIYADHARSHINI.S	ASP530	ECE
18	731615106073	SUGANTHI.S	ASP531	ECE
19	731615106074	TAMILARASI J	ASP532	ECE
20	731615106077	UMA MAHESHWARI M	ASP533	ECE
21	731615106079	VINOTHINI G	ASP534	ECE
22	731615105023	GOWTHAM S	ASP535	EEE
23	731615105044	KRISHNAMOORTHY S	ASP536	EEE
24	731615105057	MURUGANANTH M	ASP537	EEE
25	731615105076	SRINIVASAN R	ASP538	EEE
26	731615105086	YOGAPRIYA S	ASP539	EEE
27	731615105049	MAHAESWARI A	ASP540	EEE

PRINCIPAL
K. S. R. INSTITUTE FOR
ENGINEERING AND TECHNOLOGY,
K. S. R. KALVI NAGAR,
TIRUCHENGODE-637 215,
NAMAKKAL DI, TAMIL NADU.

S.No	Reg.No	Name of the Candidate	Aspire Systems Roll No	Branch
28	731615105073	SOUNDHARYA S	ASP541	EEE
29	731615105075	SRINITHI G	ASP542	EEE
30	731615205012	DHANUSYADEVI.S	ASP543	IT
31	731615205036	SARAVANAPRIYA R	ASP544	IT
32	731615205038	SNEKA D	ASP545	IT
33	731615106001	ALEXRAJ.A	ASP546	ECE
34	731615106032	KARTHIKA.D	ASP547	ECE
35	731615106045	NARESH.N	ASP548	ECE
36	731615105012	GAYATHRI K	ASP549	EEE
37	731615105017	GOKULAKRISHNAN S	ASP550	EEE
38	731615105026	HARIHARAN G	ASP551	EEE
39	731615105029	HARINI S	ASP552	EEE
40	731615105059	NAVEEN KUMAR S	ASP553	EEE
41	731615105079	SWATHI R	ASP554	EEE
42	731615105081	TAMILSELVAN M	ASP555	EEE
43	731615105030	JANANI R	ASP556	EEE
44	731615105087	YOGESHWARAN S	ASP557	EEE



Name of the Student: SNEKA.D

Branch: IT

Year / Sem: IV / VII

1. Name of the Training: Aspire System drive

2. Name of the Trainer :

3. Students rating of Trainers : 7

S. No.	Date	Subject	Rating (√)			
			Excellent	Very good	Good	Average
1	28.9.18	Aspire System drive		✓		

4. Two positive points about the programme:

* good communication.
* Excellent Approach.

5. Suggestions for improvement:

Nothing

P. Srujan
Signature

Date: 28.9.18



Name of the Student: R. Janani

Branch: EEE

Year / Sem: IV / VII

1. Name of the Training: Aspire System drive

2. Name of the Trainer :

3. Students rating of Trainers : 7.5

S. No.	Date	Subject	Rating (√)			
			Excellent	Very good	Good	Average
1	29.9.18	Aspire System drive	✓			

4. Two positive points about the programme:

A Good system work.

5. Suggestions for improvement:

To improve the skills in Communication

Date: 29.9.18

[Signature]
PRINCIPAL,
K. S. R. INSTITUTE FOR
ENGINEERING AND TECHNOLOGY
K. S. R. KALVINAGAR
TIRUCHENGODE
TAMIL NADU.



Name of the Student: NISHA.S Branch: CSE

Year / Sem: Final Year / 7th

1. Name of the Training: Aspire System drive

2. Name of the Trainer :

3. Students rating of Trainers : 8

S. No.	Date	Subject	Rating (√)			
			Excellent	Very good	Good	Average
1	27.9.18	Aspire System drive	✓			

4. Two positive points about the programme:

* Good experience
* Easy work.

5. Suggestions for improvement:

Reduce the speed of talking class.

Date: 27.9.18

S. Nisha
Signature



Name of the Student: TAMILARASI.J Branch: ECE

Year / Sem: V / VII

1. Name of the Training: Aspire System drive

2. Name of the Trainer :

3. Students rating of Trainers : 9

S. No.	Date	Subject	Rating (√)			
			Excellent	Very good	Good	Average
1	28.9.18	Aspire System drive	✓			

4. Two positive points about the programme:

Good interaction with students

5. Suggestions for improvement:

Nothing

Date: 28.9.18

[Signature]
PRINCIPAL,
K. S. R. INSTITUTE FOR
ENGINEERING AND TECHNOLOGY
K. S. R. KALVI NAGAR,
TIRUCHENGODE-637 215,
NAMAKKAL DI, TAMIL NADU.

TRAINING AND PLACEMENT CELL



Training Schedule [2018-2019] ODD Semester

Ref: KSRIET/T&P/CIR/2018-2019

Date: 20.11.18

This is to inform that all the HoD's and Training and Placement coordinators that the company specific training for IV year students(Advanced Learners) for the academic year 2018-2019 (Odd Sem) is scheduled as given below. All the eligible students should attend the Training Programme without fail. If any student skips this Training Programme he / she will not be permitted for any further Training Programme and campus recruitment process. Proper Dress Code is mandatory.

S.NO	Date	Batch	Students Strength	Resource Person
1	29.11.18 & 30.11.18	2015-2019	ECE(12) & EEE(11) Total=23	Internal ECE & EEE Faculties.

Session FN: 9.00 AM to 12.30 PM & Break: 10.45 AM to 11.00AM

Session AN: 01.15.PM to 04.15 PM & Lunch: 12.30 PM to 01.15 PM

[Signature]
T&P Officer
20/11/18

[Signature]
T&P Coordinator
20/11/18

[Signature]
Principal

- Copy to:
1. All HoDs
 2. Notice Board

[Signature]
PRINCIPAL.
K. S. R. INSTITUTE FOR
ENGINEERING AND TECHNOLOGY,
K. S. R. KALVI NAGAR,
TIRUCHENGODE-637 215,
NAMAKKAL DI, TAMIL NADU.

K S R INSTITUTE FOR ENGINEERING AND TECHNOLOGY, TIRUCHENGODE - 637215

Training and Placement Cell

VVDN Internal Training Programme - 29.11.2018 - 30.11.2018

S.No.	Reg.No.	Name	Branch
1	731615106009	BHUVANESWARI.R	ECE
2	731615106015	DHIVYA.M	ECE
3	731615106024	GOWRI.P	ECE
4	731615106029	JAYABHARATHI.S	ECE
5	731615106032	KARTHIKA.D	ECE
6	731615106036	KAVIPREETHI.V	ECE
7	731615106041	KOWSALYA.C	ECE
8	731615106054	PAVITHRA P	ECE
9	731615106059	PRIYADHARSHINI.S	ECE
10	731615106074	TAMILARASI J	ECE
11	731615106077	UMA MAHESHWARI M	ECE
12	731615106079	VINOTHINI G	ECE
13	731615105017	GOKULAKRISHNAN S	EEE
14	731615105023	GOWTHAM S	EEE
15	731615105026	HARIHARAN G	EEE
16	731615105029	HARINI S	EEE
17	731615105030	JANANI R	EEE
18	731615105049	MAHAESWARI A	EEE
19	731615105057	MURUGANANTH M	EEE
20	731615105075	SRINITHI G	EEE
21	731615105079	SWATHI R	EEE
22	731615105081	TAMILSELVAN M	EEE
23	731615105086	YOGAPRIYA S	EEE

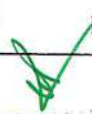
 PRINCIPAL
 K. S. R. INST. FOR
 ENGINEERING AND TECHNOLOGY,
 K. S. R. KALVINAGAR,
 TIRUCHENGODE-637 215,
 NAMAKKAL DI, TAMIL NADU.

(Approved by AICTE, New Delhi and Affiliated by Anna University, Chennai)
TRAINING AND PLACEMENT CELL

Academic year : 2018-2019

VVDN Technologies Pvt.Ltd- Internal Training Programme

Date:29.11.2018 to 30.11.2018

Student Attendance

S.No	Register No	Name of the Student	29.11.2018		30.11.2018	
			FN	AN	FN	AN
1.	731615106009	BHUVANESWARI.R	P	P	P	P
2.	731615106015	DHIVYA.M	P	P	P	P
3.	731615106024	GOWRI.P	AB	AB	P	P
4.	731615106029	JAYABHARATHI.S	P	P	P	P
5.	731615106032	KARTHIKA.D	P	P	P	P
6.	731615106036	KAVIPREETHI.V	P	P	P	P
7.	731615106041	KOWSALYA.C	P	P	P	P
8.	731615106054	PAVITHRA P	P	P	AB	AB
9.	731615106059	PRIYADHARSHINI.S	P	P	P	P
10.	731615106074	TAMILARASI J	P	P	P	P
11.	731615106077	UMA MAHESHWARI M	P	P	P	P
12.	731615106079	VINOTHINI G	AB	AB	P	P
13.	731615105017	GOKULAKRISHNAN S	P	P	AB	AB
14.	731615105026	HARIHARAN G	P	P	P	P
15.	731615105029	HARINI S	P	P	P	P
16.	731615105030	JANANI R	P	P	P	P
17.	731615105049	MAHAESWARI A	P	P	P	P
18.	731615105057	MURUGANANTH M	P	P	P	P
19.	731615105059	NAVEEN KUMAR S	P	P	P	P
20.	731615105075	SRINITHI G	P	P	P	P
21.	731615105079	SWATHI R	P	P	P	P
22.	731615105081	TAMILSELVAN M	P	P	P	P
23.	731615105086	YOGAPRIYA S	AB	AB	P	P

PRINCIPAL,
K. S. R. INSTITUTE FOR
ENGINEERING AND TECHNOLOGY,
K. S. R. KALVI NAGAR,
TIRUCHENGODE-637 215,
NAMAKKAL DI. TAMIL NADU.

**K S R INSTITUTE FOR ENGINEERING AND TECHNOLOGY
TIRUCHENGODE – 637 215**

TRAINING PROGRAMME FEEDBACK FORM



Name of the Student: Shivya M Branch: EEE
 Year / Sem: 4/8/7
 1. Name of the Training: placement
 2. Name of the Trainer: External Trainer
 3. Students rating of Trainers: 4/5

S. No.	Date	Subject	Rating (√)			
			Excellent	Very good	Good	Average
1	29/04/18	Java		✓		

4. Two positive points about the programme:

It was useful

5. Suggestions for improvement:

Need content

Date: 29/04/18

Shivya
Signature

**K S R INSTITUTE FOR ENGINEERING AND TECHNOLOGY
TIRUCHENGODE – 637 215**

TRAINING PROGRAMME FEEDBACK FORM



Name of the Student: Vinodha Branch: EEE
 Year / Sem: 4-7
 1. Name of the Training: placement
 2. Name of the Trainer: External
 3. Students rating of Trainers: 4/5

S. No.	Date	Subject	Rating (√)			
			Excellent	Very good	Good	Average
1	29/04/18	Java		✓		

4. Two positive points about the programme:

It was useful

5. Suggestions for improvement:

Need content

Date: 29/04/18

Vinodha
Signature
 PRINCIPAL,
 K. S. R. INSTITUTE FOR
 ENGINEERING AND TECHNOLOGY,
 K. S. R. KALVINAGAR,
 TIRUCHENGODE-637 215,
 NAMAKKAL DT. TAMIL NADU.

TRAINING PROGRAMME FEEDBACK FORM



Name of the Student: Gowri P Branch: EEE
 Year / Sem: V-7
 1. Name of the Training: placement
 2. Name of the Trainer: Gond
 3. Students rating of Trainers: 4/5

S. No.	Date	Subject	Rating (√)			
			Excellent	Very good	Good	Average
1	27/11/18	Java		✓		

4. Two positive points about the programme:

Useful content

5. Suggestions for improvement:

Need more

Date: 29/11/18

Gowri
Signature

TRAINING PROGRAMME FEEDBACK FORM



Name of the Student: poovithra p Branch: EEE
 Year / Sem: V-7
 1. Name of the Training: placement
 2. Name of the Trainer: Gond
 3. Students rating of Trainers: 4/5

S. No.	Date	Subject	Rating (√)			
			Excellent	Very good	Good	Average
1	29/11/18	Java		✓		

4. Two positive points about the programme:

IT was useful

5. Suggestions for improvement:

Need more

Date: 29/11/18

PRINCIPAL
K. S. R. INSTITUTE FOR
ENGINEERING AND TECHNOLOGY
K. S. R. KALVI NAGAR
TIRUCHENGODE - 637 215
TAMIL NADU
[Signature]

Ref: KSRIET/T&P/CIR/2018-2019

Date: 28.11.18

This is to inform that all the HoD's and Training and Placement coordinators that the company specific training for IV year students(Advanced Learners) for the academic year 2018-2019 (Odd Sem) is scheduled as given below. All the eligible students should attend the Training Programme without fail. If any student skips this Training Programme he / she will not be permitted for any further Training Programme and campus recruitment process. Proper Dress Code is mandatory.

S.NO	Date	Batch	Students Strength	Resource Person
1	03.12.18	2015-2019	MECH(2) & EEE(17) Total=19	Dr.A.Murugesan,AP/EEE

Session FN: 9.00 AM to 12.30 PM & Break: 10.45 AM to 11.00AM

Session AN: 01.15.PM to 04.15 PM & Lunch: 12.30 PM to 01.15 PM

 T&P Officer

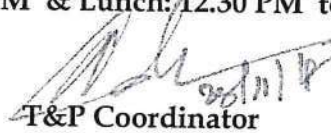
 T&P Coordinator

 Principal

Copy to: 1. All HoDs
2. Notice Board

 PRINCIPAL,
 K. S. R. INSTITUTE FOR
 ENGINEERING AND TECHNOLOGY,
 K. S. R. KALVI NAGAR
 TIRUCHENGODE - 637 215,
 NAMAKKAL DI. TAMIL NADU.

S.No.	Reg.No.	Name	Branch
1	731615105011	ELANCHEZHIAN P	EEE
2	731615105017	GOKULAKRISHNAN S	EEE
3	731615114016	BALAJI RAM G	MECH
4	731615114029	DHANASEKAR R	MECH
5	731615114048	GOKUL MAYURA PRIYAN B	MECH
6	731615114053	HARIRAJ K	MECH
7	731615114058	JAGADESHWARAN S	MECH
8	731615114302	ARUN AKASH S	MECH
9	731615114066	KAVIPRIYAN S	MECH
10	731615114097	NISHANTH E	MECH
11	731615114109	RAGU S	MECH
12	731615114111	RAMANA SARATHI A T	MECH
13	731615114135	SHREERAM M R	MECH
14	731615114146	SURYA S C	MECH
15	731615114147	SYLESH P	MECH
16	731615114158	VIGNESH M	MECH
17	731615114161	VIJAY M	MECH
18	731615114302	ARUN AKASH S	MECH
19	731615114313	NAVEEN A	MECH

PRINCIPAL,
K. S. R. INSTITUTE FOR
ENGINEERING AND TECHNOLOGY,
K. S. R. KALVI NAGAR
TIRUCHENGODE - 637 215,
NAMAKKAL DL, TAMIL NADU.

(Approved by AICTE, New Delhi and Affiliated by Anna University, Chennai)

TRAINING AND PLACEMENT CELL

Go Speedy Go Internal Training Programme

Academic year : 2018-2019

Date: 03.12.2018

Student Attendance

S.No	Register No	Name of the Student	03.12.2018	
			FN	AN
1.	731615105011	ELANCHEZHIAN P	P	P
2.	731615105017	GOKULAKRISHNAN S	P	P
3.	731615114016	BALAJI RAM G	P	P
4.	731615114029	DHANASEKAR R	P	P
5.	731615114048	GOKUL MAYURA PRIYAN B	P	P
6.	731615114053	HARIRAJ K	AB	AB
7.	731615114058	JAGADESHWARAN S	P	P
8.	731615114302	ARUN AKASH S	P	P
9.	731615114066	KAVIPRIYAN S	AB	AB
10.	731615114097	NISHANTH E	P	P
11.	731615114109	RAGU S	P	P
12.	731615114111	RAMANA SARATHI A T	P	P
13.	731615114135	SHREERAM M R	P	P
14.	731615114146	SURYA S C	P	P
15.	731615114147	SYLESH P	P	P
16.	731615114158	VIGNESH M	P	P
17.	731615114161	VIJAY M	P	P

PRINCIPAL,
K. S. R. INSTITUTE FOR
ENGINEERING AND TECHNOLOGY,
K. S. R. KALVI NAGAR
TIRUCHENGODE-637 215,
NAMAKKAL DT, TAMIL NADU.

S.No	Register No	Name of the Student	03.12.2018	
			FN	AN
18.	731615114302	ARUN AKASH S	P	P
19.	731615114313	NAVEEN A	P	P

 PRINCIPAL,
 K. S. R. INSTITUTE FOR
 ENGINEERING AND TECHNOLOGY,
 K. S. R. KALVI NAGAR,
 TIRUCHENGODE -637 215,
 NAMAKKAL DI, TAMIL NADU.

TRAINING PROGRAMME FEEDBACK FORM



Name of the Student: Arjun Akash S Branch: ECE

Year / Sem: IV - 1

1. Name of the Training : Internal training program

2. Name of the Trainer : Gopal

3. Students rating of Trainers : 4/5

S. No.	Date	Subject	Rating (√)			
			Excellent	Very good	Good	Average
1	3/12/18	Java		✓		

4. Two positive points about the programme:

It was useful

5. Suggestions for improvement:

Need more content

Date: 3/12/18

[Signature]
Signature

TRAINING PROGRAMME FEEDBACK FORM



Name of the Student: Naveen A Branch: ECE

Year / Sem: IV - 1

1. Name of the Training : Internal training program

2. Name of the Trainer : Gopal

3. Students rating of Trainers : 4/5

S. No.	Date	Subject	Rating (√)			
			Excellent	Very good	Good	Average
1	3/12/18	Java		✓		

4. Two positive points about the programme:

It was useful

5. Suggestions for improvement:

Need more content

Date: 3/12/18

[Signature]
PRINCIPAL,
K. S. R. INSTITUTE FOR
ENGINEERING AND TECHNOLOGY
K. S. R. KALVI NAGAR
TIRUCHENGODE - 637 215,
NAMAKKAL DI, TAMIL NADU.



Ref: KSRIET/T&P/CIR/2018-2019

Date: 28.11.18

This is to inform that all the HoD's and Training and Placement coordinators that the company specific training for IV year students(Advanced Learners) for the academic year 2018-2019 (Odd Sem) is scheduled as given below. All the eligible students should attend the Training Programme without fail. If any student skips this Training Programme he / she will not be permitted for any further Training Programme and campus recruitment process. Proper Dress Code is mandatory.

60

S.NO	Date	Batch	Students Strength	Resource Person
1	06.12.2018	2015-2019	CSE(9), & IT(2) Total=11	Mr.R.Gopal,AP/CSE & Mr.Selvakumar,AP/IT

Session FN: 9.00 AM to 12.30 PM & Break: 10.45 AM to 11.00AM

Session AN: 01.15.PM to 04.15 PM & Lunch: 12.30 PM to 01.15 PM

[Signature]
T&P Officer

[Signature]
T&P Coordinator

[Signature]
Principal

- Copy to:
1. All HoDs
 2. Notice Board

[Green Checkmark]
PRINCIPAL.
K. S. R. INSTITUTE FOR
ENGINEERING AND TECHNOLOGY,
K. S. R. KALVI NAGAR,
TIRUCHENGODE-637 215,
NAMAKKAL Dt. Tamil Nadu.

Training and Placement Cell

Clustrex data Private Limited Internal Training Programme - 06.12.2018

S.No.	Reg.No.	Name	Branch
1	731615104007	BOOPATHIRAJA M	CSE
2	731615104012	GUNA BHARATHI T	CSE
3	731615104016	KIRUBHANANDHAN P	CSE
4	731615104019	MOHANRAJ C	CSE
5	731615104023	NISHA S	CSE
6	731615104029	PRAVEEN G	CSE
7	731615104030	PRIYADHARSHINI R	CSE
8	731615104033	SAKTHIVEL E	CSE
9	731615104044	VINOTHA V	CSE
10	731615205012	DHANUSYADEVI.S	IT
11	731615205038	SNEKA D	IT

PRINCIPAL,
K. S. R. INSTITUTE FOR
ENGINEERING AND TECHNOLOGY,
K. S. R. KALVI NAGAR,
TIRUCHENGODE-637 215,
NAMAKKAL DI, TAMIL NADU.

(Approved by AICTE, New Delhi and Affiliated by Anna University, Chennai)

TRAINING AND PLACEMENT CELL

Academic year : 2018-2019

Clustrex Data Private Ltd, Internal Training Programme

Date:06.12.2018

Student Attendance

S.No	Register No	Name of the Student	06.12.2018	
			FN	AN
1.	731615104007	BOOPATHIRAJA M	P	P
2.	731615104012	GUNA BHARATHI T	P	P
3.	731615104016	KIRUBHANANDHAN P	P	P
4.	731615104019	MOHANRAJ C	P	P
5.	731615104023	NISHA S	P	P
6.	731615104029	PRAVEEN G	P	P
7.	731615104030	PRIYADHARSHINI R	P	P
8.	731615104033	SAKTHIVEL E	P	P
9.	731615104044	VINOTHA V	P	P
10.	731615205012	DHANUSYADEVILS	AB	AB
11.	7316152050378	SNEKA D	P	P

PRINCIPAL.
K. S. R. INSTITUTE FOR
ENGINEERING AND TECHNOLOGY,
K. S. R. KALVI NAGAR
TIRUCHENGODE-637 215,
NAMAKKAL DL, TAMIL NADU.

**K S R INSTITUTE FOR ENGINEERING AND TECHNOLOGY
TIRUCHENGODE – 637 215**

TRAINING PROGRAMME FEEDBACK FORM



Name of the Student: Alisha S Branch: CSE

Year / Sem: IV-1

1. Name of the Training : Placement

2. Name of the Trainer : Gopal

3. Students rating of Trainers : 4/5

S. No.	Date	Subject	Rating (√)			
			Excellent	Very good	Good	Average
1	6/12/19	Java		✓		

4. Two positive points about the programme:

It was useful

5. Suggestions for improvement:

need more content

Date: 6/12/19

Alisha S
Signature

**K S R INSTITUTE FOR ENGINEERING AND TECHNOLOGY
TIRUCHENGODE – 637 215**

TRAINING PROGRAMME FEEDBACK FORM



Name of the Student: Pratheek B Branch: CSE

Year / Sem: IV-1

1. Name of the Training : Placement

2. Name of the Trainer : Gopal

3. Students rating of Trainers : 4/5

S. No.	Date	Subject	Rating (√)			
			Excellent	Very good	Good	Average
1	6/12/19	Java		✓		

4. Two positive points about the programme:

It was useful

5. Suggestions for improvement:

need more content

Date: 6/12/19

PRINCIPAL.
K. S. R. INSTITUTE FOR
ENGINEERING AND TECHNOLOGY
K. S. R. KALVI NAGAR,
TIRUCHENGODE-637 215,
NAMAKKAL DI. TAMIL NADU.
Pratheek B
 Signature

Training Schedule [2018-2019] ODD Semester

Ref: KSRIET/T&P/CIR/2018-2019

Date: 10.12.2018

This is to inform that all the HoD's and Training and Placement coordinators that the company specific training for IV year students(Advanced Learners) for the academic year 2018-2019 (Odd Sem) is scheduled as given below. All the eligible students should attend the Training Programme without fail. If any student skips this Training Programme he / she will not be permitted for any further Training Programme and campus recruitment process. Proper Dress Code is mandatory.

S.NO	Date	Batch	Students Strength	Resource Person
1	19.12.2018	2015-2019	MECH(19) Total=19	Mr.D.RameshKumar ,AP/MECH

Session FN: 9.00 AM to 12.30 PM & Break: 10.45 AM to 11.00AM

Session AN: 01.15.PM to 04.15 PM & Lunch: 12.30 PM to 01.15 PM

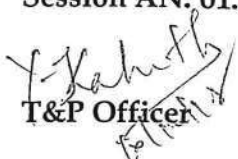

T&P Officer



T&P Coordinator



Principal

- Copy to:
1. All HoDs
 2. Notice Board



PRINCIPAL.
K. S. R. INSTITUTE FOR
ENGINEERING AND TECHNOLOGY,
K. S. R. KALVI NAGAR,
TIRUCHENGODE-637 215,
NAMAKKAL DI. TAMIL NADU.

61

K S R INSTITUTE FOR ENGINEERING AND TECHNOLOGY, Tiruchengode

Training and Placement Cell

Company Specific Internal Training for Sanmar Drive

S. No	Reg No	Name	Branch
1	731615114007	ALEXANDER M	MECH
2	731615114009	ARAVINTHAN P V	MECH
3	731615114010	ARAVINTHASAMY B	MECH
4	731615114021	BHARATHI K N	MECH
5	731615114024	BOOPATHIRAJA S	MECH
6	731615114033	DHINESHRAJ L	MECH
7	731615114051	GOWTHAM K	MECH
8	731615114055	JACKSON P V	MECH
9	731615114098	NISHANTHI B	MECH
10	731615114067	KESAVARAJ M	MECH
11	731615114072	LOGANATHAN K	MECH
12	731615114075	MANIKANDABOOPATHI B	MECH
13	731615114080	MANOJKUMAR P R	MECH
14	731615114110	RAJAMANI M	MECH
15	731615114117	SAI HARISH V	MECH
16	731615114123	SANTHOSH KUMAR R	MECH
17	731615114146	SURYA S C	MECH
18	731615114158	VIGNESH M	MECH
19	731615114161	VIJAY M	MECH
PRESENT			19
ABSENT			-

PRINCIPAL
K. S. R. INSTITUTE FOR
ENGINEERING AND TECHNOLOGY
K. S. R. KALVINAGAR,
TIRUCHENGODE-637 215,
NAMAKKAL DL, TAMIL NADU.

(Approved by AICTE, New Delhi and Affiliated by Anna University, Chennai)

TRAINING AND PLACEMENT CELL

61

Sanmar Drive- Internal Training Programme

Academic year : 2018-2019

Date: 19.12.2018

Student Attendance

S.No	Register No	Name of the Student	19.12.2018	
			FN	AN
1.	731615114007	ALEXANDER M	P	P
2.	731615114008	ARAVINDH P	P	P
3.	731615114010	ARAVINTHASAMY B	P	P
4.	731615114021	BHARATHI K N	P	P
5.	731615114024	BOOPATHIRAJA S	P	P
6.	731615114033	DHINESHRAJ L	P	P
7.	731615114051	GOWTHAM K	P	P
8.	731615114055	JACKSON P V	AB	AB
9.	731615114098	NISHANTHI B	P	P
10.	731615114067	KESAVARAJ M	P	P
11.	731615114072	LOGANATHAN K	P	P
12.	731615114075	MANIKANDABOOPATHI B	AB	AB
13.	731615114080	MANOJKUMAR P R	P	P
14.	731615114110	RAJAMANI M	P	P
15.	731615114117	SAI HARISH V	P	P
16.	731615114123	SANTHOSH KUMAR R	P	P
17.	731615114146	SURYA S C	P	P
18.	731615114158	VIGNESH M	P	P
19.	731615114162	VIJAY P	AB	AB

PRINCIPAL,
K. S. R. INSTITUTE FOR
ENGINEERING AND TECHNOLOGY,
K. S. R. KALVI NAGAR,
TIRUCHENGODE-637 215,
NAMAKKAL Dt, TAMIL NADU.

**K S R INSTITUTE FOR ENGINEERING AND TECHNOLOGY
TIRUCHENGODE – 637 215**

TRAINING PROGRAMME FEEDBACK FORM



Name of the Student: Vignesh M

Branch: Mech

Year / Sem: IV-7

1. Name of the Training : placement

2. Name of the Trainer : Ramesh Kumar

3. Students rating of Trainers : 4/5

S. No.	Date	Subject	Rating (✓)			
			Excellent	Very good	Good	Average
1	19/12/19	Java		✓		

4. Two positive points about the programme:

It was useful

5. Suggestions for improvement:

Need more content

Date: 19/12/19

Vignesh
Signature

**K S R INSTITUTE FOR ENGINEERING AND TECHNOLOGY
TIRUCHENGODE – 637 215**

TRAINING PROGRAMME FEEDBACK FORM



Name of the Student: Vijay M

Branch: Mech

Year / Sem: IV-7

1. Name of the Training :

2. Name of the Trainer : Ramesh Kumar

3. Students rating of Trainers : 4/5

S. No.	Date	Subject	Rating (✓)			
			Excellent	Very good	Good	Average
1	19/12/19	Java		✓		

4. Two positive points about the programme:

It was useful

5. Suggestions for improvement:

Need more content

Date: 19/12/19

PRINCIPAL.
K. S. R. INSTITUTE FOR
ENGINEERING AND TECH.
K. S. R. KALVI NAGAR
TIRUCHENGODE-637 215,
NAMAKKAL DI, TAMIL NADU.



Name of the Student: Surya S Branch: Mech
 Year / Sem: V - 7
 1. Name of the Training : Placement
 2. Name of the Trainer : Ramath Kumar
 3. Students rating of Trainers : 4/5

S. No.	Date	Subject	Rating (√)			
			Excellent	Very good	Good	Average
1	19/12/18	Java		✓		

4. Two positive points about the programme:

It was useful

5. Suggestions for improvement:

Need more content

Date: 19/12/18

[Signature]
Signature



Name of the Student: Raja Mani Branch: Mech
 Year / Sem: V - 7
 1. Name of the Training : Placement
 2. Name of the Trainer : Ramesh Kumar
 3. Students rating of Trainers : 4/5

S. No.	Date	Subject	Rating (√)			
			Excellent	Very good	Good	Average
1	19/12/18	Java		✓		

4. Two positive points about the programme:

It was useful

5. Suggestions for improvement:

Need more content

Date: 19/12/18

[Signature]
PRINCIPAL
K. S. R. INSTITUTE FOR
ENGINEERING
Signature



Ref: KSRIET/T&P/CIR/2018-19

Date: 07.12.2018

This is to inform that all the HoD's and Faculty members that the II year Internal Technical Training (Module I) on C language for ECE, EEE & MECH students & Java Language for CSE & IT Students for the academic year 2018 - 2019 (Even Semester) has been scheduled. All the registered students should attend the Training Programme without fail. If any student skips this Training Programme without proper permission from the respective HoDs, he / she will not be permitted for any further Training Programme and campus recruitment process. Proper Dress Code is mandatory.

Encl.

Training Schedule.

T&P OFFICER
7/12/18

8/12/18
T&P COORDINATOR

PRINCIPAL

Copy to:

1. All HoDs
2. Notice Board

PRINCIPAL.
K. S. R. INSTITUTE FOR
ENGINEERING AND TECHNOLOGY,
K. S. R. KALVI NAGAR,
TIRUCHENGODE-637 215,
NAMAKKAL DI, TAMIL NADU.

K S R INSTITUTE FOR ENGINEERING AND TECHNOLOGY, Tiruchengode

Training and Placement Cell

Softskill Training Programme - EEE

BATCH : 2017 - 2021

Academic Year: 2018 - 2019

Training Date		
S. No	Reg No	Name
1	731617105001	ARUL M
2	731617105002	ASHA R
3	731617105003	BALAJI S
4	731617105004	BHARATH S
5	731617105005	DINESH C
6	731617105006	DINESH KUMAR T
7	731617105007	EZHILAN T
8	731617105008	GOWTHAM S P
9	731617105009	GUGANESH R
10	731617105010	HARI S R
11	731617105011	HEMALATHA S
12	731617105012	JAYASURYA K
13	731617105013	JEEVANANDAM T
14	731617105014	JEEVITHA G
15	731617105015	JEGATHKUMAR S
16	731617105016	KAMALAHASAN G
17	731617105017	KARTHIKEYAN M
18	731617105018	KAVINKUMAR M
19	731617105019	KAVIN MUTHU KUMAR S
20	731617105020	KIRUBAKAR S
21	731617105021	LOGESWARAN C
22	731617105022	MANJUPRIYA M
23	731617105023	MANOJ KUMAR S
24	731617105024	MOHAN T
25	731617105025	NANDAKUMAARAN S
26	731617105027	PARAMASIVAM R
27	731617105028	PERARIVU EZHIL ARASAN T
28	731617105029	POOVARASAN J
29	731617105030	PRASATH S
30	731617105031	PRAVEEN KUMAR A
31	731617105033	RAJAT KUMAR
32	731617105034	RAMYA A
33	731617105035	RAMYA P
34	731617105036	SAKTHIVEL P
35	731617105037	SANTHOSHKUMAR K
36	731617105038	SARANSARVESH M
37	731617105040	SASIKUMAR C

PRINCIPAL.
K. S. R. INSTITUTE FOR
ENGINEERING AND TECHNOLOGY,
K. S. R. KALVI NAGAR,
TIRUCHENGODE-637 215,
NAMAKKAL Dt, TAMIL NADU.

Module No:			1	
Training Date			19/12/18	
S. No		Name	FN	AN
1	731617106002	ABINAYA T	l	l
2	731617106003	ALKA P	l	l
3	731617106004	ANBAZHAGAN K	A	A
4	731617106006	BALAKUMARAN N	/	/
5	731617106007	BOOMA V	/	/
6	731617106008	DARANIDARAN R S	/	/
7	731617106010	DHANISH V	/	/
8	731617106011	DHANUSHKODI N	/	/
9	731617106012	DHARNISH K	A	A
10	731617106013	DHARSHAN T K	/	/
11	731617106014	DINESH U G	/	/
12	731617106015	DINNESH P	A	A
13	731617106016	GEETHARANI G	l	l
14	731617106017	GOKULNATH N	/	/
15	731617106018	GOKULNATH R	/	/
16	731617106019	GOWTHAM M	A	A
17	731617106020	HARI HARA SUDHAN R	/	/
18	731617106021	HARIKRISHNAN M	A	A
19	731617106022	HARISHKUMAR R	/	/
20	731617106023	HEMAHARINI S	/	/
21	731617106024	HEMALATHA S	/	/
22	731617106025	JANARTH S	/	/
23	731617106027	JAWAHAR RAJA P	A	A
24	731617106028	KAMALESHWARAN R	/	/
25	731617106029	KAMALINI N	/	/
26	731617106030	KARTHIKA C	/	/
27	731617106031	KEERTHANA S	/	/
28	731617106032	KEERTHIVASAN N	l	l
29	731617106033	KISHOR M	/	/
30	731617106034	KISHORE D	/	/
31	731617106035	LAKSHMANAN S	/	/
32	731617106036	MADHANGOPAL C	/	/
33	731617106037	MANIMALA R	/	/
34	731617106038	MANJULA T	/	/
35	731617106039	MERINKUMAR L	/	/
36	731617106040	MUSHIDHA SIFANA T	A	A
37	731617106041	MUTHULAKSHMI S	l	/

PRINCIPAL.
K. S. R. INSTITUTE FOR
ENGINEERING AND TECHNOLOGY,
K. S. R. KALVI NAGAR,
TIRUCHENGODE 637 215,
NAMAKKAL Dt. TAMIL NADU.

S.No		Name	FN	AN
38	731617106701	ARAVINTH	1	1
PRESENT			28	28
ABSENT			7	7
PERMISSION			2	2
OD			-	-



PRINCIPAL,
 K. S. R. INSTITUTE FOR
 ENGINEERING AND TECHNOLOGY,
 K. S. R. KALVI NAGAR,
 TIRUCHENGODE-637 215,
 NAMAKKAL DI, TAMIL NADU.

K S R INSTITUTE FOR ENGINEERING AND TECHNOLOGY, Tiruchengode

Training and Placement Cell

CSE - Internal Java language Training Attendance

BATCH : 2017 - 2021

Academic Year: 2018 - 2019

Module No:			1	
Training Date			28/12/18	
S. No	Reg No	Name	FN	AN
1	731617104001	ABINAYA S	/	/
2	731617104002	AGILAN R	/	/
3	731617104004	ARUN KUMAR N	/	/
4	731617104005	BABU R	/	/
5	731617104006	BOOPALAN V	/	/
6	731617104007	CHOWMIYA S B	/	/
7	731617104008	DEEPAK KUMAR J	/	/
8	731617104009	DERIL CHARLESS K	/	/
9	731617104010	DHARSHINI P	/	/
10	731617104012	DINESHKUMAR K (25-02-2000)	/	/
11	731617104013	ELANGO M	/	/
12	731617104014	GAYATHIRI M (19-05-2000)	/	/
13	731617104015	GAYATHIRI M (19-10-2000)	/	/
14	731617104016	GOWTHAM G	/	/
15	731617104017	GUNA M	/	/
16	731617104018	HARIHARAN S	/	/
17	731617104019	HARI KUMAR S	/	/
18	731617104020	HARISH P	/	/
19	731617104021	KAILASH K	/	/
20	731617104022	KARTHIKEYAN S	/	/
21	731617104023	KESAVAN S	/	/
22	731617104024	KISHOR P	/	/
23	731617104025	KOTEESHWARAN P N	/	/
24	731617104026	KRISHNAMOORTHY S	a	a
25	731617104027	MANORANJITH M	a	a
26	731617104028	MARIMUTHU R	/	/
27	731617104029	MENAGA T	/	/
28	731617104030	MOHAMED ABI VAKAAS S	/	/
29	731617104031	MOHANAPREYA N	/	/
30	731617104032	MONISH D	a	a
31	731617104033	MURALIDHARAN A	/	/
32	731617104034	POOJA M	/	/
33	731617104035	POOJA SHREE K	/	/
34	731617104036	POOVARASAN S	/	/
35	731617104037	PRAKASH V	/	/
36	731617104038	PRASANTH N	/	/
37	731617104039	PRASANTH T	/	/

PRINCIPAL,
K. S. R. INSTITUTE FOR
ENGINEERING AND TECHNOLOGY,
K. S. R. KALVI NAGAR,
TIRUCHENGODE-637 215,
NAMAKKAL Dt. TAMIL NADU.

S. No	Reg No	Name	FN	AN
38	731617104040	PURUSOTHAMAN R	/	/
39	731617104041	RAJA SARAVANAN N S	/	/
40	731617104042	SANGEETHA M	/	/
41	731617104043	SANTHOSHKUMAR A	/	/
42	731617104044	SATHEESHKUMAR THANGAVEL	/	/
43	731617104045	SHARMILA A	/	/
44	731617104046	SNEHA P	/	/
45	731617104047	SOUNDHAR P	/	/
46	731617104048	SURYA K	a	a
47	731617104050	VAISHNAVI V	/	/
48	731617104051	VALENTEENA COLLINS J P	/	/
49	731617104052	VEERALAKSHMI S	/	/
50	731617104053	VIGNESH M	/	/
51	731617104054	VIGNESH S	/	/
52	731617104055	VIJAY S	/	/
53	731617104057	YOKESH E	/	/
54	731617104058	YUVASHREE R	/	/
PRESENT			50	50
ABSENT			4	4
PERMISSION			-	-
OD			-	-

 PRINCIPAL.
 K. S. R. INSTITUTE FOR
 ENGINEERING AND TECHNOLOGY,
 K. S. R. KALVI NAGAR
 TIRUCHENGODE-637 215,
 NAMAKKAL DI, TAMIL NADU.

Module No:			1	
Training Date			21/12/18	
S. No		Name	FN	AN
1	731617106042	NAVEEN L	a	a
2	731617106043	NAVEEN S S	/	/
3	731617106045	PARKAVI P	/	/
4	731617106046	PARKAVI S	/	/
5	731617106047	PAVITHRA T	/	/
6	731617106048	PREMELA R	/	/
7	731617106049	PRIYA R	/	/
8	731617106050	PRIYANKA V	/	/
9	731617106051	RAGHURAMACHANDIRAN V	/	/
10	731617106052	RAMYA S	/	/
11	731617106053	RANJITH M	/	/
12	731617106054	RESHMA K	a	a
13	731617106055	RUBAN PRASAD J	/	/
14	731617106056	SANDHIYA K	/	/
15	731617106057	SANTHIYA T	a	a
16	731617106058	SANTHIYA Y	/	/
17	731617106059	SANTHOSH K	/	/
18	731617106060	SHALINI V	/	/
19	731617106061	SHANMATHI M M	l	l
20	731617106062	SHARUMATHI S	/	/
21	731617106063	SINDUJA K	/	/
22	731617106064	SIVASANKARAN K	/	/
23	731617106065	SOFIA A	/	/
24	731617106066	SOWMIYA G V	/	/
25	731617106067	SREEMATHI G	/	/
26	731617106068	SRIDHARAN M	/	/
27	731617106069	SRINIVASAN A	/	/
28	731617106070	SRINIVASAN S R	/	/
29	731617106071	SRI RANJANI S	/	/
30	731617106073	SUBASH K	/	/
31	731617106074	SUDHA G	a	a
32	731617106075	SUKHESAN C	/	/
33	731617106076	SURESH K	/	/
34	731617106077	SURYAPRIYA K	/	/
35	731617106078	SUSHMITHA A	/	/
36	731617106079	SWEETLIN JOSHVA A	/	/
37	731617106080	SWETHA G P	/	/

PRINCIPAL.
K. S. R. INSTITUTE FOR
ENGINEERING AND TECHNOLOGY,
K. S. R. KALVI NAGAR
TIRUCHENGODE-637 015,
NAMAKKAL Dt. TAMIL NADU.

S.No		Name	FN	AN
38	731617106081	TAMILZHAGAN G	/	/
39	731617106082	TEJASWINI S	/	/
40	731617106083	THARUN KUMAR K	/	/
41	731617106084	THIYAGU M	/	/
42	731617106085	UDAYAKUMAR R	/	/
43	731617106086	YASODHA P	/	/
44	731617106087	YUVANSANKAR K	2	2
45	731617106088	ZUBAIR M	/	/
PRESENT			39	39
ABSENT			4	4
PERMISSION			2	2
OD			-	-

 PRINCIPAL
 K. S. R. INSTITUTE FOR
 ENGINEERING AND TECHNOLOGY
 K. S. R. KALVINETRA
 TIRUCHENGODE-6.
 NAMAKKAL DI, TAMIL NADU.

Module No:			1	
Training Date			18/12/18	
S. No	Reg No	Name	FN	AN
1	731617105001	ARUL M	/	/
2	731617105002	ASHA R	/	/
3	731617105003	BALAJI S	/	/
4	731617105004	BHARATH S	/	/
5	731617105005	DINESH C	/	/
6	731617105006	DINESH KUMAR T	/	/
7	731617105008	GOWTHAM S P	/	/
8	731617105009	GUGANESH R	/	/
9	731617105010	HARI S R	/	/
10	731617105011	HEMALATHA S	/	/
11	731617105012	JAYASURYA K	h	h
12	731617105013	JEEVANANDAM T	/	/
13	731617105014	JEEVITHA G	/	/
14	731617105015	JEGATHKUMAR S	/	/
15	731617105016	KAMALAHASAN G	/	/
16	731617105017	KARTHIKEYAN M	/	/
17	731617105018	KAVINKUMAR M	/	/
18	731617105019	KAVIN MUTHU KUMAR S	/	/
19	731617105020	KIRUBAKAR S	/	/
20	731617105021	LOGESWARAN C	/	/
21	731617105022	MANJUPRIYA M	h	h
22	731617105023	MANOJ KUMAR S	a	a
23	731617105024	MOHAN T	/	/
24	731617105025	NANDAKUMAARAN S	/	/
25	731617105027	PARAMASIVAM R	/	/
26	731617105028	PERARIVU EZHIL ARASAN T	/	/
27	731617105029	POOVARASAN J	/	/
28	731617105031	PRAVEEN KUMAR A	/	/
29	731617105032	PRAVEEN KUMAR M	/	/
30	731617105033	RAJAT KUMAR	/	/
31	731617105034	RAMYA A	/	/
32	731617105035	RAMYA P	/	/
33	731617105036	SAKTHIVEL P	/	/
34	731617105037	SANTHOSHKUMAR K	/	/
35	731617105038	SARANSARVESH M	/	/
36	731617105040	SASIKUMAR C	/	/

PRINCIPAL,
K. S. R. INSTITUTE FOR
ENGINEERING AND TECHNOLOGY,
K. S. R. KALVI NAGER
TIRUCHENGODE - 613 005,
NAMAKKAL Dt. Tamil Nadu.

S. No	Reg No	Name	FN	AN
37	731617105041	SELVAM B	1	1
38	731617105042	SHAMEER S	1	1
39	731617105043	SHARMILAPRIYA S	1	1
40	731617105044	SHYAM PRASHAD S	1	1
41	731617105045	SILAMBARASAN S	1	1
42	731617105046	SUJITH S (11-02-2000)	1	1
43	731617105047	SUJITH S (11-07-2000)	1	1
44	731617105048	SUPRIYA K	1	1
45	731617105049	SURESH P	1	1
46	731617105050	SURYA P	1	1
47	731617105052	THAMIZHSELVAN R	1	1
48	731617105053	VALLARASU S	a	a
49	731617105054	VENKATESAN M	1	1
50	731617105055	VINOTH KUMAR R	a	a
PRESENT			45	45
ABSENT			3	3
PERMISSION			2	2
OD			-	-
NOT INTEREST			-	-

PRINCIPAL.
K. S. R. INSTITUTE FOR
ENGINEERING AND TECHNOLOGY,
K. S. R. KALVI NAGAR,
TIRUCHENGODE-637 215,
NAMAKKAL Dt, TAMIL NADU.

Module No:			1	
Trainng Date			26/12/18	
S. No	Reg No	Name	FN	AN
1	731617205001	AJAY SRIRAM K	/	/
2	731617205002	ARULMOZHI M	/	/
3	731617205003	BABU U S	/	/
4	731617205004	BALAMURUGAN S	/	/
5	731617205005	CHANDRU M	/	/
6	731617205006	DHANUSH ADIT R	/	/
7	731617205007	DHINAKARAN B	a	a
8	731617205008	DINESH KUMAR P	/	/
9	731617205010	GIRINATH S	/	/
10	731617205011	GOBIKA M	/	/
11	731617205012	GOKULAN S	/	/
12	731617205013	HARIPRASATH K	/	/
13	731617205014	JESSICA COLLINS J P	/	/
14	731617205015	JOSHUA DANIEL B	a	a
15	731617205016	JOTHEESWARAN R	a	a
16	731617205018	KALIDASS R	/	/
17	731617205019	KANNAN P	/	/
18	731617205021	KARTHIK T	/	/
19	731617205022	KARTHIKEYAN M	a	a
20	731617205024	KEERTHIVARMA K S	/	/
21	731617205025	LAKSHMANAN R	/	/
22	731617205026	MANIKANDAN A	/	/
23	731617205027	MOUNISH G	/	/
24	731617205028	MUKESH KANNA R	/	/
25	731617205030	NANDHINI S	/	/
26	731617205031	NATHIYA V	/	/
27	731617205032	NAVEEN KUMAR G (30-12-1999)	/	/
28	731617205033	NAVEEN KUMAR G (14-06-2000)	/	/
29	731617205034	NIRMAL KUMAR S	/	/
30	731617205035	PAVITHRA S	/	/
31	731617205036	PRIYADHARSHINI P	/	/
32	731617205037	RAGU G	a	a
33	731617205038	RAJARAVEENDHAR G R	/	/
34	731617205039	SAANTHOSHBALAJI S N	a	a
35	731617205040	SANDHIYA G	/	/
36	731617205041	SANTHOSH KUMAR R	/	/
37	731617205042	SARAN V	/	/

S. No	Reg No	Name	FN	AN
38	731617205043	SATHAM M	1	1
39	731617205044	SATHISHKUMAR V	1	1
40	731617205045	SELVAMALAR P	a	a
41	731617205046	SHAILAA P M	1	1
42	731617205047	SHIVANI N	1	1
43	731617205048	SIVASANKARI R	1	1
44	731617205049	SREEMATHI INDRA S	1	1
45	731617205050	SRIRAM S	1	1
46	731617205051	THANESSHWARAN Y G	1	1
47	731617205052	THUSMEENA K R	1	1
48	731617205053	VENKATESHWARAN S	1	1
49	731617205054	VIMALRAJ G	1	1
50	731617205055	VINOTHINI R	1	1
51	731617205701	ASHOK KUMAR S	1	1
PRESENT			44	44
ABSENT			7	7
PERMISSION			-	-
OD			-	-

PRINCIPAL,
K. S. R. INSTITUTE FOR
ENGINEERING AND TECHNOLOGY,
K. S. R. KALVI NAGAR,
TIRUCHENGODE-637 215,
NAMAKKAL DL, TAMIL NADU.

Module No:			1	
Training Date			12/12/2018	
S. No	Reg No	Name	FN	AN
1	731617114058	MOHANARAJ C	/	/
2	731617114059	MONISH KANNA M	P	P
3	731617114060	MUNESWARAN D	/	/
4	731617114061	NANDHAKUMAR G	/	/
5	731617114062	NARESH M	/	/
6	731617114063	NAVEEN M	/	/
7	731617114064	NAVEEN V	/	/
8	731617114065	NIKHIL S	/	/
9	731617114066	NITHISH M	/	/
10	731617114067	PAVITHRAN G	/	/
11	731617114069	PRADEEP N	/	/
12	731617114070	PRADHAP R	/	/
13	731617114071	PRAGATHEESWAR E	/	/
14	731617114072	PRASATH R	/	/
15	731617114073	PRATHIYUMANAN M	/	/
16	731617114074	PRAVEEN H	a	a
17	731617114075	PRAVEENKUMAR V	/	/
18	731617114076	PRAVEEN KUMAR S	/	/
19	731617114077	PREMRAJ S	/	/
20	731617114078	RAHUL V	/	/
21	731617114079	RAMKUMAR B	/	/
22	731617114080	RANJITHKUMAR K	/	/
23	731617114081	SABARINATHAN S	/	/
24	731617114082	SAKTHIVEL P	a	a
25	731617114083	SANTHOSHKUMAR G	/	/
26	731617114085	SARATH KUMAR M	/	/
27	731617114086	SARAVANAA M	/	/
28	731617114087	SARAVANAN R	/	/
29	731617114088	SASIKARAN S	/	/
30	731617114089	SATHISHKUMAR S	/	/
31	731617114090	SHAJAHAN S	P	P
32	731617114091	SRIDHAR C	/	/
33	731617114092	SRIDHARAN R	/	/
34	731617114093	SURENDHAR P	/	/
35	731617114094	SURESHKUMAR A	/	/
36	731617114095	SURESHMOORTHY P	/	/
37	731617114096	SURYAMOORTHY R	/	/

PRINCIPAL,
K. S. R. INSTITUTE FOR
ENGINEERING AND TECHNOLOGY,
K. S. R. KALVI NAGAR,
TIRUCHENGODE-637 215,
NAMAKKAL Dt, TAMIL NADU.

Trainng Date				
S. No	Reg No	Name	FN	AN
38	731617114098	TAMILSELVAN V	/	/
39	731617114099	THAMIL SELVAM B	/	/
40	731617114100	THIRUPATHI M	/	/
41	731617114101	THULASI RAMAN R	/	/
42	731617114102	VIGNESH R	/	/
43	731617114103	VIGNESHWARAN S	/	/
44	731617114104	VIJAYAKUMAR C	/	/
45	731617114105	VINITH D	/	/
46	731617114106	VINOTH KUMAR T	/	/
47	731617114107	YASWANTHKARTHIK S	/	/
48	731617114108	YOGESH N	P	P
49	731617114301	R. Abhishek	/	/
50	731617114302	Dineshwaran	/	/
51	731617114303	M.Hariprasad	/	/
52	731617114304	E.Kannan	/	/
53	731617114305	V.Manikandan	/	/
54	731617114306	Nantha kumar	/	/
PRESENT			49	49
ABSENT			2	2
PERMISSION			-	-
OD			3	3

PRINCIPAL.
K. S. R. INSTITUTE FOR
ENGINEERING AND TECHNOLOGY,
K. S. R. KALVI NAGAR
TIRUCHENGODE-637 215,
NAMAKKAL Dt, TAMIL NADU.

Module No:			1	
Trainng Date			11/12/2018	
S. No	Reg No	Name	FN	AN
1	731617114001	AADHI VISHWANATH M	/	/
2	731617114002	AJITH R	/	/
3	731617114003	ARAVIND S R	/	/
4	731617114004	ARUNESH J	/	/
5	731617114005	ARUN KUMAR S	/	/
6	731617114006	ARUN KUMAR T	/	/
7	731617114007	ARUN PRABAKARAN J	/	/
8	731617114008	ASWANTH KUMAR K	/	/
9	731617114009	ASWIN M	/	/
10	731617114010	BALAJI S	/	/
11	731617114011	BHAGAVATHI PERUMAL G	/	/
12	731617114012	BHARANIDHARAN R	/	/
13	731617114013	BOOPATHI S	/	/
14	731617114014	BOOPATHIRAJA M	/	/
15	731617114015	BUVANESVARAN S	/	/
16	731617114016	CHANDRU K	/	/
17	731617114017	CHANDRU M	/	/
18	731617114018	CHANDRU S	/	/
19	731617114019	DEEPAK K	/	/
20	731617114020	DHARANKUMAR S	/	/
21	731617114021	DHARSHAN C M	/	/
22	731617114022	DINESHKUMAR D	/	/
23	731617114023	DINESHKUMAR R	/	/
24	731617114026	GOBIRAJ R	/	/
25	731617114027	GOKULNATH K	/	/
26	731617114028	GOKULPRASANTH M	a	a
27	731617114029	GOKULRAJ B	/	/
28	731617114030	GOVINDHARASU R	/	/
29	731617114031	GOWTHAM KUMAR T	/	/
30	731617114032	GUNASEELAN C	/	/
31	731617114033	HARIHARAN G	/	/
32	731617114035	HARIPRASATH P	/	/
33	731617114036	HARIRAM B	a	a
34	731617114037	INDIRAJITH M	/	/
35	731617114038	JAGATHESHWARAN N	/	/
36	731617114039	KMALESH T	/	/
37	731617114040	KARTHICK R	/	/

PRINCIPAL,
K. S. R. INSTITUTE FOR
ENGINEERING AND TECHNOLOGY,
K. S. R. KALVI NAGAR,
TIRUCHENGODE - 615 015,
NAMAKKAL Dt. Tamil Nadu.

S. No	Reg No	Name	FN	AN
38	731617114041	KARTHIK A S	/	/
39	731617114042	KARTHIKEYAN S	/	/
40	731617114043	KARTHIKEYAN T	/	/
41	731617114044	KARUPPAIAH K	/	/
42	731617114045	KATHIRVEL M	/	/
43	731617114046	KAVIN M	/	/
44	731617114047	KAVIN M	/	/
45	731617114048	KAVINKUMAR C	/	/
46	731617114049	KAVIRAJ M	/	/
47	731617114050	KIRUBAKARAN K	/	/
48	731617114051	KIRUBAKARAN K	/	/
49	731617114052	LOGESH M	/	/
50	731617114053	MADESH K	/	/
51	731617114054	MANIKANDAN R	/	/
52	731617114055	MANOJ N	/	/
53	731617114056	MEIYANANDHAN V	/	/
54	731617114057	MOHAMED ABBAS M	/	/
PRESENT			52	52
ABSENT			2	2
PERMISSION			+	-
OD			-	-

PRINCIPAL,
K. S. R. INSTITUTE FOR
ENGINEERING AND TECHNOLOGY,
K. S. R. KALVI NAGAR,
TIRUCHENGODE-637 215,
NAMAKKAL DT, TAMIL NADU.

K S R INSTITUTE FOR ENGINEERING AND TECHNOLOGY, Tiruchengode

Training and Placement Cell

Softskill Training Programme - MECH A

BATCH : 2017 - 2021

Academic Year: 2018 - 2019

S. No	Reg No	Name
1	731617114001	AADHI VISHWANATH M
2	731617114002	AJITH R
3	731617114003	ARAVIND S R
4	731617114004	ARUNESH J
5	731617114005	ARUN KUMAR S
6	731617114006	ARUN KUMAR T
7	731617114007	ARUN PRABAKARAN J
8	731617114008	ASWANTH KUMAR K
9	731617114009	ASWIN M
10	731617114010	BALAJI S
11	731617114011	BHAGAVATHI PERUMAL G
12	731617114012	BHARANIDHARAN R
13	731617114013	BOOPATHI S
14	731617114014	BOOPATHIRAJA M
15	731617114015	BUVANESVARAN S
16	731617114016	CHANDRU K
17	731617114017	CHANDRU M
18	731617114018	CHANDRU S
19	731617114019	DEEPAK K
20	731617114020	DHARANKUMAR S
21	731617114021	DHARSHAN C M
22	731617114022	DINESHKUMAR D
23	731617114023	DINESHKUMAR R
24	731617114024	DIVAGAR S
25	731617114026	GOBIRAJ R
26	731617114027	GOKULNATH K
27	731617114028	GOKULPRASANTH M
28	731617114029	GOKULRAJ B
29	731617114030	GOVINDHARASU R
30	731617114031	GOWTHAM KUMAR T
31	731617114032	GUNASEELAN C
32	731617114033	HARIHARAN G
33	731617114034	HARIHARAN PR
34	731617114035	HARIPRASATH P
35	731617114036	HARIRAM B
36	731617114037	INDIRAJITH M
37	731617114038	JAGATHESHWARAN N
38	731617114039	KAMALESH T
39	731617114040	KARTHICK R

K. S. R. INSTITUTE FOR
ENGINEERING AND TECHNOLOGY,
K. S. R. KALVI NAGAR,
TIRUCHENGODE-637 215,
NAMAKKAL Dt. TAMIL NADU.

S. No	Reg No	Name
40	731617114041	KARTHIK A S
41	731617114042	KARTHIKEYAN S
42	731617114043	KARTHIKEYAN T
43	731617114044	KARUPPAIAH K
44	731617114045	KATHIRVEL M
45	731617114046	KAVIN M
46	731617114047	KAVIN M
47	731617114048	KAVINKUMAR C
48	731617114049	KAVIRAJ M
49	731617114050	KIRUBAKARAN K
50	731617114051	KIRUBAKARAN K
51	731617114052	LOGESH M
52	731617114053	MADESH K
53	731617114054	MANIKANDAN R
54	731617114055	MANOJ N
55	731617114056	MEIYANANDHAN V
56	731617114057	MOHAMED ABBAS M

PRINCIPAL,
K. S. R INSTITUTE FOR
ENGINEERING AND TECHNOLOGY,
K. S. R KALVI NAGAR,
TIRUCHENGODE -637 215,
NAMAKKAL DI, TAMIL NADU.

K S R INSTITUTE FOR ENGINEERING AND TECHNOLOGY, Tiruchengode

Training and Placement Cell

Softskill Training Programme - ECE B

BATCH : 2017 - 2021

Academic Year: 2018 - 2019

S. No		Name
1	731617106042	NAVEEN L
2	731617106043	NAVEEN S S
3	731617106045	PARKAVI P
4	731617106046	PARKAVI S
5	731617106047	PAVITHRA T
6	731617106048	PREMELA R
7	731617106049	PRIYA R
8	731617106050	PRIYANKA V
9	731617106051	RAGHURAMACHANDIRAN V
10	731617106052	RAMYA S
11	731617106053	RANJITH M
12	731617106054	RESHMA K
13	731617106055	RUBAN PRASAD J
14	731617106056	SANDHIYA K
15	731617106057	SANTHIYA T
16	731617106058	SANTHIYA Y
17	731617106059	SANTHOSH K
18	731617106060	SHALINI V
19	731617106061	SHANMATHI M M
20	731617106062	SHARUMATHI S
21	731617106063	SINDUJA K
22	731617106064	SIVASANKARAN K
23	731617106065	SOFIA A
24	731617106066	SOWMIYA G V
25	731617106067	SREEMATHI G
26	731617106068	SRIDHARAN M
27	731617106069	SRINIVASAN A
28	731617106070	SRINIVASAN S R
29	731617106071	SRI RANJANI S
30	731617106073	SUBASH K
31	731617106074	SUDHA G
32	731617106075	SUKHESAN C
33	731617106076	SURESH K
34	731617106077	SURYAPRIYA K
35	731617106078	SUSHMITHA A
36	731617106079	SWEETLIN JOSHVA A
37	731617106080	SWETHA G P
38	731617106081	TAMILZHAGAN G
39	731617106082	TEJASWINI S

PRINCIPAL,
K. S. R. INSTITUTE FOR
ENGINEERING AND TECHNOLOGY,
K. S. R. KALVI NAGAR,
TIRUCHENGODE-637 215,
NAMAKKAL Dt, TAMIL NADU.

S.No		Name
40	731617106084	THIYAGU M
41	731617106085	UDAYAKUMAR R
42	731617106086	YASODHA P
43	731617106087	YUVANSANKAR K
44	731617106088	ZUBAIR M



PRINCIPAL,
K. S. R. INSTITUTE FOR
ENGINEERING AND TECHNOLOGY
K. S. R. KALVINODGAR,
TIRUCHENGODE-621 215,
NAMAKKAL DISTRICT, TAMIL NADU.

K S R INSTITUTE FOR ENGINEERING AND TECHNOLOGY, Tiruchengode

Training and Placement Cell

Softskill Training Programme - MECH B

BATCH : 2017 - 2021

Academic Year: 2018 - 2019

S. No	Reg No	Name
1	731617114058	MOHANARAJ C
2	731617114059	MONISH KANNA M
3	731617114060	MUNESWARAN D
4	731617114061	NANDHAKUMAR G
5	731617114062	NARESH M
6	731617114063	NAVEEN M
7	731617114064	NAVEEN V
8	731617114065	NIKHIL S
9	731617114066	NITHISH M
10	731617114067	PAVITHRAN G
11	731617114068	PRABU J
12	731617114069	PRADEEP N
13	731617114070	PRADHAP R
14	731617114071	PRAGATHEESWAR E
15	731617114072	PRASATH R
16	731617114073	PRATHIYUMANAN M
17	731617114074	PRAVEEN H
18	731617114075	PRAVEENKUMAR V
19	731617114076	PRAVEEN KUMAR S
20	731617114077	PREMRAJ S
21	731617114078	RAHUL V
22	731617114079	RAMKUMAR B
23	731617114080	RANJITHKUMAR K
24	731617114081	SABARINATHAN S
25	731617114082	SAKTHIVEL P
26	731617114083	SANTHOSHKUMAR G
27	731617114084	SARAN KUMAR D
28	731617114085	SARATH KUMAR M
29	731617114086	SARAVANAA M
30	731617114087	SARAVANAN R
31	731617114088	SASIKARAN S
32	731617114089	SATHISHKUMAR S
33	731617114090	SHAJAHAN S
34	731617114091	SRIDHAR C
35	731617114092	SRIDHARAN R
36	731617114093	SURENDHAR P
37	731617114094	SURESHKUMAR A
38	731617114095	SURESHMOORTHY P
39	731617114096	SURYAMOORTHY R

PRINCIPAL,
K. S. R. INSTITUTE FOR
ENGINEERING AND TECHNOLOGY,
K. S. R. KALVINAGAR,
TIRUCHENGODE-637 215,
NAMAKKAL DISTRICT, TAMIL NADU.

S. No	Reg No	Name
40	731617114098	TAMILSELVAN V
41	731617114099	THAMIL SELVAM B
42	731617114100	THIRUPATHI M
43	731617114101	THULASI RAMAN R
44	731617114102	VIGNESH R
45	731617114103	VIGNESHWARAN S
46	731617114104	VIJAYAKUMAR C
47	731617114105	VINITH D
48	731617114106	VINOTH KUMAR T
49	731617114107	YASWANTHKARTHIK S
50	731617114108	YOGESH N



PRINCIPAL.
K. S. R. INSTITUTE FOR
ENGINEERING AND TECHNOLOGY,
K. S. R. KALVI NAGAR,
TIRUCHENGODE-637 215,
NAMAKKAL Dt, TAMIL NADU.

K S R INSTITUTE FOR ENGINEERING AND TECHNOLOGY,
Tiruchengode - 637215
Training and Placement Cell
Softskill Training Programme - CSE

BATCH : 2017 - 2021

Academic Year: 2018 - 2019

S. No	Reg No	Name
1	731617104001	ABINAYA S
2	731617104002	AGILAN R
3	731617104003	AKKIRAJU SAI CHARAN
4	731617104004	ARUN KUMAR N
5	731617104005	BABU R
6	731617104006	BOOPALAN V
7	731617104007	CHOWMIYA S B
8	731617104008	DEEPAK KUMAR J
9	731617104009	DERIL CHARLESS K
10	731617104010	DHARSHINI P
11	731617104011	DINESHKUMAR K (03-11-1999)
12	731617104012	DINESHKUMAR K (25-02-2000)
13	731617104013	ELANGO M
14	731617104014	GAYATHIRI M (19-05-2000)
15	731617104015	GAYATHIRI M (19-10-2000)
16	731617104016	GOWTHAM G
17	731617104017	GUNA M
18	731617104018	HARIHARAN S
19	731617104019	HARI KUMAR S
20	731617104020	HARISH P
21	731617104021	KAILASH K
22	731617104022	KARTHIKEYAN S
23	731617104023	KESAVAN S
24	731617104024	KISHOR P
25	731617104025	KOTEESHWARAN P N
26	731617104026	KRISHNAMOORTHY S
27	731617104027	MANORANJITH M
28	731617104028	MARIMUTHU R
29	731617104029	MENAGA T
30	731617104030	MOHAMED ABI VAKAAS S
31	731617104031	MOHANAPREYA N
32	731617104032	MONISH D
33	731617104033	MURALIDHARAN A
34	731617104034	POOJA M
35	731617104035	POOJA SHREE K
36	731617104036	POOVARASAN S
37	731617104037	PRAKASH V
38	731617104038	PRASANTH N
39	731617104039	PRASANTH T
40	731617104040	PURUSOTHAMAN R

PRINCIPAL

**K. S. R. INSTITUTE FOR
ENGINEERING AND TECHNOLOGY,
K. S. R. KALVI NAGAR,
TIRUCHENGODE-637 215,
NAMAKKAL Dt. TAMIL NADU.**

S. No	Reg No	Name
41	731617104041	RAJA SARAVANAN N S
42	731617104042	SANGEETHA M
43	731617104043	SANTHOSHKUMAR A
44	731617104044	SATHEESHKUMAR THANGAVEL
45	731617104045	SHARMILA A
46	731617104046	SNEHA P
47	731617104047	SOUNDHAR P
48	731617104048	SURYA K
49	731617104049	TAMILARASU K
50	731617104050	VAISHNAVI V
51	731617104051	VALENTEENA COLLINS J P
52	731617104052	VEERALAKSHMI S
53	731617104053	VIGNESH M
54	731617104054	VIGNESH S
55	731617104055	VIJAY S
56	731617104057	YOKESH E
57	731617104058	YUVASHREE R



PRINCIPAL,
K. S. R. INSTITUTE FOR
ENGINEERING AND TECHNOLOGY,
K. S. R. KALVI NAGAR,
TIRUCHENGODE-637 215,
NAMAKKAL Dt, TAMIL NADU.

K. S. R. INSTITUTE FOR
ENGINEERING AND TECHNOLOGY,
K. S. R. KALVI NAGAR,
TIRUCHENGODE-637 215,
NAMAKKAL Dt, TAMIL NADU.

K S R INSTITUTE FOR ENGINEERING AND TECHNOLOGY, Tiruchengode

Training and Placement Cell

Softskill Training Programme - IT

BATCH : 2017 - 2021

Academic Year: 2018 - 2019

S. No	Reg No	Name
1	731617205001	AJAY SRIRAM K
2	731617205002	ARULMOZHI M
3	731617205003	BABU U S
4	731617205004	BALAMURUGAN S
5	731617205005	CHANDRU M
6	731617205006	DHANUSH ADIT R
7	731617205007	DHINAKARAN B
8	731617205008	DINESH KUMAR P
9	731617205009	DIVYA P
10	731617205010	GIRINATH S
11	731617205011	GOBIKA M
12	731617205012	GOKULAN S
13	731617205013	HARIPRASATH K
14	731617205014	JESSICA COLLINS J P
15	731617205015	JOSHUA DANIEL B
16	731617205016	JOTHEESWARAN R
17	731617205017	KALAI KANNAN S
18	731617205018	KALIDASS R
19	731617205019	KANNAN P
20	731617205021	KARTHIK T
21	731617205022	KARTHIKEYAN M
22	731617205023	KAVIN I G
23	731617205024	KEERTHIVARMA K S
24	731617205025	LAKSHMANAN R
25	731617205026	MANIKANDAN A
26	731617205027	MOUNISH G
27	731617205028	MUKESH KANNA R
28	731617205029	MUKESHKANNAN T
29	731617205030	NANDHINI S
30	731617205031	NATHIYA V
31	731617205032	NAVEEN KUMAR G (30-12-1999)
32	731617205033	NAVEEN KUMAR G (14-06-2000)
33	731617205034	NIRMAL KUMAR S
34	731617205035	PAVITHRA S
35	731617205036	PRIYADHARSHINI P
36	731617205037	RAGU G
37	731617205038	RAJARAVEENDHAR G R
38	731617205039	SAANTHOSHBALAJI S N
39	731617205040	SANDHIYA G

PRINCIPAL.
K. S. R. INSTITUTE FOR
ENGINEERING AND TECHNOLOGY,
K. S. R. KALVI NAGAR,
TIRUCHENGODE-637 215,
NAMAKKAL Dt, TAMIL NADU.

S. No	Reg No	Name
40	731617205041	SANTHOSH KUMAR R
41	731617205042	SARAN V
42	731617205043	SATHAM M
43	731617205044	SATHISHKUMAR V
44	731617205045	SELVAMALAR P
45	731617205046	SHAILAA P M
46	731617205047	SHIVANI N
47	731617205048	SIVASANKARI R
48	731617205049	SREEMATHI INDRA S
49	731617205050	SRIRAM S
50	731617205051	THANESSHWARAN Y G
51	731617205052	THUSMEENA K R
52	731617205053	VENKATESHWARAN S
53	731617205054	VIMALRAJ G
54	731617205055	VINOTHINI R

 PRINCIPAL,
 K. S. R. INSTITUTE FOR
 ENGINEERING AND TECHNOLOGY,
 K. S. R. KALVI NAGAR,
 TIRUCHENGODE - 617 213,
 NAMAKKAL DISTRICT, TAMIL NADU.

K S R INSTITUTE FOR ENGINEERING AND TECHNOLOGY, Tiruchengode

Training and Placement Cell

Softskill Training Programme - ECE A

BATCH : 2017 - 2021

Academic Year: 2018 - 2019

S. No	Reg No	Name
1	731617106001	AARTHI G
2	731617106002	ABINAYA T
3	731617106003	ALKA P
4	731617106004	ANBAZHAGAN K
5	731617106005	ASHWINKUMAR V
6	731617106006	BALAKUMARAN N
7	731617106007	BOOMA V
8	731617106008	DARANIDARAN R S
9	731617106009	DEEPA R
10	731617106010	DHANISH V
11	731617106011	DHANUSHKODI N
12	731617106012	DHARNISH K
13	731617106013	DHARSHAN T K
14	731617106014	DINESH U G
15	731617106015	DINNESH P
16	731617106016	GEETHARANI G
17	731617106017	GOKULNATH N
18	731617106018	GOKULNATH R
19	731617106019	GOWTHAM M
20	731617106020	HARI HARA SUDHAN R
21	731617106021	HARIKRISHNAN M
22	731617106022	HARISHKUMAR R
23	731617106023	HEMAHARINI S
24	731617106024	HEMALATHA S
25	731617106025	JANARTH S
26	731617106026	JANARTHANAN D
27	731617106027	JAWAHAR RAJA P
28	731617106028	KAMALESHWARAN R
29	731617106029	KAMALINI N
30	731617106030	KARTHIKA C
31	731617106031	KEERTHANA S
32	731617106032	KEERTHIVASAN N
33	731617106033	KISHOR M
34	731617106034	KISHORE D
35	731617106035	LAKSHMANAN S
36	731617106036	MADHANGOPAL C
37	731617106037	MANIMALA R
38	731617106038	MANJULA T
39	731617106039	MERINKUMAR L

PRINCIPAL,
K. S. R. INSTITUTE FOR
ENGINEERING AND TECHNOLOGY,
K. S. R. KALVI NAGAR,
TIRUCHENGODE-637 215,
NAMAKKAL Dt. TAMIL NADU.

S. No	Reg No	Name
40	731617106040	MUSHIDHA SIFANA T
41	731617106041	MUTHULAKSHMI S

PRINCIPAL,
K. S. R. INSTITUTE FOR
ENGINEERING AND TECHNOLOGY,
K. S. R. KALVI NAGAR,
TIRUCHENGODE-637 215,
NAMAKKAL DI, TAMIL NADU.

[Faint, illegible handwritten text]

**K S R INSTITUTE FOR ENGINEERING AND TECHNOLOGY
TIRUCHENGODE - 637 215**

TRAINING PROGRAMME FEEDBACK FORM



Name of the Student: Swetha . B Branch: CSE

Year / Sem: IV / 6

1. Name of the Training : Recursion, Tree, Queue, Linked List

2. Name of the Trainer : External Trainer

3. Students rating of Trainers : 4/5

S. No.	Date	Subject	Rating (√)			
			Excellent	Very good	Good	Average
1	20.01.19	Binary tree		✓		

4. Two positive points about the programme:

It was useful
Learn about new things.

5. Suggestions for improvement:

Need more content.

Date: 20.01.19

Swetha
Signature

**K S R INST!TUTE FOR ENGINEERING AND TECHNOLOGY
TIRUCHENGODE - 637 215**

TRAINING PROGRAMME FEEDBACK FORM



Name of the Student: Vasanthini S Branch: CSE

Year / Sem: IV / 6

1. Name of the Training : recursion, tree, Queue linked list

2. Name of the Trainer : External Trainer

3. Students rating of Trainers : 4/5

S. No.	Date	Subject	Rating (√)			
			Excellent	Very good	Good	Average
1	21.01.19	Binary tree		✓		

4. Two positive points about the programme:

It was useful thing about it
Learn new

5. Suggestions for improvement:

need more notes to learn.

Date: 21.01.19

PRINCIPAL,
K. S. R. INSTITUTE FOR
ENGINEERING AND TECHNOLOGY,
K. S. R. KALVI NAGAR,
TIRUCHENGODE-637 215,
NAMAKKAL Dt. TAMIL NADU.

Vasanthini
Signature



Name of the Student: Ohirakilan, R Branch: EEE

Year / Sem: V-1

1. Name of the Training: placement

2. Name of the Trainer: Jagadeesan, P

3. Students rating of Trainers: 4/5

S. No.	Date	Subject	Rating (√)			
			Excellent	Very good	Good	Average
1	3/2/19	Java		✓		

4. Two positive points about the programme:

It was useful

5. Suggestions for improvement:

need for content

Date: 3/2/19

Ohirakilan
Signature



Name of the Student: pharmani, R Branch: EEE

Year / Sem: V-1

1. Name of the Training: placement

2. Name of the Trainer: Jagadeesan, P

3. Students rating of Trainers: 4/5

S. No.	Date	Subject	Rating (√)			
			Excellent	Very good	Good	Average
1	3/2/19	Java		✓		

4. Two positive points about the programme:

It was useful

5. Suggestions for improvement:

need for content

Date: 3/2/19

Pharmani
Signature
PRINCIPAL,
K. S. R. INSTITUTE FOR
ENGINEERING AND TECHNOLOGY,
K. S. R. KALVI NAGAR,
TIRUCHENGODE-637 215,
NAMAKKAL DI, TAMIL NADU.

**K S R INSTITUTE FOR ENGINEERING AND TECHNOLOGY
TIRUCHENGODE - 637 215**

TRAINING PROGRAMME FEEDBACK FORM



Name of the Student: Arth R Branch: Mech-A

Year / Sem: II / 3

1. Name of the Training : Internal C language

2. Name of the Trainer : External Trainer

3. Students rating of Trainers : 4/5

S. No.	Date	Subject	Rating (✓)			
			Excellent	Very good	Good	Average
1	11.12.18	C language		✓		

4. Two positive points about the programme:

*It was useful
learn new things*

5. Suggestions for improvement:

Need more content

Date: 11.12.18

Arth R
Signature

**K S R INSTITUTE FOR ENGINEERING AND TECHNOLOGY
TIRUCHENGODE - 637 215**

TRAINING PROGRAMME FEEDBACK FORM



Name of the Student: Aravind SR Branch: Mech A

Year / Sem: II / 3

1. Name of the Training : Internal C language

2. Name of the Trainer : External Trainer

3. Students rating of Trainers : 4/5

S. No.	Date	Subject	Rating (✓)			
			Excellent	Very good	Good	Average
1	11.12.18	C language		✓		

4. Two positive points about the programme:

*It was useful
learn new ones*

5. Suggestions for improvement:

Need more content

Date: 11.12.18

Aravind SR
PRINCIPAL
K. S. R. INSTITUTE FOR
ENGINEERING AND TECHNOLOGY,
K. S. R. KALV SIGNATURE
TIRUCHENGODE 637 215,
NAMAKKAL Dt. TAMIL NADU.

**K S R INSTITUTE FOR ENGINEERING AND TECHNOLOGY
TIRUCHENGODE - 637 215**

TRAINING PROGRAMME FEEDBACK FORM



Name of the Student: Axul M Branch: EEE

Year / Sem: 1/3

1. Name of the Training : Internal C language
 2. Name of the Trainer : External Trainer
 3. Students rating of Trainers : 4/5

S. No.	Date	Subject	Rating (✓)			
			Excellent	Very good	Good	Average
1	18.12.18	C language		✓		

4. Two positive points about the programme:
It was useful
Learn new one

5. Suggestions for improvement:
Need more content

Date: 18.12.18 Signature: Axul

**K S R INSTITUTE FOR ENGINEERING AND TECHNOLOGY
TIRUCHENGODE - 637 215**

TRAINING PROGRAMME FEEDBACK FORM



Name of the Student: Asha R Branch: EEE

Year / Sem: 1/3

1. Name of the Training :
 2. Name of the Trainer :
 3. Students rating of Trainers :

S. No.	Date	Subject	Rating (✓)			
			Excellent	Very good	Good	Average
1	18.12.18	C language		✓		

4. Two positive points about the programme:
It was useful
Learn new one

5. Suggestions for improvement:
Need more content

Date: 18.12.18 Signature: Asha

PRINCIPAL,
K. S. R. INSTITUTE FOR
ENGINEERING AND TECHNOLOGY,
K. S. R. KALVI NAGAR,
TIRUCHENGODE - 637 215,
NAMAKKAL DT, TAMIL NADU.

**K S R INSTITUTE FOR ENGINEERING AND TECHNOLOGY
TIRUCHENGODE - 637 215**

TRAINING PROGRAMME FEEDBACK FORM



Name of the Student: Mehamajic Branch: Mech-B

Year / Sem: 1/3

1. Name of the Training : Internal C language
 2. Name of the Trainer : External Trainer
 3. Students rating of Trainers : 4/5

S. No.	Date	Subject	Rating (√)			
			Excellent	Very good	Good	Average
1	12.12.18	C language		✓		

4. Two positive points about the programme:

It is useful
Learn new one

5. Suggestions for improvement:

Need more content

Date: 12.12.18

Mahudya
Signature

**K S R INSTITUTE FOR ENGINEERING AND TECHNOLOGY
TIRUCHENGODE - 637 215**

TRAINING PROGRAMME FEEDBACK FORM



Name of the Student: Narashan Branch: Mech B

Year / Sem: 1/3

1. Name of the Training : Internal C language
 2. Name of the Trainer : External Trainer
 3. Students rating of Trainers : 4/5

S. No.	Date	Subject	Rating (√)			
			Excellent	Very good	Good	Average
1	12.12.18	C language		✓		

4. Two positive points about the programme:

It is useful
Learn new one

5. Suggestions for improvement:

Need more content

Date: 12.12.18



Narashan
Signature

PRINCIPAL,
K. S. R. INSTITUTE FOR
ENGINEERING AND TECHNOLOGY,
K. S. R. KALVI NAGAR,
TIRUCHENGODE - 637 215,
NAMAKKAL Dt. TAMIL NADU.

**K S R INSTITUTE FOR ENGINEERING AND TECHNOLOGY
TIRUCHENGODE - 637 215**

TRAINING PROGRAMME FEEDBACK FORM



Name of the Student: Thirumana K R Branch: IT

Year / Sem: II / III

1. Name of the Training: Internal java Language Training

2. Name of the Trainer: Bopal

3. Students rating of Trainers: 5/5

S. No.	Date	Subject	Rating (✓)			
			Excellent	Very good	Good	Average
1	26.12.18	Internal java language	✓			

4. Two positive points about the programme:

GOOD

5. Suggestions for improvement:

Date: 26.12.18

K.R. Thirumana
Signature

**K S R INSTITUTE FOR ENGINEERING AND TECHNOLOGY
TIRUCHENGODE - 637 215**

TRAINING PROGRAMME FEEDBACK FORM



Name of the Student: Shruthi Indras Branch: IT

Year / Sem: II / III

1. Name of the Training: Internal java language

2. Name of the Trainer: Bopal

3. Students rating of Trainers: 4/5

S. No.	Date	Subject	Rating (✓)			
			Excellent	Very good	Good	Average
1	26.12.18	Internal java language		✓		

4. Two positive points about the programme:

EXCELLENT

5. Suggestions for improvement:

Date: 26.12.18

PRINCIPAL,
K. S. R. INSTITUTE FOR
ENGINEERING AND TECHNOLOGY
K. S. R. KALVI NAGAR,
TIRUCHENGODE-637 215.
NAMAKKAL Dt, TAMIL NADU.

Shruthi Indras
Signature

**K S R INSTITUTE FOR ENGINEERING AND TECHNOLOGY
TIRUCHENGODE - 637 215**

TRAINING PROGRAMME FEEDBACK FORM



Name of the Student: David Charles K

Branch: CSE

Year / Sem: II/III

1. Name of the Training: Internal java language training

2. Name of the Trainer: Crapal

3. Students rating of Trainers: 5/5

S. No.	Date	Subject	Rating (✓)			
			Excellent	Very good	Good	Average
1	28-12-18	Internal java language training	✓			

4. Two positive points about the programme:

Excellent teaching

5. Suggestions for improvement:

Date: 28.12.18

[Signature]
Signature

**K S R INSTITUTE FOR ENGINEERING AND TECHNOLOGY
TIRUCHENGODE - 637 215**

TRAINING PROGRAMME FEEDBACK FORM



Name of the Student: Deepak Kumar J

Branch: CSE

Year / Sem: II/III

1. Name of the Training: Crapal Internal java language training

2. Name of the Trainer: Crapal

3. Students rating of Trainers: 4/5

S. No.	Date	Subject	Rating (✓)			
			Excellent	Very good	Good	Average
1	28.12.18	Internal java language training		✓		

4. Two positive points about the programme:

Good for learning

5. Suggestions for improvement:

Date: 28.12.18

PRINCIPAL.
K. S. R. INSTITUTE FOR ENGINEERING AND TECHNOLOGY
K. S. R. KALVI NAGAR,
TIRUCHENGODE-637 215,
NAMAKKAL DI, TAMIL NADU.

**K S R INSTITUTE FOR ENGINEERING AND TECHNOLOGY
TIRUCHENGODE - 637 215**

TRAINING PROGRAMME FEEDBACK FORM



Name of the Student: Ajay Sriram K Branch: IT

Year / Sem: II / CSE

1. Name of the Training: Embedded C
 2. Name of the Trainer: External Trainer
 3. Students rating of Trainers: 4/5

S. No.	Date	Subject	Rating (✓)			
			Excellent	Very good	Good	Average
1	26.12.18	Internal Java		✓		

4. Two positive points about the programme:

IT was useful.

5. Suggestions for improvement:

need more content.

Date: 26.12.18

[Signature]
Signature

**K S R INSTITUTE FOR ENGINEERING AND TECHNOLOGY
TIRUCHENGODE - 637 215**

TRAINING PROGRAMME FEEDBACK FORM



Name of the Student: Amalrajhi M Branch: IT

Year / Sem: II / CSE

1. Name of the Training: Internal Java Language
 2. Name of the Trainer: External Trainer
 3. Students rating of Trainers: 4/5

S. No.	Date	Subject	Rating (✓)			
			Excellent	Very good	Good	Average
1	26.12.18	Internal Java		✓		

4. Two positive points about the programme:

IT was useful.

5. Suggestions for improvement:

need more content.

Date: 26.12.18

PRINCIPAL
 K. S. R. INSTITUTE FOR
 ENGINEERING AND TECHNOLOGY
 K. S. R. KALVINAGAR,
 TIRUCHENGODE - 637 215.
[Signature]
 Signature

**K S R INSTITUTE FOR ENGINEERING AND TECHNOLOGY
TIRUCHENGODE - 637 215**

TRAINING PROGRAMME FEEDBACK FORM



Name of the Student: Alinaya T

Branch: ECE-A

Year / Sem: II / III

1. Name of the Training: INTERNAL LANGUAGE

2. Name of the Trainer: VENKAT

3. Students rating of Trainers: 5/5

S. No.	Date	Subject	Rating (√)			
			Excellent	Very good	Good	Average
1	19.12.18	INTERNAL LANGUAGE	✓			

4. Two positive points about the programme:

VERY GOOD

5. Suggestions for improvement:

Date: 19.12.18

Alinaya T
Signature

**K S R INSTITUTE FOR ENGINEERING AND TECHNOLOGY
TIRUCHENGODE - 637 215**

TRAINING PROGRAMME FEEDBACK FORM



Name of the Student: DINNESH P

Branch: ECE-A

Year / Sem: II / III

1. Name of the Training: VENKAT INTERNAL LANGUAGE

2. Name of the Trainer: VENKAT

3. Students rating of Trainers: 5/5

S. No.	Date	Subject	Rating (√)			
			Excellent	Very good	Good	Average
1	19.12.18	INTERNAL LANGUAGE	✓			

4. Two positive points about the programme:

5. Suggestions for improvement: GOOD

Date: 19.12.18

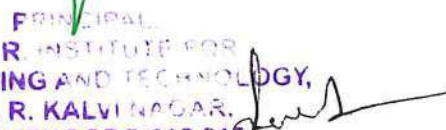
 PRINCIPAL
 K. S. R. INSTITUTE FOR
 ENGINEERING AND TECHNOLOGY,
 K. S. R. KALVINAGAR,
 TIRUCHENGODE-637 215,
 NAMAKKAL Dt, TAMIL NADU. Signature



Name of the Student: Shannathi MM

Branch: ECE-B

Year / Sem: II/IIA

1. Name of the Training: INTERNAL LANGUAGE

2. Name of the Trainer: VENKAT

3. Students rating of Trainers: 5/5

S. No.	Date	Subject	Rating (✓)			
			Excellent	Very good	Good	Average
1	21.12.18	INTERNAL C LANGUAGE	✓			

4. Two positive points about the programme:

GOOD

5. Suggestions for improvement:

Date: 21.12.18

Shannathi
Signature



Name of the Student: RAMYA S

Branch: ECE-B

Year / Sem: II/IIA

1. Name of the Training: INTERNAL CLANGUANE

2. Name of the Trainer: VENKAT

3. Students rating of Trainers: 5/5

S. No.	Date	Subject	Rating (✓)			
			Excellent	Very good	Good	Average
1	21.12.18	INTERNAL C LANGUAGE	✓			

4. Two positive points about the programme:

very good

5. Suggestions for improvement:

Date: 21.12.18

[Signature]
PRINCIPAL,
K. S. R. INSTITUTE FOR
ENGINEERING AND TECHNOLOGY,
K. S. R. KALVI NAGAR,
TIRUCHENGODE-637 215,
NAMAKKAL Dt, TAMIL NADU.

Signature



K S R IET T&P <ksrietplacement@gmail.com>

2020 Batch - Tech Training - Reg.

2 messages

KSR EI <ksreiplacement@gmail.com> Fri, Jan 18, 2019 at 6:46 PM
 To: "Dr. Karthikeyan G PC KSRCT" <ksrctplacement@gmail.com>, Sankar I Placement Officer KSRCE <ksrceplacement@gmail.com>, ksrietplacement <ksrietplacement@gmail.com>
 Cc: "Dr.Kumaravel KSRCT Principal" <principal@ksrct.ac.in>, "Dr.Senthilkumar KSRCE Principal" <principal@ksrce.ac.in>, "Dr.Venkatesh Principal KSRIET" <principal@ksriet.ac.in>, K S R INSTITUTIONS <ceoksrei@gmail.com>, srinivasan rangasamy <ksrsrini@gmail.com>

Dear Team

This is further to earlier Communication regarding the training for 2020 Batch (pre final years)

Please note the below schedule and attached topics of the training programme.

Total number of student strength is 60 nos from our Institutions

As you are aware that it is an external training programme and You may nominate 1 or 2 faculty members per college for this programme.

Venue : CSE Lab 1, A Block, KSRCE

Reporting Time : 09.00 am

Schedule : 19, 20, 21, 22 & 23 Jan 2019

Timing : 09.00 am to 06.00 pm

Lab sessions may be extended after 06.00 pm based on need.

Please send the students name list to proceed further.

Regards

Dr.R.Gopalakrishnan
Central Placement Cell

3 attachments

S.No	Topic	Sub Topics	Sample Questions
1	Algorithm Analysis	<ul style="list-style-type: none"> Complexity of program Big O notation Linear search Binary search Time and space complexity Recursion Linked list Stack Queue Hash 	<ul style="list-style-type: none"> 1. Check for palindrome 2. Merge 2 linked list
2	Stack	<ul style="list-style-type: none"> Stack Queue Hash Hash 	<ul style="list-style-type: none"> 1. Check for palindrome 2. Merge 2 linked list

20190118_181924.png
70K

20190118_181956.png
216K

PRINCIPAL.
K. S. R. INSTITUTE FOR
ENGINEERING AND TECHNOLOGY
K. S. R. KALVI NAGAR,
TIRUCHENGODE-637 215,
SARAKKAL DI, TAMIL NADU.

K S R INSTITUTE FOR ENGINEERING AND TECHNOLOGY, Tiruchengode - 637215

Training and Placement Cell

Five Days Advance Data Structure Training Attendance Sheet for CSE & IT Students

BATCH : 2016 - 2020

Sem: EVEN

Academic Year: 2018 - 2019

Date of Training Programme				19.01.19		20.01.19		21.01.19		22.01.19		23.01.19	
S. No	Reg No	Name	Branch	FN	AN	FN	AN	FN	AN	FN	AN	AN	FN
1	731616104003	ANISHA.N	CSE	/	/	/	/	/	/	/	/	/	/
2	731616104031	PUGAZHIVELAN.P	CSE	/	/	/	/	/	/	/	/	/	/
3	731616104033	RAJARAJAN.A	CSE	/	/	/	/	/	/	/	/	/	/
4	731616104040	SWETHA.B	CSE	/	/	/	/	/	/	/	/	/	/
5	731616104042	VASU MITHA.R.S	CSE	/	/	/	/	/	/	/	/	/	/
6	731616104043	VELU PRABHA.S	CSE	/	/	/	/	/	/	/	/	/	/
7	731616205009	GOWRI D	IT	/	/	/	/	/	/	/	/	/	/
8	731616205011	HAKKEM M	IT	/	/	/	/	/	/	/	/	/	/
9	731616205014	JANANI M	IT	/	/	/	/	/	/	/	/	/	/
10	731616205016	JANANI T	IT	/	/	/	/	/	/	/	/	/	/
11	731616205026	OVIYA A	IT	/	/	/	/	/	/	/	/	/	/
12	731616205028	PRIYADARSHNI G	IT	/	/	/	/	/	/	/	/	/	/
13	731616205038	SUMITHA J	IT	/	/	/	/	/	/	/	/	/	/

PRINCIPAL,
K. S. R. INSTITUTE FOR
ENGINEERING AND TECHNOLOGY,
K. S. R. KALVI NAGAR,
TIRUCHENGODE-637 215,
NAMAKKAL DI, TAMIL NADU.

K S R INSTITUTE FOR ENGINEERING AND TECHNOLOGY, Tiruchengode - 637215

Training and Placement Cell



Five Days Advance Data Structure Training Attendance Sheet for CSE & IT Students

BATCH : 2016 - 2020

Sem: EVEN

Academic Year: 2018 - 2019

Fore Noon session

Date:21.01.2019

S.NO	Branch	Strength	Present	Absent	Permission
1	CSE	6	6	0	0
2	IT	7	7	0	0
Total		13	13	0	0

After Noon session

S.NO	BRANCH	Strength	Present	Absent	Leave
1	CSE	6	6	0	0
2	IT	7	7	0	0
Total		13	13	0	0

Fore Noon session

Date:22.01.2019

S.NO	Branch	Strength	Present	Absent	Permission
1	CSE	6	6	0	0
2	IT	7	7	0	0
Total		13	13	0	0

After Noon session

S.NO	BRANCH	Strength	Present	Absent	Leave
1	CSE	6	6	0	0
2	IT	7	7	0	0
Total		13	13	0	0

[Signature]
T & P OFFICER
21/1/19

[Signature]
T & P COORDINATOR

[Signature]
PRINCIPAL, PRINCIPAL
K. S. R. INSTITUTE FOR
ENGINEERING AND TECHNOLOGY,
K. S. R. KALVI NAGAR,
TIRUCHENGODE-637 215,
NAMAKKAL Dt, TAMIL NADU.
22/1/19

K S R INSTITUTE FOR ENGINEERING AND TECHNOLOGY, Tiruchengode - 637215

Training and Placement Cell



Five Days Advance Data Structure Training Attendance Sheet for CSE & IT Students

BATCH: 2016 - 2020

Sem: EVEN

Academic Year: 2018 - 2019

Fore Noon session

Date:23.01.2019

S.NO	Branch	Strength	Present	Absent	Permission
1	CSE	6	6	0	0
2	IT	7	7	0	0
Total		13	13	0	0

After Noon session

S.NO	BRANCH	Strength	Present	Absent	Leave
1	CSE	6	6	0	0
2	IT	7	7	0	0
Total		13	13	0	0

T & P OFFICER

T & P COORDINATOR

PRINCIPAL

PRINCIPAL,
K. S. R. INSTITUTE FOR
ENGINEERING AND TECHNOLOGY,
K. S. R. KALVI NAGAR,
TIRUCHENGODE 637 215,
NAMAKKAL Dt. TAMIL NADU.

K S R INSTITUTE FOR ENGINEERING AND TECHNOLOGY, Tiruchengode - 637215

Training and Placement Cell



Five Days Advance Data Structure Training Attendance Sheet for CSE & IT Students

BATCH : 2016 - 2020

Sem: EVEN

Academic Year: 2018 - 2019

Fore Noon session

Date:19.01.2019

S.NO	Branch	Strength	Present	Absent	Permission
1	CSE	6	6	0	0
2	IT	7	7	0	0
Total		13	13	0	0

After Noon session

S.NO	BRANCH	Strength	Present	Absent	Leave
1	CSE	6	6	0	0
2	IT	7	7	0	0
Total		13	13	0	0

Fore Noon session

Date:20.01.2019

S.NO	Branch	Strength	Present	Absent	Permission
1	CSE	6	6	0	0
2	IT	7	7	0	0
Total		13	13	0	0

After Noon session

S.NO	BRANCH	Strength	Present	Absent	Leave
1	CSE	6	6	0	0
2	IT	7	7	0	0
Total		13	13	0	0

[Signature]
T & P OFFICER
19/01/19

[Signature]
T & P COORDINATOR
19/01/19

[Signature]
PRINCIPAL
K. S. R. INSTITUTE FOR
ENGINEERING AND TECHNOLOGY,
K. S. R. KALVI NAGAR,
TIRUCHENGODE-637 215.
NAMAKKAL DI, TAMIL NADU.

[Signature]
PRINCIPAL
19/01/19

**K S R INSTITUTE FOR ENGINEERING AND TECHNOLOGY
TIRUCHENGODE - 637 215**

TRAINING PROGRAMME FEEDBACK FORM



Name of the Student: Amisha N Branch: CSE

Year / Sem: IV / 6

1. Name of the Training: Algorithm Analysis & stacks

2. Name of the Trainer: External Trainer

3. Students rating of Trainers: 4/5

S. No.	Date	Subject	Rating (✓)			
			Excellent	Very good	Good	Average
1	19.01.19	Algorithm Analysis		✓		

4. Two positive points about the programme:

*It was useful
Learn new thing*

5. Suggestions for improvement:

Need more content.

Date: 19.01.19

Amisha
Signature

**K S R INSTITUTE FOR ENGINEERING AND TECHNOLOGY
TIRUCHENGODE - 637 215**

TRAINING PROGRAMME FEEDBACK FORM



Name of the Student: Durgazhi Velam. P Branch: CSE

Year / Sem: IV / 6

1. Name of the Training: Algorithm Analysis & stacks

2. Name of the Trainer: External Trainer

3. Students rating of Trainers: 4/5

S. No.	Date	Subject	Rating (✓)			
			Excellent	Very good	Good	Average
1	19.01.19	Algorithm Analysis		✓		

4. Two positive points about the programme:

*It was useful
Learn new thing about*

5. Suggestions for improvement:

Need more content.

Date: 19.01.19

[Signature]
PRINCIPAL,
K. S. R. INSTITUTE FOR
ENGINEERING AND TECHNOLOGY
K. S. R. KALVI NAGAR,
TIRUCHENGODE - 637 215,
NAMAKKAL DISTRICT, TAMIL NADU.



K.S.R EDUCATIONAL INSTITUTIONS

20

TIRUCHENGODE - 637215

CIRCULAR

Sub. : Salesforce CRM Training - Students (Pre final and Final Year) - Reg.

Date : 23.10.2018

It is decided to support the students of CSE & IT (Final and Pre Final) who struggle in programming. KSREI has signed MoU with ICT Academy and Salesforce to train the students on "Declarative App Development Training - Salesforce Platform App Builder" for five days. In addition to this it is planned to conduct 5 days exclusive training on "Salesforce Certified Administrator" with the help of our certified in-house trainer Mr. Jegadeesan P. Hence, it is informed to share 50 students from Final year. (2019 batch) and 50 students from Pre Final Year.

As you are aware that we have signed MoU / CoE with Virtusa on CRM. This training will help the pre final year students to have better skills on CRM and companies like Deloitte looking for students with Salesforce CRM skills for the placements. So, this training will be useful for the current batch and next batch students.

Mr.S.P.Saravanan and Mr.P.Jegadeesan of CPC will co-ordinate the process. Tentative Training schedule is as follows

Training details	Final Years	Pre Final Years
Salesforce Certified Administrator	1 st week of December 2018	3 rd week of December 2018
Salesforce Platform App Builder	2 nd week of December 2018	

Note: It is advised to nominate minimum one faculty member in respective colleges for the above training and in future the same training can be rolled out with their support. Last date to send the name list to "ksreiplacement@gmail.com" is on 02.11.2018.

Vice - Chairman

Circulated to: The CEO, Principals of KSRCT, KSRCE, KSRIET

PRINCIPAL,
K. S. R. INSTITUTE FOR
ENGINEERING AND TECHNOLOGY,
K. S. R. KALVI NAGAR,
TIRUCHENGODE-637 215,
NAMAKKAL DI. TAMIL NADU.

TRAINING AND PLACEMENT CELL



Training Schedule [2018-2019] EVEN Semester

Ref: KSRIET/T&P/CIR/2018-2019

Date: 03.02.2019

This is to inform that all the HoD's and Training and Placement coordinators that the company specific training for IV year students(Advanced Learners) for the academic year 2018-2019 (Odd Sem) is scheduled as given below. All the eligible students should attend the Training Programme without fail. If any student skips this Training Programme he / she will not be permitted for any further Training Programme and campus recruitment process. Proper Dress Code is mandatory.

S.NO	Date	Batch	Students Strength	Resource Person
1	05.02.2019 To 09.02.2019	2015-2019	CSE(4),ECE(3) & IT(5) Total=12	ICT-ACADEMY Trainer

Session FN: 9.00 AM to 12.30 PM & Break: 10.45 AM to 11.00AM

Session AN: 01.15.PM to 04.15 PM & Lunch: 12.30 PM to 01.15 PM

[Signature]
T&P Officer
3/2/19

[Signature]
T&P Coordinator
3/2/19

[Signature]
Principal
3/2/19

- Copy to:
1. All HoDs
 2. Notice Board

[Green Signature]

PRINCIPAL.
K. S. R. INSTITUTE FOR
ENGINEERING AND TECHNOLOGY,
K. S. R. KALVI NAGA
TIRUCHENGODE - 637 215
NAMAKKAL DL, TAMIL NADU



K S R IET T&P <ksrietplacement@gmail.com>

KSREI - Salesforce App Builder Training and TNSDC's training - Reg.

2 messages

KSR EI <ksreiplacement@gmail.com>

Sun, Feb 3, 2019 at 12:37 PM

To: ksreiplacement <ksreiplacement@gmail.com>, Sankar I Placement Officer KSRCE <ksrceplacement@gmail.com>, ksrietplacement <ksrietplacement@gmail.com>, ksreitraining@gmail.com
 Cc: "Dr.Kumaravel KSRCT Principal" <principal@ksrct.ac.in>, "Dr.Senthilkumar KSRCE Principal" <principal@ksrce.ac.in>, principal <principal@ksriet.ac.in>, K S R INSTITUTIONS <ceoksrei@gmail.com>, srinivasan rangasamy <ksrsrini@gmail.com>

Dear Team

As you are aware that it is planned to conduct the training programmes for our 2019 batch students. Please note the below details is for your information and necessary action.

1. Salesforce - CRM (Support with ICT Academy)

Title

Salesforce App Builder training pgm (ICT Academy trainer)

Schedule : 05 to 09 Feb 2019 (5 Days)

Venue : CRM Lab, KSRIET

Admin & BSX (Mr.Jegadesan)

Schedule : 11 to 16 Feb 2019 (Based on availability)

Modules - Mr.Jegadesan M P

Soft copy of Modules and session plan

Practice - Students & Co-ordinators

Trialhead Login (Gmail and Salesforce Login)

Project - Students & Mr.Jegadesan & Co-ordinators

App building

Assessment - Students & Mr.Jegadesan & Co-ordinators

ICT Academy

KSREI

Objective

1. Batches (Min 75 Batches, 30,000 points)
2. Ranger (100 batches, 50,000 points)
3. International Certificate

Purpose / Selling point

Campus placements & Companies

Important Note

Co-ordinator - 1 per College (Preferably Virtusa's CRM)

Students - Status report updation (Mail to college co-ordinators & CC to ksreitraining) - 1 per day (Topics covered, Assignments / Exercises)

Requirements

Internet in the lab

Materials (Received from ICT Academy / Salesforce)

Notepad (Students)

Trainer - Accommodation / Refreshments

 PRINCIPAL.
 K. S. R. INSTITUTE FOR
 ENGINEERING AND TECHNOLOGY,
 K. S. R. KALVI NAGAR,
 TIRUCHENGODE -637 215,
 NAMAKKAL DI. TAMIL NADU.

<https://mail.google.com/mail/u/0?ik=4f78d20f09&view=pt&search=all&permthid=thread-f%3A1624430540374137836&siml=msg-f%3A1624430540374137836&siml>

TRAINING AND PLACEMENT CELL

Salesforce Declarative Development for Platform App Builder training pgm by ICT ACADEMY

Batch:2015- 2019

Academic Year: 2018- 2019

S.NO	REG NO	NAME	BRANCH	5.2.19	6.2.19	7.2.19	8.2.19	9.2.19
1	731615104012	GUNA BHARATHI T	CSE	P	P	P	P	P
2	731615104023	NISHA S	CSE	P	P	P	P	P
3	731615104036	SHALINI S	CSE	P	P	P	P	A
4	731615104044	VINOTHA V	CSE	A	P	P	P	P
5	731615106042	LOGAPRIYA.M	ECE	P	P	P	P	P
6	731615106066	SARANYA.M	ECE	P	A	P	P	P
7	731615106067	SARASWATHI P	ECE	P	P	P	P	P
8	731615205002	AISWARYA.R	IT	P	P	P	A	P
9	731615205004	AMAN KUMAR	IT	P	P	P	P	P
10	731615205011	DENMOZHI.S	IT	A	P	P	P	P
11	731615205026	MANOJKUMAR.D	IT	P	P	P	P	P
12	731615205029	PRIYANKA.S	IT	P	P	A	P	P

 PRINCIPAL,
 K. S. R. INSTITUTE FOR
 ENGINEERING AND TECHNOLOGY,
 K. S. R. KALVI NAGAR
 TIRUCHENGODE-637 215,
 NAMAKKAL DL, TAMIL NADU.

TRAINING PROGRAMME FEEDBACK FORM



Name of the Student: Ammathias Branch: IT

Year / Sem: V-7

1. Name of the Training: Salesforce

2. Name of the Trainer: External

3. Students rating of Trainers: 4/5

S. No.	Date	Subject	Rating (✓)			
			Excellent	Very good	Good	Average
1	23/10/18	Java		✓		

4. Two positive points about the programme:

It was useful

5. Suggestions for improvement:

Need more content

Date: 23/10/18

Ammathias
Signature

TRAINING PROGRAMME FEEDBACK FORM



Name of the Student: Prinyanka S Branch: IT

Year / Sem: V-7

1. Name of the Training: Salesforce

2. Name of the Trainer: External

3. Students rating of Trainers: 4/5

S. No.	Date	Subject	Rating (✓)			
			Excellent	Very good	Good	Average
1	23/10/18	Java		✓		

PRINCIPAL,
K. S. R. INSTITUTE FOR
ENGINEERING AND TECHNOLOGY,
K. S. R. KALVIYOGAR,
TIRUCHENGODE-637 215,
NAMAKKAL DI, TAMIL NADU.

4. Two positive points about the programme:

It was useful

5. Suggestions for improvement:

Need more content

Date: 23/10/18

Prinyanka
Signature

**K S R INSTITUTE FOR ENGINEERING AND TECHNOLOGY
TIRUCHENGODE – 637 215**

TRAINING PROGRAMME FEEDBACK FORM



Name of the Student: Nishas Branch: CSE

Year / Sem: V - 1

1. Name of the Training: Salesforce

2. Name of the Trainer: External

3. Students rating of Trainers: 4/5

S. No.	Date	Subject	Rating (✓)			
			Excellent	Very good	Good	Average
1	23/10/18	Java		✓		

4. Two positive points about the programme:

It was useful

5. Suggestions for improvement:

need more content

Date: 23/10/18

[Signature]
Signature

**K S R INSTITUTE FOR ENGINEERING AND TECHNOLOGY
TIRUCHENGODE – 637 215**

TRAINING PROGRAMME FEEDBACK FORM



Name of the Student: Shalini N Branch: CSE

Year / Sem: V - 1

1. Name of the Training: Salesforce

2. Name of the Trainer: External

3. Students rating of Trainers: 4/5

S. No.	Date	Subject	Rating (✓)			
			Excellent	Very good	Good	Average
1	23/10/18	Java		✓		

PRINCIPAL,
K. S. R. INSTITUTE FOR
ENGINEERING AND TECHNOLOGY,
K. S. R. KALVINAGAR
TIRUCHENGODE - 637 215,
NAMAKKAL Dt, TAMIL NADU.

4. Two positive points about the programme:

It was useful

5. Suggestions for improvement:

need more content

Date: 23/10/18

[Signature]
Signature

TRAINING AND PLACEMENT CELL



Training Schedule [2018-2019] EVEN Semester

Ref: KSRIET/T&P/CIR/2018-2019

Date: 03.02.2019

This is to inform that all the HoD's and Training and Placement coordinators that the company specific training for IV year students(Advanced Learners) for the academic year 2018-2019 (Odd Sem) is scheduled as given below. All the eligible students should attend the Training Programme without fail. If any student skips this Training Programme he / she will not be permitted for any further Training Programme and campus recruitment process. Proper Dress Code is mandatory.

S.NO	Date	Batch	Students Strength	Resource Person
1	06.02.2019(onwards) 23 days	2015-2019	ECE-6 Total=06	ICT-ACADEMY Trainer & Mr.P.Jagadeesan

Session FN: 9.00 AM to 12.30 PM & Break: 10.45 AM to 11.00AM

Session AN: 01.15.PM to 04.15 PM & Lunch: 12.30 PM to 01.15 PM

T&P Officer

T&P Coordinator

Principal

- Copy to:
1. All HoDs
 2. Notice Board

PRINCIPAL,
K. S. R. INSTITUTE FOR
ENGINEERING AND TE
K. S. R. KAIVIA
TIRUCHENGODE

Banner - CPC
Whiteboard and Projector - IET

2. TNSDC (Support with ICT Academy)

Title

Big Data and Analytics / Cloud Computing / Salesforce CRM

Schedule

06 Feb 2019 onwards (23 days)

Venue

DELLEMC Lab, KSRCE

Modules - Mr.Jegadesan M P

Soft copy of Modules and session plan

Practice - Students & Co-ordinators

Trialhead Login (Gmail and Salesforce Login) + Big Data and Data Analytics + Cloud Computing

Project - Students & Mr.Jegadesan & Faculty co-ordinator

App building + Cloud platform + Data Analysis

Assessment - Students & Mr.Jegadesan & Faculty co-ordinator

ICT Academy

KSREI

Objective

1. Batches (Min 75 Batches, 30,000 points)
2. Ranger (100 batches, 50,000 points)
3. International Certificate

Purpose / Selling point

Campus placements & Companies

Important Note

Co-ordinator - 1 per College (Preferably faculty who attended the Big Data)

Students - Status report updation (Mail to college co-ordinators & CC to ksreitraining) - 1 per day (Topics covered, Assignments / Exercises)

Requirements

Internet in the lab

Materials

Notepad (Students)

Trainer - Accommodation / Refreshments

Banner - CPC

Whiteboard and Projector - CE

Thanks & Regards

Dr.R.GOPALAKRISHNAN

HEAD - PLACEMENTS

PRINCIPAL,
K. S. R. INSTITUTE FOR
ENGINEERING AND TECHNOLOGY,
K. S. R. KALVINAGAR,
TIRUCHENGODE 637 215,
NAMAKKAL DT, TAMIL NADU.



KSR
SINCE 1954

K.S.R. Educational Institutions

Contact Number : 95430 55555 | 99941 50505

Tiruchengode - 637215 | Namakkal (DT) | Tamil Nadu

KSRIET TRAINING AND PLACEMENT <ksrietplacement@gmail.com>





Mon, Feb 4, 2019 at 7:45 PM

To: Dept Mails <ksrietitplacement@gmail.com>, Dept Mails <ksrietcseplacement@gmail.com>, Dept Mails <ksrieteplacement@gmail.com>

[Quoted text hidden]



**PRINCIPAL,
K. S. R. INSTITUTE FOR
ENGINEERING AND TECHNOLOGY,
K. S. R. KALVI NAGAR,
TIRUCHENGODE-637 215,
NAMAKKAL DL TAMIL NADU.**

S.No	1.Name of the Trainee 2.Father's Name 3.Address	Admission Registration No.	DOB	Sex	Qualificati on With Stream	Religion	Commun ity	Ration Card/ Adhar No	Mobile No	Photo	Remarks
3	DHIVYA.M MUTHUSAMY. S 4/369,vaikuntham,aghrahara m,salem-637103	731615106015	18.02.1998	FEMALE	BE - ECE	Hindu	BCM	384132115796	9865130484		Nil
4	KARTHIKA.D Duraimurugan.T 2/70,Parsuraman street, Harur(Tk),Dharmapuri(Dt)- 636903	731615106032	27.07.1998	FEMALE	BE - ECE	Hindu	BC	3339 9333 2269	8428647729		Nil
5	KEERTHANA.L LOGANATHAN.D KUNGUMAK KALIAMMAN KOVIL STREET, VEDASANDUR(tk)-624710, DINDICUL(dt)	731615106037	13.05.1998	FEMALE	BE - ECE	Hindu	MBC	497590541286	9994896297		Nil
6	PRAVEEN KUMAR V VELMURUGAN S 208,MELKOTTAI,SANYASIPAT TI PO,SANYASIPATTI,BHAVANI TK,ERODE DT-638311	731615106057	06.03.1998	MALE	BE - ECE	Hindu	MBC	994000183484	9952286105		Nil

PRINCIPAL.
K. S. R. INSTITUTE FOR
ENGINEERING AND TECHNOLOGY,
K. S. R. KALVI NAGAR,
TIRUCHENGODE-637 215,
NAMAKKAL Dt, TAMIL NADU.



TNSDC - Employability Skill Training

Annexure - I

Tamil Nadu Skill Development Corporation

Trainees Enrolment Details

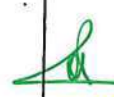
Name of the Training provider	ICT Academy of Tamil Nadu
Course Name	Certificate Program in " IT Infrastructure & Services "
Total No.of Trainees(Target)	50
Batch No	1
Training Commenced on	
Probable Date of Completion	06 Feb 2019 onwards (23 days)
G.O.No. & Date in which Training Sactioned	G.O.(MS)No.204

S.No	1.Name of the Trainee 2.Father's Name 3.Address	Admission Registration No.	DOB	Sex	Qualificati on With Stream	Religion	Commun ity	Ration Card/ Adhar No	Mobile No	Photo	Remarks
1	DEVI.U UTHIRABALAN. R 81/68,NADAR ST, MALLAMOOPAMPATTY, AYEMPERUMALPATTY(P.O),S ALEM-636 302.	731615106012	05.10.1997	FEMALE	BE - ECE	Hindu	BC	8081 4329 0138	9597219874		Nil
2	DHARANI.R RAJAN. A 37 A.K E ROAD NO 1 TIRUCHENGODE NAMAKKAL	731615106013	21.01.1998	FEMALE	BE - ECE	Hindu	SC	 NO	8248981572		Nil

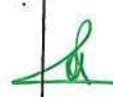
PRINCIPAL,
K. S. R. INSTITUTE FOR
ENGINEERING AND TECHNOLOGY
K. S. R. KALVI NAGAR,
TIRUCHENGODE-637 219



K S R INSTITUTE FOR ENGINEERING AND TECHNOLOGY
Tiruchengode, Namakkal – 637215
(Accredited by NBA, Affiliated to Anna University, Chennai)

Department of Mechanical Engineering

Value Added Course – Syllabus

The course covers the topics you need to review for the **AutoCAD** including:

Module 1: INTRODUCTION TO AUTOCAD

6

AutoCAD Screen Components- Drawing Area Command -Window Navigation bar Status bar
AUTOCAD Introduction-Software Requirements- Files handling in CAD- Draw toolbar- Modify
toolbar- Dimensioning toolbar- Opening an Existing Drawing- Quitting AutoCAD

Module 2: Introduction to OF Tool bars

7

Functional keys and properties - Layers and leaders- Tool menu customization- Geometric
constraints- Dimension constraints- Drawing Lines in AutoCAD- Invoking tools Using Dynamic
INPUT/Command- Prompt Coordinate Systems

Module 3: Starting With Advanced Sketching

8

Drawing Arcs- Drawing Rectangles -Drawing Ellipses- Drawing Regular Polygon- Drawing
Polylines Placing Points -Drawing Infinite Lines Writing a Single Line Text- Working with Layers-
Object Properties- Drafting Settings dialog box

Module 4: Editing Sketched Objects

9

Editing Sketches- Moving the Sketched Objects -Copying the Sketched Objects- Creating Multiple
Copies Creating a Single Copy Offsetting Sketched Objects- Rotating Sketched Objects Scaling the
Sketched Objects -Filletting the Sketches- Chamfering the Sketches- Trimming the Sketched Objects
Extending the Sketched Objects- Stretching the Sketched Objects -Lengthening the Sketched
Objects -objects Text Mirroring

Module 5: Isometric Drawings

8

Isometric drawings- Extrusion-View, visual styles and orbit- Solid (3D) modelling- Solid editing
operations- Rendering and scenes

Total: 38 Hours

COORDINATOR

Dr. M. VENKATESAN, M.E., Ph.D.,
PRINCIPAL,
K S R INSTITUTE FOR
ENGINEERING AND TECHNOLOGY,
K.S.R. KALVI NAGAR,
TIRUCHENGODE-637 215,
NAMAKKAL DI, TAMIL NADU.



K S R INSTITUTE FOR ENGINEERING AND TECHNOLOGY
Tiruchengode, Namakkal – 637215
(Accredited by NBA, Affiliated to Anna University, Chennai)

Department of Mechanical Engineering

Value Added Course - AutoCAD

Schedule

Date: 18//06/2018

S.No.	Date	Topic	Name of the Faculty
1.	02/07/18	AutoCAD Screen Components- Drawing Area Command Window Navigation bar Status bar AUTOCAD Introduction	Mr.S.Mohanavelan & Mr.M.Sambath Kumar
2.	03/07/18	Software Requirements- Files handling in CAD- Draw toolbar	Mr.A.Premkumar & Mr.K.Gopalakrishnan
3.	04/07/18	Modify toolbar- Dimensioning toolbar	Mr.S.Mohanavelan & Mr.M.Sambath Kumar
4.	05/07/18	Opening an Existing Drawing- Quitting AutoCAD	Mr.A.Premkumar & Mr.K.Gopalakrishnan
5.	06/07/18	Functional keys and properties - Layers and leaders- Tool menu customization	Mr.S.Mohanavelan & Mr.M.Sambath Kumar
6.	07/07/18	Geometric constraints- Dimension constraints	Mr.A.Premkumar & Mr.K.Gopalakrishnan
7.	09/07/18	Drawing Lines in AutoCAD	Mr.S.Mohanavelan & Mr.M.Sambath Kumar
8.	10/07/18	Invoking tools Using Dynamic INPUT/Command- Prompt Coordinate Systems	Mr.A.Premkumar & Mr.K.Gopalakrishnan
9.	11/07/18	Drawing Arcs- Drawing Rectangles -Drawing Ellipses	Mr.S.Mohanavelan & Mr.M.Sambath Kumar
10.	12/07/18	Drawing Regular Polygon- Drawing Polylines Placing Points	Mr.A.Premkumar & Mr.K.Gopalakrishnan
11.	13/07/18	Drawing Infinite Lines Writing a Single Line Text	Mr.S.Mohanavelan & Mr.M.Sambath Kumar
12.	23/07/18	Working with Layers- Object Properties- Drafting Settings dialog box	Mr.A.Premkumar & Mr.K.Gopalakrishnan
13.	24/07/18	Editing Sketches- Moving the Sketched Objects - Copying the Sketched Objects	Mr.S.Mohanavelan & Mr.M.Sambath Kumar
14.	25/07/18	Creating Multiple Copies Creating a Single Copy Offsetting Sketched Objects- Rotating Sketched Objects Scaling the Sketched Objects	Mr.A.Premkumar & Mr.K.Gopalakrishnan
15.	26/07/18	Filleting the Sketches- Chamfering the Sketches- Trimming the Sketched Objects Extending the Sketched Objects	Mr.S.Mohanavelan & Mr.M.Sambath Kumar
16.	27/07/18	Stretching the Sketched Objects -Lengthening the Sketched Objects -objects Text Mirroring	Mr.A.Premkumar & Mr.K.Gopalakrishnan

Dr. M. VENKATESAN, M.E., Ph.D.,
 PRINCIPAL,
 K S R INSTITUTE FOR
 ENGINEERING AND TECHNOLOGY,
 K.S.R. KADAVU NAGAR,
 TIRUCHENGODE-637 215,

17.	28/07/18	Isometric drawings- Extrusion	Mr.S.Mohanavelan & Mr.M.Sambath Kumar
18.	30/07/18	View, visual styles and orbit	Mr.A.Premkumar & Mr.K.Gopalakrishnan
19.	31/07/18	Solid (3D) modelling	Mr.S.Mohanavelan & Mr.M.Sambath Kumar
20.	01/08/18	Solid editing operations- Rendering and scenes	Mr.A.Premkumar & Mr.K.Gopalakrishnan

Faculty Incharge

HOD

Dr. M. VENKATESAN, M.E., Ph.D.,
 PRINCIPAL,
 K S R INSTITUTE FOR
 ENGINEERING AND TECHNOLOGY,
 K.S.R. BALVI NAGAR,
 TIRUCHENGODUR-637 215,
 NAMAKKAL DL, TAMIL NADU.

K S R Institute for Engineering and Technology
Department of Mechanical Engineering
Value Added Course on AUTO CAD

Year:II

Attendance

Academic Year:2018-19

S.NO	REG.NO	NAME OF THE STUDENT	02.07. 18	03.07. 18	04.07. 18	05.07. 18	06.07. 18	07.07. 18	09.07. 18	10.07. 18	11.07. 18	12.07. 18	13.07. 18	23.07. 18	24.07. 18	25.07. 18	26.07. 18	27.07. 18	28.07. 18	30.07. 18	31.07. 18	01.08. 18	
1	731617114001	AADHI VISHWANATH M	/	/	/	/	/	/	/	/	/	/	/	/	/	/	/	/	/	/	/	/	/
2	731617114002	AJITH R	/	/	/	/	/	/	/	/	/	/	/	/	/	/	/	/	/	/	/	/	/
3	731617114004	ARUNESH J	/	/	/	/	/	/	/	/	/	/	/	/	/	/	/	/	/	/	/	/	/
4	731617114005	ARUN KUMAR S	/	/	/	/	/	/	/	/	/	/	/	/	/	/	/	/	/	/	/	/	/
5	731617114006	ARUN KUMAR T	/	/	/	/	/	/	/	/	/	/	/	/	/	/	/	/	/	/	/	/	/
6	731617114007	ARUN PRABAKARAN J	/	/	/	/	/	/	/	/	/	/	/	/	/	/	/	/	/	/	/	/	/
7	731617114008	ASWANTH KUMAR K	/	/	/	/	/	/	/	/	/	/	/	/	/	/	/	/	/	/	/	/	/
8	731617114009	ASWIN M	/	/	/	/	/	/	/	/	/	/	/	/	/	/	/	/	/	/	/	/	/
9	731617114010	BALAJI S	/	/	/	/	/	/	/	/	/	/	/	/	/	/	/	/	/	/	/	/	/
10	731617114011	BHAGAVATHI PERUMAL G	/	/	/	/	/	/	/	/	/	/	/	/	/	/	/	/	/	/	/	/	/
11	731617114012	BHARANIDHARAN R	/	/	/	/	/	/	/	/	/	/	/	/	/	/	/	/	/	/	/	/	/
12	731617114013	BOOPATHI S	/	/	/	/	/	/	/	/	/	/	/	/	/	/	/	/	/	/	/	/	/
13	731617114014	BOOPATHIRAJA M	/	/	/	/	/	/	/	/	/	/	/	/	/	/	/	/	/	/	/	/	/
14	731617114015	BUVANESVARAN S	/	/	/	/	/	/	/	/	/	/	/	/	/	/	/	/	/	/	/	/	/
15	731617114016	CHANDRU K	/	/	/	/	/	/	/	/	/	/	/	/	/	/	/	/	/	/	/	/	/
16	731617114018	CHANDRU S	/	/	/	/	/	/	/	/	/	/	/	/	/	/	/	/	/	/	/	/	/
17	731617114019	DEEPAK K	/	/	/	/	/	/	/	/	/	/	/	/	/	/	/	/	/	/	/	/	/
18	731617114020	DHARANKUMAR S	/	/	/	/	/	/	/	/	/	/	/	/	/	/	/	/	/	/	/	/	/
19	731617114021	DHARSHAN C M	/	/	/	/	/	/	/	/	/	/	/	/	/	/	/	/	/	/	/	/	/
20	731617114022	DINESHKUMAR D	/	/	/	/	/	/	/	/	/	/	/	/	/	/	/	/	/	/	/	/	/
21	731617114023	DINESHKUMAR R	/	/	/	/	/	/	/	/	/	/	/	/	/	/	/	/	/	/	/	/	/
22	731617114026	GOBIRAJ R	/	/	/	/	/	/	/	/	/	/	/	/	/	/	/	/	/	/	/	/	/
23	731617114027	GOKULNATH K	/	/	/	/	/	/	/	/	/	/	/	/	/	/	/	/	/	/	/	/	/
24	731617114028	GOKULPRASANTH M	/	/	/	/	/	/	/	/	/	/	/	/	/	/	/	/	/	/	/	/	/
25	731617114029	GOKULRAJ B	/	/	/	/	/	/	/	/	/	/	/	/	/	/	/	/	/	/	/	/	/
26	731617114030	GOVINDHARASU R	/	/	/	/	/	/	/	/	/	/	/	/	/	/	/	/	/	/	/	/	/
27	731617114031	GOWTHAM KUMAR T	/	/	/	/	/	/	/	/	/	/	/	/	/	/	/	/	/	/	/	/	/
28	731617114033	HARIHARAN G	/	/	/	/	/	/	/	/	/	/	/	/	/	/	/	/	/	/	/	/	/
29	731617114035	HARIPRASATH P	/	/	/	/	/	/	/	/	/	/	/	/	/	/	/	/	/	/	/	/	/
30	731617114036	HARIRAM B	/	/	/	/	/	/	/	/	/	/	/	/	/	/	/	/	/	/	/	/	/
31	731617114037	INDIRAJITH M	/	/	/	/	/	/	/	/	/	/	/	/	/	/	/	/	/	/	/	/	/
32	731617114038	JAGATHESHWARAN N	/	/	/	/	/	/	/	/	/	/	/	/	/	/	/	/	/	/	/	/	/
33	731617114039	KMALESH T	/	/	/	/	/	/	/	/	/	/	/	/	/	/	/	/	/	/	/	/	/
34	731617114040	KARTHICK R	/	/	/	/	/	/	/	/	/	/	/	/	/	/	/	/	/	/	/	/	/

D. M. VENKATESAN M.E., PH.D.,
 PRINCIPAL
 K S R INSTITUTE FOR
 ENGINEERING AND TECHNOLOGY,
 K.S.R. BALYI NAGAR,
 TIRUCHENBODE-637 215,
 NAMAKKAL DISTRICT, TAMIL NADU.

S.NO	REG.NO	NAME OF THE STUDENT	02.07. 18	03.07. 18	04.07. 18	05.07. 18	06.07. 18	07.07. 18	09.07. 18	10.07. 18	11.07. 18	12.07. 18	13.07. 18	23.07. 18	24.07. 18	25.07. 18	26.07. 18	27.07. 18	28.07. 18	30.07. 18	31.07. 18	01.08. 18
35	731617114041	KARTHIK A S	/	/	/	/	/	/	/	/	/	/	/	/	/	/	/	/	/	/	/	/
36	731617114042	KARTHIKEYAN S	/	/	/	/	/	/	/	/	/	/	/	/	/	/	/	/	/	/	/	/
37	731617114043	KARTHIKEYAN T	/	/	/	/	/	/	/	/	/	A	/	/	/	/	/	/	/	/	/	/
38	731617114044	KARUPPALAH K	/	/	/	/	/	/	/	/	/	/	/	/	/	/	/	/	/	/	/	/
39	731617114045	KATHIRVEL M	/	/	/	/	/	/	/	/	/	/	/	/	/	/	/	/	/	/	/	/
40	731617114046	KAVIN M	A	/	/	/	/	/	/	/	/	/	/	A	/	/	/	/	/	/	/	/
41	731617114048	KAVINKUMAR C	/	/	/	/	/	/	/	/	/	/	/	/	/	/	/	/	/	/	/	/
42	731617114049	KAVIRAJ M	/	/	/	/	/	/	/	/	/	/	/	/	/	/	/	/	/	/	/	/
43	731617114050	KIRUBAKARAN K	/	/	/	/	/	/	/	/	A	/	/	/	/	/	/	/	/	/	/	/
44	731617114051	KIRUBAKARAN K	/	/	A	/	/	/	/	/	/	/	/	/	/	/	/	/	/	/	/	/
45	731617114052	LOGESH M	/	/	/	/	/	/	/	/	/	/	/	/	/	/	/	/	/	/	/	/
46	731617114053	MADESH K	/	/	/	/	/	/	/	/	/	/	/	/	/	/	/	/	/	/	/	/
47	731617114054	MANIKANDAN R	/	/	/	/	/	/	/	/	/	/	/	/	/	/	/	/	/	/	/	/
48	731617114055	MANOJ N	/	/	/	/	/	A	/	/	/	/	/	/	/	/	A	/	/	/	/	/
49	731617114056	MEIYANANDHAN V	/	/	/	/	/	/	/	/	/	/	/	/	/	/	/	/	/	/	/	/
50	731617114057	MOHAMED ABBAS M	/	/	/	/	/	/	/	/	/	/	/	/	/	/	/	/	/	/	/	/
51	731617114058	MOHANARAJ C	/	/	/	/	/	/	/	/	/	/	/	/	/	/	/	/	/	/	A	/
52	731617114059	MONISH KANNA M	/	/	/	/	/	/	/	/	/	/	/	/	/	/	/	/	/	/	/	/
53	731617114060	MUNEESWARAN D	/	/	/	/	/	/	/	/	/	/	/	/	/	/	/	/	/	/	/	/
54	731617114061	NANDHAKUMAR G	/	/	/	/	/	/	/	/	/	/	/	/	/	/	/	/	/	/	/	/
55	731617114062	NARESH M	/	/	/	/	/	/	/	/	/	/	/	/	/	/	/	/	/	/	/	/
56	731617114063	NAVEEN M	/	/	/	/	/	/	/	/	/	A	/	/	/	/	/	/	/	/	/	/
57	731617114064	NAVEEN V	/	/	/	/	/	/	/	/	/	/	/	/	/	/	/	/	/	/	/	/
58	731617114065	NIKHIL S	/	/	/	/	/	/	/	/	/	/	/	/	/	/	/	/	/	/	/	/
59	731617114067	PAVITHRAN G	/	/	/	/	/	A	/	/	/	/	/	A	/	/	/	/	/	A	/	/
60	731617114069	PRADEEP N	/	/	/	/	/	/	/	/	/	/	/	/	/	/	/	/	/	/	/	/
61	731617114070	PRADHAP R	/	/	/	/	/	/	/	/	/	/	/	/	/	/	/	/	/	/	/	/
62	731617114071	PRAGATHEESWAR E	/	/	/	/	/	/	/	/	/	/	/	/	A	/	/	/	/	/	/	/
63	731617114072	PRASATH R	/	/	/	/	/	/	/	/	/	/	/	/	/	/	/	/	/	/	/	/
64	731617114073	PRATHIYUMANAN M	/	/	/	/	/	/	/	/	/	/	/	/	/	/	/	/	/	/	/	/
65	731617114074	PRAVEEN H	/	/	/	/	/	/	/	/	/	/	/	/	/	/	/	/	/	/	/	/
66	731617114075	PRAVEENKUMAR V	/	/	/	/	A	/	/	/	/	/	/	/	/	/	/	/	/	/	/	/
67	731617114076	PRAVEEN KUMAR S	/	/	/	/	/	/	/	/	/	/	/	/	/	/	/	/	/	/	/	/
68	731617114077	PREMRAJ S	/	/	/	/	/	/	/	/	/	/	/	/	/	/	/	/	/	/	/	/

 Dr. M. VENKATESAN, M.E., Ph.D.
 PRINCIPAL,
 K S R INSTITUTE FOR
 ENGINEERING AND TECHNOLOGY,
 K.S.R. KALYANAGAR,
 TIRUCHENGODE-637 215,
 NAMAKKAL Dt, TAMIL NADU.

S.NO	REG.NO	NAME OF THE STUDENT	02.07.	03.07.	04.07.	05.07.	06.07.	07.07.	09.07.	10.07.	11.07.	12.07.	13.07.	23.07.	24.07.	25.07.	26.07.	27.07.	28.07.	30.07.	31.07.	01.08.	
			18	18	18	18	18	18	18	18	18	18	18	18	18	18	18	18	18	18	18	18	18
69	731617114078	RAHUL V	/	/	/	/	/	/	/	/	/	/	/	/	/	/	/	/	/	/	/	/	/
70	731617114079	RAMKUMAR B	/	/	/	/	/	/	/	/	/	/	/	/	/	/	/	/	/	/	/	/	/
71	731617114080	RANJITHKUMAR K	/	/	/	/	/	/	/	/	/	/	/	/	/	/	/	/	/	/	/	/	/
72	731617114081	SABARINATHAN S	/	/	/	/	/	/	/	/	/	/	/	/	/	/	/	/	/	/	/	/	/
73	731617114082	SAKTHIVEL P	/	/	/	/	/	/	/	/	/	/	/	/	/	/	/	/	/	/	/	/	/
74	731617114083	SANTHOSHKUMAR G	A	/	/	/	/	/	/	/	/	/	/	/	/	/	/	/	/	/	/	/	/
75	731617114085	SARATH KUMAR M	/	/	/	/	/	/	/	/	/	/	/	/	/	/	/	/	/	/	/	/	/
76	731617114086	SARAVANAA M	/	/	/	/	/	/	/	/	A	/	/	/	/	/	/	/	/	/	/	/	/
77	731617114087	SARAVANAN R	/	/	/	A	/	/	/	/	/	/	/	A	/	/	/	/	/	/	/	/	/
78	731617114088	SASIKARAN S	/	/	/	/	/	/	/	/	/	/	/	/	/	/	/	/	/	/	/	/	/
79	731617114089	SATHISHKUMAR S	/	/	/	/	/	/	/	/	/	/	/	/	/	/	/	/	/	/	/	/	/
80	731617114091	SRIDHAR C	/	/	/	/	/	/	/	/	/	/	/	/	/	/	/	/	/	/	/	/	/
81	731617114092	SRIDHARAN R	/	/	/	/	/	/	/	/	/	/	/	/	/	/	/	/	/	/	A	/	/
82	731617114093	SURENDHAR P	/	/	/	/	/	/	/	A	/	/	/	/	/	/	/	/	/	/	/	/	/
83	731617114094	SURESHKUMAR A	/	/	/	/	/	/	/	/	/	/	/	/	/	/	/	/	/	/	/	/	/
84	731617114095	SURESHMOORTHY P	/	/	A	/	/	/	/	/	/	/	/	/	A	/	/	/	/	/	/	/	/
85	731617114096	SURYAMOORTHY R	/	/	/	/	/	/	/	/	/	/	/	/	/	/	/	/	/	/	/	/	/
86	731617114098	TAMILSELVAN V	/	/	/	/	/	/	/	/	/	/	/	/	/	/	/	/	/	/	/	/	/
87	731617114099	THAMIL SELVAM B	/	/	/	/	/	/	/	/	/	/	/	/	/	/	/	/	/	/	/	/	/
88	731617114100	THIRUPATHI M	/	/	/	/	/	/	/	/	/	/	/	/	/	/	/	/	/	A	/	/	/
89	731617114101	THULASI RAMAN R	/	/	/	/	/	/	/	/	/	/	/	/	/	/	/	/	/	/	/	/	/
90	731617114102	VIGNESH R	/	/	/	/	/	/	/	/	/	/	/	/	/	A	/	/	/	/	/	/	/
91	731617114103	VIGNESHWARAN S	/	/	/	/	/	/	/	/	/	/	/	/	/	/	/	/	/	/	/	/	/
92	731617114104	VIJAYAKUMAR C	/	/	/	/	/	/	/	/	/	/	A	/	/	/	/	/	/	/	/	/	/
93	731617114105	VINITH D	/	/	/	/	/	/	/	/	/	/	/	/	/	/	/	/	/	/	/	/	/
94	731617114106	VINOTH KUMAR T	/	A	/	/	/	/	/	/	/	/	/	/	/	/	/	/	/	/	/	/	/
95	731617114107	YASWANTHKARTHIK S	/	/	/	/	/	/	/	/	/	/	/	/	/	/	/	/	/	/	/	/	/
96	731617114108	YOGESH N	/	/	/	/	/	/	/	/	/	/	/	/	/	/	/	/	/	/	/	/	/
97	731617114302	DHINESHWARAN G	/	/	/	/	/	/	/	/	/	/	/	/	/	/	/	/	/	/	/	/	/
98	731617114303	HARIPRASATH M	/	/	/	/	A	/	/	/	A	/	/	/	/	/	/	/	/	/	/	/	A
99	731617114304	KANNAN E	/	/	/	/	/	/	/	/	/	/	/	/	/	/	/	/	/	/	/	/	/
100	731617114305	MANIKANDAN V	/	/	/	/	/	/	/	/	/	/	/	/	/	/	/	/	/	/	/	/	/
101	731617114306	NANTHAKUMAR P	/	/	/	/	/	/	/	/	/	/	/	/	/	/	/	/	/	/	A	/	/
Course Coordinator			/	/	/	/	/	/	/	/	/	/	/	/	/	/	/	/	/	/	/	/	/
HoD			/	/	/	/	/	/	/	/	/	/	/	/	/	/	/	/	/	/	/	/	/

Dr. M. VENKATESAN, M.E., Ph.D.,
PRINCIPAL,
K S R INSTITUTE FOR
ENGINEERING AND TECHNOLOGY,
K.S.R. KALVI NAGAR,
TIRUCHENGODE-637 215,
NAMAKKAL DI, TAMIL NADU.

KSR INSTITUTE FOR ENGINEERING AND TECHNOLOGY
DEPARTMENT OF MECHANICAL ENGINEERING

Centre for Value Added Education (CENVAE)

Assessment Test for AUTOCAD course

Attend any one question

Date: 1-8-18

MARK (50)

1. Draw the following 2D diagram in AUTOCAD software

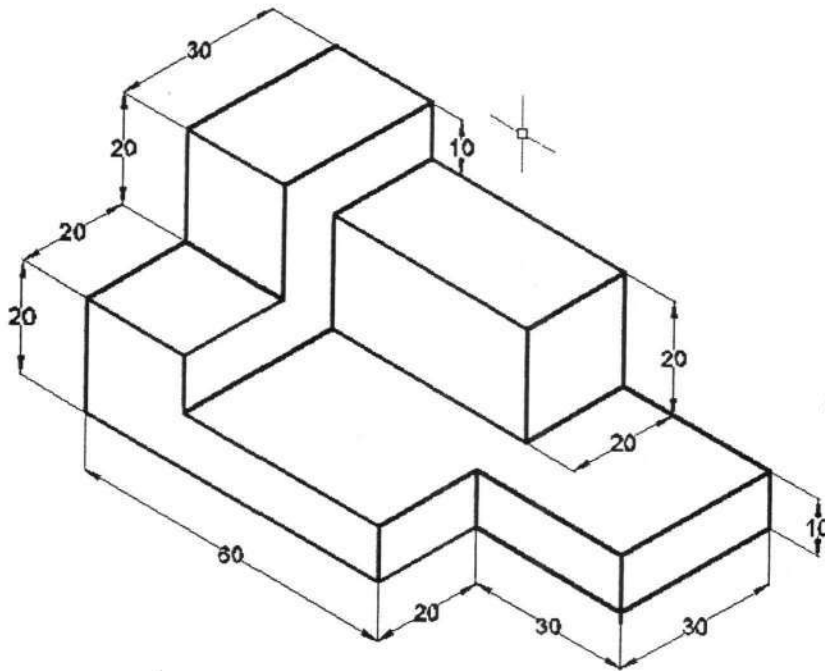

2. Draw the following 2D diagram in AUTOCAD software

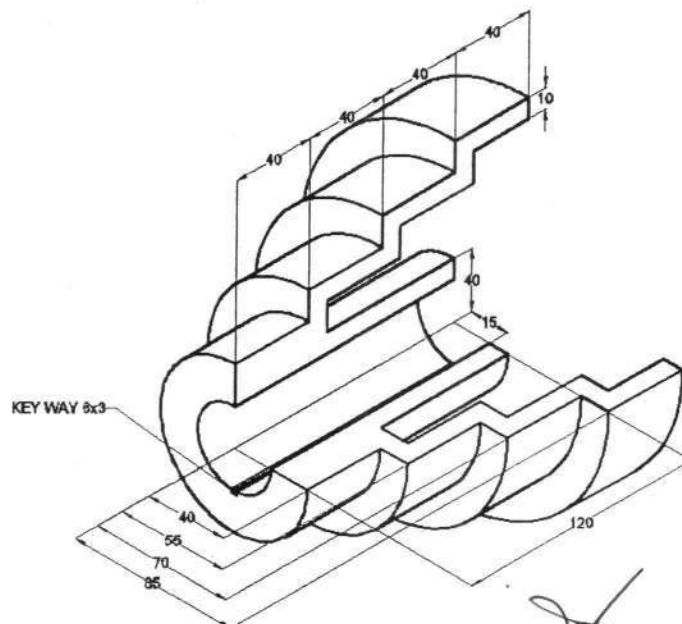

COORDINATOR



Dr. M. VENKATESAN, M.E., Ph.D.,
PRINCIPAL, HOD

K S R INSTITUTE FOR
ENGINEERING AND TECHNOLOGY,
K.S.R. KALVI NAGAR,
TIRUCHENGODE-637 215,
TAMIL NADU

K S R Institute for Engineering and Technology
Department of Mechanical Engineering
Value Added Course on AUTO CAD

Year:II Assessment Mark Acadimic Year:2018-19

S.NO	REG.NO	NAME OF THE STUDENT	Marks(50)
1	731617114001	AADHI VISHWANATH M	45
2	731617114002	AJITH R	35
3	731617114004	ARUNESH J	39
4	731617114005	ARUN KUMAR S	40
5	731617114006	ARUN KUMAR T	45
6	731617114007	ARUN PRABAKARAN J	42
7	731617114008	ASWANTH KUMAR K	45
8	731617114009	ASWIN M	40
9	731617114010	BALAJI S	42
10	731617114011	BHAGAVATHI PERUMAL G	43
11	731617114012	BHARANIDHARAN R	45
12	731617114013	BOOPATHI S	42
13	731617114014	BOOPATHIRAJA M	39
14	731617114015	BUVANESVARAN S	45
15	731617114016	CHANDRU K	40
16	731617114018	CHANDRU S	39
17	731617114019	DEEPAK K	38
18	731617114020	DHARANKUMAR S	40
19	731617114021	DHARSHAN C M	35
20	731617114022	DINESHKUMAR D	36
21	731617114023	DINESHKUMAR R	35
22	731617114026	GOBIRAJ R	46
23	731617114027	GOKULNATH K	45
24	731617114028	GOKULPRASANTH M	40
25	731617114029	GOKULRAJ B	39
26	731617114030	GOVINDHARASU R	37
27	731617114031	GOWTHAM KUMAR T	38
28	731617114033	HARIHARAN G	35
29	731617114035	HARIPRASATH P	36
30	731617114036	HARIRAM B	40
31	731617114037	INDIRAJITH M	42
32	731617114038	JAGATHESHWARAN N	40
33	731617114039	KAMALESH T	43
34	731617114040	KARTHICK R	45
35	731617114041	KARTHIK A S	36
36	731617114042	KARTHIKEYAN S	35
37	731617114043	KARTHIKEYAN T	36
38	731617114044	KARUPPAIAH K	35
39	731617114045	KATHIRVEL M	38
40	731617114046	KAVIN M	37
41	731617114048	KAVINKUMAR C	39
42	731617114049	KAVIRAJ M	45
43	731617114050	KIRUBAKARAN K	35
44	731617114051	KIRUBAKARAN K	39
45	731617114052	LOGESH M	40
46	731617114053	MADESH K	45
47	731617114054	MANIKANDAN R	42
48	731617114055	MANOJ N	45

Dr..M. VENKATESAN, M.E., Ph.D
 PRINCIPAL,
 K S R INSTITUTE FOR
 ENGINEERING AND TECHNOLOGY,
 K. S. R. PALVI NAGAR,
 THROUGH NO. 637 215,
 CHENNAI 600011

S.NO	REG.NO	NAME OF THE STUDENT	Marks(50)
49	731617114056	MEIYANANDHAN V	40
50	731617114057	MOHAMED ABBAS M	40
51	731617114058	MOHANARAJ C	45
52	731617114059	MONISH KANNA M	35
53	731617114060	MUNEESWARAN D	39
54	731617114061	NANDHAKUMAR G	40
55	731617114062	NARESH M	45
56	731617114063	NAVEEN M	42
57	731617114064	NAVEEN V	45
58	731617114065	NIKHIL S	40
59	731617114067	PAVITHRAN G	42
60	731617114069	PRADEEP N	43
61	731617114070	PRADHAP R	45
62	731617114071	PRAGATHEESWAR E	42
63	731617114072	PRASATH R	39
64	731617114073	PRATHIYUMANAN M	45
65	731617114074	PRAVEEN H	40
66	731617114075	PRAVEENKUMAR V	39
67	731617114076	PRAVEEN KUMAR S	38
68	731617114077	PREMRAJ S	40
69	731617114078	RAHUL V	35
70	731617114079	RAMKUMAR B	36
71	731617114080	RANJITHKUMAR K	35
72	731617114081	SABARINATHAN S	46
73	731617114082	SAKTHIVEL P	45
74	731617114083	SANTHOSHKUMAR G	40
75	731617114085	SARATH KUMAR M	39
76	731617114086	SARAVANAA M	37
77	731617114087	SARAVANAN R	38
78	731617114088	SASIKARAN S	35
79	731617114089	SATHISHKUMAR S	36
80	731617114091	SRIDHAR C	40
81	731617114092	SRIDHARAN R	42
82	731617114093	SURENDHAR P	40
83	731617114094	SURESHKUMAR A	43
84	731617114095	SURESHMOORTHY P	45
85	731617114096	SURYAMOORTHY R	35
86	731617114098	TAMILSELVAN V	39
87	731617114099	THAMIL SELVAM B	40
88	731617114100	THIRUPATHI M	45
89	731617114101	THULASI RAMAN R	42
90	731617114102	VIGNESH R	45
91	731617114103	VIGNESHWARAN S	40
92	731617114104	VIJAYAKUMAR C	42
93	731617114105	VINITH D	43
94	731617114106	VINOTH KUMAR T	45
95	731617114107	YASWANTHKARTHIK S	42
96	731617114108	YOGESH N	39
97	731617114302	DHINESHWARAN G	45
98	731617114303	HARIPRASATH M	40
99	731617114304	KANNAN E	39
100	731617114305	MANIKANDAN V	38
101	731617114306	NANTHAKUMAR P	42
Course Coordinator			
HoD			

Dr. M. VENKATESAN, M.E., Ph.D.
PRINCIPAL,
K S R INSTITUTE FOR
ENGINEERING AND TECHNOLOGY
K.S.R. KALVI NAGAR,
TIRUCHENGODE-637 215,
NAMAKKAL Dt., TAMIL NADU.



K S R INSTITUTE FOR ENGINEERING AND TECHNOLOGY
Tiruchengode, Namakkal – 637215
(Accredited by NBA, Affiliated to Anna University, Chennai)

Department of Mechanical Engineering

Value Added Course - AutoCAD

Date : 01/08/18

FEEDBACK FORM

Tick the Appropriate Columns:

Parameter	Excellent	Very Good	Good	Satisfactory
Content Delivered	/			
Registration		/		
Program Management	/	/		
Hospitality		/		
About Campus	/			

Participant Name: S. Balaji

Suggestions for Improvement:

Signature of the Participant
S. Balaji

Dr. M. VENKATESAN, M.E., Ph.D.,
PRINCIPAL,
K S R INSTITUTE FOR
ENGINEERING AND TECHNOLOGY,
K.S.R. KALVI NAGAR,
TIRUCHENGODE-637 215,
NAMAKKAL Dt, TAMIL NADU.



K S R INSTITUTE FOR ENGINEERING AND TECHNOLOGY
Tiruchengode, Namakkal – 637215
(Accredited by NBA, Affiliated to Anna University, Chennai)

Department of Mechanical Engineering

Value Added Course - AutoCAD

Date : 01/08/18

FEEDBACK FORM

Tick the Appropriate Columns:

Parameter	Excellent	Very Good	Good	Satisfactory
Content Delivered	✓			
Registration		✓		
Program Management	✓			
Hospitality		✓		
About Campus	✓			

Participant Name: Ajith R

Suggestions for Improvement:

Signature of the Participant

Dr., M. VENKATESAN, M.E., Ph D.,
PRINCIPAL,
K S R INSTITUTE FOR
ENGINEERING AND TECHNOLOGY,
K.S.R. KALVI NAGAR,
TIRUCHENGODE-637 215,
NAMAKKAL Dt, TAMIL NADU.

K S R INSTITUTE FOR ENGINEERING AND TECHNOLOGY

TIRUCHENGODE – 637 215

DEPARTMENT OF MECHANICAL ENGINEERING

VALUE ADDED / SHORT TERM COURSE – SUMMARY

Academic Year: 2018-19 (ODD)

Name of the course	Value Added / Short Term course on AUTOCAD
Course Contents	➤ Enclosed
Course Outcomes	<ul style="list-style-type: none">➤ Evaluate mechanical designs and select the proper process and materials for production.➤ Create 2D and 3D computer drawings and models for manufacturing and prototyping.➤ Evaluate computer aided design models and assemblies based on critical thinking and problem solving skills.➤ Collaborate with people of diverse backgrounds and abilities.➤ Develop a solution through group work.➤ Communicate and present ideas and solutions to design problems.
Program Outcomes & Program Specific Outcomes	PO1,PO3,PO4,PO5,PO6,PO9,P10,PO12, PSO2
Course Convener	Dr.P.Murugesan, HoD/MECH
Course Coordinators	Mr.S.Ponnusamy AP/MECH
Resource Persons	Mr S.Mohanavelan AP / MECH Mr M.Sambath Kumar AP / MECH Mr A.Premkumar AP / MECH Mr K.Gopalakrishnan AP / MECH
Duration & Dates	38 Hours & 02/07/2018 to 01/08/2018
Participants & Strength	II YEAR MECH KSRIET STUDENTS & 101

Coordinator



Convener

Dr. M. VENKATESAN, M.E., Ph.D.,
PRINCIPAL,
K S R INSTITUTE FOR
ENGINEERING AND TECHNOLOGY,
K.S.R. KALVI NAGAR,
TIRUCHENGODE-637 215,
NAMAKKAL DI, TAMIL NADU.

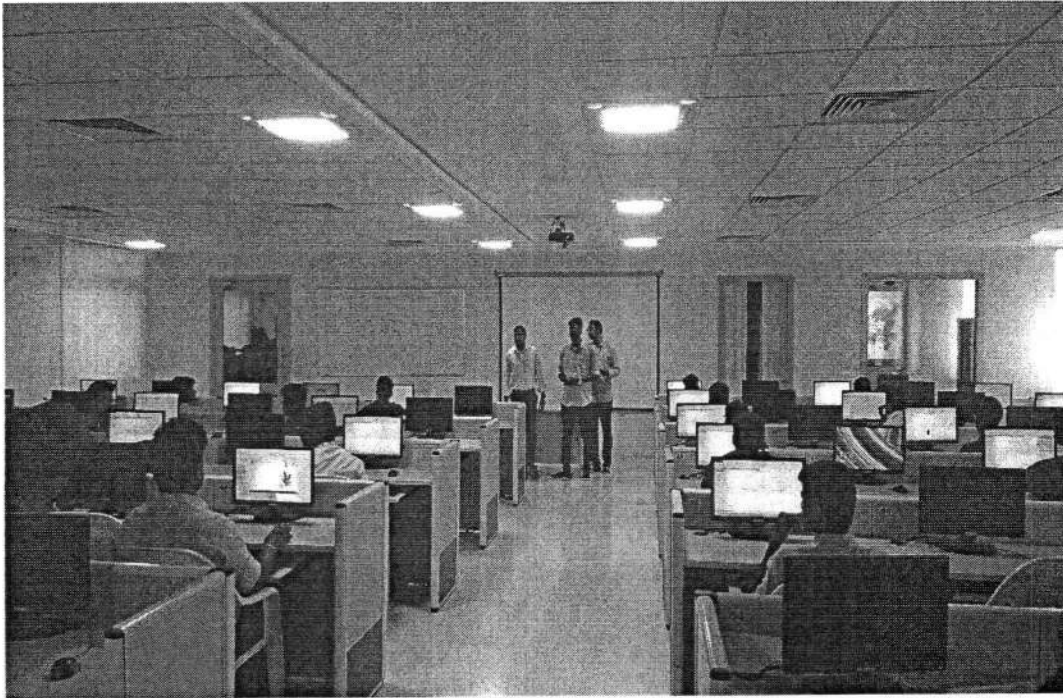
**KSR INSTITUTE FOR ENGINEERING AND TECHNOLOGY
DEPARTMENT OF MECHANICAL ENGINEERING**

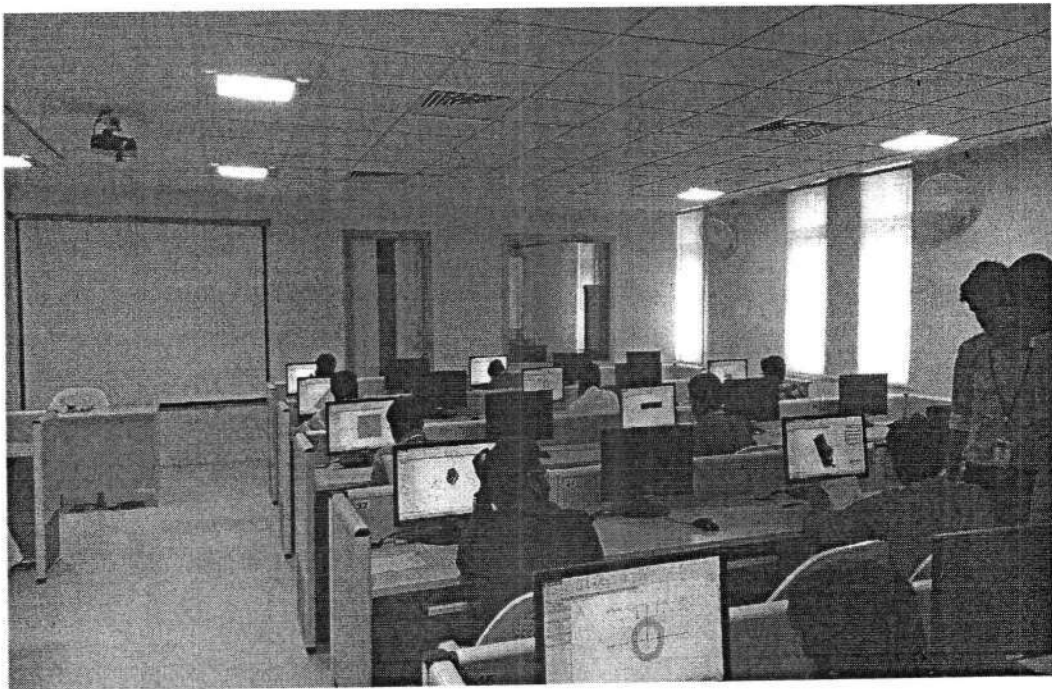

VALUE ADDED COUSE AUTOCAD II YEAR



VALUE ADDED COUSE AUTOCAD II YEAR

**Dr. M. VENKATESAN, M.E., Ph.D.,
PRINCIPAL,
K S R INSTITUTE FOR
ENGINEERING AND TECHNOLOGY,
K.S.R. KALVI NAGAR,
TIRUCHENGODE-637 215,
NAMAKKAL DI, TAMIL NADU**



**K S R INSTITUTE FOR ENGINEERING & TECHNOLOGY,
TIRUCHENGODE**

(APPROVED BY AICTE, NEW DELHI AND AFFILIATED TO ANNA UNIVERSITY, CHENNAI)

**DEPARTMENT OF MECHANICAL ENGINEERING
CENTRE FOR VALUE ADDED EDUCATION
(CENVAE)**

VALUE ADDED COURSE - AUTOCAD

CERTIFICATE OF PARTICIPATION

This is to certify that Mr. /Ms. B. Gopiraj of 10 YEARS
Department of Mechanical Engineering, K S R INSTITUTE FOR
ENGINEERING AND TECHNOLOGY has attended value added course on
"AUTOCAD" organized by the Department of Mechanical Engineering,
K S R IET from 02/07/18 to 01/08/18.

COURSE COORDINATOR

HOD



M. VENKATESH, M.E., PH.D.
PRINCIPAL

TIRUCHENGODE-637 215,
NAMARKAL Dt, TAMIL NADU.



K S R INSTITUTE FOR ENGINEERING AND TECHNOLOGY
Tiruchengode, Namakkal – 637215

Department of Mechanical Engineering

Value Added Course – Syllabus

The course covers the topics you need to review for the Creo for Industrial Design including:

Module 1: INTRODUCTION TO CREO PARAMETRIC

7

Introduction to Creo Parametric Feature-Based Nature Bidirectional Associative Property Parametric Nature System Requirements Getting Started with Creo Parametric- Important Terms and Definitions File Menu Options- Managing Files- Menu Manager Model Tree -Understanding the Functions of the Mouse Buttons- Ribbon Toolbars Navigator

Module 2: CREATING SKETCHES IN THE SKETCH MODE

8

The Sketcher Environment-Working with a Sketch in the Sketch Mode-Drawing a Sketch Using tools available in the Sketch Tab-Dimensioning the Sketch-Dimensioning the Basic Sketched Entities-Working with Constraints-Resolve Sketch Dialog Box- Deleting the Sketched Entities - Trimming the Sketched Entities- Mirroring the Sketched Entities.

Module 3: OPTIONS AIDING CONSTRUCTION OF PARTS

8

Options Aiding Construction of Parts-Creating Holes-Creating Rounds-Creating Chamfers-Understanding Ribs-Editing Features of a Model-Creating Feature Patterns-Copying Features- Mirroring a Geometry-Creating a Section of a Solid Model

Module 4: ASSEMBLY MODELING

9

Assembly Modelling -Important Terms Related to the Assembly Mode-Creating Top-down Assemblies-Creating Bottom-up Assemblies-Assembling Components-Modifying the Components of an Assembly-Creating the Exploded State

Module 5: SURFACE MODELING

10

Surface Modelling-Creating Surfaces in Creo Parametric-Creating Surfaces the 'Using the Style Environment of Creo Parametric-Surface Editing Tools Mirroring-Freestyle modelling environment- Invoking the Sheet metal Mode-Introduction to Sheet metal Walls-Creating the Bend Feature Creating the Unbend Feature

Total: 43 Hours

COORDINATOR

Dr. M. VENKATESAN, M.E., Ph.D.,
PRINCIPAL,
K S R INSTITUTE FOR
ENGINEERING AND TECHNOLOGY,
K.S.R. KALVI NAGAR,
TIRUCHENGODE-637 215
NAMAKKAL Dt. TAMIL NADU



K S R INSTITUTE FOR ENGINEERING AND TECHNOLOGY
Tiruchengode, Namakkal – 637215

Department of Mechanical Engineering

Value Added Course – CREO FOR INDUSTRIAL DESIGN

Schedule

Date: 28/05/2018

S.No.	Date	Topic	Name of the Faculty
1.	04/06/18	Introduction to Creo Parametric Feature-Based Nature Bidirectional Associative Property Parametric Nature System Requirements Getting Started with Creo Parametric-Important Terms and Definitions File Menu Options-Managing Files- Menu Manager Model Tree -Understanding the Functions of the Mouse Buttons- Ribbon Toolbars Navigator	Mr.P.Chakravarthi & Mr.G.Gowrisankar
2.	05/06/18	The Sketcher Environment-Working with a Sketch in the Sketch Mode-Drawing a Sketch Using tools available in the Sketch Tab-Dimensioning the Sketch-Dimensioning the Basic Sketched Entities-Working with Constraints-Resolve Sketch Dialog Box- Deleting the Sketched Entities - Trimming the Sketched Entities- Mirroring the Sketched Entities..	Mr.S.Balamurugan& Mr.K.Velusamy
3.	06/06/18	Options Aiding Construction of Parts-Creating Holes-Creating Rounds-Creating Chamfers-Understanding Ribs-Editing Features of a Model-Creating Feature Patterns-Copying Features-Mirroring a Geometry-Creating a Section of a Solid Model	Mr.P.Chakravarthi& Mr.G.Gowrisankar
4.	07/06/18	Assembly Modelling -Important Terms Related to the Assembly Mode-Creating Top-down Assemblies-Creating Bottom-up Assemblies-Assembling Components-Modifying the Components of an Assembly-Creating the Exploded State	Mr.S.Balamurugan& Mr.K.Velusamy
5.	08/06/18	Surface Modelling-Creating Surfaces in Creo Parametric-Creating Surfaces the Using the Style Environment of Creo Parametric-Surface Editing Tools Mirroring-Freestyle modelling environment-Invoking the Sheet metal Mode-Introduction to Sheet metal Walls-Creating the Bend Feature Creating the Unbend Feature	Mr.P.Chakravarthi& Mr.G.Gowrisankar

COORDINATOR

HOD

Dr. M. VENKATESAN, M.E., Ph.D.,
 PRINCIPAL,
 K S R INSTITUTE FOR
 ENGINEERING AND TECHNOLOGY,
 K.S.R. KALVI NAGAR,
 TIRUCHENGODE-637 215,
 NAMAKKAL DI. TAMIL NADU

K S R Institute for Engineering and Technology
Department of Mechanical Engineering
Value Added Course on CREO FOR INDUSTRIAL DESIGN
Year:III

Attendance

Academic Year: 2018-19

S.NO	REG.NO	NAME OF THE STUDENT	04.06.18	05.06.18	06.06.18	07.06.18	08.06.18
1	731616114001	Aakash S	/	/	/	/	/
2	731616114002	Ajith M	/	A	/	/	/
3	731616114003	Annamalai K	/	/	/	/	/
4	731616114004	Arshath S	/	/	/	/	/
5	731616114005	Aswinkumar S	/	/	/	/	/
6	731616114006	Bharath V	/	/	/	/	A
7	731616114007	Boopathi Raja E	/	/	/	/	/
8	731616114008	Boopathy K M	/	/	/	/	/
9	731616114010	Chellathurai T	/	/	/	/	/
10	731616114011	Deepak R	/	/	/	/	/
11	731616114012	Dhayanidhi M	/	/	/	/	/
12	731616114013	Dhevendran E	/	/	/	/	/
13	731616114014	Dhinakaran P	/	/	/	/	/
14	731616114015	Dinesh Kumar C	/	/	/	/	/
15	731616114016	Gokul R	/	/	/	/	/
16	731616114017	Gokulraj P	/	/	/	/	/
17	731616114018	Gopinath G	/	/	/	/	/
18	731616114019	Govindasamy A	/	/	/	/	/
19	731616114020	Gowtham P	/	/	A	/	/
20	731616114021	Gunasekaran R	/	/	/	/	/
21	731616114022	Hariharan M	/	/	/	/	/
22	731616114023	Hariharan S	/	/	/	/	/
23	731616114025	Inbarasan C	/	/	/	/	/
24	731616114027	Jayamurugan K S	/	/	/	/	/
25	731616114028	Jeeva K	/	/	/	/	A
26	731616114029	Jeeva M	/	/	/	/	/
27	731616114030	Jestinraj K	/	/	/	/	/
28	731616114031	Joshua Y	/	/	/	/	/
29	731616114032	Kaleswaran D	A	/	/	/	/
30	731616114033	Karole Infanto D	/	/	/	/	/
31	731616114034	Karthikeyan P	/	/	/	/	/
32	731616114035	Kavin P	/	/	/	/	/
33	731616114036	Kavinkumar R	/	/	/	/	/
34	731616114037	Keerthivasan S	/	/	/	/	/
35	731616114038	Kesav Goutham N B	/	/	/	A	/
36	731616114040	Kirubakaran M	/	/	/	/	/
37	731616114041	Lakshmi Narayanan R	/	/	/	/	/
38	731616114042	Logesh N	/	/	/	/	/
39	731616114043	Logesh S	/	A	/	/	/
40	731616114045	Mageswaran A	/	/	/	/	/
41	731616114046	Manikandan V	/	/	/	/	/
42	731616114047	Manojkumar K	/	/	/	/	/
43	731616114048	Mohammed Nihal R	/	/	/	/	/
44	731616114049	Mohanakrishnan D	/	/	/	/	/
45	731616114050	Mohan Arjun Kumaravel	/	/	/	/	/
46	731616114051	Mohanraj B	/	/	/	/	/
47	731616114302	balaji M	/	/	/	/	/
48	731616114303	Barath V	A	/	/	/	/
49	731616114304	Ethayakumar G	/	/	/	/	/

Dr..M. VENKATESAN, M.E., Ph.D.,
 PRINCIPAL,
 K S R INSTITUTE FOR
 ENGINEERING AND TECHNOLOGY,
 K.S.R. KALVI NAGAR,
 TIRUCHENGODE-637 213,
 KANNIYAKUMAR DISTRICT, TAMIL NADU

S.NO	REG.NO	NAME OF THE STUDENT	04.06.18	05.06.18	06.06.18	07.06.18	08.06.18
50	731616114305	Jeevanandham N	/	/	/	/	/
51	731616114306	Karthi S	/	/	/	/	/
52	731616114308	Prasanth S	/	/	/	/	/
53	731616114052	Nambiraj J	/	/	/	/	/
54	731616114053	Nandhagobal S	/	/	/	/	/
55	731616114054	Navinkumar M	/	/	/	/	/
56	731616114055	Parthasarathy R	/	/	/	/	/
57	731616114056	Prabakaran S	/	/	/	/	/
58	731616114057	Prabhakaran M	/	/	/	/	/
59	731616114059	Praveen R (07-01-1999)	/	/	/	/	/
60	731616114060	Praveen R (31-03-1999)	/	/	/	/	/
61	731616114061	Praveenkumar S	/	/	/	/	/
62	731616114062	Prem Kumar K R	/	/	/	/	/
63	731616114063	Ragavendhar S	/	/	/	/	/
64	731616114064	Rahul C	/	/	/	/	/
65	731616114065	Rajkumar S	/	/	/	/	/
66	731616114066	Ranjith R	/	/	/	/	/
67	731616114067	Ranjithkumar R	/	/	/	/	/
68	731616114068	Ranjith Kumar V	/	/	/	/	/
69	731616114069	Ravichandran S	/	/	/	/	/
70	731616114070	Riyaz Ahamed S	/	/	/	/	/
71	731616114071	Ruthrannan B	/	/	/	/	/
72	731616114072	Sabarish R	/	/	/	/	/
73	731616114073	Sakthi Gnanasundaram R H	/	/	/	/	/
74	731616114075	Sanjay Kumar S	/	/	/	/	/
75	731616114076	Sanjay Kumar S K	/	/	/	/	/
76	731616114077	Santhoshkumar B	/	/	/	/	/
77	731616114078	Santhoshkumar V	/	/	/	/	/
78	731616114079	Saran K	/	/	/	/	/
79	731616114080	Saranraj S	/	/	/	/	/
80	731616114081	Sathish G	/	/	/	/	/
81	731616114082	Shakthi R M	/	/	/	/	/
82	731616114083	Sowndhar A	/	/	/	/	/
83	731616114084	Surya R	/	/	/	/	/
84	731616114085	Tamilmugilan N	/	/	/	/	/
85	731616114086	Thamocharan J	/	/	/	/	/
86	731616114087	Thirumurugan V	/	/	/	/	/
87	731616114088	Uthaya Kumar M	/	/	/	/	/
88	731616114089	Vasanth S	/	/	/	/	/
89	731616114090	Vasantha Kumar P	/	/	/	/	/
90	731616114091	Velmurugan T	/	/	/	/	/
91	731616114092	Vignesh B	/	/	/	/	/
92	731616114093	Vignesh V	/	/	/	/	/
93	731616114094	Vijay Anand G	/	/	/	/	/
94	731616114095	Vijayaragavan P	/	/	/	/	/
95	731616114096	Vinothmani M	/	/	/	/	/
96	731616114097	Vishnu A	/	/	/	/	/
97	731616114098	Vivek P	/	/	/	/	/
98	731616114099	Yogaraj G	/	/	/	/	/
99	731616114100	Yogesh T	/	/	/	/	/
100	731616114309	SANJEEV.K.P	/	/	/	/	/
101	731616114310	SHANMUGA MANIVEL	/	/	/	/	/
102	731616114311	SURENDHARAN.J	/	/	/	/	/
Course Coordinator			/	/	/	/	/
HoD			/	/	/	/	/

Dr., M. VENKATESAN, M.E., Ph.D.

PRINCIPAL,

K S R INSTITUTE FOR
ENGINEERING AND TECHNOLOGY,

K.S.R. KALVI NAGAR,

TIRUCHENGODE-637 315

NAMAKKAL DISTRICT, TAMIL NADU.

KSR INSTITUTE FOR ENGINEERING AND TECHNOLOGY
DEPARTMENT OF MECHANICAL ENGINEERING
Centre of value added education
Assessment Test
CREO FOR INDUSTRIAL DESIGN

Date: 08/06/18

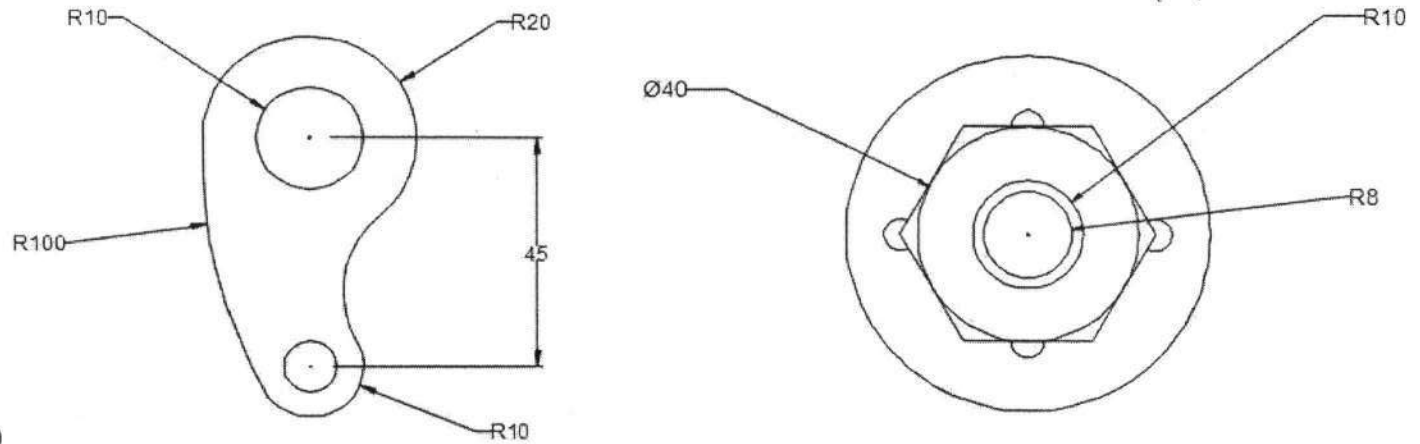

Mark =50

ALL DIMENSIONS ARE IN MM

M. VENKATESAN, M.E., Ph.D.
PRINCIPAL,
K S R INSTITUTE FOR
ENGINEERING AND TECHNOLOGY,
K.S.R. KALVI NAGAR,
TIRUCHENGODE-637 215,
NAMAKKAL DI, TAMIL NADU.

K S R Institute for Engineering and Technology
Department of Mechanical Engineering
Value Added Course on CREO FOR INDUSTRIAL DESIGN
Year: III Assessment Mark Academic Year:2018-19

S.NO	REG.NO	NAME OF THE STUDENT	Marks(50)
1	731616114001	Aakash S	43
2	731616114002	Ajith M	39
3	731616114003	Annamalai K	37
4	731616114004	Arshath S	38
5	731616114005	Aswinkumar S	40
6	731616114006	Bharath V	43
7	731616114007	Boopathi Raja E	39
8	731616114008	Boopathy K M	37
9	731616114010	Chellathurai T	46
10	731616114011	Deepak R	45
11	731616114012	Dhayanidhi M	42
12	731616114013	Dhevendran E	37
13	731616114014	Dhinakaran P	39
14	731616114015	Dinesh Kumar C	35
15	731616114016	Gokul R	40
16	731616114017	Gokulraj P	40
17	731616114018	Gopinath G	35
18	731616114019	Govindasamy A	36
19	731616114020	Gowtham P	39
20	731616114021	Gunasekaran R	42
21	731616114022	Hariharan M	38
22	731616114023	Hariharan S	36
23	731616114025	Inbarasan C	44
24	731616114027	Jayamurugan K S	41
25	731616114028	Jeeva K	40
26	731616114029	Jeeva M	38
27	731616114030	Jestinraj K	36
28	731616114031	Joshua Y	47
29	731616114032	Kaleeswaran D	43
30	731616114033	Karole Infanto D	47
31	731616114034	Karthikeyan P	46
32	731616114035	Kavin P	43
33	731616114036	Kavinkumar R	39
34	731616114037	Keerthivasan S	37
35	731616114038	Kesav Goutham N B	38
36	731616114040	Kirubakaran M	40
37	731616114041	Lakshmi Narayanan R	43
38	731616114042	Logesh N	39
39	731616114043	Logesh S	37
40	731616114045	Mageswaran A	46
41	731616114046	Manikandan V	45
42	731616114047	Manojkumar K	42
43	731616114048	Mohammed Nihal R	35
44	731616114049	Mohanakrishnan D	40
45	731616114050	Mohan Arjun Kumaravel	39
46	731616114051	Mohanraj B	48
47	731616114302	balaji M	39
48	731616114303	Barath V	38
49	731616114304	Ethayakumar G	36
50	731616114305	Jeevanandham N	44
51	731616114306	Karthi S	40
52	731616114308	Prasanth S	38

Dr. M. VENKATESAN, M.E., Ph.D.
PRINCIPAL,
K S R INSTITUTE FOR
ENGINEERING AND TECHNOLOGY,
K.S.R. KALVI NAGAR,
TIRUCHENCODE-637 215,
TAMIL NADU.

S.NO	REG.NO	NAME OF THE STUDENT	Marks(50)
53	731616114052	Nambiraj J	39
54	731616114053	Nandhagobal S	41
55	731616114054	Navinkumar M	44
56	731616114055	Parthasarathy R	40
57	731616114056	Prabakaran S	38
58	731616114057	Prabhakaran M	47
59	731616114059	Praveen R (07-01-1999)	46
60	731616114060	Praveen R (31-03-1999)	43
61	731616114061	Praveenkumar S	38
62	731616114062	Prem Kumar K R	40
63	731616114063	Ragavendhar S	35
64	731616114064	Rahul C	33
65	731616114065	Rajkumar S	41
66	731616114066	Ranjith R	37
67	731616114067	Ranjithkumar R	38
68	731616114068	Ranjith Kumar V	40
69	731616114069	Ravichandran S	43
70	731616114070	Riyaz Ahamed S	39
71	731616114071	Ruthrannan B	37
72	731616114072	Sabarish R	46
73	731616114073	Sakthi Gnanasundaram R H	45
74	731616114075	Sanjay Kumar S	42
75	731616114076	Sanjay Kumar S K	35
76	731616114077	Santhoshkumar B	40
77	731616114078	Santhoshkumar V	39
78	731616114079	Saran K	43
79	731616114080	Saranraj S	39
80	731616114081	Sathish G	38
81	731616114082	Shakthi R M	36
82	731616114083	Sowndhar A	35
83	731616114084	Surya R	36
84	731616114085	Tamilmugilan N	39
85	731616114086	Thamotharan J	38
86	731616114087	Thirumurugan V	40
87	731616114088	Uthaya Kumar M	43
88	731616114089	Vasanth S	39
89	731616114090	Vasantha Kumar P	36
90	731616114091	Velmurugan T	45
91	731616114092	Vignesh B	42
92	731616114093	Vignesh V	41
93	731616114094	Vijay Anand G	39
94	731616114095	Vijayaragavan P	37
95	731616114096	Vinothmani M	48
96	731616114097	Vishnu A	44
97	731616114098	Vivek P	48
98	731616114099	Yogaraj G	47
99	731616114100	Yogesh T	44
100	731616114309	SANJEEV.K.P	40
101	731616114310	SHANMUGA MANIVEL	36
102	731616114311	SURENDHARAN.J	35

Course Coordinator

HoD

Dr., M. VENKATESAN, M.E., Ph.D.,
PRINCIPAL,
K S R INSTITUTE FOR
ENGINEERING AND TECHNOLOGY,
K.S.R. KALVI NAGAR,
TIRUCHENGODE-637 215,
NAMAKKAL Dt, TAMIL NADU.



K S R INSTITUTE FOR ENGINEERING AND TECHNOLOGY
Tiruchengode, Namakkal – 637215

Department of Mechanical Engineering

Value Added Course - Creo for Industrial Design

Date: 08/06/18

FEEDBACK FORM

Tick the Appropriate Columns:

Parameter	Excellent	Very Good	Good	Satisfactory
Content Delivered	✓	X		
Registration		✓		
Program Management	✓			
Hospitality		✓		
About Campus	✓			

Participant Name: R. Govind

Suggestions for Improvement:

Dr. M. VENKATESAN, M.E., Ph.D.,
PRINCIPAL,
K S R INSTITUTE FOR
ENGINEERING AND TECHNOLOGY,
K.S.R. KALVI NAGAR,
TIRUCHENGODE-637 215,
NAMAKKAL Dt, TAMIL NADU

Signature of the Participant

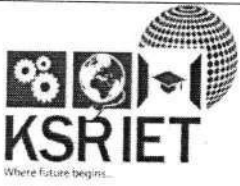

K S R INSTITUTE FOR ENGINEERING AND TECHNOLOGY
Tiruchengode, Namakkal – 637215

Department of Mechanical Engineering

Value Added Course - Creo for Industrial Design

Date: 08/06/18

FEEDBACK FORM

Tick the Appropriate Columns:

Parameter	Excellent	Very Good	Good	Satisfactory
Content Delivered	✓			
Registration	✓			
Program Management		✓		
Hospitality		✓		
About Campus	✓			

Participant Name: Ajjan M

Suggestions for Improvement:

Dr. M. VENKATESAN, M.E., Ph.D
PRINCIPAL,
K S R INSTITUTE FOR
ENGINEERING AND TECHNOLOGY
K.S.R. KALVI NAGAR,
TIRUCHENGODE-637 215,
NAMAKKAL Dt. TAMIL NADU.

Signature of the Participant

K S R INSTITUTE FOR ENGINEERING AND TECHNOLOGY

TIRUCHENGODE – 637 215

DEPARTMENT OF MECHANICAL ENGINEERING

VALUE ADDED / SHORT TERM COURSE – SUMMARY

Academic Year: 2018-19 (ODD)

Name of the course	Five days Value Added / Short Term course on CREO FOR INDUSTRIAL DESIGN
Course Contents	➤ Enclosed
Course Outcomes	<ul style="list-style-type: none">➤ Student will have seamless data sharing ability; they can easily design entire process, from concept design work to manufacturing the final product.➤ Student can automatically do associative manufacturing and service deliverables generation.➤ Student can add manufacturing businesses transition into model-based enterprises.➤ Student will have enough skills to increase productivity, do better concept design, increase engineering & manufacturing capabilities, do better simulation and additive manufacturing.
Program Outcomes & Program Specific Outcomes	PO1,PO3,PO4,PO5,PO6,PO9,P10,PO12, PSO2
Course Convener	Dr.P.MURUGESAN, HoD/MECH
Course Coordinators	Mr.S.Ponnusamy AP/MECH
Resource Persons	Mr.P.Chakravarthi AP/MECH Mr.G.Gowrisankar AP/MECH Mr.S.Balamurugan AP/MECH Mr.K.Velusamy AP/MECH
Duration & Dates	Five days (38 Hours) & 04/06/2018 to 08/06/2018
Participants & Strength	III YEAR MECH KSRIET STUDENTS & 102

Coordinator

Dr. M. VENKATESAN, M.E., Ph.D.,
PRINCIPAL,
K S R INSTITUTE FOR
ENGINEERING AND TECHNOLOGY,
K.S.R. KALVI NAGAR,
TIRUCHENGODE-637 215,
NAMAKKAL DI, TAMIL NADU.

Convener

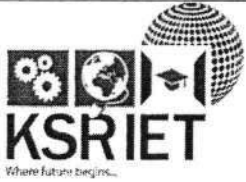

K S R INSTITUTE FOR ENGINEERING AND TECHNOLOGY
Tiruchengode, Namakkal – 637215
Department of Mechanical Engineering

&



UNITED CADD SOLUTION Private Limited



SOLIDWORKS SYLLABUS

S.NO	TOPICS	No.of hours
1	Introduction	8
2	Sketcher	
3	Base Features	
4	Reference Features	
5	Engineering Features	12
6	Special Features	
7	Advanced Modeling	
8	Base Features	
9	Special Features	8
10	Advance features	
11	Applying standard mates	
12	Applying advanced mates	
13	Applying mechanical mates	12
14	Creating features	
15	Editing features	
16	Generating Drawing Views	
17	Inserting Annotations	

Total Period: 40

COORDINATOR

Dr. M. VENKATESAN, M.E., Ph.D.,
PRINCIPAL,
K S R INSTITUTE FOR
ENGINEERING AND TECHNOLOGY
K.S.R. KALVI NAGAR,
TIRUCHENGODE-637 215,
NAMAKKAL DL, TAMIL NADU.



K S R INSTITUTE FOR ENGINEERING AND TECHNOLOGY
Tiruchengode, Namakkal – 637215.

Department of Mechanical Engineering

**Six Days Value Added Course – SOLID WORKS
Schedule**

Date: 20/05/2018

S.No.	Date	Topic	Name of the Faculty
1.	28/05/18	Introduction About Solid Works, Various products available in SolidWorks for Product Design, Simulation, Communication Keyboard shortcuts, Command Manager, Hardware and Software requirements, SolidWorks Task Scheduler	Mr.S.Mohanavelan & Mr.A.Premkumar
2.	29/05/18	Sketch Entities – Inference line, Centerline line, Line, Circle, Arc, Ellipse, Rectangle, Slots, Polygon, Parabola, Ellipse, Partial Ellipse, Spline, Spline tools, Spline on surface, Equation driven curve, Points, Text, Construction geometry, Snap, grid	Dr.R.Rameshkumar & Mr.P.Karthick
3.	30/05/18	Sketch Tools - Construction Geometry, Mirror, Dynamic Mirror, Move, Copy, Rotate, Scale, Stretch, Sketch pattern , Polygon, Make path, Close Sketch To Model, Tools Creating reference planes Creating Extrude features – Direction1, Direction2, From option, Thin feature, Applying draft, Selecting contours	Mr.S.Mohanavelan & Mr.A.Premkumar
4.	31/05/18	Creating Revolve features – Selecting Axis, Thin features, Selecting contours Creating Swept features-Selecting, Profile and Path, Orientation/twist type, Path Alignment, Guide Curves, Start/End tangency, Thin feature, Assembly Modeling Modeling & Approaches – Top down and Bottom up approach, Applying Advanced Mates – Symmetric, Width, Path Mate, Linear/Linear Coupler, Limit Mate. Applying Mechanical Mates – Cam, Hinge, Gear, Rack Pinion, Screw, Universal Joint.	Dr.R.Rameshkumar & Mr.P.Karthick
5.	01/06/18	Manipulating Components - Replacing Components, Rotating Components, Move Components, Collision Detection, Physical Dynamics, Dynamic Clearance, Detecting Interference, Surface Modeling tools Creating Extrude, Revolve, Swept, loft, Boundary surface.	Mr.S.Mohanavelan & Mr.A.Premkumar
6.	02/06/18	Inserting Planar Surface, Offset Surface, Radiate Surface. Sheet Metal Design Concepts in Sheet metal design bend allowance bend deduction, Inserting Base Flange, Sheet Metal Tab, Edge Flange, Miter Flange, Hem, Jog. Creating Break Corner/Corner Trim, Closed Corners Rip.	Dr.R.Rameshkumar & Mr.P.Karthick

Faculty Incharge

Dr. M. VENKATESAN, M.E., Ph.D.,
PRINCIPAL,
K S R INSTITUTE FOR
ENGINEERING AND TECHNOLOGY,
K.S.R. KALV NAGAR,
TIRUCHENGODE-637 215,
NAMAKKAL DISTRICT, TAMIL NADU.

HOD

K S R Institute for Engineering and Technology

Department of Mechanical Engineering

Value Added Course on SOLIDWORKS

Year:IV

Attendance

Academic Year:2018-19

S.NO	REG.NO	NAME OF THE STUDENT	28.05.18	29.05.18	30.05.18	31.05.18	01.06.18	02.06.18
1	731615114004	AJITHKUMAR S	/	/	/	/	/	/
2	731615114005	AJITH KUMAR S	/	/	/	/	/	/
3	731615114006	AKILAN M	/	/	/	/	/	/
4	731615114007	ALEXANDER M	/	/	/	/	/	/
5	731615114010	ARAVINTHASAMY B	/	/	/	/	/	/
6	731615114011	ARUN KUMAR S	/	/	/	/	/	/
7	731615114014	BALAJI M	/	/	/	/	/	/
8	731615114015	BALAJI M	/	/	/	/	/	/
9	731615114021	BHARATHI K N	/	/	/	/	/	/
10	731615114022	BHARATH KUMAR S	/	/	/	/	/	/
11	731615114024	BOOPATHIRAJA S	/	/	/	/	/	/
12	731615114027	DEENADHAYALAN P	/	/	/	/	/	/
13	731615114029	DHANASEKAR R	/	/	/	/	/	/
14	731615114033	DHINESHRAJ L	/	/	/	/	/	/
15	731615114034	DINESH J	/	/	/	/	/	/
16	731615114035	DINESH K	/	/	/	/	/	/
17	731615114037	DINESHKUMAR B	/	/	/	/	/	/
18	731615114039	DUDIARASU S	/	/	/	/	/	/
19	731615114040	ELANGO V	/	/	/	/	/	/
20	731615114041	ELANTHENDRAL R M	/	/	/	/	/	/
21	731615114042	GABY SACHIN S	A	A	A	A	A	A
22	731615114043	GIRI K	/	/	/	/	/	/
23	731615114047	GOKUL P	/	/	/	/	/	/
24	731615114048	GOKUL MAYURA PRIYAN B	/	/	/	/	/	/
25	731615114050	GOPIKA R	/	/	/	/	/	/
26	731615114051	GOWTHAM K	/	/	/	/	/	/
27	731615114052	HARIPRASATH S	/	/	/	/	/	/
28	731615114053	HARIRAJ K	/	/	/	/	/	/
29	731615114054	HRITHWIK RAJEEV	/	/	/	/	/	/
30	731615114057	JAGADEESHBABU K	/	/	/	/	/	/
31	731615114058	JAGADESHWARAN S	/	/	/	/	/	/
32	731615114098	NISHANTHI B	/	/	/	/	/	/
33	731615114061	KANNAN P	/	/	/	/	/	/
34	731615114062	KARTHICK R	/	/	/	/	/	/
35	731615114063	KARTHIKEYAN A	/	/	/	/	/	/
36	731615114068	KISHORE M	/	/	/	/	/	/
37	731615114069	KISHORE KUMAR M	/	/	/	/	/	/
38	731615114070	KUMAR P	/	/	/	/	/	/
39	731615114071	LINGESWAR M	/	/	/	/	/	/
40	731615114072	LOGANATHAN K	/	/	/	/	/	/
41	731615114081	MANOKARAN P	A	A	A	A	A	A
42	731615114082	MOHAMMED EHIYA S	/	/	/	/	/	/
43	731615114083	MOHANKUMAR R	/	/	/	/	/	/
44	731615114087	NANDHAKUMAR.S (6/10/97)	/	/	/	/	/	/
45	731615114089	NARENDHIRAN M	/	/	/	/	/	/
46	731615114090	NAVANEETHAN R	/	/	/	/	/	/
47	731615114091	NAVEEN M (20/3/97)	/	/	/	/	/	/
48	731615114092	NAVEEN M (20/6/97)	/	/	/	/	/	/

Dr. M. VENKATESAN, M.E., Ph.D.
PRINCIPAL,

K S R INSTITUTE FOR
ENGINEERING AND TECHNOLOGY,
K.S.R. COLLEGE SACAR,
TIRUCHENAI - 637 215,
TAMIL NADU.

S.NO	REG.NO	NAME OF THE STUDENT	28.05.18	29.05.18	30.05.18	31.05.18	01.06.18	02.06.18
49	731615114096	NAVEEN KUMAR N (8.6.98)	/	/	/	/	/	/
50	731615114097	NISHANTH E	/	/	/	/	/	/
51	731615114102	PRAKASH R	/	/	/	/	/	/
52	731615114103	PRASANNAKUMAR M	/	/	/	/	/	/
53	731615114110	RAJAMANI M	/	/	/	/	/	/
54	731615114111	RAMANA SARATHI A T	/	/	/	/	/	/
55	731615114115	ROBERT SAM DANIEL	/	/	/	/	/	/
56	731615114305	DINESH S	/	/	/	/	/	/
57	731615114306	ELAVARASAN D	/	/	/	/	/	/
58	731615114308	GOWTHAM V	/	/	/	/	/	/
59	731615114309	KARTHIK G	/	/	/	/	/	/
60	731615114312	MAHESWARAN K	/	/	/	/	/	/
61	731615114501	GOWTHAMRAJ T	/	/	/	/	/	/
62	731615114702	KATHIRAVAN S	/	/	/	/	/	/
63	731615114121	SANTHOSHKUMAR S	/	/	/	/	/	/
64	731615114122	SANTHOSH KUMAR M	/	/	/	/	/	/
65	731615114123	SANTHOSH KUMAR R	/	/	/	/	/	/
66	731615114124	SARAVANAN M	/	/	/	/	/	/
67	731615114125	SASIKUMAR S (28.12.1996)	/	/	/	/	/	/
68	731615114130	SATHISH KUMAR G	/	/	/	/	/	/
69	731615114131	SELVAKUMAR R	/	/	/	/	/	/
70	731615114135	SHREERAM M R	/	/	/	/	/	/
71	731615114136	SHUKEL AHAMED M	/	/	/	/	/	/
72	731615114137	SHYAM SUNDAR S	/	/	/	/	/	/
73	731615114138	SOUNDHIRARAJAN P	/	/	/	/	/	/
74	731615114139	SRIDHAR L	A	A	A	A	A	A
75	731615114142	SUDHARSEN M	/	/	/	/	/	/
76	731615114143	SUGAN A	/	/	/	/	/	/
77	731615114144	SUGANESHWARAN G	/	/	/	/	/	/
78	731615114146	SURYA S C	/	/	/	/	/	/
79	731615114152	UMANATH G	/	/	/	/	/	/
80	731615114156	VENKADESAN I	/	/	/	/	/	/
81	731615114157	VENUGOPAL P	/	/	/	/	/	/
82	731615114158	VIGNESH M	/	/	/	/	/	/
83	731615114159	VIGNESH S (20.03.1997)	/	/	/	/	/	/
84	731615114160	VIGNESH S (01.04.1998)	/	/	/	/	/	/
85	731615114163	VIMALRAJ R	A	A	A	A	A	A
86	731615114164	VINOTH KUMAR P	/	/	/	/	/	/
87	731615114165	VISHNUKUMAR R	/	/	/	/	/	/
88	731615114316	PRAVINTH K	/	/	/	/	/	/
89	731615114317	RADHAKRISHNAN M	/	/	/	/	/	/
90	731615114318	RANJITHKUMAR M	/	/	/	/	/	/
91	731615114319	REVENTHKUMAR S	/	/	/	/	/	/
92	731615114320	SARANKUMAR R	/	/	/	/	/	/
93	731615114321	SENGOTAIIYAN R	/	/	/	/	/	/
94	731615114323	THIRU MOORTHY B	A	A	A	A	A	A
95	731615114701	NAVANEETHAKRISHNAN M	/	/	/	/	/	/
Course Coordinator			/	/	/	/	/	/
HoD			/	/	/	/	/	/

Dr. M. VENKATESAN, M.E., Ph.D.
 PRINCIPAL,
 K. S. R INSTITUTE FOR
 ENGINEERING AND TECHNOLOGY,
 K. S. R. KALVI NAGAR,
 TIRUPATI - 517 215,
 AP.

KSR INSTITUTE FOR ENGINEERING AND TECHNOLOGY
DEPARTMENT OF MECHANICAL ENGINEERING

Centre for Value Added Education (CENVAE)
Assessment Test for Solid Works course
Attend any one question

Date: 2.6.18
MARK (50)

1. Draw the 3D for following diagram

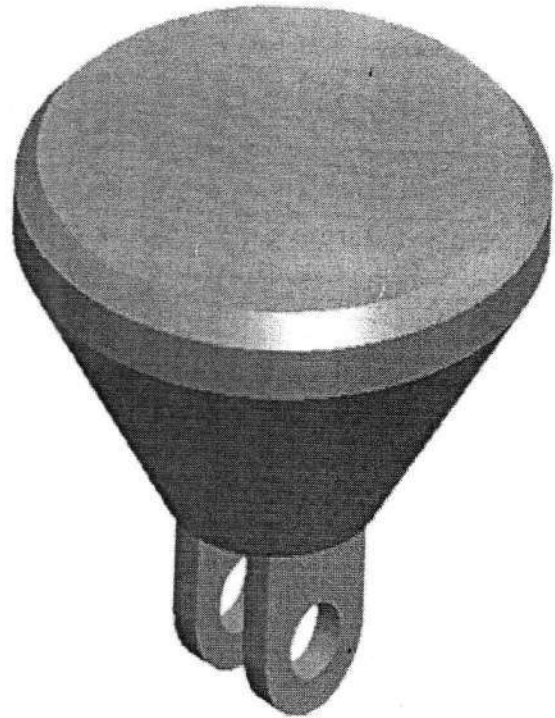
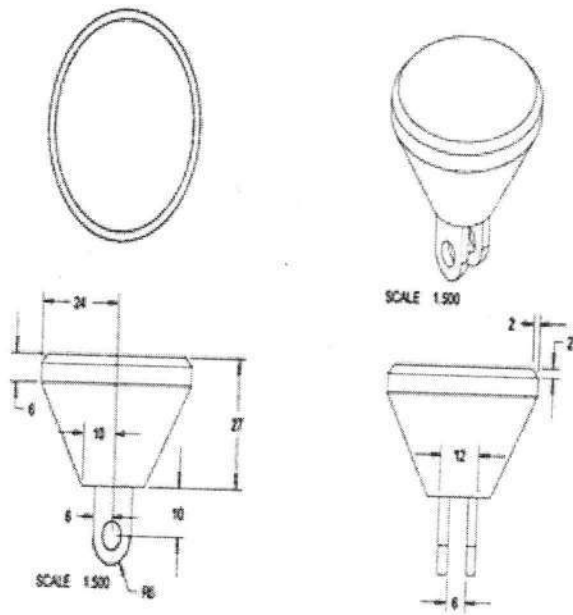

2. Draw the 3D for following diagram

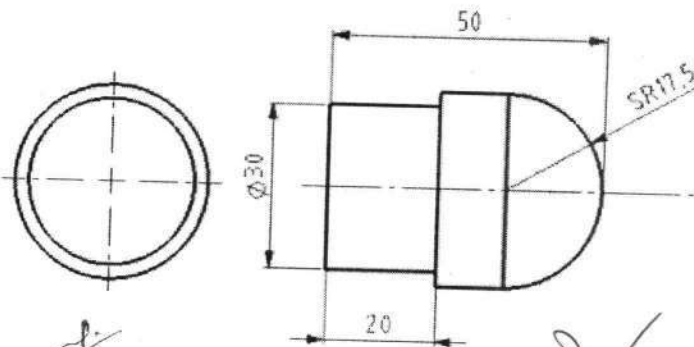
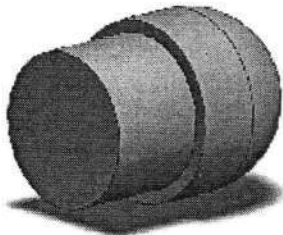

Coordinator

Dr. M. VENKATESAN, M.E., Ph.D.,
PRINCIPAL,
K S R INSTITUTE FOR
ENGINEERING AND TECHNOLOGY,
K.S.R. KALVI NAGAR,
TIRUCHENGODE-637 215,
TAMIL NADU.

HoD

K S R Institute for Engineering and Technology
Department of Mechanical Engineering
Value Added Course on SOLIDWORKS

Year:IV

Assessment

Academic Year:2018-19

S.NO	REG.NO	NAME OF THE STUDENT	MARKS (50)
1	731615114004	AJITHKUMAR S	41
2	731615114005	AJITH KUMAR S	37
3	731615114006	AKILAN M	35
4	731615114007	ALEXANDER M	43
5	731615114010	ARAVINTHASAMY B	39
6	731615114011	ARUN KUMAR S	38
7	731615114014	BALAJI M	36
8	731615114015	BALAJI M	34
9	731615114021	BHARATHI K N	45
10	731615114022	BHARATH KUMAR S	41
11	731615114024	BOOPATHIRAJA S	45
12	731615114027	DEENADHAYALAN P	44
13	731615114029	DHANASEKAR R	41
14	731615114033	DHINESHRAJ L	37
15	731615114034	DINESH J	38
16	731615114035	DINESH K	36
17	731615114037	DINESHKUMAR B	45
18	731615114039	DUDIARASU S	44
19	731615114040	ELANGO V	44
20	731615114041	ELANTHENDRAL R M	36
21	731615114042	GABY SACHIN S	38
22	731615114043	GIRI K	41
23	731615114047	GOKUL P	37
24	731615114048	GOKUL MAYURA PRIYAN B	35
25	731615114050	GOPIKA R	44
26	731615114051	GOWTHAM K	43
27	731615114052	HARIPRASATH S	38
28	731615114053	HARIRAJ K	36
29	731615114054	HRITHWIK RAJEEV	45
30	731615114057	JAGADESHBABU K	44
31	731615114058	JAGADESHWARAN S	40
32	731615114098	NISHANTHI B	44
33	731615114061	KANNAN P	43
34	731615114062	KARTHICK R	40
35	731615114063	KARTHIKEYAN A	36
36	731615114068	KISHORE M	37
37	731615114069	KISHORE KUMAR M	35
38	731615114070	KUMAR P	45
39	731615114071	LINGESWAR M	41
40	731615114072	LOGANATHAN K	43
41	731615114081	MANOKARAN P	41
42	731615114082	MOHAMMED EHIYA S	37
43	731615114083	MOHANKUMAR R	35
44	731615114087	NANDHAKUMAR S (6/10/97)	43
45	731615114089	NARENDHIRAN M	39
46	731615114090	NAVANEETHAN R	38
47	731615114091	NAVEEN M (20/3/97)	36

Dr. M. VENKATESAN, M.E., Ph.D.,
 PRINCIPAL,
 K S R INSTITUTE FOR
 ENGINEERING AND TECHNOLOGY,
 K.S.R. KALVINAGAR,
 TIRUCHENGODE-637 215,
 NAMAKKAL DI, TAMIL NADU.

S.NO	REG.NO	NAME OF THE STUDENT	MARKS (50)
48	731615114092	NAVEEN M (20/6/97)	35
49	731615114096	NAVEEN KUMAR N (8.6.98)	45
50	731615114097	NISHANTH E	41
51	731615114102	PRAKASH R	45
52	731615114103	PRASANNAKUMAR M	44
53	731615114110	RAJAMANI M	41
54	731615114111	RAMANA SARATHI A T	36
55	731615114115	ROBERT SAM DANIEL	42
56	731615114305	DINESH S	40
57	731615114306	ELAVARASAN D	41
58	731615114308	GOWTHAM V	45
59	731615114309	KARTHIK G	43
60	731615114312	MAHESWARAN K	40
61	731615114501	GOWTHAMRAJ T	36
62	731615114702	KATHIRAVAN S	37
63	731615114121	SANTHOSHKUMAR S	39
64	731615114122	SANTHOSH KUMAR M	42
65	731615114123	SANTHOSH KUMAR R	38
66	731615114124	SARAVANAN M	36
67	731615114125	SASIKUMAR S (28.12.1996)	45
68	731615114130	SATHISH KUMAR G	44
69	731615114131	SELVAKUMAR R	40
70	731615114135	SHREERAM M R	44
71	731615114136	SHUKEL AHAMED M	43
72	731615114137	SHYAM SUNDAR S	40
73	731615114138	SOUNDHIRARAJAN P	36
74	731615114139	SRIDHAR L	37
75	731615114142	SUDHARSEN M	35
76	731615114143	SUGAN A	44
77	731615114144	SUGANESHWARAN G	43
78	731615114146	SURYA S C	43
79	731615114152	UMANATH G	35
80	731615114156	VENKADESAN I	36
81	731615114157	VENUGOPAL P	38
82	731615114158	VIGNESH M	41
83	731615114159	VIGNESH S (20.03.1997)	37
84	731615114160	VIGNESH S (01.04.1998)	35
85	731615114163	VIMALRAJ R	44
86	731615114164	VINOTH KUMAR P	43
87	731615114165	VISHNUKUMAR R	38
88	731615114316	PRAVINTH .K	36
89	731615114317	RADHAKRISHNAN M	45
90	731615114318	RANJITHKUMAR .M	44
91	731615114319	REVENTHKUMAR S	40
92	731615114320	SARANKUMAR R	44
93	731615114321	SENGOTAIVAN R	43
94	731615114323	THIRU MOORTHY B	40
95	731615114701	NAVANEETHAKRISHNAN M	36
Course Coordinator			
HoD			

Dr. M. VENKATESAN, M.E., Ph.D
PRINCIPAL,
K S R INSTITUTE FOR
ENGINEERING AND TECHNOLOGY,
K.S.R. KALVI NAGAR,
TIRUCHENGODE-637 215,
NAMAKKAL DISTRICT, TAMIL NADU.



K S R INSTITUTE FOR ENGINEERING AND TECHNOLOGY
Tiruchengode, Namakkal – 637215

Department of Mechanical Engineering

Value Added Course - SOLIDWORKS

Date: 02/06/18

FEEDBACK FORM

Tick the Appropriate Columns:

Parameter	Excellent	Very Good	Good	Satisfactory
Content Delivered	<input checked="" type="checkbox"/>			
Registration	<input checked="" type="checkbox"/>			
Program Management		<input checked="" type="checkbox"/>		
Hospitality	<input checked="" type="checkbox"/>			
About Campus	<input checked="" type="checkbox"/>			

Participant Name: *p kumar*

Suggestions for Improvement:

p-kumar
Signature of the Participant

Dr. M. VENKATESAN, M.E., Ph.D.,
PRINCIPAL,
K S R INSTITUTE FOR
ENGINEERING AND TECHNOLOGY,
K.S.R. KALVI NAGAR,
TIRUCHENGODE-637 215,
NAMAKKAL DI, TAMIL NADU.

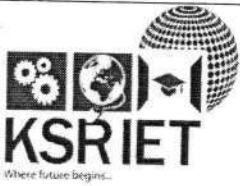

K S R INSTITUTE FOR ENGINEERING AND TECHNOLOGY
Tiruchengode, Namakkal – 637215

Department of Mechanical Engineering

Value Added Course - SOLIDWORKS

Date: 02/06/18

FEEDBACK FORM

Tick the Appropriate Columns:

Parameter	Excellent	Very Good	Good	Satisfactory
Content Delivered	✓			
Registration		✓		
Program Management	✓			
Hospitality		✓		
About Campus	✓			

Participant Name:

Dinesh

Suggestions for Improvement:

Signature of the Participant

f. R. J.

[Signature]

Dr. M. VENKATESAN, M.E., Ph.D.,
PRINCIPAL,
K S R INSTITUTE FOR
ENGINEERING AND TECHNOLOGY,
K.S.R. KALVI NAGAR,
TIRUCHENGODE-637 215,
NAMAKKAL Dt, TAMIL NADU.

K S R INSTITUTE FOR ENGINEERING AND TECHNOLOGY

TIRUCHENGODE – 637 215

DEPARTMENT OF MECHANICAL ENGINEERING

VALUE ADDED / SHORT TERM COURSE – SUMMARY

Academic Year: 2018-19 (ODD)

Name of the course	Six days Value Added / Short Term course on Solid Works
Course Contents	➤ Enclosed
Course Outcomes	<ul style="list-style-type: none">➤ Demonstrate competency with multiple drawing and modification commands in SOLIDWORKS.➤ Create three-dimensional solid models.➤ Create three-dimensional assemblies incorporating multiple solid models.➤ Apply industry standards in the preparation of technical mechanical drawings.➤ Create Simulation of the assemblies incorporating multiple solid models
Program Outcomes & Program Specific Outcomes	PO1,PO3,PO4,PO5,PO6,PO9,P10,PO12, PSO2
Course Convener	Dr.P.Murugesan, HoD/MECH
Course Coordinators	Mr.S.Ponnusamy AP/MECH Dr.R.Rameshkumar AP/MECH
Resource Persons	Mr.S.Mohanavelan AP/MECH Mr.A.Premkumar AP/MECH Dr.R.Rameshkumar AP/MECH Mr.P.Karthick AP/MECH
Duration & Dates	Six days (50 Hours) & 28/05/2018 to 02/06/2018
Participants & Strength	IV YEAR MECH KSRIET STUDENTS & 95

Coordinator



Dr. M. VENKATESAN, M.E., Ph.D.,
PRINCIPAL,
K S R INSTITUTE FOR
ENGINEERING AND TECHNOLOGY,
K.S.R. KALVI NAGAR,
TIRUCHENGODE-637 215,
NAMAKKAL Dt, TAMIL NADU.

Convener

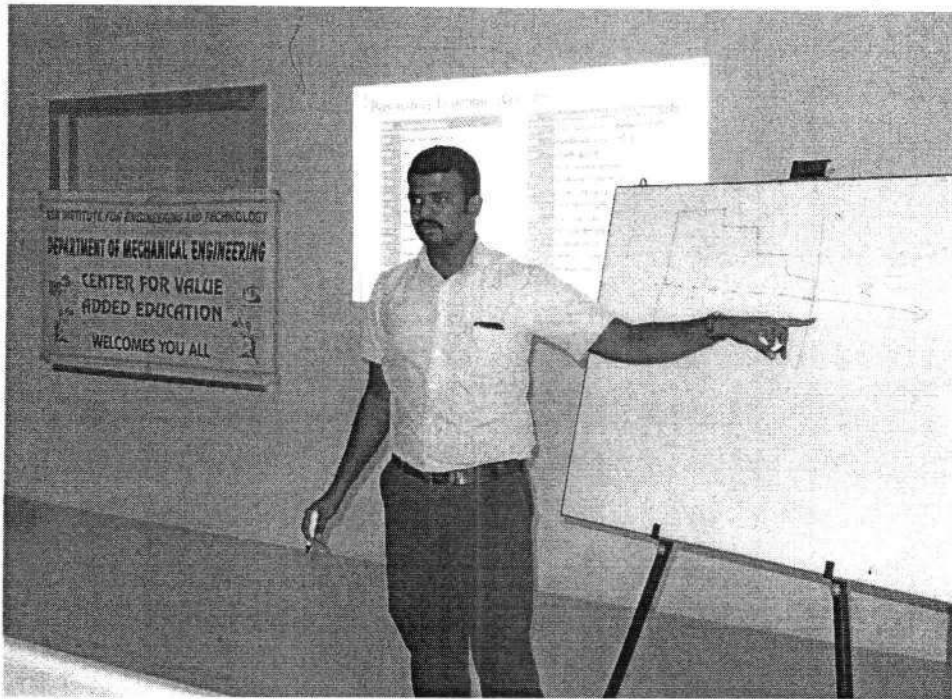
**KSR INSTITUTE FOR ENGINEERING AND TECHNOLOGY
DEPARTMENT OF MECHANICAL ENGINEERING**

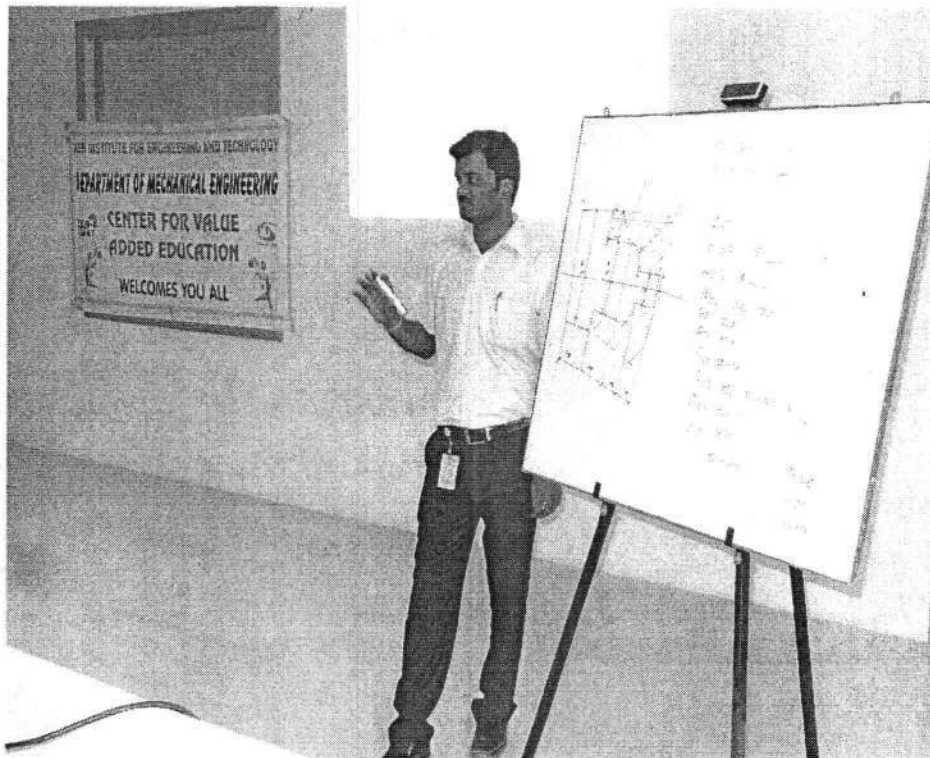

VALUE ADDED COUSE CREO FOR SOLID WORKS



VALUE ADDED COUSE CREO FOR SOLID WORKS

[Signature]
Dr. M. VENKATESAN, M.E., Ph.D.
PRINCIPAL.
K S R INSTITUTE FOR
ENGINEERING AND TECHNOLOGY,
K.S.R. KALVI NAGAR,
TIRUCHENGODE-637 215,
NAMAKKAL DL, TAMIL NADU.

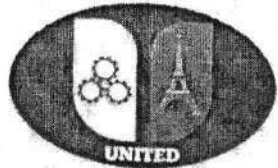

UNITED CADD SOLUTION

Private Limited

Corporate Office : #516/228-D, Annapuram,
Junction Main Road,
Five Roads, Salem, Tamilnadu -636 004.



**KSR Institute For Engineering
& Technology, Tiruchengode.**

www.unitedcaddsolution.com

DESIGN THE FUTURE



CERTIFICATE OF EXCELLENCE

Reg. No. : UCS - KSR0110

Awarded to : RAJAMANI M

in : SOLID WORKS

at : KSRIET

Duration : 40 Hrs

Grade* : H*

Date of Issue : DECEMBER - 2018

*C : 40-50, D : 50-60, A : 60-75, H : Above 75

Course Co-Ordinator

MOD

Dr. M. VENKATESAN, M.E.,
Principal



Director

K S R INSTITUTE FOR
ENGINEERING AND TECHNOLOGY,
ANAPURAM, SALEM, TAMIL NADU.

NAMAKKAL DI, TAMIL NADU.



K S R INSTITUTE FOR ENGINEERING AND TECHNOLOGY
Tiruchengode, Namakkal – 637215
(Accredited by NBA, Affiliated to Anna University, Chennai)
Department of Mechanical Engineering

Value Added Course – Syllabus

The course covers the topics you need to review for the Creo for Automation and production including:

Module 1: Advance Part Modeling

6

Advanced Selection Techniques - Advanced Datum Features - Advanced Sketching Techniques - Create advanced holes - Create advanced drafts and ribs - Create advanced shells - Create advanced rounds and chamfers - Use relations and parameters - Create advanced blends

Module 2: Assembly Design

7

Use advanced component selection - Use advanced assembly constraints - Create and use component interfaces - Utilize intelligent fasteners Extension (IFX) - Create and use flexible components - Restructure and mirror assemblies - Use assembly features and shrink wrap - Replace components in an assembly

Module 3: Creo Simulation & Structural Analysis

8

Introduction to Creo Simulate - Theoretical Foundations - Structural Mechanics - Simulation Models - Explore materials and material properties - Understand and use structural constraints - Understand and use structural loads – Meshing - Understand convergence - Run structural analyses

Module 4: Flexible Modeling

9

Understand Flexible Modeling basics - Apply shape surface selection - Perform flexible transform operations on geometry - Use the various transform options - Attach and remove geometry

Module 5: Behavioural Modeling

8

Apply the behavioral modeling process and concepts - Create measurement analysis features - Creating Model Property Features - Creating Analysis Features - Conducting Design Studies and Optimizing Models.

Total: 38 Hours

Dr. M. VENKATESAN, M.E., Ph.D.,
PRINCIPAL,
K S R INSTITUTE FOR
ENGINEERING AND TECHNOLOGY,
K.S.R. KALVI NAGAR,
TIRUCHENGODE-637 215,
NAMAKKAL DI, TAMIL NADU.

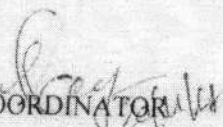
COORDINATOR



K S R INSTITUTE FOR ENGINEERING AND TECHNOLOGY
Tiruchengode, Namakkal – 637215
Department of Mechanical Engineering

Five Days Value Added Course – CREO FOR AUTOMATION AND PRODUCTION

Schedule

Date: 20/12/2018

No.	Date	Topic	Name of the Faculty
1.	10/12/18	Advanced Selection Techniques - Advanced Datum Features - Advanced Sketching Techniques - Create advanced holes - Create advanced drafts and ribs - Create advanced shells - Create advanced rounds and chamfers - Use relations and parameters - Create advanced blends	Mr.A.M.Ramkumar & Mr.S.Baskaran
2.	11/12/18	Use advanced component selection - Use advanced assembly constraints - Create and use component interfaces - Utilize intelligent fasteners Extension (IFX) - Create and use flexible components - Restructure and mirror assemblies - Use assembly features and shrink wrap - Replace components in an assembly	Mr.G.Anitha& Mr.M.Sathish kumar
3.	12/12/18	Introduction to Creo Simulate - Theoretical Foundations - Structural Mechanics - Simulation Models - Explore materials and material properties - Understand and use structural constraints - Understand and use structural loads - Meshing - Understand convergence - Run structural analyses	Mr,A.M.Ramkumar & Mr.S.Baskaran
4.	13/12/18	Understand Flexible Modeling basics - Apply shape surface selection - Perform flexible transform operations on geometry - Use the various transform options - Attach and remove geometry	Mr.G.Anitha& Mr.M.Sathish kumar
5.	14/12/18	Apply the behavioral modeling process and concepts - Create measurement analysis features - Creating Model Property Features - Creating Analysis Features - Conducting Design Studies and Optimizing Models.	Mr.G.Anitha& Mr.M.Sathish kumar

Coordinator

Dr. M. VENKATESAN, M.E., Ph.D.,
 PRINCIPAL,
 K S R INSTITUTE FOR
 ENGINEERING AND TECHNOLOGY,
 K.S.R. KALVI NAGAR,
 TIRUCHENGODE-637 215,
 NAMAKKAL DI. TAMIL NADU.

HOD

K S R Institute for Engineering and Technology
Department of Mechanical Engineering
Value Added Course on CREO AUTOMATION AND PRODUCTION

Year:IV

Attendance

Academic Year:2018-19

S.NO	REG.NO	NAME OF THE STUDENT	10.12.18	11.12.18	12.12.18	13.12.18	14.12.18
1	731615114001	ADHISHANKARAN D	/	/	/	/	/
2	731615114002	AJITH K S	/	/	/	/	/
3	731615114003	AJITH V	/	/	/	/	/
4	731615114008	ARAVINDH P	/	/	/	/	/
5	731615114012	ASHWIN L	/	/	/	/	/
6	731615114013	BALACHANDARAN S	/	/	/	/	/
7	731615114016	BALAJI RAM G	/	/	/	/	/
8	731615114017	BALAKRISHNAN C	/	/	/	/	/
9	731615114018	BALAKUMAR A	/	/	/	/	/
10	731615114019	BENAZIR U	/	/	/	/	/
11	731615114020	BHARATH P	/	/	/	/	/
12	731615114023	BHUVANESHWARAN S	/	/	/	/	/
13	731615114025	CELLAKAMALALAKSHMI R	/	/	/	/	/
14	731615114030	DHANUSH R	/	/	/	/	/
15	731615114032	DHINESH S	/	/	/	/	/
16	731615114038	DINESHKUMAR T	/	/	/	/	/
17	731615114044	GIRIDHARAN B	/	/	/	/	/
18	731615114045	GNANA PRAKASH A S	/	/	/	/	/
19	731615114046	GOBINATH R	/	/	/	/	/
20	731615114055	JACKSON P V	/	/	/	/	/
21	731615114056	JAGADEESH S	/	/	/	/	/
22	731615114301	AJITH M	/	/	/	/	/
23	731615114302	ARUN AAKASH S	/	/	/	/	/
24	731615114060	KABIL L	/	/	/	/	/
25	731615114065	KAVINKUMAR R	/	/	/	/	/
26	731615114066	KAVIPRIYAN S	/	/	/	/	/
27	731615114073	MADHAN KUMAR M	/	/	/	/	/
28	731615114074	MADHUSUDHAN R	/	/	/	/	/
29	731615114075	MANIKANDABOOPATHI B	/	/	/	/	/
30	731615114076	MANIKANDAN G	/	/	/	/	/
31	731615114077	MANIKANDAN P	/	/	/	/	/
32	731615114078	MANIKANDAN S	/	/	/	/	/
33	731615114080	MANOJKUMAR P R	/	/	/	/	/
34	731615114084	MOHANPRABHU K	/	/	/	/	/
35	731615114086	NANDHAKUMAR M	/	/	/	/	/
36	731615114088	NANDHAKUMAR S (22/8/98)	/	/	/	/	/
37	731615114093	NAVEEN N	/	/	/	/	/
38	731615114094	NAVEENKUMAR B	/	/	/	/	/
39	731615114095	NAVEEN KUMAR N (6.1.97)	/	/	/	/	/
40	731615114100	OM ADHAVAN B	/	/	/	/	/
41	731615114101	PALANISAMY R	/	/	/	/	/
42	731615114105	PRINSHITH P	/	/	/	/	/
43	731615114106	PRITAM BHATTACHARYA G	/	/	/	/	/
44	731615114107	PUGAZHENDI S K	/	/	/	/	/
45	731615114108	PUVIYARASAN N	/	/	/	/	/

Dr..M. VENKATESAN, M.E., Ph.D.,
 PRINCIPAL,
 K S R INSTITUTE FOR
 ENGINEERING AND TECHNOLOGY,
 K.S.R. KALVI NAGAR,
 TIRUCHENGODE-637 215,

S.NO	REG.NO	NAME OF THE STUDENT	10.12.18	11.12.18	12.12.18	13.12.18	14.12.18
46	731615114109	RAGU S	/	/	/	/	/
47	731615114112	RAMESH M	/	/	/	/	/
48	731615114113	RAMKUMAR M	/	/	/	/	/
49	731615114304	BOOPATHI S	/	/	/	/	/
50	731615114116	SABARIRAJ D	/	/	/	/	/
51	731615114117	SAI HARISH V	/	/	/	/	/
52	731615114118	SAMUEL DURAI A	/	/	/	/	/
53	731615114120	SANTHOSH K	/	/	/	/	/
54	731615114126	SASIKUMAR S (02.03.1998)	/	/	/	/	/
55	731615114128	SATHISHKUMAR S	/	/	/	/	/
56	731615114129	SATHISH KUMAR T	/	/	/	/	/
57	731615114133	SHANKAR K	/	/	/	/	/
58	731615114134	SHEIKMOHAMED M	/	/	/	/	/
59	731615114140	SUBHASH S	/	/	/	/	/
60	731615114141	SUDHAKAR R M	/	/	/	/	/
61	731615114147	SYLESH P	/	/	/	/	/
62	731615114148	TAMILVANAN M	/	/	/	/	/
63	731615114149	THAGAPPILLAI G	/	/	/	/	/
64	731615114153	VASANTHAKUMAR B	/	/	/	/	/
65	731615114155	VENGAINAYAGAN K	/	/	/	/	/
66	731615114161	VIJAY M	/	/	/	/	/
67	731615114166	YOGESH K	/	/	/	/	/
68	731615114313	NAVEEN A	/	/	/	/	/
69	731615114314	NETHAJI M	/	/	/	/	/
Course Coordinator			/	/	/	/	/
HoD			/	/	/	/	/

 Dr. M. VENKATESAN, M.E., Ph.D.,
 PRINCIPAL,
 K S R INSTITUTE FOR
 ENGINEERING AND TECHNOLOGY,
 K.S.R. KALVI NAGAR,
 TIRUCHENGODE-637 215,
 NAMAKKAL Dt, TAMIL NADU.

K S R Institute for Engineering and Technology
Department of Mechanical Engineering
Value Added Course on CREO AUTOMATION AND PRODUCTION

Year: IV

Assessment

Academic Year:2018-19

S.NO	REG.NO	NAME OF THE STUDENT	Marks(50)
1	731615114001	ADHISHANKARAN D	40
2	731615114002	AJITH K S	38
3	731615114003	AJITH V	40
4	731615114008	ARAVINDH P	37
5	731615114012	ASHWIN L	36
6	731615114013	BALACHANDARAN S	42
7	731615114016	BALAJI RAM G	40
8	731615114017	BALAKRISHNAN C	36
9	731615114018	BALAKUMAR A	40
10	731615114019	BENAZIR U	44
11	731615114020	BHARATH P	41
12	731615114023	BHUVANESHWARAN S	36
13	731615114025	CELLAKAMALALAKSHMI R	40
14	731615114030	DHANUSH R	41
15	731615114032	DHINESH S	35
16	731615114038	DINESHKUMAR T	38
17	731615114044	GIRIDHARAN B	39
18	731615114045	GNANA PRAKASH A S	38
19	731615114046	GOBINATH R	38
20	731615114055	JACKSON P V	41
21	731615114056	JAGADEESH S	37
22	731615114301	AJITH M	38
23	731615114302	ARUN AAKASH S	43
24	731615114060	KABIL L	39
25	731615114065	KAVINKUMAR R	38
26	731615114066	KAVIPRIYAN S	36
27	731615114073	MADHAN KUMAR M	36
28	731615114074	MADHUSUDHAN R	45
29	731615114075	MANIKANDABOOPATHI B	41
30	731615114076	MANIKANDAN G	45
31	731615114077	MANIKANDAN P	44
32	731615114078	MANIKANDAN S	41
33	731615114080	MANOJKUMAR P R	37
34	731615114084	MOHANPRABHU K	35
35	731615114086	NANDHAKUMAR M	36
36	731615114088	NANDHAKUMAR S (22/8/98)	38
37	731615114093	NAVEEN N	41
38	731615114094	NAVEENKUMAR B	37
39	731615114095	NAVEEN KUMAR N (6.1.97)	35
40	731615114100	OM ADHAVAN B	44
41	731615114101	PALANISAMY R	43
42	731615114105	PRINSHITH P	40
43	731615114106	PRITAM BHATTACHARYA G	33
44	731615114107	PUGAZHENDI S K	38
45	731615114108	PUVIYARASAN N	37
46	731615114109	RAGU S	41
47	731615114112	RAMESH M	37
48	731615114113	RAMKUMAR M	36
49	731615114304	BOOPATHI S	36

Dr. M. VENKATESAN, M.E., Ph.D
PRINCIPAL,
K S R INSTITUTE FOR
ENGINEERING AND TECHNOLOG
K.S.R. KALVI NAGAR,
TIRUCHENGODE-637 215,
NAMAKKAL Dt, TAMIL NADU.

S.NO	REG.NO	NAME OF THE STUDENT	Marks(50)
50	731615114116	SABARIRAJ D	42
51	731615114117	SAI HARISH V	38
52	731615114118	SAMUEL DURAI A	36
53	731615114120	SANTHOSH K	37
54	731615114126	SASIKUMAR S (02.03.1998)	39
55	731615114128	SATHISHKUMAR S	42
56	731615114129	SATHISH KUMAR T	38
57	731615114133	SHANKAR K	36
58	731615114134	SHEIKMOHAMED M	45
59	731615114140	SUBHASH S	44
60	731615114141	SUDHAKAR R M	41
61	731615114147	SYLESH P	36
62	731615114148	TAMILVANAN M	38
63	731615114149	THAGAPPILLAI G	36
64	731615114153	VASANTHAKUMAR B	38
65	731615114155	VENGAINAYAGAN K	39
66	731615114161	VIJAY M	38
67	731615114166	YOGESH K	36
68	731615114313	NAVEEN A	38
69	731615114314	NETHAJI M	41
Course Coordinator			
HoD			

 Dr. M. VENKATESAN, M.E., Ph.D.,
 PRINCIPAL,
 K S R INSTITUTE FOR
 ENGINEERING AND TECHNOLOGY,
 K.S.R. KALVI NAGAR,
 TIRUCHENGODE-637 215,
 NAMAKKAL Dt, TAMIL NADU.

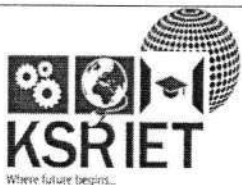

K S R INSTITUTE FOR ENGINEERING AND TECHNOLOGY
Tiruchengode, Namakkal – 637215

Department of Mechanical Engineering

Value Added Course - Creo for Automation and production

Date: 14/12/18

Tick the Appropriate Columns:

Parameter	Excellent	Very Good	Good	Satisfactory
Content Delivered	/			
Registration		/		
Program Management	/			
Hospitality	/			
About Campus	/			

Participant Name: *L. Kabil*

Suggestions for Improvement:

L. Kabil
Signature of the Participant

[Signature]
Dr. M. VENKATESAN, M.E., Ph.D.,
PRINCIPAL,
K S R INSTITUTE FOR
ENGINEERING AND TECHNOLOGY,
K.S.R. KALVI NAGAR,
TIRUCHENGODE-637 215,
NAMAKKAL DL, TAMIL NADU.



K S R INSTITUTE FOR ENGINEERING AND TECHNOLOGY
Tiruchengode, Namakkal – 637215

Department of Mechanical Engineering

Value Added Course - Creo for Automation and production

Date: 14/12/18

Tick the Appropriate Columns:

Parameter	Excellent	Very Good	Good	Satisfactory
Content Delivered	✓			
Registration		✓		
Program Management	✓			
Hospitality		✓		
About Campus	✓			

Participant Name: Benazir U

Suggestions for Improvement:

Signature of the Participant

Dr. M. VENKATESAN, M.E., Ph.D.,
PRINCIPAL,
K S R INSTITUTE FOR
ENGINEERING AND TECHNOLOGY,
K.S.R. KALVI NAGAR,
TIRUCHENGODE-637 215,
NAMAKKAL Dt, TAMIL NADU.

K S R INSTITUTE FOR ENGINEERING AND TECHNOLOGY

TIRUCHENGODE – 637 215

DEPARTMENT OF MECHANICAL ENGINEERING

VALUE ADDED / SHORT TERM COURSE – SUMMARY

Academic Year: 2018-19 (EVEN)

Name of the course	Five days Value Added / Short Term course on CREO FOR AUTOMATION AND PRODUCTION
Course Contents	➤ Enclosed
Course Outcomes	<ul style="list-style-type: none">➤ Student will have seamless data sharing ability; they can easily design entire process, from concept design work to manufacturing the final product.➤ Student can automatically do associative manufacturing and service deliverables generation.➤ Student can add manufacturing businesses transition into model-based enterprises.➤ Student will have enough skills to increase productivity, do better concept design, increase engineering & manufacturing capabilities, do better simulation and additive manufacturing.
Program Outcomes & Program Specific Outcomes	PO1,PO3,PO4,PO5,PO6,PO9,P10,PO12,PSO2
Course Convener	Dr.P.MURUGESAN, HoD/MECH
Course Coordinators	Mr.S.Ponnusamy AP/MECH
Resource Persons	Mr.A.M.Ramkumar Mr. S.Baskaran Ms.G.Anitha Mr. M.Sathish kumar
Duration & Dates	Five days (38 Hours) & 10/12/2018 to 14/12/2018
Participants & Strength	IV YEAR MECH KSRIET STUDENTS & 69

Coordinator



Dr. M. VENKATESAN, M.E., Ph.D.,
PRINCIPAL,
K S R INSTITUTE FOR
ENGINEERING AND TECHNOLOGY,
K.S.R. KALVI NAGAR,
TIRUCHENGODE-637 215,
NAMAKKAL DI, TAMIL NADU.

Convener

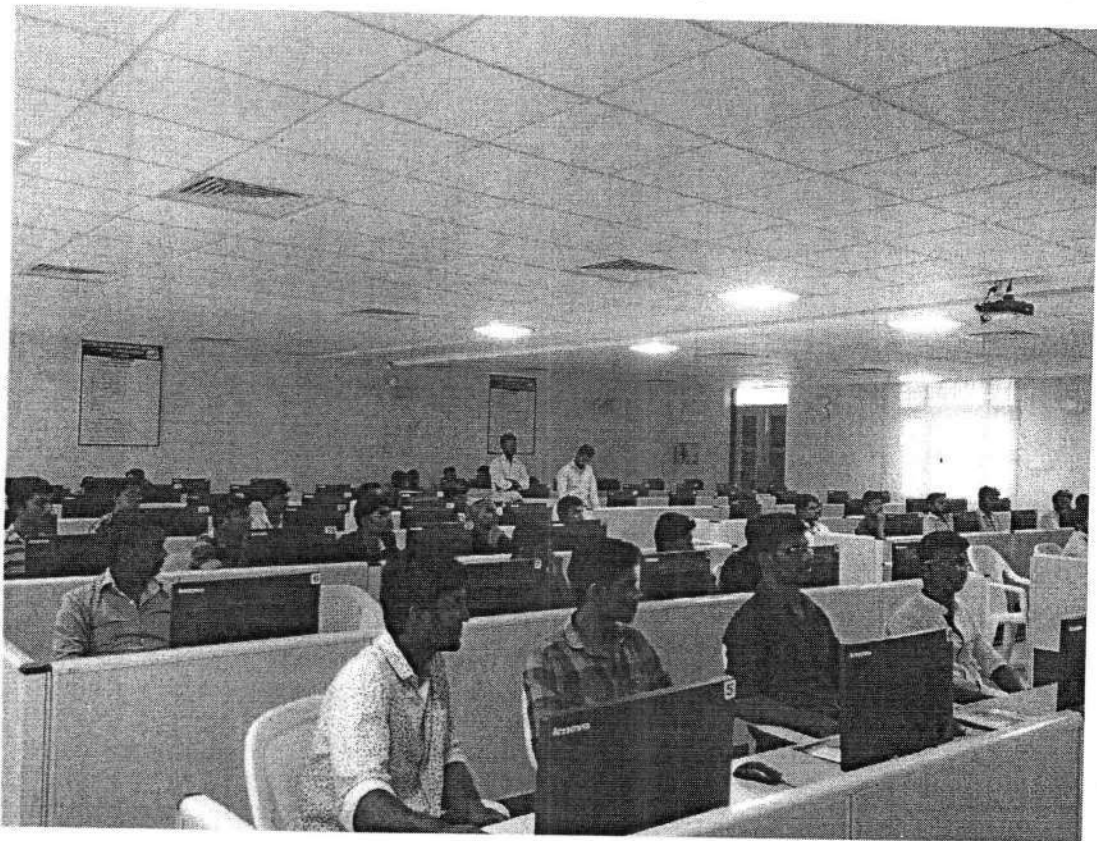
**KSR INSTITUTE FOR ENGINEERING AND TECHNOLOGY
DEPARTMENT OF MECHANICAL ENGINEERING
CENTRE FOR VALUE ADDED EDUCATION (CENVAE)**

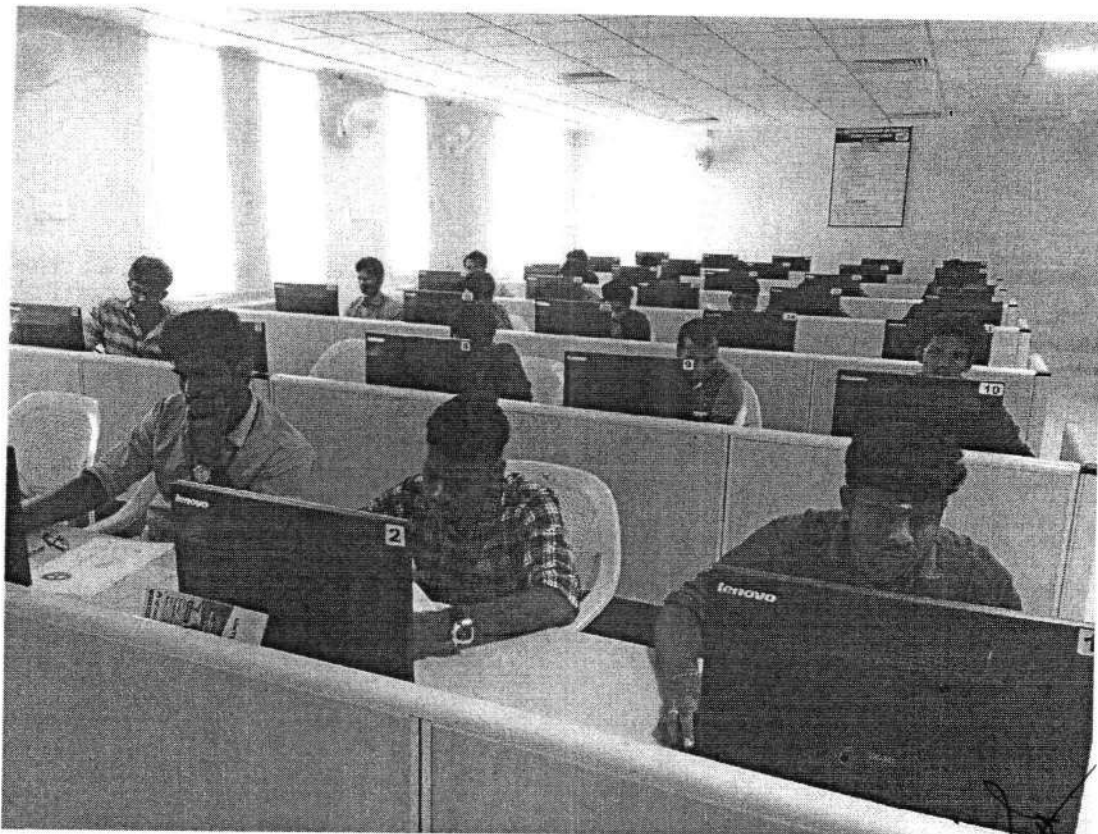

VALUE ADDED COUSE FOR CERO AUTOMATION AND PRODUCTION



**Dr. M. VENKAVESAN, M.E., Ph.D.,
PRINCIPAL,
K S R INSTITUTE FOR
ENGINEERING AND TECHNOLOGY,
K.S.R. KALVI NAGAR,
TIRUCHENGODE-637 215,
NAMAKKAL Dt, TAMIL NADU.**



K S R INSTITUTE FOR ENGINEERING & TECHNOLOGY

(APPROVED BY AICTE, NEW DELHI AND AFFILIATED TO ANNA UNIVERSITY, CHENNAI)



DEPARTMENT OF MECHANICAL ENGINEERING CENTRE FOR VALUE ADDED EDUCATION (CEVVAE)

VALUE ADDED COURSE CREO - AUTOMATION AND PRODUCTION

CERTIFICATE OF PARTICIPATION

This is to certify that Mr. /Ms. J. KABIL of IV YEAR
Department of Mechanical Engineering, K S R INSTITUTE FOR ENGINEERING AND
TECHNOLOGY has attended a Five days value added course on "Creo
Automation and production" organized by the Department of Mechanical
Engineering, KSR IET from 10.12.18 to 14.12.18.

COORDINATOR

HOD

Dr. M. VEERAYAN M.B.B.E.

PRINCIPAL

ENGINEERING AND TECHNOLOGY,
K.S.R. KALVINAGAR,
TIRUCHENGODE-637 215,
NAMAKKAL DI, TAMIL NADU.