



K S R Institute for Engineering and Technology

Tiruchengode, Namakkal (Dt), Tamil Nadu

(Approved by AICTE New Delhi & Affiliated to Anna University Chennai)

BE (CSE, EEE, ECE, Mech) & B.Tech (IT) Programmes are Accredited by NBA

5.1.3 Capacity building and skills enhancement initiatives taken by the institution

ACADEMIC YEAR - 2019-2020

| S.No | Academic year | Page No |
|-------------|--|----------------|
| 1 | Soft Skills | 02 – 183 |
| 2 | Language and Communication Skills | 184 – 200 |
| 3 | Life Skills (Yoga, physical fitness, health and hygiene) | 201 – 227 |
| 4 | ICT/Computing skills | 228 - 347 |

1. SOFT SKILLS

K S R INSTITUTE FOR ENGINEERING AND TECHNOLOGY

SOFT SKILLS CONSOLIDATE LIST

Academic Year:2019-2020

| S.NO. | Name of the capability enhancement program | Date of implementation (DD-MM-YYYY) | Number of students enrolled | Name of the agencies/consultants involved with contact details (if any) |
|-------|--|-------------------------------------|-----------------------------|---|
| 1 | Competitive Exams Training | 03.06.2019 | 29 | Ramax Academy, ramaxacademyerode@gmail.com |
| 2 | External Aptitude Training | 10.06.2019 | 151 | Six Phrase Training Agency, Sixphrase@gmail.com |
| 3 | Aptitude Training | 01.07.2019 | 85 | Talent 2 success Learning, coo@t2slearning.com |
| 4 | Aptitude Training | 01.07.2019 | 185 | Face Training, faceprepcampus@focusacademy.in |
| 5 | Aptitude Training | 22.07.2019 | 65 | Talent 2 success Learning, coo@t2slearning.com |
| 6 | Soft Skill Orientation Programme | 23.12.2019 | 161 | KSREI - CPC, placement@ksrei.org |
| 7 | Worshop on Imparting the skills of effective Communication and Professional Etiquettes | 08.01.2020 | 56 | KSREI - CPC, placement@ksrei.org |

PRINCIPAL,
K. S. R. INSTITUTE FOR
ENGINEERING AND TECHNOLOGY,
K. S. R. KALVI NAGAR,
TIRUCHENGODE-637 215,
NAMAKKAL Dt, TAMIL NADU.

| | | | | |
|----|---|------------|----|-------------------------------------|
| 8 | Company Specific Soft Skills Training Programme | 17.01.2020 | 27 | KSREI - CPC, placement@ksrei.org |
| 9 | Soft Skill Training Programme | 21.01.2020 | 15 | KSREI - CPC, placement@ksrei.org |
| 10 | Skills for Work | 22.01.2020 | 47 | Cambridge Assessment Team |
| 11 | Personality Development & Soft Skills Training | 05.02.2020 | 50 | KSREI - CPC, placement@ksrei.org |

PRINCIPAL

... AND TECHNOLOGY,
K. S. R. KALVI NAGAR,
TIRUCHENGODE - 637 215,
NAMAKKAL DI, TAMIL NADU.



Ref: KSRIET/T&P/CIR/2019-20

Date: 30.05.2019

This is to inform that all the HoD's, Class Advisor's and Training & Placement coordinators that the hall arrangements for IV year (2016 -2020 Batch) Internal and External Training for the academic year 2019 - 2020 (Odd Sem) are given below.

| S.N O | Date(s) | Topics | Strength | Venue |
|----------|--------------------------------|--|--|---|
| 1 | 03.06.2019 to 08.06.2019 | Competitive Exam Training by Ramax | ECE - 8, EEE - 16 & MECH - 5 | Mechanical Block - 102 |
| 2 | 03.06.2019 to 07.06.2019 | C Training for all Placement Registered Students (Except FSD & JAVA Students of Circuit Branches) | CSE - 4 , ECE-5 , EEE - 19, IT - 5 | Main Block CSE Lab (Left Side - White System) |
| 3 | 10.06.2019 to 14.06.2019 | C Training for all Placement Registered Students of Mech Dept. | Batch 1 - 33 Batch 2 - 46 | * Batch 1 - CAD Lab Batch 2 - Virtusa Lab * - Venue May be Changed |

Aptitude Training for Circuit Branch - All Placements Registered Students

| S.NO | Date(s) | Batch | Venue | | |
|------|---|--|------------------------------|--|---|
| | | | Theory Session Hall No | Lab Session | Test Session (04:30 to 06:30 P.M) |
| 1 | 10.06.2019 to 22.06.2019 (12 Days) | Batch 1 (FSD - 61) | M 101 | MECH Block CSE Lab | MECH Block CSE Lab |
| | | Batch 2 (Java(40) + EEE(8) - 48) | M 102 | Virtusa Lab / Main Block CSE Lab | MECH Block Virtusa Lab |
| | | Batch 3 (Except Java & FSD - 50) | M 103 | Virtusa Lab / Main Block CSE Lab | MECH Block CAD Lab |

[Signature]
T&P OFFICER
30/5/19

[Signature]
T&P COORDINATOR
30/5/19

[Signature]
PRINCIPAL
30/5/19

Copy to: 1. All HoDs

2. Notice Board

KSRIET
K. S. R. INSTITUTE FOR
ENGINEERING AND TECHNOLOGY,
K. S. R. HALL NAGAR,
TIRUCHENGODE - 637 215,
NAMAKKAL DI, TAMIL NADU.

K S R INSTITUTE FOR ENGINEERING AND TECHNOLOGY, TIRUCHENGODE - 637215

TRAINING AND PLACEMENT CELL

Center for Competitive Exams Association with Ramax Academy

Academic Year:2019 - 2020

Sem:ODD

| S.No | Reg No | Name | Branch | 03.06.19 | | 04.06.19 | | 06.06.19 | | 07.06.19 | | 08.06.19 | |
|-------------------|--------------|------------------|---------|----------|----|----------|----|----------|----|----------|----|----------|----|
| | | | | FN | AN | FN | AN | FN | AN | FN | AN | FN | AN |
| 1 | 731616114071 | RUTHRANNAN B | MECH B | A | A | A | A | A | A | A | A | A | A |
| 2 | 731616114074 | SAKTHIVEL R | MECH B | A | A | A | A | A | A | A | A | A | A |
| 3 | 731616114075 | SANJAY KUMAR S | MECH B | A | A | A | A | A | A | A | A | A | A |
| 4 | 731616114078 | SANTHOSH KUMAR V | MECH B | A | A | A | A | A | A | A | A | A | A |
| 5 | 731616114082 | SHAKTHI R M | MECH B | A | A | A | A | A | A | A | A | A | A |
| 6 | 731616105004 | ANBALAGAN.M | EEE | / | / | / | / | / | / | / | / | / | / |
| 7 | 731616105010 | DIVYADEVI.V | EEE | / | / | / | / | / | / | / | / | / | / |
| 8 | 731616105017 | KANIMOZHI.V | EEE | / | / | / | / | / | / | / | / | / | / |
| 9 | 731616105020 | KAVIYA.M | EEE | / | / | / | / | / | / | / | / | / | / |
| 10 | 731616105029 | MUGESH.M | EEE | / | / | / | / | / | / | / | / | / | / |
| 11 | 731616105030 | MYTHILI.N | EEE | / | / | / | / | / | / | / | / | / | / |
| 12 | 731616105032 | NANDHINI.M | EEE | / | / | / | / | / | / | / | / | / | / |
| 13 | 731616105036 | PRAKASH.S.P | EEE | / | / | / | / | / | / | / | / | / | / |
| 14 | 731616105038 | PRAVIN.R | EEE | / | / | / | / | / | / | / | / | / | / |
| 15 | 731616105039 | PREETHA.E | EEE | / | / | / | / | / | / | / | / | / | / |
| 16 | 731616105041 | SARANYA.P | EEE | / | / | / | / | / | / | / | / | / | / |
| 17 | 731616105045 | SUJITHA.E | EEE | / | / | / | / | / | / | / | / | / | / |
| 18 | 731616105047 | VIVEK.V | EEE | / | / | / | / | / | / | / | / | / | / |
| 19 | 731616105002 | AJITHA P | EEE | / | / | / | / | / | / | / | / | / | / |
| 20 | 731616105046 | SUVETHA T | EEE | / | / | / | / | / | / | / | / | / | / |
| 21 | 731616105003 | AKILAN G | EEE | A | A | A | A | A | A | A | A | A | A |
| 22 | 731616106046 | NANDHAKUMARAN R | ECE - B | / | / | / | / | / | / | / | / | / | / |
| 23 | 731616106049 | NIVETHA S | ECE - B | / | / | / | / | / | / | / | / | / | / |
| 24 | 731616106054 | PRIYADHARSHINI S | ECE | / | / | / | / | / | / | / | / | / | / |
| 25 | 731616106066 | SHARVESH RAM K R | ECE | / | / | / | / | / | / | / | / | / | / |
| 26 | 731616106067 | SHOWMIYA M | ECE | / | / | / | / | / | / | / | / | / | / |
| 27 | 731616106069 | SRIMATHI G | ECE - B | / | / | / | / | / | / | / | / | / | / |
| 28 | 731616106075 | SYED SALMAN N | ECE - B | / | / | / | / | / | / | / | / | / | / |
| 29 | 731616106080 | THARANYA P | ECE | / | / | / | / | / | / | / | / | / | / |
| Present | | | | 23 | 23 | 23 | 23 | 23 | 23 | 23 | 23 | 23 | 23 |
| Absent | | | | 6 | 6 | 6 | 6 | 6 | 6 | 6 | 6 | 6 | 6 |
| Permission | | | | 0 | 0 | 0 | 0 | 0 | 0 | 0 | 0 | 0 | 0 |

PRINCIPAL,
K. S. R. INSTITUTE FOR
ENGINEERING AND TECHNOLOGY,
K. S. R. KALVI NAGAR,
TIRUCHENGODE - 637 215,
NARAIKAL D2, TAMIL NADU.

**K S R INSTITUTE FOR ENGINEERING AND TECHNOLOGY
TIRUCHENGODE - 637 215**

TRAINING PROGRAMME FEEDBACK FORM



Name of the Student: Nandhini - M Branch: PEE

Year / Sem: IV / VII

1. Name of the Training: Competitive Exam Training

2. Name of the Trainer: Ranax Academy

3. Students rating of Trainers :

| S. No. | Date | Subject | Rating (√) | | | |
|--------|--------|---------------------------|------------|-----------|------|---------|
| | | | Excellent | Very good | Good | Average |
| 1 | 8-6-19 | Competitive Exam Training | ✓ | | | |

4. Two positive points about the programme:

* Expectations fulfilled.

5. Suggestions for improvement:

* Need one more session

Date: 8/6/19

Nandhini - M
Signature

**K S R INSTITUTE FOR ENGINEERING AND TECHNOLOGY
TIRUCHENGODE - 637 215**

TRAINING PROGRAMME FEEDBACK FORM



Name of the Student: SHOWMIYA M Branch: ECE

Year / Sem: IV / VII

1. Name of the Training: COMPETITIVE EXAM TRAINING

2. Name of the Trainer: RANAX ACADEMY

3. Students rating of Trainers :

| S. No. | Date | Subject | Rating (√) | | | |
|--------|------------|---------------------------|------------|-----------|------|---------|
| | | | Excellent | Very good | Good | Average |
| 1 | 08.06.2019 | COMPETITIVE EXAM TRAINING | ✓ | | | |

4. Two positive points about the programme:

* The session was very interesting & useful.

5. Suggestions for improvement:

* Need more classes

Date: 08.06.19

M. Shange
Signature



External Aptitude Training

Ref: KSRIET/T&P/CIR/2019-20

Date: 07.06.2019

This is to inform that all the HoD's, Class Advisor and Training and Placement coordinators that we have planned aptitude training for Final Year students topics on "External Aptitude Training" (2016 - 2020 batch) on from 10.06.2019-22.06.2019 at ECE Seminar Hall by **Six Phrase Training Agency** for the academic year 2019 - 2020 (Odd Sem). All the Registered students should attend the training without fail.

| S.NO | Date & Time | Eligible Students Count |
|------|-------------------------------|--|
| 1 | 10.06.2019 & 22.06.2019 | CSE- 29, ECE - 54,EEE- 42 & IT - 26 Total - 151 |

[Signature]
T&P OFFICER

[Signature]
T&P COORDINATOR

[Signature]
PRINCIPAL

Copy to:

1. All HoDs
2. Notice Board

[Green Stamp]
PRINCIPAL,
K. S. R. INSTITUTE FOR
ENGINEERING AND TECHNOLOGY,
K. S. F. MAIN ROAD,
TIRUCHENGODE - 637 215,
NAMAKKAL DISTRICT, TAMIL NADU.

Training and Placement Cell

Batch 1 - External Aptitude Training Attendance (Odd Semester)

| BATCH : 2016 - 2020 | | | | Incharge: CSE / IT | | | | Academic Year: 2019 - 2020 | | | | | | | |
|----------------------------|--------------|--------------------|--------|--------------------|----|------------|----|----------------------------|----|------------|----|------------|----|------------|----|
| Date of Training Programme | | | | 10.06.2019 | | 11.06.2019 | | 12.06.2019 | | 13.06.2019 | | 14.06.2019 | | 15.06.2019 | |
| S. No | Reg No | Name | Branch | FN | AN | FN | AN | FN | AN | FN | AN | FN | AN | FN | AN |
| 1 | 731616104003 | ANISHA.N | CSE | / | / | / | / | / | / | P | P | / | / | / | / |
| 2 | 731616104004 | ARUN.R | CSE | / | / | / | / | / | / | / | / | / | / | / | / |
| 3 | 731616104013 | ILAKIYA.S | CSE | / | / | / | / | / | / | / | / | / | / | / | / |
| 4 | 731616104019 | LAXMANCIBI.S | CSE | / | / | / | / | / | / | / | / | / | / | / | / |
| 5 | 731616104020 | MANIKANDAN.K | CSE | / | / | / | / | / | / | / | / | / | / | / | / |
| 6 | 731616104022 | MEGASURIYAN.E | CSE | / | / | / | / | / | / | / | / | P | P | / | / |
| 7 | 731616104023 | MOHAMMEDSAMIR.A | CSE | / | / | / | / | / | / | / | / | A | A | / | / |
| 8 | 731616104027 | PRAVEEN KUMAR.M | CSE | / | / | / | / | / | / | / | / | / | / | / | / |
| 9 | 731616104031 | PUGAZHIVELAN.P | CSE | / | / | A | A | / | / | / | / | / | / | / | / |
| 10 | 731616104033 | RAJARAJAN.A | CSE | / | / | / | / | / | / | / | / | / | / | / | / |
| 11 | 731616104034 | SELVAMALINI.J | CSE | / | / | P | P | / | / | / | / | / | / | / | / |
| | 731616104040 | SWETHA.B | CSE | / | / | / | / | / | / | A | A | / | / | / | / |
| 13 | 731616104041 | SWETHA.C | CSE | / | / | / | / | / | / | / | / | / | / | / | / |
| 14 | 731616104042 | VASU MITHA.R.S | CSE | / | / | / | / | / | / | / | / | / | / | / | / |
| 15 | 731616104043 | VELU PRABHA.S | CSE | / | / | / | / | / | / | / | / | / | / | / | / |
| 16 | 731616104046 | VIGNESH.G | CSE | / | / | / | / | / | / | / | / | / | / | / | / |
| 17 | 731616104048 | YUVAPRIYANKA.V | CSE | / | / | / | / | / | / | / | / | / | / | / | / |
| 18 | 731616104701 | S.KOMATHI | CSE | / | / | / | / | / | / | / | / | / | / | / | / |
| 19 | 731616106001 | ABDULKADHAR S | ECE | / | / | / | / | / | / | / | / | / | / | / | / |
| 20 | 731616106005 | AKSHAYA N M | ECE | / | / | / | / | / | / | / | / | / | / | / | / |
| 21 | 731616106007 | ANANTHA KRISHNAN P | ECE | / | / | / | / | / | / | / | / | / | / | / | / |
| 22 | 731616106009 | ASWIN S | ECE | / | / | / | / | / | / | / | / | / | / | / | / |
| 23 | 731616106010 | BALAJI R | ECE | / | / | / | / | / | / | / | / | / | / | / | / |
| 24 | 731616106012 | BHAVYASHREE S | ECE | / | / | / | / | / | / | / | / | / | / | / | / |
| | 731616106023 | GOKULAKRISHNAN A | ECE | / | / | / | / | / | / | / | / | / | / | / | / |
| 26 | 731616106026 | ILAKIYA S | ECE | / | / | / | / | / | / | A | A | / | / | / | / |
| 27 | 731616106027 | INDIRAKUMAR M | ECE | / | / | / | / | / | / | / | / | / | / | / | / |
| 28 | 731616106038 | MALATHI A S | ECE | / | / | / | / | / | / | P | P | / | / | / | / |
| 29 | 731616106039 | MARIMUTHU M | ECE | / | / | / | / | / | / | / | / | / | / | / | / |
| 30 | 731616106047 | NARESHKUMAR S | ECE | / | / | / | / | / | / | / | / | / | / | / | / |
| 31 | 731616106048 | NAVEEN K | ECE | / | / | / | / | / | / | / | / | P | P | / | / |
| 32 | 731616106049 | NIVETHA S | ECE | / | / | / | / | / | / | / | / | / | / | / | / |
| 33 | 731616106055 | PRIYADHARSHNI P | ECE | / | / | / | / | / | / | / | / | / | / | / | / |
| 34 | 731616106060 | ROSHINI T | ECE | / | / | / | / | / | / | / | / | / | / | / | / |
| 35 | 731616106065 | SELLAKRISHNARAJA S | ECE | / | / | / | / | / | / | / | / | / | / | / | / |
| 36 | 731616106072 | SUMATHI R | ECE | / | / | / | / | / | / | / | / | / | / | / | / |
| 37 | 731616106076 | TAMILARASI S | ECE | / | / | / | / | / | / | / | / | / | / | / | / |

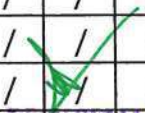
PRINCIPAL
ENGINEERING AND TECHNOLOGY,
K. S. P. KALYANAGAR,
TIRUCHENGODUR - 637 215,
NAMAKKAL DISTRICT, TAMIL NADU.

| | | | | | | | | | | | | | | | | |
|-------------------|--------------|---------------------|-----|---|----|----|----|----|----|----|----|----|----|----|----|----|
| 39 | 731616106084 | YOGESH S | ECE | / | / | / | / | / | / | / | / | / | / | / | / | |
| 40 | 731616105007 | BHARATHI KANNAN M R | EEE | / | / | / | / | / | / | / | / | / | / | / | / | |
| 41 | 731616105016 | KAMALI SOUNDARYA B | EEE | P | P | / | / | P | P | P | P | P | P | P | P | |
| 42 | 731616105018 | KARTHIKA DEVI S | EEE | / | / | / | / | / | / | / | / | / | / | / | / | |
| 43 | 731616105026 | MERLIN INFANTA S | EEE | / | / | / | / | / | / | / | / | / | / | / | / | |
| 44 | 731616105034 | NITHIYASRI R | EEE | / | / | / | / | / | / | / | / | / | / | / | / | |
| 45 | 731616105043 | SHANKAR NARAYAN.M | EEE | / | / | / | / | / | / | / | / | / | / | / | / | |
| 46 | 731616105044 | SIBIN.S | EEE | / | / | / | / | / | / | / | / | / | / | / | / | |
| 47 | 731616205009 | GOWRI D | IT | / | / | / | / | / | / | / | / | / | / | / | / | |
| 48 | 731616205011 | HAKKEM M | IT | / | / | / | / | / | / | / | / | / | / | / | / | |
| 49 | 731616205014 | JANANI M | IT | / | / | / | / | / | / | / | / | / | / | / | / | |
| 50 | 731616205015 | JANANI R | IT | / | / | / | / | / | / | / | / | / | / | / | / | |
| 51 | 731616205016 | JANANI T | IT | / | / | / | / | / | / | / | P | P | / | / | / | |
| 52 | 731616205023 | MOHANRAJ S | IT | / | / | / | / | / | / | / | / | / | / | / | / | |
| 53 | 731616205025 | NESHAK KUMAR S | IT | / | / | / | / | / | / | / | / | / | / | / | / | |
| 54 | 731616205026 | OVIYA A | IT | / | / | / | / | / | / | / | / | / | / | / | / | |
| 55 | 731616205028 | PRIYADARSHNI G | IT | / | / | / | / | / | / | / | P | P | / | / | / | |
| 56 | 731616205029 | SAKTHIRAVIKUMAR M | IT | / | / | / | / | / | / | A | A | P | P | / | / | |
| 57 | 731616205036 | SUDARSAN S | IT | / | / | / | / | / | / | / | / | / | / | / | / | |
| 58 | 731616205037 | SHUGITHA VS | IT | / | / | / | / | / | / | / | / | / | / | / | / | |
| 59 | 731616205038 | SUMITHA J | IT | / | / | / | / | / | / | / | P | P | / | / | / | |
| 60 | 731616205040 | TAMILARASAN G | IT | / | / | / | / | / | / | / | / | / | / | / | / | |
| PRESENT | | | | | 59 | 59 | 58 | 58 | 59 | 59 | 54 | 54 | 52 | 52 | 59 | 59 |
| ABSENT | | | | | 0 | 0 | 1 | 1 | 0 | 0 | 3 | 3 | 1 | 1 | 0 | 0 |
| PERMISSION | | | | | 1 | 1 | 1 | 1 | 1 | 1 | 3 | 3 | 7 | 7 | 0 | 0 |

PRINCIPAL,
K. S. R. INSTITUTE FOR
ENGINEERING AND TECH
K. S. R. KALVI SADA
TIRUCHENGOORE -66.
NAMAKKAL DISTRICT, TAMIL NADU.

Training and Placement Cell

Batch 1 - External Aptitude Training Attendance (Odd Semester)

| BATCH : 2016 - 2020 | | | | Incharge: CSE / IT | | | | Academic Year: 2019 - 2020 | | | | | | | |
|----------------------------|--------------|--------------------|--------|--------------------|----|------------|----|----------------------------|----|------------|----|------------|----|------------|----|
| Date of Training Programme | | | | 17.06.2019 | | 18.06.2019 | | 19.06.2019 | | 20.06.2019 | | 21.06.2019 | | 22.06.2019 | |
| S. No | Reg No | Name | Branch | FN | AN | FN | AN | FN | AN | FN | AN | FN | AN | FN | AN |
| 1 | 731616104003 | ANISHA.N | CSE | P | P | / | / | / | / | / | / | / | / | / | / |
| 2 | 731616104004 | ARUN.R | CSE | / | / | / | / | / | / | / | / | / | / | / | / |
| 3 | 731616104013 | ILAKIYA.S | CSE | / | / | / | / | / | / | P | P | / | / | / | / |
| 4 | 731616104019 | LAXMANCIBI.S | CSE | / | / | / | / | / | / | / | / | P | P | A | A |
| 5 | 731616104020 | MANIKANDAN.K | CSE | / | / | / | / | / | / | / | / | / | / | / | / |
| 6 | 731616104022 | MEGASURIYAN.E | CSE | / | / | / | / | / | / | P | P | / | / | / | / |
| 7 | 731616104023 | MOHAMMEDSAMIR.A | CSE | / | / | / | / | / | / | / | / | / | / | / | / |
| 8 | 731616104027 | PRAVEEN KUMAR.M | CSE | / | / | / | / | / | / | / | / | / | / | / | / |
| 9 | 731616104031 | PUGAZHIVELAN.P | CSE | / | / | / | / | / | / | / | / | / | / | / | / |
| 10 | 731616104033 | RAJARAJAN.A | CSE | / | / | / | / | / | / | / | / | / | / | / | / |
| 11 | 731616104034 | SELVAMALINI.J | CSE | / | / | / | / | / | / | / | / | / | / | / | / |
| 12 | 731616104040 | SWETHA.B | CSE | / | / | / | / | / | / | / | / | / | / | / | / |
| 13 | 731616104041 | SWETHA.C | CSE | / | / | / | / | / | / | / | / | / | / | / | / |
| 14 | 731616104042 | VASU MITHA.R.S | CSE | / | / | / | / | / | / | / | / | / | / | / | / |
| 15 | 731616104043 | VELU PRABHA.S | CSE | / | / | / | / | / | / | / | / | / | / | / | / |
| 16 | 731616104046 | VIGNESH.G | CSE | / | / | / | / | / | / | / | / | / | / | P | P |
| 17 | 731616104048 | YUVAPRIYANKA.V | CSE | / | / | / | / | / | / | / | / | / | / | / | / |
| 18 | 731616104701 | S.KOMATHI | CSE | / | / | / | / | / | / | / | / | / | / | / | / |
| 19 | 731616106001 | ABDULKADHAR S | ECE | / | / | / | / | / | / | / | / | / | / | / | / |
| 20 | 731616106005 | AKSHAYA N M | ECE | / | / | / | / | / | / | / | / | / | / | / | / |
| 21 | 731616106007 | ANANTHA KRISHNAN P | ECE | / | / | / | / | / | / | / | / | / | / | / | / |
| 22 | 731616106009 | ASWIN S | ECE | / | / | / | / | / | / | / | / | / | / | / | / |
| 23 | 731616106010 | BALAJI R | ECE | / | / | / | / | / | / | / | / | / | / | / | / |
| 24 | 731616106012 | BHAVYASHREE S | ECE | / | / | / | / | / | / | / | / | / | / | / | / |
| 25 | 731616106023 | GOKULAKRISHNAN A | ECE | / | / | / | / | / | / | / | / | / | / | / | / |
| 26 | 731616106026 | ILAKIYA S | ECE | / | / | / | / | / | / | / | / | / | / | / | / |
| 27 | 731616106027 | INDIRAKUMAR M | ECE | / | / | / | / | / | / | / | / | / | / | / | / |
| 28 | 731616106038 | MALATHI A S | ECE | / | / | / | / | / | / | / | / | / | / | / | / |
| 29 | 731616106039 | MARIMUTHU M | ECE | / | / | / | / | / | / | / | / | / | / | / | / |
| 30 | 731616106047 | NARESHKUMAR S | ECE | / | / | / | / | / | / | / | / | / | / | / | / |
| 31 | 731616106048 | NAVEEN K | ECE | / | / | / | / | / | / | / | / | / | / | / | / |
| 32 | 731616106049 | NIVETHA S | ECE | / | / | / | / | / | / | / | / | / | / | / | / |
| 33 | 731616106055 | PRIYADHARSHNI P | ECE | / | / | / | / | / | / | / | / | / | / | / | / |
| 34 | 731616106060 | ROSHINI T | ECE | / | / | / | / | / | / | / | / | / | / | / | / |
| 35 | 731616106065 | SELLAKRISHNARAJA S | ECE | / | / | / | / | / | / | / | / | / | / | / | / |
| 36 | 731616106072 | SUMATHI R | ECE | / | / | / | / | / | / | / | / | / | / | / | / |
| 37 | 731616106076 | TAMILARASI S | ECE | / | / | / | / | / | / | / | / | / | / | / | / |

K. S. R. PRINCIPAL,
K. S. R. INSTITUTION FOR
ENGINEERING AND TECHNOLOGY,
TRICHY, TAMIL NADU, INDIA.
621 015

| | | | | | | | | | | | | | | | | |
|-------------------|--------------|---------------------|-----|---|----|----|----|----|----|----|----|----|----|----|----|----|
| 39 | 731616106084 | YOGESH S | ECE | / | / | / | / | / | / | / | / | / | / | / | / | |
| 40 | 731616105007 | BHARATHI KANNAN M R | EEE | / | / | / | / | / | / | / | / | / | / | / | / | |
| 41 | 731616105016 | KAMALI SOUNDARYA B | EEE | P | P | / | / | / | / | / | / | P | P | / | / | |
| 42 | 731616105018 | KARTHIKA DEVI S | EEE | / | / | / | / | / | / | / | / | / | / | / | / | |
| 43 | 731616105026 | MERLIN INFANTA S | EEE | / | / | / | / | / | / | / | / | / | / | / | / | |
| 44 | 731616105034 | NITHIYASRI R | EEE | / | / | / | / | / | / | / | / | / | / | / | / | |
| 45 | 731616105043 | SHANKAR NARAYAN.M | EEE | / | / | / | / | / | / | / | / | / | / | / | / | |
| 46 | 731616105044 | SIBIN.S | EEE | / | / | / | / | / | / | / | / | / | / | / | / | |
| 47 | 731616205009 | GOWRI D | IT | / | / | / | / | / | / | / | / | / | / | / | / | |
| 48 | 731616205011 | HAKKEM M | IT | / | / | / | / | / | / | / | / | / | / | / | / | |
| 49 | 731616205014 | JANANI M | IT | / | / | / | / | / | / | / | / | / | / | / | / | |
| 50 | 731616205015 | JANANI R | IT | / | / | / | / | / | / | / | / | / | / | / | / | |
| 51 | 731616205016 | JANANI T | IT | / | / | / | / | / | / | / | / | / | / | / | / | |
| 52 | 731616205023 | MOHANRAJ S | IT | / | / | / | / | / | / | / | / | / | / | / | / | |
| 53 | 731616205025 | NESHAK KUMAR S | IT | / | / | / | / | / | / | / | / | / | / | / | / | |
| 54 | 731616205026 | OVIYA A | IT | / | / | / | / | / | / | / | / | / | / | / | / | |
| 55 | 731616205028 | PRIYADARSHNI G | IT | / | / | / | / | / | / | / | / | / | / | / | / | |
| 56 | 731616205029 | SAKTHIRAVIKUMAR M | IT | / | / | / | / | / | / | / | / | / | / | / | / | |
| 57 | 731616205036 | SUDARSAN S | IT | / | / | / | / | / | / | / | / | / | / | / | / | |
| 58 | 731616205037 | SHUGITHA VS | IT | / | / | / | / | / | / | / | / | / | / | P | P | |
| 59 | 731616205038 | SUMITHA J | IT | / | / | / | / | A | A | / | / | / | / | / | / | |
| 60 | 731616205040 | TAMILARASAN G | IT | / | / | / | / | / | / | / | / | / | / | / | / | |
| PRESENT | | | | | 58 | 58 | 60 | 60 | 58 | 58 | 58 | 58 | 58 | 58 | 57 | 57 |
| ABSENT | | | | | 0 | 0 | 0 | 0 | 1 | 1 | 0 | 0 | 0 | 0 | 1 | 1 |
| PERMISSION | | | | | 2 | 2 | 0 | 0 | 1 | 1 | 2 | 2 | 2 | 2 | 2 | 2 |

PRINCIPAL,
K. S. R. INSTITUTE FOR
ENGINEERING AND TECHNOLOGY,
K. S. R. KALU NAGAR,
CHENGOODE - 637 215,
BARAKKAL DI, TAMIL NADU.

Training and Placement Cell

Batch 2 - External Aptitude Training Attendance (Odd Semester)

| BATCH : 2016 - 2020 | | | | Incharge: ECE | | | | Academic Year: 2019 - 2020 | | | | | | | |
|----------------------------|--------------|-------------------|--------|---------------|----|------------|----|----------------------------|----|------------|----|------------|----|------------|----|
| Date of Training Programme | | | | 10.06.2019 | | 11.06.2019 | | 12.06.2019 | | 13.06.2019 | | 14.06.2019 | | 15.06.2019 | |
| S. No | Reg No | Name | Branch | FN | AN | FN | AN | FN | AN | FN | AN | FN | AN | FN | AN |
| 1 | 731616104005 | BARATH.K | CSE | / | / | / | / | / | / | / | / | / | / | / | / |
| 2 | 731616104011 | GOWTHAMAKUMARAN.P | CSE | P | P | / | / | A | A | / | / | A | A | / | / |
| 3 | 731616104018 | KAMALESH.M | CSE | A | A | / | / | / | / | / | / | / | / | / | / |
| 4 | 731616104026 | PAVITHIRAN.S | CSE | / | / | / | / | / | / | / | / | / | / | / | / |
| 5 | 731616104035 | SHILPA.B | CSE | / | / | / | / | A | A | / | / | A | A | / | / |
| 6 | 731616104045 | VENMATHI.S | CSE | / | / | / | / | / | / | / | / | / | / | / | / |
| 7 | 731616104047 | VISVESWARAN.B | CSE | / | / | / | / | / | / | / | / | / | / | P | P |
| 8 | 731616104001 | AJITH KUMAR.P | CSE | / | / | / | / | / | / | / | / | / | / | / | / |
| 9 | 731616104017 | JEEVITHA.R | CSE | / | / | / | / | / | / | / | / | / | / | P | P |
| 10 | 731616104010 | GOWRI S | CSE | / | / | / | / | / | / | / | / | / | / | A | A |
| 11 | 731616104021 | MANJULA.R | CSE | / | / | P | P | A | A | / | / | A | A | A | A |
| 12 | 731616106002 | ABISHEK T | ECE | / | / | / | / | / | / | / | / | / | / | / | / |
| 13 | 731616106006 | ANANTH N | ECE | / | / | / | / | / | / | / | / | / | / | / | / |
| 14 | 731616106013 | BHUVANESHWARI P | ECE | / | / | / | / | / | / | / | / | A | A | / | / |
| 15 | 731616106014 | BRAHADEESHWARAN M | ECE | / | / | / | / | A | A | / | / | / | / | P | P |
| 16 | 731616106015 | BRINDHA M | ECE | / | / | / | / | / | / | / | / | / | / | / | / |
| 17 | 731616106017 | DHARANI V | ECE | / | / | / | / | / | / | / | / | / | / | P | P |
| 18 | 731616106019 | DINESHKRISHNA S | ECE | / | / | / | / | / | / | / | / | / | / | / | / |
| 19 | 731616106021 | DURAIRAJ S | ECE | / | / | / | / | / | / | / | / | / | / | / | / |
| 20 | 731616106022 | ELANGO VAN V | ECE | / | / | / | / | / | / | / | / | / | / | / | / |
| 21 | 731616106024 | GOWTHAM M | ECE | / | / | P | P | / | / | / | / | / | / | / | / |
| 22 | 731616106029 | JAYASHRI M | ECE | / | / | / | / | / | / | / | / | / | / | / | / |
| 23 | 731616106031 | KANIMOZHI R | ECE | / | / | / | / | / | / | / | / | / | / | / | / |
| 24 | 731616106032 | KARTHIKEYAN S | ECE | / | / | / | / | / | / | / | / | / | / | / | / |
| 25 | 731616106033 | KARTHIKEYAN V | ECE | / | / | / | / | / | / | / | / | / | / | / | / |
| 26 | 731616106034 | KOKILA K | ECE | / | / | / | / | / | / | / | / | / | / | / | / |
| 27 | 731616106036 | LOGESH KUMAR K | ECE | / | / | / | / | / | / | / | / | / | / | / | / |
| 28 | 731616106040 | MEENA A | ECE | / | / | / | / | / | / | / | / | / | / | / | / |
| 29 | 731616106042 | MONIKA R | ECE | / | / | / | / | / | / | / | / | / | / | / | / |
| 30 | 731616106302 | E.NAVANANDHINI | ECE | P | P | / | / | / | / | / | / | / | / | / | / |
| 31 | 731616106056 | PRIYANKA C | ECE | / | / | / | / | / | / | / | / | / | / | / | / |
| 32 | 731616106062 | SANTHIA G | ECE | / | / | / | / | / | / | / | / | / | / | / | / |
| 33 | 731616106064 | SATHYAMOORTHY K | ECE | / | / | / | / | / | / | / | / | / | / | / | / |
| 34 | 731616106073 | SURIYA E | ECE | / | / | A | A | / | / | A | A | A | A | A | A |
| 35 | 731616106079 | THANGAVEL P | ECE | / | / | / | / | / | / | / | / | / | / | P | P |
| 36 | 731616106082 | VIGNESH R | ECE | / | / | / | / | / | / | / | / | / | / | / | / |
| 37 | 731616105304 | HARIHARAN.R | EEE | / | / | / | / | / | / | / | / | / | / | / | / |

| | | | | | | | | | | | | | | | | |
|-------------------|--------------|-----------------|----|---|----|----|----|----|----|----|----|----|----|----|----|----|
| 39 | 731616205006 | BOOPALAN G | IT | / | / | / | / | / | / | / | / | / | / | / | / | |
| 40 | 731616205017 | KARKULAZHI S | IT | / | / | / | / | / | / | / | / | / | / | / | / | |
| 41 | 731616205019 | KAUSALYA J | IT | / | / | / | / | / | / | / | / | / | / | / | / | |
| 42 | 731616205020 | KIRUBAKARAN R | IT | / | / | / | / | / | / | / | / | / | / | / | / | |
| 43 | 731616205024 | MOUNIKA S | IT | / | / | / | / | / | / | / | / | / | / | / | / | |
| 44 | 731616205027 | PRATHAP KUMAR E | IT | / | / | / | / | / | / | / | / | / | / | / | / | |
| 45 | 731616205033 | SATHAS R | IT | / | / | / | / | / | / | / | / | / | / | / | / | |
| 46 | 731616205039 | SWETHA S | IT | / | / | / | / | / | / | / | / | / | / | P | P | |
| 47 | 731616205003 | ARAVINDH K | IT | / | / | / | / | / | / | / | / | / | / | A | A | |
| PRESENT | | | | | 44 | 44 | 44 | 44 | 43 | 43 | 46 | 46 | 42 | 42 | 37 | 37 |
| ABSENT | | | | | 1 | 1 | 1 | 1 | 0 | 0 | 1 | 1 | 5 | 5 | 4 | 4 |
| PERMISSION | | | | | 2 | 2 | 2 | 2 | 4 | 4 | 0 | 0 | 0 | 0 | 6 | 6 |



PRINCIPAL,
K. S. R. INSTITUTE FOR
ENGINEERING AND TECHNOLOGY,
K. S. R. PALAY NAGAR,
TIRUCHENGODE - 687 215,
NAMAKKAL DL, TAMIL NADU.

Training and Placement Cell

Batch 2 - External Aptitude Training Attendance (Odd Semester)

| BATCH : 2016 - 2020 | | | | Incharge: ECE | | | | Academic Year: 2019 - 2020 | | | | | | | |
|----------------------------|--------------|-------------------|--------|---------------|----|------------|----|----------------------------|----|------------|----|------------|----|------------|----|
| Date of Training Programme | | | | 17.06.2019 | | 18.06.2019 | | 19.06.2019 | | 20.06.2019 | | 21.06.2019 | | 22.06.2019 | |
| S. No | Reg No | Name | Branch | FN | AN | FN | AN | FN | AN | FN | AN | FN | AN | FN | AN |
| 1 | 731616104005 | BARATH.K | CSE | / | / | / | / | / | / | / | / | / | / | / | / |
| 2 | 731616104011 | GOWTHAMAKUMARAN.P | CSE | / | / | / | / | / | / | / | / | / | / | / | / |
| 3 | 731616104018 | KAMALESH.M | CSE | / | / | / | / | / | / | / | / | / | / | / | / |
| 4 | 731616104026 | PAVITHIRAN.S | CSE | / | / | / | / | / | / | / | / | / | / | / | / |
| 5 | 731616104035 | SHILPA.B | CSE | / | / | / | / | / | / | P | P | / | / | / | / |
| 6 | 731616104045 | VENMATHIS | CSE | / | / | / | / | / | / | / | / | / | / | / | / |
| 7 | 731616104047 | VISVESWARAN.B | CSE | / | / | / | / | / | / | / | / | / | / | / | / |
| 8 | 731616104001 | AJITH KUMAR.P | CSE | / | / | / | / | / | / | / | / | / | / | / | / |
| 9 | 731616104017 | JEEVITHA.R | CSE | / | / | / | / | / | / | / | / | / | / | / | / |
| 10 | 731616104010 | GOWRI S | CSE | / | / | / | / | / | / | / | / | / | / | / | / |
| 11 | 731616104021 | MANJULA.R | CSE | / | / | / | / | / | / | / | / | / | / | / | / |
| 12 | 731616106002 | ABISHEK T | ECE | / | / | / | / | / | / | / | / | / | / | / | / |
| 13 | 731616106006 | ANANTH N | ECE | / | / | / | / | / | / | / | / | / | / | / | / |
| 14 | 731616106013 | BHUVANESHWARI P | ECE | / | / | / | / | / | / | / | / | / | / | / | / |
| 15 | 731616106014 | BRAHADEESHWARAN M | ECE | / | / | / | / | / | / | / | / | / | / | / | / |
| 16 | 731616106015 | BRINDHA M | ECE | / | / | / | / | / | / | / | / | / | / | / | / |
| 17 | 731616106017 | DHARANI V | ECE | / | / | / | / | / | / | / | / | / | / | / | / |
| 18 | 731616106019 | DINESHKRISHNA S | ECE | / | / | / | / | / | / | / | / | / | / | / | / |
| 19 | 731616106021 | DURAIRAJ S | ECE | / | / | / | / | / | / | / | / | / | / | / | / |
| 20 | 731616106022 | ELANGO VAN V | ECE | / | / | / | / | / | / | / | / | / | / | / | / |
| 21 | 731616106024 | GOWTHAM M | ECE | / | / | / | / | / | / | / | / | / | / | / | / |
| 22 | 731616106029 | JAYASHRI M | ECE | / | / | / | / | / | / | / | / | / | / | / | / |
| 23 | 731616106031 | KANIMOZHI R | ECE | / | / | / | / | / | / | / | / | / | / | / | / |
| 24 | 731616106032 | KARTHIKEYAN S | ECE | / | / | / | / | / | / | / | / | / | / | P | P |
| 25 | 731616106033 | KARTHIKEYAN V | ECE | / | / | / | / | / | / | / | / | / | / | / | / |
| 26 | 731616106034 | KOKILA K | ECE | / | / | / | / | / | / | / | / | / | / | / | / |
| 27 | 731616106036 | LOGESH KUMAR K | ECE | / | / | / | / | / | / | / | / | / | / | / | / |
| 28 | 731616106040 | MEENA A | ECE | / | / | / | / | / | / | / | / | / | / | / | / |
| 29 | 731616106042 | MONIKA R | ECE | / | / | / | / | / | / | / | / | / | / | / | / |
| 30 | 731616106302 | E.NAVANANDHINI | ECE | / | / | / | / | / | / | / | / | / | / | / | / |
| 31 | 731616106056 | PRIYANKA C | ECE | / | / | / | / | / | / | / | / | / | / | / | / |
| 32 | 731616106062 | SANTHIA G | ECE | / | / | / | / | P | P | / | / | / | / | / | / |
| 33 | 731616106064 | SATHYAMOORTHI K | ECE | / | / | / | / | / | / | / | / | / | / | / | / |
| 34 | 731616106073 | SURIYA E | ECE | P | P | / | / | / | / | / | / | / | / | / | / |
| 35 | 731616106079 | THANGAVEL P | ECE | / | / | / | / | / | / | / | / | / | / | / | / |
| 36 | 731616106082 | VIGNESH R | ECE | / | / | / | / | / | / | / | / | / | / | / | / |
| 37 | 731616105304 | HARIHARAN.R | EEE | / | / | / | / | / | / | / | / | / | / | / | / |

| Sl No | Roll No | Name | DOB | 1 | 2 | 3 | 4 | 5 | 6 | 7 | 8 | 9 | 10 | 11 | 12 |
|-------------------|--------------|-----------------|-----|----|----|----|----|----------------|----------------|----|----|----|----|----|----|
| 39 | 731616205006 | BOOPALAN G | IT | / | / | / | / | / | / | / | / | / | / | / | / |
| 40 | 731616205017 | KARKULAZHI S | IT | P | P | / | / | / | / | / | / | / | / | / | / |
| 41 | 731616205019 | KAUSALYA J | IT | / | / | / | / | / | / | / | / | / | / | / | / |
| 42 | 731616205020 | KIRUBAKARAN R | IT | / | / | / | / | / | / | / | / | / | / | / | / |
| 43 | 731616205024 | MOUNIKA S | IT | / | / | / | / | / | / | / | / | / | / | / | / |
| 44 | 731616205027 | PRATHAP KUMAR E | IT | / | / | / | / | / | / | / | / | / | / | / | / |
| 45 | 731616205033 | SATHAS R | IT | / | / | / | / | / | / | / | / | / | / | / | / |
| 46 | 731616205039 | SWETHA S | IT | / | / | / | / | / | / | / | / | / | / | / | / |
| 47 | 731616205003 | ARAVINDH K | IT | / | / | / | / | / | / | / | / | / | P | / | / |
| PRESENT | | | | 45 | 45 | 47 | 47 | 45 | 45 | 46 | 46 | 47 | 46 | 45 | 45 |
| ABSENT | | | | 0 | 0 | 0 | 0 | 0 | 0 | 0 | 0 | 0 | 0 | 0 | 0 |
| PERMISSION | | | | 2 | 2 | 0 | 0 | 0 ¹ | 0 ¹ | 1 | 1 | 0 | 1 | 2 | 2 |

PRINCIPAL,
K. S. R. INSTITUTE FOR
ENGINEERING AND TECHNOLOGY,
K. S. P. KALAI NADAR,
TIRUCHENGODE - 637 215,
NAMAKKAL Dt, TAMIL NADU.

| BATCH : 2016 - 2020 | | | | Incharge: EEE | | | | Academic Year: 2019 - 2020 | | | | | | | |
|----------------------------|--------------|------------------|--------|---------------|----|------------|----|----------------------------|----|------------|----|------------|----|------------|----|
| Date of Training Programme | | | | 10.06.2019 | | 11.06.2019 | | 12.06.2019 | | 13.06.2019 | | 14.06.2019 | | 15.06.2019 | |
| S.No | Reg No | Name | Branch | FN | AN | FN | AN | FN | AN | FN | AN | FN | AN | FN | AN |
| 1 | 731616105002 | AJITHA P | EEE | / | / | / | / | / | / | / | / | / | / | / | / |
| 2 | 731616105004 | ANBALAGAN M | EEE | / | / | / | / | / | / | / | / | / | / | / | / |
| 3 | 731616105005 | ARAVIND R | EEE | / | / | / | / | / | / | A | A | A | A | A | A |
| 4 | 731616105006 | BHARATH S | EEE | / | / | / | / | / | / | / | / | / | / | P | P |
| 5 | 731616105008 | BOOPATHI M | EEE | / | / | / | / | / | / | / | / | / | / | / | / |
| 6 | 731616105010 | DIVYADEVI V | EEE | / | / | / | / | / | / | P | P | / | / | / | / |
| 7 | 731616105012 | INIYA DHARINI R | EEE | / | / | / | / | / | / | / | / | / | / | / | / |
| 8 | 731616105014 | JEEVA M | EEE | / | / | / | / | / | / | / | / | / | / | / | / |
| 9 | 731616105015 | JEEVA R | EEE | / | / | / | / | / | / | / | / | / | / | / | / |
| 10 | 731616105017 | KANIMOZHI V | EEE | / | / | / | / | / | / | / | / | / | / | / | / |
| | 731616105020 | KAVIYA M | EEE | / | / | / | / | / | / | / | / | / | / | / | / |
| 12 | 731616105021 | LATHA S | EEE | / | / | / | / | / | / | / | / | / | / | / | / |
| 13 | 731616105022 | LOGESHWARAN V | EEE | / | / | / | / | / | / | / | / | / | / | / | / |
| 14 | 731616105023 | MADHUMITHA JS | EEE | / | / | / | / | / | / | / | / | / | / | / | / |
| 15 | 731616105024 | MANOJKUMAR V | EEE | / | / | / | / | / | / | / | / | / | / | / | / |
| 16 | 731616105028 | MONISHA S | EEE | P | P | / | / | / | / | / | / | / | / | / | / |
| 17 | 731616105029 | MUGESH.M | EEE | / | / | P | P | P | P | / | / | / | / | / | / |
| 18 | 731616105030 | MYTHILI N | EEE | / | / | / | / | / | / | A | A | / | / | / | / |
| 19 | 731616105032 | NANDHINI M | EEE | / | / | / | / | / | / | / | / | / | / | / | / |
| 20 | 731616105033 | NAVANEETHAN S | EEE | / | / | / | / | / | / | P | P | / | / | / | / |
| 21 | 731616105035 | PIREETHIA | EEE | / | / | / | / | / | / | / | / | / | / | / | / |
| 22 | 731616105036 | PRAKASH.S.P | EEE | / | / | / | / | / | / | / | / | / | / | / | / |
| 23 | 731616105037 | PRAVEEN.D | EEE | / | / | / | / | / | / | / | / | P | P | / | / |
| | 731616105038 | PRAVIN.R | EEE | / | / | / | / | / | / | / | / | / | / | / | / |
| 25 | 731616105039 | PREETHA.E | EEE | / | / | / | / | / | / | / | / | / | / | / | / |
| 26 | 731616105040 | PREMKUMAR.G | EEE | / | / | / | / | / | / | / | / | / | / | / | / |
| 27 | 731616105041 | SARANYA.P | EEE | / | / | / | / | / | / | P | P | / | / | / | / |
| 28 | 731616105042 | SARAVANAN.V | EEE | / | / | / | / | / | / | / | / | / | / | / | / |
| 29 | 731616105045 | SUJITHA.E | EEE | / | / | / | / | / | / | P | P | / | / | / | / |
| 30 | 731616105046 | SUVETHA.T | EEE | / | / | / | / | / | / | / | / | / | / | / | / |
| 31 | 731616105047 | VIVEK.V | EEE | / | / | / | / | / | / | / | / | / | / | / | / |
| 32 | 731616105303 | EMAIYA.K | EEE | / | / | / | / | / | / | / | / | / | / | / | / |
| 33 | 731616105306 | RATHNAKUMAR.V | EEE | / | / | / | / | / | / | / | / | / | / | / | / |
| 34 | 731616205001 | AHAMED FAISHAL H | IT | / | / | / | / | / | / | / | / | / | / | / | / |
| 35 | 731616205012 | INDHUMATHI S | IT | / | / | / | / | / | / | / | / | / | / | / | / |
| 36 | 731616205018 | KARTHIKA M | IT | / | / | / | / | / | / | / | / | / | / | / | / |
| 37 | 731616106008 | ARULIEESWARAN R | ECE | / | / | A | A | / | / | / | / | / | / | / | / |

| | | | | | | | | | | | | | | | |
|-------------------|--------------|------------------|-----|----|----|----|----|----|----|----|----|----|----|----|----|
| 38 | 731616106046 | NANDHAKUMARAN R | ECE | / | / | / | / | / | / | / | / | / | / | / | / |
| 39 | 731616106054 | PRIYADHARSHINI S | ECE | / | / | / | / | / | / | / | / | / | / | / | / |
| 40 | 731616106066 | SHARVESH RAM K R | ECE | / | / | / | / | / | / | / | / | / | / | / | / |
| 41 | 731616106067 | SHOWMIYA M | ECE | / | / | / | / | / | / | / | / | / | / | / | / |
| 42 | 731616106075 | SYED SALMAN N | ECE | / | / | / | / | / | / | / | / | / | / | / | / |
| 43 | 731616106080 | THARANYA P | ECE | / | / | / | / | / | / | A | A | / | / | / | / |
| 44 | 731616106058 | RAMYA SRI E | ECE | / | / | / | / | / | / | P | P | / | / | / | / |
| PRESENT | | | | 43 | 43 | 42 | 42 | 43 | 43 | 35 | 35 | 42 | 42 | 42 | 42 |
| ABSENT | | | | 0 | 0 | 1 | 1 | 0 | 0 | 3 | 3 | 1 | 1 | 1 | 1 |
| PERMISSION | | | | 1 | 1 | 1 | 1 | 1 | 1 | 5 | 5 | 1 | 1 | 1 | 1 |

PRINCIPAL,
K. S. R. INSTITUTE FOR
ENGINEERING AND TECHNOLOGY,
K. S. R. ROAD, SOLLAR,
TIRUCHENGOORE - 637 215,
NAMAKKAL DISTRICT, TAMIL NADU.

Batch 3 - External Aptitude Training Attendance (Odd Semester)

| BATCH : 2016 - 2020 | | | | Incharge: EEE | | | | Academic Year: 2019 - 2020 | | | | | | | |
|----------------------------|--------------|------------------|--------|---------------|----|------------|----|----------------------------|----|------------|----|------------|----|------------|----|
| Date of Training Programme | | | | 17.06.2019 | | 18.06.2019 | | 19.06.2019 | | 20.06.2019 | | 21.06.2019 | | 22.06.2019 | |
| S. No | Reg No | Name | Branch | FN | AN | FN | AN | FN | AN | FN | AN | FN | AN | FN | AN |
| 1 | 731616105002 | AJITHA P | EEE | / | / | / | / | / | / | / | / | / | / | / | / |
| 2 | 731616105004 | ANBALAGAN M | EEE | / | / | / | / | / | / | / | / | / | / | A | A |
| 3 | 731616105005 | ARAVIND R | EEE | / | / | / | / | / | / | / | / | / | / | / | / |
| 4 | 731616105006 | BHARATH S | EEE | / | / | / | / | / | / | / | / | / | / | / | / |
| 5 | 731616105008 | BOOPATHI M | EEE | / | / | / | / | / | / | / | / | / | / | / | / |
| 6 | 731616105010 | DIVYADEVI V | EEE | / | / | / | / | / | / | / | / | / | / | / | / |
| 7 | 731616105012 | INIYA DHARINI R | EEE | / | / | / | / | / | / | / | / | / | / | / | / |
| 8 | 731616105014 | JEEVA M | EEE | / | / | / | / | / | / | / | / | / | / | / | / |
| 9 | 731616105015 | JEEVA R | EEE | / | / | / | / | / | / | / | / | / | / | / | / |
| 10 | 731616105017 | KANIMOZHI V | EEE | / | / | / | / | / | / | / | / | / | / | / | / |
| | 731616105020 | KAVIYA M | EEE | / | / | / | / | / | / | / | / | P | P | / | / |
| 12 | 731616105021 | LATHA S | EEE | / | / | / | / | / | / | / | / | / | / | / | / |
| 13 | 731616105022 | LOGESHWARAN V | EEE | / | / | / | / | / | / | / | / | / | / | / | / |
| 14 | 731616105023 | MADHUMITHA J S | EEE | / | / | / | / | / | / | / | / | / | / | / | / |
| 15 | 731616105024 | MANOJKUMAR V | EEE | / | / | / | / | / | / | / | / | / | / | / | / |
| 16 | 731616105028 | MONISHA S | EEE | / | / | / | / | / | / | / | / | / | / | / | / |
| 17 | 731616105029 | MUGESH.M | EEE | / | / | / | / | / | / | / | / | / | / | / | / |
| 18 | 731616105030 | MYTHILI N | EEE | / | / | / | / | / | / | / | / | / | / | / | / |
| 19 | 731616105032 | NANDHINI M | EEE | / | / | / | / | / | / | / | / | / | / | / | / |
| 20 | 731616105033 | NAVANEETHAN S | EEE | / | / | / | / | / | / | / | / | / | / | P | P |
| 21 | 731616105035 | PIREETHI.A | EEE | / | / | / | / | / | / | / | / | / | / | / | / |
| 22 | 731616105036 | PRAKASH.S.P | EEE | / | / | / | / | / | / | / | / | / | / | / | / |
| 23 | 731616105037 | PRAVEEN.D | EEE | / | / | / | / | / | / | / | / | / | / | / | / |
| | 731616105038 | PRAVIN.R | EEE | / | / | / | / | / | / | / | / | / | / | / | / |
| 25 | 731616105039 | PREETHA.E | EEE | / | / | / | / | / | / | / | / | / | / | / | / |
| 26 | 731616105040 | PREMKUMAR.G | EEE | / | / | / | / | / | / | / | / | / | / | / | / |
| 27 | 731616105041 | SARANYA.P | EEE | / | / | / | / | / | / | / | / | / | / | / | / |
| 28 | 731616105042 | SARAVANAN.V | EEE | / | / | / | / | / | / | / | / | / | / | / | / |
| 29 | 731616105045 | SUJITHA.E | EEE | / | / | / | / | / | / | / | / | P | P | A | A |
| 30 | 731616105046 | SUVETHA.T | EEE | / | / | / | / | / | / | / | / | / | / | P | P |
| 31 | 731616105047 | VIVEK.V | EEE | / | / | / | / | / | / | / | / | / | / | / | / |
| 32 | 731616105303 | EMAIYA.K | EEE | / | / | / | / | / | / | / | / | / | / | / | / |
| 33 | 731616105306 | RATHNAKUMAR.V | EEE | / | / | / | / | / | / | / | / | / | / | A | A |
| 34 | 731616205001 | AHAMED FAISHAL H | IT | / | / | / | / | P | P | / | / | / | / | / | / |
| 35 | 731616205012 | INDHUMATHI S | IT | / | / | / | / | / | / | / | / | / | / | / | / |
| 36 | 731616205018 | KARTHIKA M | IT | / | / | / | / | / | / | / | / | / | / | / | / |
| 37 | 731616106008 | ARULIEESWARAN R | ECE | / | / | / | / | / | / | / | / | / | / | / | / |

| | | | | | | | | | | | | | | | |
|-------------------|--------------|------------------|-----|-----------|-----------|-----------|-----------|-----------|-----------|-----------|-----------|-----------|-----------|-----------|-----------|
| 39 | 731616106054 | PRIYADHARSHINI S | ECE | / | / | / | / | / | / | / | / | / | / | / | / |
| 40 | 731616106066 | SHARVESH RAM K R | ECE | / | / | / | / | / | / | / | / | / | / | / | / |
| 41 | 731616106067 | SHOWMIYA M | ECE | / | / | / | / | / | / | / | / | / | / | / | / |
| 42 | 731616106075 | SYED SALMAN N | ECE | / | / | / | / | / | / | / | / | / | / | / | / |
| 43 | 731616106080 | THARANYA P | ECE | / | / | / | / | / | / | / | / | / | / | / | / |
| 44 | 731616106058 | RAMYA SRI E | ECE | / | / | / | / | / | / | / | / | / | / | / | / |
| PRESENT | | | | 44 | 44 | 44 | 44 | 43 | 43 | 44 | 44 | 42 | 42 | 39 | 39 |
| ABSENT | | | | 0 | 0 | 0 | 0 | 0 | 0 | 0 | 0 | 0 | 0 | 3 | 3 |
| PERMISSION | | | | 0 | 0 | 0 | 0 | 1 | 1 | 0 | 0 | 2 | 2 | 2 | 2 |

PRINCIPAL,
K. S. R. INSTITUTE FOR
ENGINEERING AND TECHNOLOGY,
K. S. R. RAJAKOTTAI,
TIRUCHENGODE - 637 215,
NAMAKKAL Dt, TAMIL NADU.



Name of the Student: Venmathi. S Branch: CSE

Year / Sem: IV / VI

1. Name of the Training: External Aptitude Training

2. Name of the Trainer: Six Phase Training Agency

3. Students rating of Trainers :

| S. No. | Date | Subject | Rating (✓) | | | |
|--------|--------------------------|----------------------|------------|-----------|------|---------|
| | | | Excellent | Very good | Good | Average |
| 1 | 10.6.19 to 15.6.19 | Aptitude Training | ✓ | | | |

4. Two positive points about the programme:

Informative Session

5. Suggestions for improvement:

—

Date: 15/6/19

Venmathi
Signature



Name of the Student: Gowtham. M. Branch: ECE

Year / Sem: VII / IV

1. Name of the Training: External Aptitude training

2. Name of the Trainer: Six Phase Training Academy.

3. Students rating of Trainers :

| S. No. | Date | Subject | Rating (✓) | | | |
|--------|---------------------------|----------------------|------------|-----------|------|---------|
| | | | Excellent | Very good | Good | Average |
| 1 | 10.6.19 to 15.6.19. | Aptitude training | | ✓ | | |

4. Two positive points about the programme:

Practical session is needed.

5. Suggestions for improvement:

Date: 15/6/19.

PRINCIPAL,
K. S. R. INSTITUTE FOR
ENGINEERING AND TECHNOLOGY,
K. S. R. INSTITUTE FOR
TIRUCHENGODE - 637 215,
NAMAKKAL DISTRICT, TAMIL NADU.

Gowtham
Signature

**K S R INSTITUTE FOR ENGINEERING AND TECHNOLOGY
TIRUCHENGODE - 637 215**

TRAINING PROGRAMME FEEDBACK FORM



Name of the Student: Arjun R Branch: CSE

Year / Sem: IV/VII

- Name of the Training : External Aptitude Training
- Name of the Trainer : Six Phase Training Agency
- Students rating of Trainers :

| S. No. | Date | Subject | Rating (✓) | | | |
|--------|----------|----------------------------|------------|-----------|------|---------|
| | | | Excellent | Very good | Good | Average |
| 1 | 22.06.19 | External Aptitude Training | | ✓ | | |

4. Two positive points about the programme:

The session was very useful & very easy to solve aptitude

5. Suggestions for improvement:

Need more example for aptitude sums.

Date: 22.06.19

R. Arun
Signature

**K S R INSTITUTE FOR ENGINEERING AND TECHNOLOGY
TIRUCHENGODE - 637 215**

TRAINING PROGRAMME FEEDBACK FORM



Name of the Student: Aravind Branch: IT

Year / Sem: IV/VII

- Name of the Training : External Aptitude Training
- Name of the Trainer : Six Phase Training Agency
- Students rating of Trainers :

| S. No. | Date | Subject | Rating (✓) | | | |
|--------|---------|-----------------------|------------|-----------|------|---------|
| | | | Excellent | Very good | Good | Average |
| 1 | 22.6.19 | External apt training | | ✓ | | |

4. Two positive points about the programme:

Short cut method was good.

5. Suggestions for improvement:

Date: 22/6/19

PRINCIPAL,
K. S. R. INSTITUTE FOR
ENGINEERING AND TECHNOLOGY,
K. S. R. KALAI TEGAR,
TIRUCHENGODE - 637 215,
NAMAKKAL DISTRICT, TAMIL NADU.

**K S R INSTITUTE FOR ENGINEERING AND TECHNOLOGY
TIRUCHENGODE - 637 215**

TRAINING PROGRAMME FEEDBACK FORM



Name of the Student: B. Swetha Branch: CSE

Year / Sem: IV / VII

1. Name of the Training: External Aptitude Training

2. Name of the Trainer: Six Phase Training Agency

3. Students rating of Trainers: 5

| S. No. | Date | Subject | Rating (✓) | | | |
|--------|--------------------|----------------------------|------------|-----------|------|---------|
| | | | Excellent | Very good | Good | Average |
| 1 | 10-6-19 to 15-6-19 | External Aptitude Training | ✓ | | | |

4. Two positive points about the programme:
- Shortcut method was easy to understand.

5. Suggestions for improvement:

Date: 15/6/19

B. Swetha
Signature

**K S R INSTITUTE FOR ENGINEERING AND TECHNOLOGY
TIRUCHENGODE - 637 215**

TRAINING PROGRAMME FEEDBACK FORM



Name of the Student: Manimuthu - M Branch: ECE

Year / Sem: IV / VII

1. Name of the Training: External Aptitude Training

2. Name of the Trainer: Six Phase Training Agency

3. Students rating of Trainers:

| S. No. | Date | Subject | Rating (✓) | | | |
|--------|--------------------|-------------------|------------|-----------|------|---------|
| | | | Excellent | Very good | Good | Average |
| 1 | 10-6-19 to 15-6-19 | Aptitude Training | | ✓ | | |

4. Two positive points about the programme:
Interesting Content

5. Suggestions for improvement:
Need more classes

Date: 15/6/19

Manimuthu - M
Signature

**K S R INSTITUTE FOR ENGINEERING AND TECHNOLOGY
TIRUCHENGODE - 637 215**

TRAINING PROGRAMME FEEDBACK FORM



Name of the Student: S. SWETHA Branch: IT

Year / Sem: IV / VII

1. Name of the Training : EXTERNAL APTITUDE TRAINING

2. Name of the Trainer : SIX PHASE TRAINING AGENCY

3. Students rating of Trainers :

| S. No. | Date | Subject | Rating (✓) | | | |
|--------|----------|----------------------------|------------|-----------|------|---------|
| | | | Excellent | Very good | Good | Average |
| 1 | 22.06.19 | EXTERNAL APTITUDE TRAINING | ✓ | | | |

4. Two positive points about the programme:

The Aptitude training was handled very nice.

5. Suggestions for improvement:

Need some detailed notes

Date: 22.06.19

S. Swetha
Signature

**K S R INSTITUTE FOR ENGINEERING AND TECHNOLOGY
TIRUCHENGODE - 637 215**

TRAINING PROGRAMME FEEDBACK FORM



Name of the Student: Rowan S Branch: CCB

Year / Sem: VI / VII

1. Name of the Training : External Aptitude Training

2. Name of the Trainer : Six Phase Training Agency

3. Students rating of Trainers :

| S. No. | Date | Subject | Rating (✓) | | | |
|--------|---------|----------------------------|------------|-----------|------|---------|
| | | | Excellent | Very good | Good | Average |
| 1 | 22/6/19 | External Aptitude Training | ✓ | | | |

4. Two positive points about the programme:

Nice session, Knowledgeable Person

5. Suggestions for improvement:

Need some notes, like Pdf
K. S. R. INSTITUTE FOR ENGINEERING AND TECHNOLOGY
T. S. R. KAVI NAGAR,
TIRUCHENGODE - 637 215,
NAMAKKAL Dt, TAMIL NADU.

Date: 22/6/19

Rowan S.
Signature

**K S R INSTITUTE FOR ENGINEERING AND TECHNOLOGY
TIRUCHENGODE - 637 215**

TRAINING PROGRAMME FEEDBACK FORM



Name of the Student: Jeena R Branch: EEE

Year / Sem: IV / VII

1. Name of the Training: External Aptitude Training

2. Name of the Trainer: Six Phase Training Agency

3. Students rating of Trainers :

| S. No. | Date | Subject | Rating (✓) | | | |
|--------|--------------------------|-------------------|------------|-----------|------|---------|
| | | | Excellent | Very good | Good | Average |
| 1 | 10.6.19 to 15.6.19 | Aptitude Training | ✓ | | | |

4. Two positive points about the programme:

Good session

5. Suggestions for improvement:

Date: 15/6/19

Jeena R
Signature

**K S R INSTITUTE FOR ENGINEERING AND TECHNOLOGY
TIRUCHENGODE - 637 215**

TRAINING PROGRAMME FEEDBACK FORM



Name of the Student: Syed Salman N Branch: _____

Year / Sem: IV / VII

1. Name of the Training: External Aptitude Training

2. Name of the Trainer: Six Phase Training Agency

3. Students rating of Trainers :

| S. No. | Date | Subject | Rating (✓) | | | |
|--------|--------------------------|-------------------|------------|-----------|------|---------|
| | | | Excellent | Very good | Good | Average |
| 1 | 10.6.19 to 15.6.19 | Aptitude Training | | ✓ | | |

4. Two positive points about the programme:

Session was easy to understand.

5. Suggestions for improvement:

Date: 15/6/19

PRINCIPAL,
K. S. R. INSTITUTE FOR
ENGINEERING AND TECHNOLOGY,
K. S. R. MAIN ROAD,
TIRUCHENGODE - 637 215,
NAMAKKAL Dt, TAMIL NADU.

Syed Salman N
Signature

**K S R INSTITUTE FOR ENGINEERING AND TECHNOLOGY
TIRUCHENGODE - 637 215**

TRAINING PROGRAMME FEEDBACK FORM



Name of the Student: Aarind. R. Branch: EEE

Year / Sem: IV / VII

1. Name of the Training : External Aptitude Training

2. Name of the Trainer : Six Phase Training Academy

3. Students rating of Trainers :

| S. No. | Date | Subject | Rating (✓) | | | |
|--------|--------------------------|----------------------------------|------------|-----------|------|---------|
| | | | Excellent | Very good | Good | Average |
| 1 | 17.6.19 to 22.6.19 | External Aptitude Training | ✓ | | | |

4. Two positive points about the programme:

Real time Session
Clearly understood

5. Suggestions for improvement:

Date: 22/6/19

Aarind. R.
Signature

**K S R INSTITUTE FOR ENGINEERING AND TECHNOLOGY
TIRUCHENGODE - 637 215**

TRAINING PROGRAMME FEEDBACK FORM



Name of the Student: Vivek V Branch: EEE

Year / Sem: IV / VII

1. Name of the Training : External aptitude training

2. Name of the Trainer : Six Phase Training Agency

3. Students rating of Trainers :

| S. No. | Date | Subject | Rating (✓) | | | |
|--------|--------------------|-------------------------------|------------|-----------|------|---------|
| | | | Excellent | Very good | Good | Average |
| 1 | 17.6.19 22.6.19 | External Aptitude training | ✓ | | | |

4. Two positive points about the programme:

Real time session, was good

5. Suggestions for improvement:

Date: 22/6/19

PRINCIPAL,
K. S. R. INSTITUTE FOR
ENGINEERING AND TECHNOLOGY,
K. S. R. KALANGAR,
TIRUCHENGODE - 637 215,
NAMAKKAL DI, TAMIL NADU.

Vivek V
Signature

Ref: KSRIET/T&P/CIR/2019-20

Date: 29.06.2019

This is to inform that all the HoD's, Faculty members and Training & Placement coordinators that External Aptitude Training programme for III & IV year Mechanical students by Talent 2 Success & III year CSE, ECE,EEE & IT students by FACE for the academic year 2019 - 2020 (Odd Sem) is scheduled as given below. All the registered students should attend the Training Programme without fail. If any student skips this Training Programme he / she will not be permitted for any further Training Programme and campus recruitment process. Proper Dress Code is mandatory.

| S.No | Dates | Branch | Students | Venue | Assessment Venue |
|------|------------------------------|--|---|---|---|
| 1 | 01.07.2019 | MECH (IV Year) by T2S | MECH - 85 | Batch 1 - MIC 202 Batch 2 - MIC 204 | Batch 1 - CAD Lab Batch 2 - Virtusa Lab |
| 2 | To 06.07.2019 | CSE, ECE, EEE & IT (III Year) by FACE | CSE - 34, ECE - 64, EEE - 43 & IT - 38 | Batch 1 - M 106 Batch 2 - M 108 Batch 3 - M 109 | Batch1 - CSE Lab Batch2 - IT Lab Batch3 - ECE Lab |
| 3 | 22.7.2019 To 27.7.2019 | MECH (III Year) by T2S | MECH - 66 | MECH Block | CAD Lab |

Y. Kaluth
T&P OFFICER

[Signature]
T&P COORDINATOR

[Signature]
PRINCIPAL

Copy to:

1. All HoDs
2. Notice Board.

Session Timings:

Forenoon Session: 09.00 AM to 12.30 PM Break: 10.45 AM to 11.00 AM & 3.00PM - 03.15PM

Afternoon Session: 01.30 PM to 04.45 PM Lunch: 12.30 PM to 01.30 PM

Assessments Session: 05.15 PM - 06.40 PM

KSRIET
INSTITUTE FOR
ENGINEERING AND TECHNOLOGY,
TIRUCHENGODE,
TAMIL NADU - 637 215.

| CODE | TOPICS |
|------|---|
| Q1 | Numbers(LCM & HCF,Factors, Problem on Numbers,Divisibility Rule,Unit Digit, Reminders), Averages,Ratio & Proportion,Partnership,Allegation & Mixtures |
| Q2 | Percentage,Profit & loss,Interest Calculation |
| Q3 | Time Speed & Distance, Time & Work, Chain Rule |
| Q4 | Permutation,Combination&Probability, DI & DS |
| R | Number Series ,Syllogism, Blood Relation, Analogy, Coding & Decoding, Direction |
| V | Synonyms,Antonyms,Spotting Errors,Sentence Correction,Sentence Improvement,One word Substitutes,Spelling Test,Idioms & Phrases,Cloze Test,Comprehension |

| | KSR | IET | |
|------------|-----|---------|---------|
| | | BATCH 7 | BATCH 8 |
| 01-07-2019 | V | Q1 | Q1 |
| 02-07-2019 | Q2 | Q2 | Q2 |
| 03-07-2019 | Q3 | V | V |
| 04-07-2019 | R | Q4 | Q4 |
| 05-07-2019 | Q1 | R | R |
| 06-07-2019 | Q4 | Q3 | Q3 |

| | KSR | IET | |
|------------|-----------|-----------|-----------|
| | | BATCH 7 | BATCH 8 |
| 01-07-2019 | SINDHU | BHOOPATHY | BHOOPATHY |
| 02-07-2019 | BHOOPATHY | MANOJ | MANOJ |
| 03-07-2019 | MANOJ | PREETHI | PREETHI |
| 04-07-2019 | PREETHI | PRAJESH | PRAJESH |
| 05-07-2019 | PRAJESH | SUGANYA | SUGANYA |
| 06-07-2019 | PREMA | SAMPATH | SAMPATH |



 PRINCIPAL,
 K. S. R. INSTITUTE FOR
 ENGINEERING & TECHNOLOGY,
 K. S. R. NAGAR,
 TIRUCHENGODE - 637 215,
 NAMAKKAL DISTRICT, TAMIL NADU.

MECH A Batch 1 - Talent 2 Success Aptitude Training Attendance (Odd Semester)

| BATCH : 2017 - 2021 | | | | Hall No: MIC 202 | | | | Academic Year: 2019 - 2020 | | | | | | | |
|---------------------------|--------------|------------------|--------|------------------|----|----------|----|----------------------------|----|----------|----|----------|----|----------|----|
| Date of Trainng Programme | | | | 01.07.19 | | 02.07.19 | | 03.07.19 | | 04.07.19 | | 05.07.19 | | 06.07.19 | |
| S. No | Reg No | Name | Branch | FN | AN | FN | AN | FN | AN | FN | AN | FN | AN | FN | AN |
| 1 | 731616114003 | ANNAMALAI K | MECH | / | / | / | / | / | / | / | / | / | / | / | / |
| 2 | 731616114004 | ARSHATH S | MECH | / | / | / | / | / | / | / | / | / | / | / | / |
| 3 | 731616114005 | ASWINKUMAR S | MECH | / | / | / | / | / | / | / | / | / | / | / | / |
| 4 | 731616114007 | BOOPATHI RAJA E | MECH | / | / | / | / | / | / | / | / | / | / | / | / |
| 5 | 731616114011 | DEEPAK R | MECH | P | P | P | P | / | / | / | / | / | / | / | / |
| 6 | 731616114012 | DHAYANIDHI M | MECH | OD | OD | OD | OD | / | / | / | / | / | / | / | / |
| 7 | 731616114013 | DHEVENDRAN E | MECH | / | / | / | / | / | / | / | / | / | / | / | / |
| 8 | 731616114015 | DINESH KUMAR C | MECH | / | / | / | / | / | / | / | / | / | / | / | / |
| 9 | 731616114017 | GOKULRAJ P | MECH | / | / | / | / | / | / | / | / | / | / | / | / |
| 10 | 731616114018 | GOPINATH G | MECH | / | / | / | / | / | / | / | / | / | / | / | / |
| 11 | 731616114019 | GOVINDASAMY A | MECH | / | / | / | / | / | / | / | / | / | / | / | / |
| 12 | 731616114020 | GOWTHAM P | MECH | / | / | / | / | / | / | / | / | / | / | / | / |
| 13 | 731616114021 | GUNASEKARAN R | MECH | / | / | / | / | / | / | / | / | / | / | / | / |
| 14 | 731616114022 | HARIHARAN M | MECH | / | / | / | / | / | / | / | / | / | / | / | / |
| 15 | 731616114023 | HARIHARAN S | MECH | / | / | / | / | / | / | / | / | / | / | / | / |
| 16 | 731616114024 | HARI SHANKAR P | MECH | / | / | / | / | / | / | / | / | / | / | / | / |
| 17 | 731616114025 | INBARASAN C | MECH | / | / | / | / | / | / | / | / | / | / | / | / |
| 18 | 731616114027 | JAYAMURUGAN K S | MECH | / | / | / | / | / | / | / | / | / | / | / | / |
| 19 | 731616114028 | JEEVA K | MECH | / | / | / | / | / | / | / | / | / | / | / | / |
| 20 | 731616114029 | JEEVA M | MECH | / | / | / | / | / | / | / | / | / | / | / | / |
| 21 | 731616114030 | JESTINRAJ K | MECH | / | / | / | / | / | / | / | / | / | / | / | / |
| 22 | 731616114031 | JOSHUA Y | MECH | / | / | / | / | / | / | / | / | P | P | P | P |
| 23 | 731616114032 | KALEESWARAN D | MECH | / | / | / | / | / | / | / | / | / | / | / | / |
| 24 | 731616114033 | KAROLE INFANTO D | MECH | / | / | / | / | / | / | / | / | P | P | / | / |
| 25 | 731616114034 | KARTHIKEYAN P | MECH | / | / | / | / | / | / | / | / | / | / | / | / |
| 26 | 731616114035 | KAVIN P | MECH | / | / | / | / | / | / | / | / | / | / | / | / |
| 27 | 731616114040 | KIRUBAKARAN M | MECH | / | / | / | / | / | / | / | / | / | / | / | / |

K. S. R. INSTITUTE FOR ENGINEERING AND TECHNOLOGY,
TIRUCHENGODE - 637 215,
NAMAKKAL Dt., TAMIL NADU.

| Date of Training Programme | | | | 01.07.19 | | 02.07.19 | | 03.07.19 | | 04.07.19 | | 05.07.19 | | 06.07.19 | |
|----------------------------|--------------|-----------------------|--------|----------|----|----------|----|----------|----|----------|----|----------|----|----------|----|
| S. No | Reg No | Name | Branch | FN | AN | FN | AN | FN | AN | FN | AN | FN | AN | FN | AN |
| 28 | 731616114041 | LAKSHMI NARAYANAN R | MECH | / | / | / | / | / | / | / | / | / | / | / | / |
| 29 | 731616114042 | LOGESH N | MECH | / | / | / | / | / | / | / | / | / | / | / | / |
| 30 | 731616114044 | MADHANKUMAR L | MECH | / | / | / | / | / | / | / | / | / | / | / | / |
| 31 | 731616114045 | MAGESWARAN A | MECH | / | / | / | / | / | / | / | / | / | / | / | / |
| 32 | 731616114046 | MANIKANDAN V | MECH | / | / | / | / | A | / | / | / | / | / | / | / |
| 33 | 731616114047 | MANOJKUMAR K | MECH | / | / | / | / | / | / | / | / | / | / | / | / |
| 34 | 731616114048 | MOHAMMED NIHAL R | MECH | / | / | / | / | / | / | / | / | / | / | / | / |
| 35 | 731616114049 | MOHANAKRISHNAN D | MECH | / | / | / | / | / | / | / | / | / | / | / | / |
| 36 | 731616114050 | MOHAN ARJUN KUMARAVEL | MECH | / | / | / | / | / | / | / | / | / | / | / | / |
| 37 | 731616114051 | MOHANRAJ B | MECH | / | / | / | / | / | / | / | / | / | / | / | / |
| 38 | 731616114302 | BALAJI M | MECH | / | / | / | / | / | / | / | / | / | / | / | / |
| 39 | 731616114305 | JEEVANANDHAM N | MECH | / | / | / | / | / | / | / | / | / | / | / | / |
| 40 | 731616114306 | KARTHI S | MECH | / | / | / | / | / | / | / | / | / | / | / | / |
| 41 | 731616114308 | PRASANTH S | MECH | / | / | / | / | / | / | / | / | / | / | / | / |
| PRESENT | | | | 39 | 39 | 39 | 39 | 40 | 41 | 41 | 41 | 39 | 39 | 40 | 40 |
| ABSENT | | | | 0 | 0 | 0 | 0 | 1 | 0 | 0 | 0 | 0 | 0 | 0 | 0 |
| PERMISSION | | | | 2 | 2 | 2 | 2 | 0 | 0 | 0 | 0 | 2 | 2 | 1 | 1 |

PRINCIPAL,
K. S. R. INSTITUTE FOR
ENGINEERING AND TECHNOLOGY,
K. S. R. KALUJAGAR,
TIRUCHENGODE - 637 215,
NAMAKKAL DISTRICT, TAMIL NADU.

MECH B Batch 2 - Talent 2 Success Aptitude Training Attendance (Odd Semester)

| BATCH : 2016 - 2020 | | | | Hall No: MIC 204 | | | | Academic Year: 2019 - 2020 | | | | | | | |
|----------------------------|--------------|-------------------------|--------|------------------|----|----------|----|----------------------------|----|----------|----|----------|----|----------|----|
| Date of Training Programme | | | | 01.07.19 | | 02.07.19 | | 03.07.19 | | 04.07.19 | | 05.07.19 | | 06.07.19 | |
| S. No | Reg No | Name | Branch | FN | AN | FN | AN | FN | AN | FN | AN | FN | AN | FN | AN |
| 1 | 731616114052 | NAMBIRAJ J | MECH | / | / | / | / | / | / | / | / | / | / | / | / |
| 2 | 731616114053 | NANDHA GOBAL S | MECH | / | / | / | / | / | / | / | / | / | / | / | / |
| 3 | 731616114054 | NAVINKUMAR M | MECH | / | / | / | / | / | / | P | P | / | / | / | / |
| 4 | 731616114055 | PARTHASARATHY R | MECH | / | / | / | / | / | / | / | / | / | / | / | / |
| 5 | 731616114056 | PRABAKARAN S | MECH | / | / | / | / | / | / | / | / | / | / | / | / |
| 6 | 731616114057 | PRABHAKARAN M | MECH | / | / | / | / | / | / | / | / | / | / | / | / |
| 7 | 731616114058 | PRASANTH R | MECH | / | / | / | / | / | / | / | / | / | / | / | / |
| 8 | 731616114059 | PRAVEEN R (07.01.1999) | MECH | / | / | / | / | / | / | / | / | / | / | / | / |
| 9 | 731616114060 | PRAVEEN R (31.03.1999) | MECH | / | / | / | / | / | / | / | / | / | / | / | / |
| 10 | 731616114061 | PRAVEENKUMAR S | MECH | Intrnship | | | | | | | | | | | |
| 11 | 731616114063 | RAGAVENDHAR S | MECH | / | P | / | / | / | / | / | / | / | / | / | / |
| 12 | 731616114064 | RAHUL C | MECH | / | / | / | / | / | / | / | / | / | / | / | A |
| 13 | 731616114065 | RAJKUMAR S | MECH | / | / | / | / | / | / | / | / | / | / | / | A |
| 14 | 731616114067 | RANJITHKUMAR R | MECH | Intrnship | | | | | | | | | | | |
| 15 | 731616114068 | RANJITH KUMAR V | MECH | / | / | / | / | / | / | / | / | / | / | / | / |
| 16 | 731616114069 | RAVICHANDRAN S | MECH | / | / | / | / | / | / | / | / | / | / | / | / |
| 17 | 731616114070 | RIYAZ AHAMED S | MECH | / | / | / | / | / | / | / | / | / | / | / | P |
| 18 | 731616114071 | RUTHRANNAN B | MECH | / | / | / | / | / | / | / | / | / | / | / | / |
| 19 | 731616114072 | SABARISH R | MECH | / | / | / | / | / | / | / | / | / | / | / | / |
| 20 | 731616114073 | SAKTHIGNANASUNDARAM R H | MECH | / | / | / | / | / | / | / | / | / | / | / | / |
| 21 | 731616114074 | SAKTHIVEL R | MECH | A | A | A | A | / | / | / | / | / | / | / | / |
| 22 | 731616114075 | SANJAY KUMAR S | MECH | / | / | / | / | / | / | / | / | / | / | / | / |
| 23 | 731616114076 | SANJAY KUMAR S K | MECH | / | / | / | / | / | / | / | / | / | / | / | P |
| 24 | 731616114077 | SANTHOSH KUMAR B | MECH | / | / | / | / | / | / | P | P | / | / | / | / |
| 25 | 731616114078 | SANTHOSH KUMAR V | MECH | P | P | P | P | P | P | / | / | / | / | / | / |
| 26 | 731616114079 | SARAN K | MECH | A | A | A | A | / | / | / | / | / | / | / | / |
| 27 | 731616114080 | SARANRAJ S | MECH | / | / | / | / | / | / | / | / | / | / | / | / |
| 28 | 731616114081 | SATHISH G | MECH | / | / | / | / | / | / | / | / | / | / | / | P |
| 29 | 731616114086 | THAMOTHARAN J | MECH | / | / | / | / | / | / | / | / | / | / | P | P |
| 30 | 731616114087 | THIRUMURUGAN V | MECH | / | / | / | / | / | / | / | / | / | / | / | / |

| Date of Training Programme | | | | S.No | | Reg No | | Name | | Branch | | FN | | AN | | FN | | AN | | FN | | AN | | FN | | AN | |
|----------------------------|--------------|-------------------|--------|------------------|----|--------|----|------|----|--------|----|----|----|----|----|----|----|----|----|----|----|----|----|----|----|----|----|
| S. No | Reg No | Name | Branch | FN | AN | FN | AN | FN | AN | FN | AN | FN | AN | FN | AN | FN | AN | FN | AN | FN | AN | FN | AN | FN | AN | FN | AN |
| 31 | 731616114088 | UTHAYAKUMAR M | MECH | / | / | / | / | / | / | / | / | / | / | / | / | / | / | / | / | / | / | / | / | / | / | / | / |
| 32 | 731616114090 | VASANTHAKUMAR P | MECH | / | / | / | / | / | / | / | / | / | / | / | / | / | / | / | / | / | / | / | / | / | / | / | / |
| 33 | 731616114091 | VELMURUGAN T | MECH | / | P | / | / | / | / | / | / | / | / | / | / | / | / | / | / | / | / | / | / | / | / | / | / |
| 34 | 731616114093 | VIGNESH V | MECH | / | / | / | / | / | / | / | / | / | / | / | / | / | / | / | / | / | / | / | / | / | / | / | / |
| 35 | 731616114094 | VIJAY ANAND G | MECH | / | / | / | / | / | / | / | / | / | / | / | / | / | / | / | / | / | / | / | / | / | / | / | / |
| 36 | 731616114095 | VIJAYARAGAVAN P | MECH | / | / | / | / | / | / | / | / | / | / | / | / | / | / | / | / | / | / | / | / | / | / | / | / |
| 37 | 731616114096 | VINOTHMANI M | MECH | / | / | / | / | / | / | / | / | / | / | / | / | / | / | / | / | / | / | / | / | / | / | / | / |
| 38 | 731616114097 | VISHNU A | MECH | Intrnship | | | | | | | | | | | | | | | | | | | | | | | |
| 39 | 731616114099 | YOGARAJ.G | MECH | / | / | / | / | / | / | / | / | / | / | / | / | / | / | / | / | / | / | / | / | / | / | / | / |
| 40 | 731616114100 | YOGESH T | MECH | / | / | / | / | / | / | / | / | / | / | / | / | / | / | / | / | / | / | / | / | / | / | / | A |
| 41 | 731616114310 | SHANMUGAMANIVEL D | MECH | / | / | / | / | / | / | / | / | / | / | / | / | / | / | / | / | / | / | / | / | / | / | / | / |
| 42 | 731616114311 | SURENDHAR J | MECH | / | / | / | / | / | / | / | / | / | / | / | / | / | / | / | / | / | / | / | / | / | / | / | / |
| 43 | 731616114701 | PRANESH.R.K | MECH | / | / | / | / | / | / | / | / | / | / | / | / | / | / | / | / | / | / | / | / | / | / | / | / |
| 44 | 731616114702 | MANOJ.R | MECH | / | / | / | / | / | / | / | / | P | P | P | P | P | P | P | P | P | P | P | P | P | P | P | P |
| PRESENT | | | | 37 | 36 | 38 | 38 | 40 | 40 | 39 | 39 | 40 | 40 | 39 | 39 | 40 | 40 | 39 | 33 | | | | | | | | |
| ABSENT | | | | 2 | 2 | 2 | 2 | 1 | 0 | 0 | 0 | 0 | 0 | 0 | 0 | 0 | 0 | 0 | 3 | | | | | | | | |
| PERMISSION | | | | 5 | 6 | 4 | 4 | 3 | 4 | 5 | 5 | 4 | 4 | 5 | 8 | | | | | | | | | | | | |

PRINCIPAL,
K. S. R. INSTITUTE FOR
ENGINEERING AND TECHNOLOGY,
K. S. R. KAVI NAGAR,
TIRUCHENGOORE - 637 215,
NAMAIGAL DI, TAMIL NADU,

K S R INSTITUTE FOR ENGINEERING AND TECHNOLOGY
DEPARTMENT OF MECHANICAL ENGINEERING
6 DAYS TRAINING TO FINAL YEAR STUDENTS

AGENCY : TALENT TO SUCCESS

DATE : 01.07.2019 - 06.07.2019

| S. No. | Reg. No. | Day 1 | Day 2 | Day 3 | Day 4 | Day 5 | Day 6 | Avg |
|--------------|------------------------|-------|-------|-------|-------|-------|-------|-----|
| 731616114003 | ANNAMALAI K | 26 | 43 | 55 | 57 | 57 | 66 | 51 |
| 731616114004 | ARSHATH S | 26 | | 34 | 57 | 74 | 63 | 51 |
| 731616114005 | ASWINKUMAR S | 22 | 31 | 52 | 50 | 83 | 60 | 50 |
| 731616114007 | BOOPATHI RAJA E | 21 | 23 | 28 | 43 | 83 | 60 | 43 |
| 731616114011 | DEEPAK R | AB | | 48 | 30 | 49 | 46 | 43 |
| 731616114012 | DHAYANIDHI M | AB | | 21 | 27 | 69 | 51 | 42 |
| 731616114013 | DHEVENDRAN E | 14 | 91 | 66 | 43 | 51 | 40 | 51 |
| 731616114015 | DINESH KUMAR C | 16 | 11 | 28 | 30 | 51 | 54 | 32 |
| 731616114017 | GOKULRAJ P | 21 | 34 | | 53 | 83 | 66 | 51 |
| 731616114018 | GOPINATH G | 12 | 26 | 52 | 37 | 49 | 46 | 37 |
| 731616114019 | GOVINDASAMY A | 14 | 26 | 28 | 33 | 51 | 51 | 34 |
| 731616114020 | GOWTHAM P | 15 | 20 | 14 | 10 | 51 | 40 | 25 |
| 731616114021 | GUNASEKARAN R | 17 | 43 | 21 | 33 | 46 | 29 | 32 |
| 731616114022 | HARIHARAN M | 19 | 31 | 52 | 47 | 71 | 77 | 50 |
| 731616114023 | HARIHARAN S | 19 | 31 | 55 | 40 | 74 | 71 | 48 |
| 731616114024 | HARI SHANKAR P | 21 | 57 | 55 | 47 | 83 | 77 | 57 |
| 731616114025 | INBARASAN C | 15 | 57 | 55 | 50 | 89 | 71 | 56 |
| 731616114027 | JAYAMURUGAN K S | 19 | 20 | 66 | 30 | 89 | 57 | 47 |
| 731616114028 | JEEVA K | 19 | 57 | 59 | 47 | 77 | 51 | 52 |
| 731616114029 | JEEVA M | 17 | 51 | 45 | 30 | 77 | 51 | 45 |
| 731616114030 | JESTINRAJ K | 19 | 49 | 31 | 40 | 46 | 54 | 40 |
| 731616114031 | JOSHUA Y | 18 | 31 | 38 | | | | 29 |
| 731616114032 | KALEESWARAN D | 16 | 49 | 17 | 20 | 71 | 40 | 36 |
| 731616114033 | KAROLE INFANTO D | 15 | 34 | 38 | 27 | | 26 | 28 |
| 731616114034 | KARTHIKEYAN P | 10 | 29 | 28 | 33 | 71 | 57 | 38 |
| 731616114035 | KAVIN P | 12 | 31 | 41 | 40 | 86 | 49 | 43 |
| 731616114040 | KIRUBAKARAN M | 19 | 34 | 72 | 33 | 86 | 71 | 53 |
| 731616114041 | LAKSHMI NARAYANAN P | 9 | 20 | 21 | 30 | 69 | 51 | 33 |
| 731616114043 | LOGESH S | 13 | 31 | 14 | 27 | 66 | 43 | 32 |
| 731616114044 | MADHANKUMAR L | 18 | 23 | 38 | 43 | 74 | 66 | 44 |
| 731616114045 | MAGESWARAN A | 15 | 40 | 55 | 33 | 89 | 57 | 48 |
| 731616114046 | MANIKANDAN V | 17 | 20 | 45 | 40 | 63 | 31 | 36 |
| 731616114047 | MANOJKUMAR K | 21 | 11 | 55 | 40 | 86 | 57 | 45 |
| 731616114048 | MOHAMMED NIHAL R | 17 | 71 | 62 | 47 | 89 | 71 | 60 |
| 731616114049 | MOHANAKRISHNAN D | 20 | 40 | 38 | 50 | 83 | 49 | 47 |
| 731616114050 | DHAN ARJUN KUMARAVI | 23 | 43 | 52 | 43 | 80 | 51 | 49 |
| 731616114051 | MOHANRAJ B | 20 | 17 | 45 | 40 | 77 | 60 | 43 |
| 731616114052 | NAMBIRAJ J | 20 | 63 | 77 | 58 | 40 | 79 | 56 |
| 731616114053 | NANDHA GOBAL S | 8 | 20 | 50 | 50 | 37 | 72 | 40 |
| 731616114054 | NAVINKUMAR M | 8 | 29 | 57 | 37 | 37 | 28 | 33 |
| 731616114055 | PARTHASARATHY R | 7 | 17 | 47 | 37 | 40 | 59 | 35 |
| 731616114056 | PRABAKARAN S | 8 | 20 | 63 | 37 | 37 | 69 | 39 |
| 731616114057 | PRABHAKARAN M | 11 | 34 | 57 | 26 | 33 | 48 | 35 |
| 731616114058 | PRASANTH R | 6 | 17 | 63 | 50 | 37 | 76 | 42 |
| 731616114059 | PRAVEEN R (07.01.1999) | 14 | 57 | 63 | 50 | 23 | 24 | 37 |

PRINCIPAL,
**K. S. R. INSTITUTE FOR
ENGINEERING AND TECHNOLOGY,**
K. S. R. KALYANAGAR,
TIRUCHENGODE - 637 215,
NAMAIKAL Dt, TAMIL NADU.

| | | | | | | | | |
|--------------|------------------------|----|----|----|----|----|----|----|
| 731616114060 | PRAVEEN R (31.03.1999) | 11 | 31 | 47 | 34 | 40 | 28 | 32 |
| 731616114061 | PRAVEENKUMAR S | AB | AB | AB | AB | AB | AB | 0 |
| 731616114063 | RAGAVENDHAR S | 8 | 63 | 63 | 53 | 27 | 41 | 43 |
| 731616114064 | RAHUL C | 5 | 49 | 77 | 32 | 40 | 17 | 37 |
| 731616114065 | RAJKUMAR S | 3 | 20 | 47 | 5 | 37 | 34 | 24 |
| 731616114067 | RANJITHKUMAR R | AB | AB | AB | AB | AB | AB | 0 |
| 731616114068 | RANJITH KUMAR V | 12 | 63 | 70 | 55 | 43 | 69 | 52 |
| 731616114069 | RAVICHANDRAN S | 5 | 40 | 87 | 29 | 30 | 41 | 39 |
| 731616114070 | RIYAZ AHAMED S | 3 | 34 | 43 | 18 | 33 | 45 | 29 |
| 731616114071 | RUTHRANNAN B | 8 | 23 | 67 | 34 | 47 | 59 | 40 |
| 731616114072 | SABARISH R | 14 | 80 | 87 | 45 | 40 | 90 | 59 |
| 731616114073 | KT HIGNANASUNDARAM | 14 | 31 | 63 | 34 | 37 | 72 | 42 |
| 731616114074 | SAKTHIVEL R | 11 | | 43 | 34 | 37 | 66 | 38 |
| 731616114075 | SANJAY KUMAR S | 10 | 31 | 77 | 42 | 40 | 83 | 47 |
| 731616114076 | SANJAY KUMAR SK | 13 | 26 | 73 | 39 | 40 | | 38 |
| 731616114077 | SANTHOSH KUMAR B | 6 | 31 | 73 | 0 | 37 | 83 | 38 |
| 731616114078 | SANTHOSH KUMAR V | 0 | 0 | 0 | 39 | 40 | 41 | 20 |
| 731616114079 | SARAN K | 0 | 0 | 40 | 47 | 30 | 69 | 31 |
| 731616114080 | SARANRAJ S | 9 | 46 | 70 | 39 | 40 | 59 | 44 |
| 731616114081 | SATHISH G | 8 | 40 | 60 | 58 | 37 | 62 | 44 |
| 731616114086 | THAMOTHARAN J | 14 | 34 | 73 | 47 | 33 | | 40 |
| 731616114087 | THIRUMURUGAN V | 6 | 17 | 47 | 37 | 37 | 52 | 33 |
| 731616114088 | UTHAYAKUMAR M | 16 | 51 | 50 | 21 | 43 | 62 | 41 |
| 731616114090 | VASANTHAKUMAR P | 12 | 43 | 50 | 21 | 43 | 10 | 30 |
| 731616114091 | VELMURUGAN T | 22 | 46 | 63 | 26 | 30 | 45 | 39 |
| 731616114093 | VIGNESH V | 24 | 80 | 77 | 58 | 43 | 83 | 61 |
| 731616114094 | VIJAY ANAND G | 16 | 63 | 83 | 37 | 37 | 59 | 49 |
| 731616114095 | VIJAYARAGAVAN P | 18 | 46 | 57 | 53 | 40 | 45 | 43 |
| 731616114096 | VINOTHMANI M | 23 | 86 | 83 | 47 | 47 | 83 | 62 |
| 731616114097 | VISHNU A | AB | AB | AB | AB | AB | AB | 0 |
| 731616114099 | YOGARAJ.G | 16 | 37 | 43 | 45 | 43 | 59 | 41 |
| 731616114100 | YOGESH T | 9 | 34 | 53 | 39 | 30 | 31 | 33 |
| 731616114302 | BALAJI M | 21 | 14 | 45 | 40 | 86 | 57 | 44 |
| 731616114305 | JEEVANANDHAM N | 9 | 26 | 28 | 33 | 83 | 46 | 38 |
| 731616114306 | KARTHI S | 10 | 17 | 31 | 37 | 83 | 54 | 39 |
| 731616114308 | PRASANTH S | 12 | 29 | 45 | 40 | 89 | 60 | 46 |
| 731616114310 | SHANMUGAMANIVEL D | 15 | 54 | 73 | 50 | 37 | 76 | 51 |
| 731616114311 | SURENDHAR J | 8 | 31 | 77 | 55 | 37 | 76 | 47 |
| 731616114701 | PRANESH.S.K | 4 | 14 | 50 | 32 | 33 | 62 | 33 |
| 731616114702 | MANOJ.R | 16 | 57 | 83 | | | | 52 |

| Day 1 | Day 2 | Day 3 | Day 4 | Day 5 | Day 6 |
|-------|-------|-------|-------|-------|-------|
| V | A | A | V | R | Q |
| A | A | V | R | Q | Q |

A. Umam
Department
Coordinator

Place: K. S. Nagar,

PRINCIPAL,
K. S. N. INSTITUTE FOR
ENGINEERING AND TECHNOLOGY,
K. S. N. ROAD, K. S. NAGAR,
TIRUCHENAI - 627 215,
NAMAKKAL DISTRICT, TAMIL NADU.

HOD/mech

**K S R INSTITUTE FOR ENGINEERING AND TECHNOLOGY
TIRUCHENGODE - 637 215**

TRAINING PROGRAMME FEEDBACK FORM



Name of the Student: K. Annamalai

Branch: B.E. Mech - IV Yr.

Year / Sem: IV - VII sem

1. Name of the Training: Verbal Ability

2. Name of the Trainer: Sindhu mam

3. Students rating of Trainers: 4.5 out of 5

| S. No. | Date | Subject | Rating (✓) | | | |
|--------|-----------------------|----------------|------------|-----------|------|---------|
| | | | Excellent | Very good | Good | Average |
| 1 | 01.07.19 (Morning) | verbal Ability | ✓ | | | |

4. Two positive points about the programme: Good and Interactive.
more useful regarding english

5. Suggestions for improvement: language

Date: 01/7/19

[Signature]
Signature

**K S R INSTITUTE FOR ENGINEERING AND TECHNOLOGY
TIRUCHENGODE - 637 215**

TRAINING PROGRAMME FEEDBACK FORM



Name of the Student: Mohan Arjun Kumaravel

Branch: Mechanical

Year / Sem: IV - VII sem

1. Name of the Training: Verbal Ability

2. Name of the Trainer: Sindhu mam

3. Students rating of Trainers:

| S. No. | Date | Subject | Rating (✓) | | | |
|--------|----------|----------------|------------|-----------|------|---------|
| | | | Excellent | Very good | Good | Average |
| 1 | 01.07.19 | verbal Ability | ✓ | | | |

4. Two positive points about the programme: Learned a lot of new words and a few meaningful words.

5. Suggestions for improvement:

Date: 01-07-2019

[Signature]
Signature

K. S. R. INSTITUTE FOR ENGINEERING AND TECHNOLOGY,
TIRUCHENGODE - 637 215,
NAMAKKAL DISTRICT, TAMIL NADU.

**K S R INSTITUTE FOR ENGINEERING AND TECHNOLOGY
TIRUCHENGODE - 637 215**

TRAINING PROGRAMME FEEDBACK FORM



Name of the Student: E. Dheerendran

Branch: Final yr mech - A

Year / Sem: IV / VII

1. Name of the Training : Verbal Ability

2. Name of the Trainer : Sindhu

3. Students rating of Trainers :

| S. No. | Date | Subject | Rating (√) | | | |
|--------|------------|----------------|------------|-----------|------|---------|
| | | | Excellent | Very good | Good | Average |
| 1 | 01/07/2019 | verbal ability | ✓ | | | |

4. Two positive points about the programme:

1. clearly explanation of the circumstances

2. Learn to the verbs of the sentence format

5. Suggestions for improvement:

Date: 01/07/2019

Dheerendran
Signature

**K S R INSTITUTE FOR ENGINEERING AND TECHNOLOGY
TIRUCHENGODE - 637 215**

TRAINING PROGRAMME FEEDBACK FORM



Name of the Student: K. Jestin Raj.

Branch: Mechanical

Year / Sem: IV / VII

1. Name of the Training : Verbal Ability

2. Name of the Trainer : B. Sindhu

3. Students rating of Trainers :

| S. No. | Date | Subject | Rating (√) | | | |
|--------|----------|----------------|------------|-----------|------|---------|
| | | | Excellent | Very good | Good | Average |
| 1 | 01/07/19 | Verbal ability | | Very good | | |

4. Two positive points about the programme:

1) Teaching quality is excellent 2) learning some verbals, and

5. Suggestions for improvement:

ENGINEERING TECHNOLOGY,
Synonyms & antonyms.

Date: 01/07/2019

K. Jestin Raj
Signature
TIRUCHENGODE - 637 215,
NAMAKKAL DISTRICT, TAMIL NADU.

K S R INSTITUTE FOR ENGINEERING AND TECHNOLOGY
TIRUCHENGODE - 637 215

TRAINING PROGRAMME FEEDBACK FORM



Name of the Student: M. VINOTHMANI

Branch: Mechanical

Year / Sem: IV / VII

1. Name of the Training : Aptitude

2. Name of the Trainer : R. Boopathi Raja

3. Students rating of Trainers :

| S. No. | Date | Subject | Rating (√) | | | |
|--------|--------|-----------|------------|-----------|------|---------|
| | | | Excellent | Very good | Good | Average |
| 1 | 1.7.19 | Placement | ✓ | | | |

4. Two positive points about the programme: * faster in calculation; shortcut methods.

* student should do their calculation

5. Suggestions for improvement: - by own.

Date: 1.7.19

M. Vinodhmani
Signature

K S R INSTITUTE FOR ENGINEERING AND TECHNOLOGY
TIRUCHENGODE - 637 215

TRAINING PROGRAMME FEEDBACK FORM



Name of the Student: R. PRAVEEN

Branch: Mechanical

Year / Sem: IV / VII

1. Name of the Training : Aptitude

2. Name of the Trainer : R. Boopathi Raja

3. Students rating of Trainers :

| S. No. | Date | Subject | Rating (√) | | | |
|--------|--------|-----------|------------|-----------|------|---------|
| | | | Excellent | Very good | Good | Average |
| 1 | 1.7.19 | Placement | ✓ | | | |

4. Two positive points about the programme: * Easy way of learning Aptitude

5. Suggestions for improvement: -

EMON useful class

Date: 1.7.19.

TIRUCHENGODE - 637 215
NAMAKKAL DISTRICT, TAMIL NADU.

R. Praveen
Signature

**K S R INSTITUTE FOR ENGINEERING AND TECHNOLOGY
TIRUCHENGODE - 637 215**

TRAINING PROGRAMME FEEDBACK FORM



Name of the Student: E. Dhewendran

Branch: Mechanical

Year / Sem: IV / VII

1. Name of the Training : Artitude
2. Name of the Trainer : Boobathiraja
3. Students rating of Trainers :

| S. No. | Date | Subject | Rating (✓) | | | |
|--------|---------|---|------------|-----------|------|---------|
| | | | Excellent | Very good | Good | Average |
| 1 | 2/07/19 | percentage simple and compound interest | ✓ | | | |

4. Two positive points about the programme:
 - * well taught.
 - * clear explanation
5. Suggestions for improvement:
 - * simple trick to solve problem

Date: 2/07/19

E. Dhewendran
Signature

**K S R INSTITUTE FOR ENGINEERING AND TECHNOLOGY
TIRUCHENGODE - 637 215**

TRAINING PROGRAMME FEEDBACK FORM



Name of the Student: Y. Joshua

Branch: Mechanical

Year / Sem: IV / VII

1. Name of the Training : Artitude
2. Name of the Trainer : Boopathiraja
3. Students rating of Trainers :

| S. No. | Date | Subject | Rating (✓) | | | |
|--------|---------|---|------------|-----------|------|---------|
| | | | Excellent | Very good | Good | Average |
| 1 | 2/07/19 | percentage simple and compound interest | | ✓ | | |

4. Two positive points about the programme:
 - * Short cuts for sums
 - * explanation
5. Suggestions for improvement:
 - Need more short cut tricks to solve problem

Date: 2/07/19

Y. Joshua
Signature

**K S R INSTITUTE FOR ENGINEERING AND TECHNOLOGY
TIRUCHENGODE - 637 215**

TRAINING PROGRAMME FEEDBACK FORM



Name of the Student: M. Balaji

Branch: Mechanical

Year / Sem: IV / VII

1. Name of the Training: ARRIHULO
2. Name of the Trainer: ROOPATHY RAJA. R
3. Students rating of Trainers: 4.5 / 5

| S. No. | Date | Subject | Rating (✓) | | | |
|--------|--------|--------------------------|------------|-----------|------|---------|
| | | | Excellent | Very good | Good | Average |
| 1 | 2/7/19 | Profit 10% Percentage | ✓ | | | |

4. Two positive points about the programme: to improve the profit 10% and percentage

5. Suggestions for improvement: It will use for placement

Date: 2/7/19

M. Balaji
Signature

**K S R INSTITUTE FOR ENGINEERING AND TECHNOLOGY
TIRUCHENGODE - 637 215**

TRAINING PROGRAMME FEEDBACK FORM



Name of the Student: M. JEEVA

Branch: Mechanical

Year / Sem: IV / VII

1. Name of the Training: ROOPATHY RAJA. R
2. Name of the Trainer: ARRIHULO
3. Students rating of Trainers :

| S. No. | Date | Subject | Rating (✓) | | | |
|--------|--------|--------------------------|------------|-----------|------|---------|
| | | | Excellent | Very good | Good | Average |
| 1 | 2/7/19 | Profit 10% Percentage | ✓ | | | |

4. Two positive points about the programme: to learn about Profit 10% and the percentage

5. Suggestions for improvement: It will use for placement.

Date: 2/7/19

Principal
M. Jeeva
Signature
K. S. R. INSTITUTE FOR
ENGINEERING AND TECHNOLOGY
TIRUCHENGODE - 637 215,
NAMAKKAL Dt, TAMIL NADU.

K S R INSTITUTE FOR ENGINEERING AND TECHNOLOGY
TIRUCHENGODE - 637 215

TRAINING PROGRAMME FEEDBACK FORM



Name of the Student: Elayarajou K.S.

Branch: Mechanical Engg

Year / Sem: IV / VII

1. Name of the Training: APPHITUDE

2. Name of the Trainer: preethi

3. Students rating of Trainers: 1

| S. No. | Date | Subject | Rating (√) | | | |
|--------|----------|---------------|------------|-----------|------|---------|
| | | | Excellent | Very good | Good | Average |
| 1 | 03/07/19 | Time and work | ✓ | | | |

4. Two positive points about the programme:

* Solving the Problem using shortcuts.

* Know about use of learning aptitude.

5. Suggestions for improvement:

Nil.

Date: 03/07/19

[Signature]
Signature

K S R INSTITUTE FOR ENGINEERING AND TECHNOLOGY
TIRUCHENGODE - 637 215

TRAINING PROGRAMME FEEDBACK FORM



Name of the Student: Gunasakaran R

Branch: Mechanical Engg

Year / Sem: IV / VII

1. Name of the Training: APPHITUDE

2. Name of the Trainer: preethi

3. Students rating of Trainers: 1

| S. No. | Date | Subject | Rating (√) | | | |
|--------|--------------|---------------|------------|-----------|------|---------|
| | | | Excellent | Very good | Good | Average |
| 1 | 3.7.19 FN | Time and work | | ✓ | | |

4. Two positive points about the programme:

* Solving difficult problem in shortcut and variety problem

5. Suggestions for improvement:

* use of aptitude in RRB Bank exam

Date: 3.7.19

Nil

[Signature]
Signature
K. S. R. INSTITUTE FOR
ENGINEERING AND TECHNOLOGY,
K. S. R. INSTITUTE FOR
TIRUCHENGODE - 637 215,
NAMAKKAL Dt, TAMIL NADU.

**K S R INSTITUTE FOR ENGINEERING AND TECHNOLOGY
TIRUCHENGODE - 637 215**

TRAINING PROGRAMME FEEDBACK FORM



Name of the Student: Inbatrasan.C

Branch: Mech - B

Year / Sem: IV / VII

1. Name of the Training: Aptitude

2. Name of the Trainer: Manoj

3. Students rating of Trainers: 2 out of 10.

| S. No. | Date | Subject | Rating (√) | | | |
|--------|--------------|---|------------|-----------|------|---------|
| | | | Excellent | Very good | Good | Average |
| 1 | 3-7-19 AN | Time and work Speed & distance Average. | √ | | | |

4. Two positive points about the programme:

1. Teaching is good.
2. Doubt clarification is good.

5. Suggestions for improvement:

Date: 3-7-19.

C. Anby
Signature

**K S R INSTITUTE FOR ENGINEERING AND TECHNOLOGY
TIRUCHENGODE - 637 215**

TRAINING PROGRAMME FEEDBACK FORM



Name of the Student: R. LAKSHMI NARAYANAN

Branch: MECH - A

Year / Sem: IV / VII

1. Name of the Training: Aptitude

2. Name of the Trainer: Manoj

3. Students rating of Trainers: 9 out of 10

| S. No. | Date | Subject | Rating (√) | | | |
|--------|--------|--|------------|-----------|------|---------|
| | | | Excellent | Very good | Good | Average |
| 1 | 3-7-19 | Time of work. Speed of Distance Average. | √ | √ | | |

4. Two positive points about the programme:

- easy method to multiply. by solving Problems

5. Suggestions for improvement:

Date: 3-7-19

[Signature]
Signature

**K S R INSTITUTE FOR ENGINEERING AND TECHNOLOGY
TIRUCHENGODE - 637 215**

TRAINING PROGRAMME FEEDBACK FORM



Name of the Student: K. Annamalai

Branch: Mechanical

Year / Sem: IV / 07

1. Name of the Training : Reasoning Ability

2. Name of the Trainer : SINDHU

3. Students rating of Trainers : 4.5/5

| S. No. | Date | Subject | Rating (√) | | | |
|--------|--------|--------------------------|------------|-----------|------|---------|
| | | | Excellent | Very good | Good | Average |
| 1 | 4-7-19 | Numbers & Blood Relation | ✓ | | | |

4. Two positive points about the programme: Interaction is good
more interesting to solve problems

5. Suggestions for improvement: —

Date: 4/7/19

[Signature]
Signature

**K S R INSTITUTE FOR ENGINEERING AND TECHNOLOGY
TIRUCHENGODE - 637 215**

TRAINING PROGRAMME FEEDBACK FORM



Name of the Student: C. Dinush Kumar

Branch: MECHANICAL

Year / Sem: IV / 07

1. Name of the Training : Reasoning

2. Name of the Trainer : SINDHU

3. Students rating of Trainers : 4.5/5

| S. No. | Date | Subject | Rating (√) | | | |
|--------|---------|--------------------------|------------|-----------|------|---------|
| | | | Excellent | Very good | Good | Average |
| 1 | 4/07/19 | Numbers & Blood Relation | ✓ | | | |

4. Two positive points about the programme: Good interaction, Good communication in english

5. Suggestions for improvement: NO

Date: 4/7/19

PRINCIPAL
K. S. R. INSTITUTE FOR
ENGINEERING AND TECHNOLOGY,
TIRUCHENGODE - 637 215,
NAMAKKAL DISTRICT, TAMIL NADU.
[Signature]
 Signature

**K S R INSTITUTE FOR ENGINEERING AND TECHNOLOGY
TIRUCHENGODE - 637 215**

TRAINING PROGRAMME FEEDBACK FORM



Name of the Student: Magesthwaran

Branch: Mechanical

Year / Sem: IV / VII

1. Name of the Training : Reasoning ability

2. Name of the Trainer : Sindhu

3. Students rating of Trainers : 4/5

| S. No. | Date | Subject | Rating (√) | | | |
|--------|----------|--------------------------------|------------|-----------|------|---------|
| | | | Excellent | Very good | Good | Average |
| 1 | 4-7-2019 | Analogy direction coding | | | ✓ | |

4. Two positive points about the programme:

Easy listening
very useful

5. Suggestions for improvement:

Date: 4-7-2019

[Signature]
Signature

**K S R INSTITUTE FOR ENGINEERING AND TECHNOLOGY
TIRUCHENGODE - 637 215**

TRAINING PROGRAMME FEEDBACK FORM



Name of the Student: K. Manoj Kumar

Branch: Mechanical

Year / Sem: IV / VII

1. Name of the Training : Reasoning Ability

2. Name of the Trainer : Sindhu

3. Students rating of Trainers : 4/5

| S. No. | Date | Subject | Rating (√) | | | |
|--------|----------|--------------------------------|------------|-----------|------|---------|
| | | | Excellent | Very good | Good | Average |
| 1 | 4-7-2019 | Analogy direction coding | | | ✓ | |

4. Two positive points about the programme:

developing
improved

5. Suggestions for improvement:

Date: 4-7-2019

PRINCIPAL,
K. S. R. INSTITUTE FOR
ENGINEERING AND TECHNOLOGY,
K. S. R. KALYANAGAR,
TIRUCHENGODE - 637 215,
NAMAKKAL Dt, TAMIL NADU.
[Signature]
Signature

K S R INSTITUTE FOR ENGINEERING AND TECHNOLOGY
TIRUCHENGODE - 637 215

TRAINING PROGRAMME FEEDBACK FORM



Name of the Student: JEEVA . K

Branch: Mech

Year / Sem: IV / 07

1. Name of the Training : APTITUDE

2. Name of the Trainer : PRA THISH

3. Students rating of Trainers : 5/5

| S. No. | Date | Subject | Rating (✓) | | | |
|--------|----------|------------------------------------|------------|-----------|------|---------|
| | | | Excellent | Very good | Good | Average |
| 1 | 05/07/19 | Partnership Prime factorization | ✓ | | | |

4. Two positive points about the programme:

Easy way to solving problem
Good teaching

5. Suggestions for improvement:

Date: 5/7/19

J. Jeeva
Signature

K S R INSTITUTE FOR ENGINEERING AND TECHNOLOGY
TIRUCHENGODE - 637 215

TRAINING PROGRAMME FEEDBACK FORM



Name of the Student: Dhayanidhi . M

Branch: Mech

Year / Sem: IV / 7

1. Name of the Training : Aptitude

2. Name of the Trainer : Prathish

3. Students rating of Trainers : 5/5

| S. No. | Date | Subject | Rating (✓) | | | |
|--------|--------|------------------------------------|------------|-----------|------|---------|
| | | | Excellent | Very good | Good | Average |
| 1 | 5/7/19 | Partnership Prime factorization | ✓ | ✓ | | |

4. Two positive points about the programme:

Very useful to start beginning concept

5. Suggestions for improvement:

Date: 5-7-19

M. D. L.
Signature

PRINCIPAL,
K. S. R. INSTITUTE FOR
ENGINEERING AND TECHNOLOGY,
TIRUCHENGODE - 637 215,
MADRAS STATE, TAMIL NADU.

**K S R INSTITUTE FOR ENGINEERING AND TECHNOLOGY
TIRUCHENGODE - 637 215**

TRAINING PROGRAMME FEEDBACK FORM



Name of the Student: M. Kishan Kanan

Branch: Mech

Year / Sem: V / VII

1. Name of the Training: Aptitude

2. Name of the Trainer: Prathish

3. Students rating of Trainers: 4.5/5

| S. No. | Date | Subject | Rating (√) | | | |
|--------|--------|----------------------|------------|-----------|------|---------|
| | | | Excellent | Very good | Good | Average |
| 1 | 5.7.19 | Average, units Ratio | | ✓ | | |

4. Two positive points about the programme:

Short cut methods for solving problem
Guidance for competitive Exams

5. Suggestions for improvement:

Date: 5.7.19

M. Anil
Signature

**K S R INSTITUTE FOR ENGINEERING AND TECHNOLOGY
TIRUCHENGODE - 637 215**

TRAINING PROGRAMME FEEDBACK FORM



Name of the Student: S. Anshath

Branch: Mech

Year / Sem: V / VII

1. Name of the Training: aptitude

2. Name of the Trainer: Prathish

3. Students rating of Trainers: 4

| S. No. | Date | Subject | Rating (√) | | | |
|--------|--------|---------------------|------------|-----------|------|---------|
| | | | Excellent | Very good | Good | Average |
| 1 | 5.7.19 | Average units Ratio | | ✓ | | |

4. Two positive points about the programme:

Technical solving problem
Understand each & every part with oblige

5. Suggestions for improvement:

Date: 5.7.19

S. Anshath
Signature

K S R INSTITUTE FOR ENGINEERING AND TECHNOLOGY
TIRUCHENGODE - 637 215

TRAINING PROGRAMME FEEDBACK FORM



Name of the Student: R. prasanth

Branch: Mechanical

Year / Sem: V / VI

1. Name of the Training : Reasoning

2. Name of the Trainer : Suganya

3. Students rating of Trainers : 8/10

| S. No. | Date | Subject | Rating (✓) | | | |
|--------|--------|-----------|------------|-----------|------|---------|
| | | | Excellent | Very good | Good | Average |
| 1 | 5/7/19 | Reasoning | ✓ | | | |

4. Two positive points about the programme:

Easy to learn

5. Suggestions for improvement: More interaction may required

Date: 5/7/19

R. Prasad
Signature

K S R INSTITUTE FOR ENGINEERING AND TECHNOLOGY
TIRUCHENGODE - 637 215

TRAINING PROGRAMME FEEDBACK FORM



Name of the Student: P. H. Sakthi Gnana Sundaram Branch: Mechanical

Year / Sem: V / VI

1. Name of the Training : Suganya Reasoning

2. Name of the Trainer : Suganya

3. Students rating of Trainers : 8/10

| S. No. | Date | Subject | Rating (✓) | | | |
|--------|--------|-----------|------------|-----------|------|---------|
| | | | Excellent | Very good | Good | Average |
| 1 | 5.7.19 | Reasoning | ✓ | ✓ | | |

4. Two positive points about the programme: Good understanding, Easy shortcuts

5. Suggestions for improvement: No improvement needed

Date: 05.07.19

P. H. Sakthi Gnana Sundaram
Signature

**K S R INSTITUTE FOR ENGINEERING AND TECHNOLOGY
TIRUCHENGODE - 637 215**

TRAINING PROGRAMME FEEDBACK FORM



Name of the Student: C. Rahul

Branch: Mech

Year / Sem: V / VII

1. Name of the Training: Reasoning

2. Name of the Trainer: Suganya

3. Students rating of Trainers :

| S. No. | Date | Subject | Rating (✓) | | | |
|--------|--------|--------------------|------------|-----------|------|---------|
| | | | Excellent | Very good | Good | Average |
| 1 | 5/7/19 | coding & decoding, | ✓ | | | |

4. Two positive points about the programme: * learned several new things
* got new idea for exam.

5. Suggestions for improvement: * Can provide question bank for solving.

Date: 5.7.19

C. Rahul
Signature

**K S R INSTITUTE FOR ENGINEERING AND TECHNOLOGY
TIRUCHENGODE - 637 215**

TRAINING PROGRAMME FEEDBACK FORM



Name of the Student: S. Vandhagobal

Branch: MECH

Year / Sem: IV / VII

1. Name of the Training: Reasoning

2. Name of the Trainer: Suganya

3. Students rating of Trainers :

| S. No. | Date | Subject | Rating (✓) | | | |
|--------|--------|-----------|------------|-----------|------|---------|
| | | | Excellent | Very good | Good | Average |
| 1 | 5.7.19 | Reasoning | ✓ | | | |

4. Two positive points about the programme: * Easy to understand to solve the problem's
* Quick to solve the problem.

5. Suggestions for improvement: Easy to solve the big problem
in quick way

Date: 5.7.19

S. Vandhagobal
Signature

**K S R INSTITUTE FOR ENGINEERING AND TECHNOLOGY
TIRUCHENGODE - 637 215**

TRAINING PROGRAMME FEEDBACK FORM



Name of the Student: S. SANKAR KUMAR

Branch: Mechanical

Year / Sem: IV / VII

1. Name of the Training: Placement training

2. Name of the Trainer: BOOPATHI RAJA

3. Students rating of Trainers :

| S. No. | Date | Subject | Rating (✓) | | | |
|--------|----------|------------------------------|------------|-----------|------|---------|
| | | | Excellent | Very good | Good | Average |
| 1 | 06.07.19 | Aptitude (Time, distance) | | ✓ | | |

4. Two positive points about the programme: Easy to learn

5. Suggestions for improvement: Need lot of shortcuts

Date: 06.07.19

S. Sankar
Signature

**K S R INSTITUTE FOR ENGINEERING AND TECHNOLOGY
TIRUCHENGODE - 637 215**

TRAINING PROGRAMME FEEDBACK FORM



Name of the Student: P. Sakthivel

Branch: Mechanical

Year / Sem: IV / VII

1. Name of the Training: Placement training

2. Name of the Trainer: Boopathi Raja

3. Students rating of Trainers :

| S. No. | Date | Subject | Rating (✓) | | | |
|--------|----------|------------------------------|------------|-----------|------|---------|
| | | | Excellent | Very good | Good | Average |
| 1 | 06.07.19 | Aptitude (Time, distance) | ✓ | | ✓ | |

4. Two positive points about the programme: 1. Increase knowledge

2. Easily understanding

5. Suggestions for improvement:

more of shortcuts tips improved.

Date: 6.7.19

P. Sakthivel
Signature

**K S R INSTITUTE FOR ENGINEERING AND TECHNOLOGY
TIRUCHENGODE - 637 215**

TRAINING PROGRAMME FEEDBACK FORM



Name of the Student: TESTINRAJ.R Branch: MECHANICAL

Year / Sem: IV / VII

1. Name of the Training: Permutation, combination, probability and Data Interpretation

2. Name of the Trainer: Hiridhanan

3. Students rating of Trainers :

| S. No. | Date | Subject | Rating (✓) | | | |
|--------|------------|---------|------------|-----------|------|---------|
| | | | Excellent | Very good | Good | Average |
| 1 | 06/07/2019 | | | ✓ | | |

4. Two positive points about the programme:

1. He taught with many examples. so, we can easily understand.
2. Teaching method is easy to understand.

5. Suggestions for improvement:

1. we want more examples.

Date: 06/07/19

H. Jey
Signature

**K S R INSTITUTE FOR ENGINEERING AND TECHNOLOGY
TIRUCHENGODE - 637 215**

TRAINING PROGRAMME FEEDBACK FORM



Name of the Student: R. Deepak Branch: Mech 'A'

Year / Sem: IV / VII

1. Name of the Training: Permutation, combination probability & Data Interpretation

2. Name of the Trainer: Hiridhanan

3. Students rating of Trainers :

| S. No. | Date | Subject | Rating (✓) | | | |
|--------|------------|---------|------------|-----------|------|---------|
| | | | Excellent | Very good | Good | Average |
| 1 | 06/07/2019 | | | | ✓ | |

4. Two positive points about the programme:

Delivery of Problem is easy

5. Suggestions for improvement:

Understand the approach of student is good

Date: 06/07/19

It will solve some more problem
R. Deepak
Signature

**K S R INSTITUTE FOR ENGINEERING AND TECHNOLOGY
TIRUCHENGODE - 637 215**

TRAINING PROGRAMME FEEDBACK FORM



Name of the Student: R. LAKSHMI NARAYANAN

Branch: MECHANICAL

Year / Sem: IV / VII

1. Name of the Training: APTITUDE

2. Name of the Trainer: GIRIDHARAN

3. Students rating of Trainers: 7/10

| S. No. | Date | Subject | Rating (√) | | | |
|--------|-----------|---|------------|-----------|------|---------|
| | | | Excellent | Very good | Good | Average |
| 1 | 6/07/2019 | PERMUTATION, COMBINATIONS & PROBABILITY | ✓ | | | |

4. Two positive points about the programme: *EASY METHODS
* SOLVE THE PROBLEMS IN SHORT CUTS

5. Suggestions for improvement: _____

Date: 06/07/2019

Signature

**K S R INSTITUTE FOR ENGINEERING AND TECHNOLOGY
TIRUCHENGODE - 637 215**

TRAINING PROGRAMME FEEDBACK FORM



Name of the Student: M. Jeeva

Branch: Mechanical

Year / Sem: IV / VII

1. Name of the Training: APTITUDE

2. Name of the Trainer: GIRIDHARAN

3. Students rating of Trainers: 6/10

| S. No. | Date | Subject | Rating (√) | | | |
|--------|--------|-------------------------------|------------|-----------|------|---------|
| | | | Excellent | Very good | Good | Average |
| 1 | 6/7/19 | PERMUTATIONS & PROBABILITY | ✓ | | | |

4. Two positive points about the programme: Solve the problems in an easy method in short form. Learn about probability.

5. Suggestions for improvement: _____

Date: 06/07/19

Signature

Ref: KSRIET/T&P/CIR/2019-20

Date: 29.06.2019

This is to inform that all the HoD's, Faculty members and Training & Placement coordinators that External Aptitude Training programme for III & IV year Mechanical students by Talent 2 Success & III year CSE, ECE,EEE & IT students by FACE for the academic year 2019 - 2020 (Odd Sem) is scheduled as given below. All the registered students should attend the Training Programme without fail. If any student skips this Training Programme he / she will not be permitted for any further Training Programme and campus recruitment process. Proper Dress Code is mandatory.

| S.No | Dates | Branch | Students | Venue | Assessment Venue |
|------|--------------------------------|--|--|---|---|
| 1 | 01.07.2019 To 06.07.2019 | MECH (IV Year) by T2S | MECH - 85 | Batch 1 - MIC 202 Batch 2 - MIC 204 | Batch 1 - CAD Lab Batch 2 - Virtusa Lab |
| 2 | | CSE, ECE, EEE & IT (III Year) by FACE | CSE - 36 ECE - 72, EEE - 43 IT - 34 | Batch 1 - M 106 Batch 2 - M 108 Batch 3 - M 109 | Batch1 - CSE Lab Batch2 - IT Lab Batch3 - ECE Lab |
| 3 | 22.7.2019 To 27.7.2019 | MECH (III Year) by T2S | MECH - 65 | MECH Block | CAD Lab |

Y. Kalvi
T&P OFFICER

[Signature]
T&P COORDINATOR

[Signature]
PRINCIPAL

Copy to:

1. All HoDs
2. Notice Board.

Session Timings:

Forenoon Session: 09.00 AM to 12.30 PM Break: 10.45 AM to 11.00 AM & 3.00PM - 03.15PM

Afternoon Session: 01.30 PM to 04.45 PM Lunch: 12.30 PM to 01.30 PM

Assessments Session: 05.15 PM - 06.40 PM

[Signature]
PRINCIPAL,
K. S. R. INSTITUTE FOR
ENGINEERING AND TECHNOLOGY,
K. S. R. KALVI NAGAR,
TIRUCHENGODE - 637 215,
NAMAKKAL Dt, TAMIL NADU.

K S R INSTITUTE FOR ENGINEERING AND TECHNOLOGY

TRAINING AND PLACEMENT CELL

III Year Face Training [01.07.2019 - 06.07.2019]

| Session Duration | Topic |
|-------------------------|--|
| 3 | Numbers system |
| 3 | Reading comprehension |
| 3 | Data arrangements and Blood relations |
| 3 | Time and work |
| 3 | Sentence correction |
| 3 | Coding & decoding, Series, Analogy, Odd man out and Visual reasoning |
| 3 | Percentages, Simple interest and Compound interest |
| 3 | Sentence completion and Para-jumbles |
| 3 | Clocks, calendars, Direction sense and Cubes |
| 3 | Time, Speed and Distance |
| 3 | Vocabulary |
| 3 | Data interpretation and Data sufficiency |

1, 3, 5 July - 131515-Indumathy S*, 132997 Ria Susan John, 132996 Archana Sajan

2, 4, 6 July - 134004 Nima Joshy, 132999 Stephin Tenzeen

2 Jul - 132605-Arun M*

4, 6 July - 132869-Prasad C*

PRINCIPAL,
K. S. R. INSTITUTE FOR
ENGINEERING AND TECHNOLOGY,
K. S. R. KALVI NAGAR,
TIRUCHENGODE - 637 215,
NAMAKKAL Dt, TAMIL NADU.

Training and Placement Cell

Batch 1 - Face Aptitude Training Attendance (Odd Semester)

| BATCH : 2016 - 2020 | | Incharge: EEE | | Hall No: 106 | | | | Academic Year: 2019 - 2020 | | | | | | | |
|----------------------------|--------------|-------------------------|--------|--------------|----|----------|----|----------------------------|----|----------|----|----------|----|----------|----|
| Date of Training Programme | | | | 01.07.19 | | 02.07.19 | | 03.07.19 | | 04.07.19 | | 05.07.19 | | 06.07.19 | |
| S. No | Reg No | Name | Branch | FN | AN | FN | AN | FN | AN | FN | AN | FN | AN | FN | AN |
| 1 | 731617105001 | ARUL M | EEE | / | / | / | / | / | / | / | / | / | / | / | / |
| 2 | 731617105002 | ASHA R | EEE | / | / | / | / | / | / | / | / | / | / | / | / |
| 3 | 731617105003 | BALAJI S | EEE | / | / | / | / | / | / | / | / | / | / | / | / |
| 4 | 731617105004 | BHARATH S | EEE | / | / | / | / | / | / | / | / | P | P | A | A |
| 5 | 731617105005 | DINESH C | EEE | / | / | / | / | / | / | / | / | / | / | / | / |
| 6 | 731617105008 | GOWTHAM S P | EEE | / | / | / | / | / | / | / | / | / | / | / | / |
| 7 | 731617105009 | GUGANESH R | EEE | / | / | / | / | / | / | / | / | / | / | / | / |
| 8 | 731617105010 | HARI S R | EEE | / | / | / | / | / | / | / | / | / | / | / | / |
| | 731617105012 | JAYASURYA K | EEE | A | A | / | / | / | / | / | / | / | / | / | / |
| 10 | 731617105013 | JEEVANANDAM T | EEE | / | / | / | / | / | / | / | / | / | / | / | / |
| 11 | 731617105014 | JEEVITHA G | EEE | / | / | / | / | / | / | / | / | / | / | / | / |
| 12 | 731617105016 | KAMALAHASAN G | EEE | / | / | / | / | / | / | / | / | / | / | / | / |
| 13 | 731617105017 | KARTHIKEYAN M | EEE | / | / | / | / | / | / | / | / | / | / | / | / |
| 14 | 731617105018 | KAVINKUMAR M | EEE | / | / | / | / | / | / | / | / | / | / | / | / |
| 15 | 731617105019 | KAVIN MUTHU KUMAR S | EEE | / | / | / | / | / | / | / | / | / | / | / | / |
| 16 | 731617105020 | KIRUBAKAR S | EEE | / | / | / | / | / | / | / | / | / | / | / | / |
| 17 | 731617105021 | LOGESWARAN C | EEE | / | / | / | / | / | / | / | / | / | / | / | / |
| 18 | 731617105022 | MANJUPRIYA M | EEE | / | / | / | / | / | / | / | / | / | / | / | / |
| 19 | 731617105023 | MANOJ KUMAR S | EEE | / | / | / | / | / | / | / | / | / | / | / | / |
| ... | 731617105024 | MOHAN T | EEE | / | / | / | / | / | / | / | / | / | / | / | / |
| 21 | 731617105025 | NANDAKUMAARAN S | EEE | / | / | / | / | / | / | / | / | / | / | / | / |
| 22 | 731617105027 | PARAMASIVAM R | EEE | / | / | / | / | / | / | / | / | / | / | P | P |
| 23 | 731617105028 | PERARIVU EZHIL ARASAN T | EEE | / | / | / | / | / | / | / | / | / | / | / | / |
| 24 | 731617105031 | PRAVEEN KUMAR A | EEE | A | A | / | / | / | / | / | / | / | / | / | / |
| 25 | 731617105032 | PRAVEEN KUMAR M | EEE | / | / | / | / | / | / | / | / | / | / | / | / |
| 26 | 731617105033 | RAJAT KUMAR | EEE | / | / | / | / | / | / | / | / | / | / | / | / |
| 27 | 731617105035 | RAMYA P | EEE | / | / | / | / | / | / | / | / | / | / | / | / |
| 28 | 731617105036 | SAKTHIVEL P | EEE | / | / | / | / | / | / | / | / | / | / | / | / |
| 29 | 731617105037 | SANTHOSHKUMAR K | EEE | / | / | / | / | / | / | / | / | / | / | / | / |
| 30 | 731617105038 | SARANSARVESH M | EEE | / | / | / | / | / | / | / | / | / | / | / | / |

TIRUCHENGODE - 621 010,
NAMAKKAL Dt., TAMIL NADU.

| S. No | Reg No | Name | Branch | FN | AN | FN | AN | FN | AN | FN | AN | FN | AN | FN | AN |
|-------------------|--------------|-----------------------|--------|----|----|----|----|----|----|----|----|----|----|----|----|
| 31 | 731617105040 | SASIKUMAR C | EEE | / | / | / | / | / | / | / | / | / | / | / | / |
| 32 | 731617105041 | SELVAM B | EEE | / | / | / | / | / | / | / | / | / | / | / | / |
| 33 | 731617105042 | SHAMEER S | EEE | / | / | / | / | / | / | / | / | / | / | / | / |
| 34 | 731617105044 | SHYAM PRASHAD S | EEE | / | / | / | / | / | / | / | / | / | / | / | / |
| 35 | 731617105045 | SILAMBARASAN S | EEE | / | / | / | / | / | / | / | / | / | / | / | / |
| 36 | 731617105046 | SUJITH S (11.02.2000) | EEE | / | / | / | / | / | / | / | / | / | / | / | / |
| 37 | 731617105047 | SUJITH S | EEE | / | / | / | / | / | / | / | / | / | / | / | / |
| 38 | 731617105048 | SUPRIYA K | EEE | / | / | / | / | / | / | / | / | / | / | P | P |
| 39 | 731617105049 | SURESH P | EEE | / | / | / | / | / | / | / | / | / | / | / | / |
| 40 | 731617105050 | SURYA P | EEE | / | / | / | / | / | / | / | / | / | / | / | / |
| 41 | 731617105052 | THAMIZHSELVAN R | EEE | / | / | / | / | / | / | / | / | P | P | P | P |
| 42 | 731617105054 | VENKATESAN M | EEE | / | / | / | / | / | / | / | / | / | / | / | / |
| 43 | 731617105055 | VINOTH KUMAR R | EEE | / | / | / | / | / | / | / | / | / | / | / | / |
| 44 | 731617104002 | AGILAN R | CSE | / | / | / | / | / | / | / | / | / | / | / | / |
| 45 | 731617104004 | ARUN KUMAR N | CSE | / | / | / | / | / | / | / | / | / | / | / | / |
| 46 | 731617104005 | BABU R | CSE | / | / | / | / | / | / | / | / | / | / | / | / |
| 47 | 731617104007 | CHOWMIYA S B | CSE | / | / | / | / | / | / | / | / | / | / | / | / |
| 48 | 731617104008 | DEEPAK KUMAR J | CSE | / | / | / | / | / | / | / | / | / | / | / | / |
| 49 | 731617104009 | DERIL CHARLESS K | CSE | / | / | / | / | / | / | / | / | / | / | / | / |
| 50 | 731617104031 | MOHANAPREYA N | CSE | / | / | / | / | / | / | / | / | / | / | / | / |
| 51 | 731617104012 | DINESHKUMAR K | CSE | / | / | / | / | / | / | / | / | / | / | / | / |
| 52 | 731617104014 | GAYATHRI M | CSE | / | / | / | / | / | / | / | / | / | / | / | / |
| 53 | 731617104015 | GAYATHRI M | CSE | / | / | / | / | / | / | / | / | P | P | P | P |
| 54 | 731617104016 | GOWTHAM G | CSE | / | / | / | / | / | / | / | / | / | / | / | / |
| 55 | 731617104020 | HARISH P | CSE | / | / | / | / | / | / | / | / | / | / | / | / |
| 56 | 731617104021 | KAILASH K | CSE | / | / | / | / | / | / | / | / | / | / | / | / |
| 57 | 731617104024 | KISHOR P | CSE | A | A | / | / | / | / | / | / | / | / | / | / |
| PRESENT | | | | 54 | 54 | 57 | 57 | 57 | 57 | 57 | 57 | 54 | 54 | 52 | 52 |
| ABSENT | | | | 3 | 3 | 0 | 0 | 0 | 0 | 0 | 0 | 0 | 0 | 1 | 1 |
| PERMISSION | | | | 0 | 0 | 0 | 0 | 0 | 0 | 0 | 0 | 3 | 3 | 4 | 4 |

PRINCIPAL,
K. S. R. INSTITUTE FOR
ENGINEERING AND TECHNOLOGY,
K. S. R. KALYANAGAR,
TIRUCHENGODE - 637 215,
NAMAKKAL Dt, TAMIL NADU.

Batch2 - Face Aptitude Training Attendance (Odd Semester)

| BATCH : 2017 - 2021 | | Incharge: IT/CSE | | Hall No: 108 | | | | Academic Year: 2019 - 2020 | | | | | | | |
|----------------------------|--------------|----------------------|--------|--------------|----|----------|----|----------------------------|----|----------|----|----------|----|----------|----|
| Date of Training Programme | | | | 01.07.19 | | 02.07.19 | | 03.07.19 | | 04.07.19 | | 05.07.19 | | 06.07.19 | |
| S. No | Reg No | Name | Branch | FN | AN | FN | AN | FN | AN | FN | AN | FN | AN | FN | AN |
| 1 | 731617205001 | AJAY SRIRAM K | IT | A | A | / | / | / | / | / | / | / | / | / | / |
| 2 | 731617205002 | ARUL MOZHI M | IT | / | / | / | / | / | / | / | / | / | / | / | / |
| 3 | 731617205003 | BABU U S | IT | / | / | / | / | / | / | / | / | / | / | / | / |
| 4 | 731617205004 | BALAMURUGAN S | IT | / | / | / | / | / | / | / | / | / | / | / | / |
| 5 | 731617205007 | DHINAKARAN K | IT | / | / | / | / | / | / | / | / | / | / | / | / |
| 6 | 731617205010 | GIRINATH S | IT | / | / | / | / | / | / | / | / | / | / | / | / |
| 7 | 731617205011 | GOBIKA M | IT | / | / | / | / | / | / | / | / | / | / | / | / |
| 8 | 731617205013 | HARI PRASATH K | IT | / | / | / | / | / | / | / | / | / | / | / | / |
| | 731617205014 | JESSICA COLLINS | IT | / | / | / | / | / | / | / | / | / | / | / | / |
| 10 | 731617205016 | JOTHEESHWARAN R | IT | / | / | / | / | / | / | / | / | / | / | / | / |
| 11 | 731617205018 | KALIDASS R | IT | / | / | / | / | / | / | / | / | / | / | / | / |
| 12 | 731617205019 | KANNAN P | IT | / | / | / | / | / | / | / | / | P | P | / | / |
| 13 | 731617205021 | KARTHIK T | IT | / | / | A | A | / | / | / | / | / | / | / | / |
| 14 | 731617205025 | LAKSHMANAN R | IT | / | / | / | / | / | / | / | / | / | / | / | / |
| 15 | 731617205026 | MANIKANDAN A | IT | / | / | / | / | / | / | / | / | / | / | / | / |
| 16 | 731617205027 | MOUNISH G | IT | / | / | / | / | / | / | / | / | / | / | / | / |
| 17 | 731617205030 | NANDHINI S | IT | / | / | / | / | / | / | / | / | / | / | / | / |
| 18 | 731617205031 | NATHIYA V | IT | / | / | / | / | / | / | / | / | / | / | / | / |
| 19 | 731617205033 | NAVEENKUMAR G | IT | / | / | / | / | / | / | / | / | / | / | / | / |
| 20 | 731617205035 | PAVITHRA S | IT | / | / | / | / | / | / | / | / | / | / | / | / |
| 21 | 731617205036 | PRIYADHARSHINI P | IT | / | / | / | / | / | / | / | / | / | / | / | / |
| 22 | 731617205039 | SAANTHOSH BALAJI S N | IT | / | / | / | / | / | / | / | / | / | / | / | / |
| 23 | 731617205040 | SANDHIYA G | IT | / | / | / | / | / | / | / | / | / | / | / | / |
| 24 | 731617205042 | SARAN V | IT | / | / | / | / | / | / | / | / | / | / | / | / |
| 25 | 731617205044 | SATHISHKUMAR V | IT | / | / | / | / | / | / | / | / | / | / | / | / |
| 26 | 731617205045 | SELVAMALAR P | IT | / | / | / | / | / | / | / | / | P | P | / | / |
| 27 | 731617205046 | SHAILAA P M | IT | / | / | / | / | / | / | / | / | / | / | / | / |
| 28 | 731617205047 | SHIVANI N | IT | / | / | / | / | / | / | / | / | / | / | / | / |
| 29 | 731617205048 | SIVASANKARI R | IT | / | / | / | / | / | / | / | / | / | / | / | / |
| 30 | 731617205049 | SREEMATHI INDRA S | IT | / | / | / | / | / | / | / | / | / | / | / | / |

| S. No | Reg No | Name | Branch | FN | AN | FN | AN | FN | AN | FN | AN | FN | AN | FN | AN |
|-------------------|--------------|------------------------|--------|----|----|----|----|----|----|----|----|----|----|----|----|
| 31 | 731617205051 | THANEESWARAN Y G | IT | / | / | / | / | / | / | / | / | / | / | / | / |
| 32 | 731617205052 | THUSMEENA K R | IT | / | / | / | / | / | / | / | / | / | / | / | / |
| 33 | 731617205053 | VENKATESWARAN S | IT | / | / | / | / | / | / | / | / | / | / | / | / |
| 34 | 731617205055 | VINOTHINI R | IT | / | / | / | / | / | / | / | / | / | / | / | / |
| 35 | 731617104025 | KOTEESHWARAN P N | CSE | / | / | / | / | / | / | / | / | / | / | / | / |
| 36 | 731617104026 | KRISHNAMOORTHY S | CSE | / | / | / | / | / | / | / | / | / | / | / | / |
| 37 | 731617104027 | MANORANJITH M | CSE | / | / | / | / | A | A | / | / | / | / | / | / |
| 38 | 731617104028 | MARIMUTHU R | CSE | / | / | / | / | / | / | / | / | / | / | / | / |
| 39 | 731617104029 | MENAGA T | CSE | / | / | / | / | / | / | / | / | / | / | / | / |
| 40 | 731617104034 | POOJA M | CSE | / | / | / | / | / | / | / | / | / | / | / | / |
| 41 | 731617104035 | POOJA SHREE K | CSE | / | / | / | / | / | / | / | / | / | / | / | / |
| 42 | 731617104037 | PRAKASH V | CSE | / | / | / | / | / | / | / | / | / | / | / | / |
| 43 | 731617104039 | PRASANTH T | CSE | / | / | / | / | / | / | / | / | / | / | / | / |
| 44 | 731617104040 | PURUSOTHAMAN R | CSE | / | / | / | / | / | / | / | / | / | / | / | / |
| 45 | 731617104042 | SANGEETHA M | CSE | / | / | / | / | / | / | / | / | / | / | / | / |
| 46 | | SANTHOSHKUMAR | CSE | / | / | P | P | / | / | / | / | / | / | / | / |
| 47 | 731617104045 | SHARMILA A | CSE | / | / | / | / | / | / | / | / | / | / | / | / |
| 48 | 731617104046 | SNEHA P | CSE | / | / | / | / | / | / | / | / | / | / | / | / |
| 49 | 731617104050 | VAISHNAVI V | CSE | / | / | / | / | / | / | / | / | / | / | / | / |
| 50 | 731617104051 | VALENTEENA COLLINS J P | CSE | / | / | / | / | / | / | / | / | / | / | / | / |
| 51 | 731617104052 | VEERALAKSHMI S | CSE | / | / | / | / | / | / | / | / | / | / | / | / |
| 52 | 731617104054 | VIGNESH S | CSE | / | / | / | / | / | / | / | / | / | / | / | / |
| 53 | 731617104055 | VIJAY S | CSE | / | / | / | / | A | A | / | / | / | / | / | / |
| 54 | 731617104058 | YUVASHREE R | CSE | / | / | / | / | / | / | / | / | / | / | / | / |
| 55 | 731617104013 | ELANGO M | CSE | / | / | / | / | / | / | / | / | / | / | / | / |
| 56 | 731617104017 | GUNA M | CSE | / | / | / | / | / | / | / | / | / | / | / | / |
| PRESENT | | | | 55 | 55 | 54 | 54 | 54 | 54 | 56 | 56 | 54 | 54 | 56 | 56 |
| ABSENT | | | | 1 | 1 | 1 | 1 | 2 | 2 | 0 | 0 | 0 | 0 | 0 | 0 |
| PERMISSION | | | | 0 | 0 | 1 | 1 | 0 | 0 | 0 | 0 | 2 | 2 | 0 | 0 |

PRINCIPAL,
K. S. R. INSTITUTE FOR
ENGINEERING AND TECHNOLOGY,
K. S. R. POLYM NAGAR,
TRUCHENGODE - 637 215,
NANAKGAL DI, TAMIL NADU.

Batch 3 - Face Aptitude Training Attendance (Odd Semester)

| BATCH : 2017 - 2021 | | Incharge: ECE | | Hall No: 109 | | | | Academic Year: 2019 - 2020 | | | | | | | |
|----------------------------|--------------|--------------------|--------|--------------|----|----------|----|----------------------------|----|----------|----|----------|----|----------|----|
| Date of Training Programme | | | | 01.07.19 | | 02.07.19 | | 03.07.19 | | 04.07.19 | | 05.07.19 | | 06.07.19 | |
| S. No | Reg No | Name | Branch | FN | AN | FN | AN | FN | AN | FN | AN | FN | AN | FN | AN |
| 1 | 731617106002 | ABINAYA T | ECE | / | / | / | / | / | / | / | / | / | / | / | / |
| 2 | 731617106003 | ALKA P | ECE | / | / | / | / | / | / | / | / | / | / | / | / |
| 3 | 731617106004 | ANBAZHAGAN K | ECE | / | / | / | / | / | / | / | / | / | / | / | / |
| 4 | 731617106006 | BALAKUMARAN N | ECE | / | / | / | / | / | / | / | / | / | / | / | / |
| 5 | 731617106007 | BOOMA V | ECE | / | / | / | / | / | / | / | / | / | / | / | / |
| 6 | 731617106008 | DARANIDARAN R S | ECE | / | / | / | / | / | / | / | / | / | / | / | / |
| 7 | 731617106010 | DHANISH V | ECE | / | / | / | / | / | / | / | / | / | / | / | / |
| 8 | 731617106011 | DHANUSHKODI N | ECE | / | / | / | / | / | / | / | / | / | / | / | / |
| 9 | 731617106012 | DHARNISH K | ECE | / | / | / | / | / | / | / | / | / | / | / | / |
| 10 | 731617106014 | DINESH U G | ECE | / | / | / | / | / | / | / | / | / | / | / | / |
| 11 | 731617106015 | DINNESH P | ECE | / | / | / | / | / | / | / | / | / | / | / | / |
| 12 | 731617106016 | GEETHARANI G | ECE | / | / | / | / | / | / | / | / | / | / | / | / |
| 13 | 731617106017 | GOKULNATH N | ECE | / | / | / | / | / | / | / | / | / | / | / | / |
| 14 | 731617106018 | GOKULNATH R | ECE | / | / | / | / | / | / | / | / | / | / | / | / |
| 15 | 731617106019 | GOWTHAM M | ECE | / | / | / | / | / | / | / | / | / | / | / | / |
| 16 | 731617106020 | HARI HARA SUDHAN R | ECE | / | / | / | / | / | / | / | / | / | / | / | / |
| 17 | 731617106021 | HARIKRISHNAN M | ECE | / | / | / | / | / | / | / | / | / | / | / | / |
| | 731617106023 | HEMAHARINI S | ECE | / | / | / | / | / | / | / | / | / | / | / | / |
| 19 | 731617106024 | HEMALATHA S | ECE | / | / | / | / | / | / | / | / | / | / | P | P |
| 20 | 731617106025 | JANARTH S | ECE | / | / | / | / | / | / | / | / | / | / | / | / |
| 21 | 731617106027 | JAWAHAR RAJA P | ECE | / | / | / | / | / | / | / | / | / | / | / | / |
| 22 | 731617106028 | KAMALESHWARAN R | ECE | / | / | / | / | / | / | / | / | / | / | P | P |
| 23 | 731617106029 | KAMALINI N | ECE | / | / | / | / | / | / | / | / | / | / | / | / |
| 24 | 731617106030 | KARTHIKA C | ECE | / | / | / | / | / | / | / | / | / | / | / | / |
| 25 | 731617106031 | KEERTHANA S | ECE | / | / | / | / | / | / | / | / | / | / | / | / |
| 26 | 731617106032 | KEERTHIVASAN N | ECE | / | / | / | / | / | / | / | / | / | / | / | / |
| 27 | 731617106033 | KISHOR M | ECE | / | / | / | / | / | / | / | / | / | / | / | / |

PRINCIPAL
K. S. R. INSTITUTE FOR
ENGINEERING AND TECHNOLOGY,
TIRUCHENGODE - 637 215,
NAMAKKAL Dt, TAMIL NADU.

| Date of Training Programme | | | | 01.07.19 | 02.07.19 | 03.07.19 | 04.07.19 | 05.07.19 | 06.07.19 | | | | | | |
|----------------------------|--------------|----------------------|--------|----------|----------|----------|----------|----------|----------|----|----|----|----|----|----|
| S. No | Reg No | Name | Branch | FN | AN | FN | AN | FN | AN | FN | AN | FN | AN | FN | AN |
| 28 | 731617106034 | KISHORE D | ECE | / | / | / | / | / | / | / | / | / | / | / | / |
| 29 | 731617106035 | LAKSHMANAN S | ECE | / | / | / | / | / | / | / | / | / | / | / | / |
| 30 | 731617106036 | MADHANGOPAL C | ECE | / | / | / | / | / | / | / | / | / | / | / | / |
| 31 | 731617106037 | MANIMALA R | ECE | / | / | / | / | / | / | / | / | / | / | / | / |
| 32 | 731617106038 | MANJULA T | ECE | / | / | / | / | / | / | / | / | / | / | / | / |
| 33 | 731617106039 | MERIN KUMAR L | ECE | / | / | / | / | / | / | / | / | / | / | / | / |
| 34 | 731617106040 | MUSHIDHA SIFANA T | ECE | / | / | / | / | / | / | / | / | / | / | / | / |
| 35 | 731617106041 | MUTHULAKSHMI S | ECE | / | / | / | / | / | / | / | / | / | / | / | / |
| 36 | 731617106701 | ARAVINTH R | ECE | / | / | / | / | / | / | / | / | / | / | / | / |
| 37 | 731617106042 | NAVEEN.L | ECE | / | / | / | / | / | / | / | / | / | / | P | P |
| 38 | 731617106043 | NAVEEN.S.S | ECE | / | / | / | / | / | / | / | / | / | / | / | / |
| 39 | 731617106045 | PARKAVI P | ECE | / | / | / | / | / | / | / | / | / | / | / | / |
| 40 | 731617106046 | PARKAVIS | ECE | / | / | / | / | / | / | / | / | / | / | / | / |
| 41 | 731617106047 | PAVITHRA T | ECE | / | / | / | / | / | / | / | / | / | / | / | / |
| 42 | 731617106048 | PREMELA R | ECE | / | / | / | / | / | / | / | / | / | / | / | / |
| 43 | 731617106050 | PRIYANKA V | ECE | / | / | / | / | / | / | / | / | / | / | / | / |
| 44 | 731617106051 | RAGHURAMACHANDIRAN.V | ECE | / | / | / | / | / | / | / | / | / | / | / | / |
| 45 | 731617106052 | RAMYA S | ECE | / | / | / | / | / | / | / | / | / | / | / | / |
| 46 | 731617106055 | RUBAN PRASAD J | ECE | / | / | / | / | / | / | / | / | / | / | / | / |
| 47 | 731617106056 | SANDHIYA K | ECE | / | / | / | / | / | / | / | / | / | / | / | / |
| 48 | 731617106057 | SANTHIYA T | ECE | / | / | / | / | / | / | / | / | / | / | / | / |
| 49 | 731617106058 | SANTHIYA Y | ECE | / | / | / | / | / | / | / | / | / | / | / | / |
| 50 | 731617106059 | SANTHOSH.K | ECE | / | / | / | / | / | / | / | / | / | / | / | / |
| 51 | 731617106061 | SHANMATHI M M | ECE | / | / | / | / | / | / | / | / | / | / | / | / |
| 52 | 731617106062 | SHARUMATHI S | ECE | / | / | / | / | / | / | / | / | / | / | P | P |
| 53 | 731617106063 | SINDUJA K | ECE | / | / | / | / | / | / | / | / | / | / | / | / |
| 54 | 731617106067 | SREEMATHI.G | ECE | / | / | / | / | / | / | / | / | / | / | / | / |
| 55 | 731617106068 | SRIDHARAN M | ECE | / | / | / | / | / | / | / | / | / | / | P | / |
| 56 | 731617106069 | SRINIVASAN A | ECE | / | / | / | / | / | / | / | / | / | / | / | / |
| 57 | 731617106070 | SRINIVASAN S R | ECE | / | / | / | / | / | / | / | / | / | / | / | / |
| 58 | 731617106071 | SRI RANJANI S | ECE | / | / | / | / | / | / | / | / | / | / | / | / |

| Date of Training Programme | | | | 01.07.19 | | 02.07.19 | | 03.07.19 | | 04.07.19 | | 05.07.19 | | 06.07.19 | |
|----------------------------|--------------|-------------------|--------|----------|----|----------|----|----------|----|----------|----|----------|----|----------|----|
| S. No | Reg No | Name | Branch | FN | AN | FN | AN | FN | AN | FN | AN | FN | AN | FN | AN |
| 59 | 731617106073 | SUBASH K | ECE | / | / | / | / | / | / | / | / | / | / | / | / |
| 60 | 731617106075 | SUKHESAN C | ECE | / | / | / | / | / | / | / | / | / | / | / | / |
| 61 | 731617106077 | SURYAPRIYA K | ECE | / | / | / | / | / | / | / | / | / | / | / | / |
| 62 | 731617106078 | SUSHMITHA.A | ECE | / | / | / | / | / | / | / | / | / | / | / | / |
| 63 | 731617106079 | SWEETLIN JOSHVA.A | ECE | / | / | / | / | / | / | / | / | / | / | / | / |
| 64 | 731617106080 | SWETHA G P | ECE | / | / | / | / | / | / | / | / | / | / | / | / |
| 65 | 731617106081 | TAMILZHAGAN G | ECE | / | / | / | / | / | / | / | / | / | / | / | / |
| 66 | 731617106082 | TEJASWINI S | ECE | / | / | / | / | / | / | / | / | / | / | / | / |
| 67 | 731617106084 | THIYAGU M | ECE | / | / | / | / | / | / | / | / | / | / | / | / |
| 68 | 731617106086 | YASODHA P | ECE | / | / | / | / | / | / | / | / | / | / | / | / |
| 69 | 731617106087 | YUVANSANKAR K | ECE | / | / | / | / | / | / | / | / | / | / | / | / |
| | 731617106064 | SIVASANKARAN K | ECE | / | / | / | / | / | / | / | / | / | / | / | / |
| 71 | 731617106074 | SUDHA G | ECE | / | / | / | / | A | A | / | / | A | A | / | / |
| 72 | 731617106022 | HARISHKUMAR | ECE | / | / | / | / | / | / | / | / | / | / | / | / |
| PRESENT | | | | 72 | 72 | 72 | 72 | 71 | 71 | 72 | 72 | 71 | 68 | 68 | 68 |
| ABSENT | | | | 0 | 0 | 0 | 0 | 1 | 1 | 0 | 0 | 1 | 1 | 0 | 0 |
| PERMISSION | | | | 0 | 0 | 0 | 0 | 0 | 0 | 0 | 0 | 0 | 3 | 4 | 4 |

PRINCIPAL,
K. S. R. INSTITUTE FOR
ENGINEERING AND TECHNOLOGY,
K. S. R. KALVI NAGAR,
TIRUCHENGODE - 637 215,
NAMAKKAL Dt, TAMIL NADU.

| S No | College ID | Name | Branch | Sentence Completion and ParaJumbles (15) | Reading Comprehension (15) | Total |
|------|--------------|-------------------------|-----------|--|----------------------------|-------|
| 1 | 731617104002 | AGILAN R | CSE | 15 | 9 | 24 |
| 2 | 731617104008 | DEEPAK KUMAR.J | CSE | 14 | 8 | 22 |
| 3 | 731617104009 | DERIL CHARLESS K | CSE | 14 | 8 | 22 |
| 4 | 731617105002 | ASHA R | EEE | 9 | 11 | 20 |
| 5 | 731617105048 | K.SUPRIYA | EEE | 13 | 7 | 20 |
| 6 | 731617105004 | Bharath.S | EEE | 12 | 7 | 19 |
| 7 | 731617105022 | M.MANJUPRIYA | EEE | 10 | 9 | 19 |
| 8 | 731617105044 | Shyam Prashad S | EEE | 9 | 10 | 19 |
| 9 | 731617105028 | T.PERARIVU EZHIL ARASAN | EEE | 11 | 6 | 17 |
| 10 | 731617105020 | S.Kirubakar | 3EE-A1 | 9 | 7 | 16 |
| 11 | 731617105024 | MOHAN T | EEE | 9 | 7 | 16 |
| 12 | 731617105035 | RAMYA.P | EEE | 8 | 8 | 16 |
| 13 | 731617105047 | Sujith.S | EEE | 8 | 8 | 16 |
| 14 | 731617105025 | NANDAKUMAARAN S | EEE | 4 | 11 | 15 |
| 15 | 731617104004 | Arun | CSE | 6 | 9 | 15 |
| 16 | 731617104007 | S.B chowmiya | CSE | 9 | 6 | 15 |
| 17 | 731617104012 | DINESHKUMAR K | CSE | 9 | 6 | 15 |
| 18 | 731617105001 | arul m | EEE | 8 | 6 | 14 |
| 19 | 731617105005 | Dinesh C | EEE | 6 | 8 | 14 |
| 20 | 1592787 | KAMALAHASAN G | EEE | 7 | 7 | 14 |
| 21 | 731617105027 | PARAMASIVAM R | EEE | 5 | 9 | 14 |
| 22 | 731617105036 | sakthivel.p | EEE | 8 | 6 | 14 |
| 23 | 731617105050 | surya.p | EEE | 7 | 7 | 14 |
| 24 | 731617105009 | guganesh.r | EEE | 6 | 7 | 13 |
| 25 | 731617105041 | SELVAM.B | EEE | 5 | 8 | 13 |
| 26 | 731617105046 | S.SUJITH | EEE | 7 | 6 | 13 |
| 27 | 731617104016 | GOWTHAM G | CSE | 0 | 13 | 13 |
| 28 | 731617105019 | KAVIN MUTHU KUMAR | EEE | 4 | 8 | 12 |
| 29 | 731617105021 | C LOGESWARN | MTRE | 5 | 7 | 12 |
| 30 | 731617105038 | saransarvesh m | EEE | 4 | 8 | 12 |
| 31 | 731617105045 | S SILAMBARASAN | EEE | 4 | 8 | 12 |
| 32 | 731617105054 | VENKATESAN.M | EEE FOR | 7 | 5 | 12 |
| 33 | 731617105010 | hari s.r | EEE | 4 | 7 | 11 |
| 34 | 731617105014 | JEEVITHA G | EC 37 215 | 6 | 5 | 11 |
| 35 | 731617105017 | M.KARTHIKEYAN | EEE | 5 | 6 | 11 |

| S No | College ID | Name | Branch | Sentence Completion and ParaJumbles (15) | Reading Comprehension (15) | Total |
|------|--------------|-----------------|--------|--|----------------------------|-------|
| 36 | 731617105003 | BALAJI S | EEE | 7 | 3 | 10 |
| 37 | 731617105008 | S. P. GOWTHAM | EEE | 4 | 6 | 10 |
| 38 | 731617105013 | Jeevanandam T | EEE | 3 | 7 | 10 |
| 39 | 731617105033 | RAJAT KUMAR | EEE | 3 | 7 | 10 |
| 40 | 731617105049 | Suresh.p | EEE | 4 | 6 | 10 |
| 41 | 731617104031 | N.MOHANAPREYA | CSE | 4 | 6 | 10 |
| 42 | 731617104015 | M.GAYATHRI | CSE | 5 | 5 | 10 |
| 43 | 1592789 | KAVINKUMAR M | EE | 3 | 6 | 9 |
| 44 | 731617105023 | s.Manoj kumar | EEE | 0 | 9 | 9 |
| 45 | 731617105037 | K.SANTHOSHKUMAR | EEE | 4 | 5 | 9 |
| 46 | 731617104005 | Babu | CSE | 6 | 3 | 9 |
| 47 | 731617104014 | M.Gayathri | CSE | 3 | 6 | 9 |
| 8 | 731617104021 | kailash | CSE | 0 | 9 | 9 |
| 49 | 731617105042 | shameer.s | EEE | 3 | 5 | 8 |
| 50 | 731617106064 | sivasankaran.k | ECE | 2 | 6 | 8 |
| 51 | 731617105055 | Vinoth Kumar | EEE | 1 | 6 | 7 |
| 52 | 731617105032 | M.PRAVEEN KUMAR | EEE | 3 | 3 | 6 |
| 53 | 1592806 | SASIKUMAR C | EEE | 1 | 4 | 5 |
| 54 | 731617105052 | THAMIZHSELVAN R | EEE | 1 | 4 | 5 |
| 55 | 731617106074 | SUDHA.G | ECE | 0 | 3 | 3 |



 PRINCIPAL,
 K. S. R. INSTITUTE FOR
 ENGINEERING AND TECHNOLOGY,
 K. S. R. COLLEGE LAGAR,
 TIRUCHENGODE - 637 215,
 NAMAKKAL Dt, TAMIL NADU.

Batch:2017 -2021

Academic Year : 2019 - 2021

| S No | College ID | Name | Department | Sentence Completion and ParaJumbles (15) | Sentence Correction (15) | Total |
|------|---------------|-----------------------------|------------|--|--------------------------|-------|
| 1 | 731617104037 | Prakash V | CSE | 15 | 4 | 19 |
| 2 | 731617205049 | SREEMATHI INDRA | IT | 7 | 9 | 16 |
| 3 | 1592895 | Santhoshkumar A | CSE | 8 | 8 | 16 |
| 4 | 731617205046 | shailaa.p.m | IT | 7 | 8 | 15 |
| 5 | 731617205014 | JESSICA COLLINS J.PRINCE | IT | 5 | 10 | 15 |
| 6 | 731617104051 | Valenteena Collins J Prince | CSE | 7 | 8 | 15 |
| 7 | 731617205033 | NAVEEN KUMAR.G | IT | 11 | 3 | 14 |
| 8 | 731617205027 | Mounish | IT | 8 | 6 | 14 |
| 9 | 731617104034 | Pooja M | CSE | 7 | 7 | 14 |
| 10 | 731617205030 | S.NANDHINI | IT | 7 | 6 | 13 |
| 11 | 731617205011 | GOBIKA M | IT | 5 | 8 | 13 |
| 12 | 731617205003 | BABU | IT | 7 | 6 | 13 |
| 13 | 731617104017 | GUNA M | CSE | 8 | 5 | 13 |
| 14 | 731617104052 | S.Veeralakshmi | CSE | 6 | 7 | 13 |
| 15 | 731617104045 | Sharmila.A | CSE | 6 | 7 | 13 |
| 16 | 731617104050 | VAISHNAVI.V | CSE | 6 | 7 | 13 |
| 17 | 731617104028 | R.Marimuthu | CSE | 5 | 8 | 13 |
| 18 | 731617104026 | Krishnamoorthy.S | CSE | 7 | 6 | 13 |
| 19 | 731617205051 | THANESSHWARAN YG | IT | 7 | 6 | 13 |
| 20 | 731617205052 | Thusmeena K.R. | IT | 7 | 5 | 12 |
| 21 | 731617205040 | SANDHIYA G | IT | 9 | 3 | 12 |
| 22 | 731617205025 | Lakshmanan R | IT | 8 | 4 | 12 |
| 23 | 731617205053 | venkateshwaran s | IT | 5 | 7 | 12 |
| 24 | 731617205047 | N shivani | IT | 6 | 5 | 11 |
| 25 | 731617205002 | ARULMOZHI M | IT | 6 | 5 | 11 |
| 26 | 731617205055 | VINOTHINI R | IT | 10 | 1 | 11 |
| 27 | 2731617104025 | koteeshwaran P.N | CSE | 7 | 4 | 11 |
| 28 | 731617104035 | K. Pooja shree | CSE | 7 | 4 | 11 |

| | | | | | | |
|----|--------------|----------------------|-------|---|---|----|
| 29 | 731617205039 | SAANTHOSH BALAJI S.N | IT | 5 | 6 | 11 |
| 30 | 731617205048 | SIVASANKARI.R | IT | 5 | 5 | 10 |
| 31 | 731617104058 | Yuvashree .R | CSE | 3 | 7 | 10 |
| 32 | 731617104054 | VIGNESH S | CSE | 5 | 5 | 10 |
| 33 | 731617104055 | vijay.s | CSE | 6 | 4 | 10 |
| 34 | 731617205004 | S.BALAMURUGAN | 3IT-2 | 5 | 5 | 10 |
| 35 | 731617205007 | Dhinakaran.K | IT | 7 | 2 | 9 |
| 36 | 731617205044 | SATHISHKUMAR V | IT | 5 | 4 | 9 |
| 37 | 731617104046 | Sneha.P | CSE | 6 | 3 | 9 |
| 38 | 731617104042 | M.Sangeetha | CSE | 4 | 5 | 9 |
| 39 | 731617205016 | JOTHEESWARAN R | CSE | 3 | 6 | 9 |
| 40 | 731617205045 | selvamalar p | IT | 5 | 3 | 8 |
| 41 | 731617205021 | KARTHIK.T | IT | 5 | 3 | 8 |
| 42 | 731617205010 | GIRINATH S | IT | 4 | 4 | 8 |
| 43 | 731617205042 | saran v | IT | 5 | 3 | 8 |
| 44 | 731617104013 | Elango.M | CSE | 5 | 3 | 8 |
| 45 | 17ietit018 | kalidass | IT | 4 | 4 | 8 |
| 46 | 731617104040 | purusothaman R | CSE | 6 | 2 | 8 |
| 47 | 731617205026 | A.MANIKANDAN | 3IT-2 | 5 | 3 | 8 |
| 48 | 731617205035 | pavithra s | IT | 5 | 2 | 7 |
| 49 | 731617104029 | Menaga.T | CSE | 5 | 2 | 7 |
| 50 | 731617104027 | M.MANORANJITH | CSE | 0 | 7 | 7 |
| 51 | 1592894 | Prasanth.T | CSE | 0 | 7 | 7 |
| 52 | 731617205013 | HARIPRASATH K | IT | 4 | 3 | 7 |
| 53 | 731617205036 | priyadharshini p | IT | 3 | 3 | 6 |
| 54 | 17ietit031 | Nathiya.V | IT | 4 | 1 | 5 |

PRINCIPAL,
K. S. R. INSTITUTE FOR
ENGINEERING AND TECHNOLOGY,
K. S. R. ROAD,
TIRUCHENGODE - 637 215,
NAMAKKAL Dt., TAMIL NADU.

TRAINING AND PLACEMENT CELL

Day 1 - Batch 3 - Assessment Report by FACE Trainers

Batch:2017 -2021

Academic Year : 2019 - 2020

| S No | College ID | Name | Branch | Reading Comprehension (15) | Sentence Correction (15) | Total |
|------|-----------------|----------------------|--------|----------------------------|--------------------------|-------|
| 1 | 1592967 | sharumathi.s | ECE | 12 | 11 | 23 |
| 2 | 731617106015 | DINNESH.P | ECE | 9 | 8 | 17 |
| 3 | 1592956 | pavithra.T | ECE | 6 | 11 | 17 |
| 4 | 731617106003 | Alka p | ECE | 6 | 10 | 16 |
| 5 | 731617106061 | M M SHANMATHI | ECE | 8 | 8 | 16 |
| 6 | 731617106063 | SINDUJA.K | ECE | 8 | 8 | 16 |
| 7 | 731617106023 | Hemaharini.S | ECE | 8 | 7 | 15 |
| 8 | 731617106030 | C.KARTHIKA | ECE | 8 | 7 | 15 |
| 9 | 731617106031 | s.keerthana | ECE | 10 | 5 | 15 |
| 10 | 1592976/7316171 | SURYAPRIYA.K | ECE | 7 | 8 | 15 |
| 11 | 731617106035 | lakshmanan s | ECE | 9 | 5 | 14 |
| 12 | 731617106071 | SRI RANJANI S | ECE | 8 | 6 | 14 |
| 13 | 731617106078 | SUSHMITHA.A | ECE | 8 | 6 | 14 |
| 14 | 731617106021 | M.HARIKRISHNAN | ECE | 5 | 8 | 13 |
| 15 | 731617106025 | JANARTH S | ECE | 8 | 5 | 13 |
| 16 | 731617106042 | NAVEEN.L | ECE | 11 | 2 | 13 |
| 17 | 731617106068 | M.SRIDHARAN | ECE | 6 | 7 | 13 |
| 18 | 731617106080 | G P SWETHA | ECE | 7 | 6 | 13 |
| 19 | 1592921 | R.S.Daranidaran | ECE | 6 | 6 | 12 |
| 20 | 731617106020 | HARI HARA SUDHAN. R | ECE | 8 | 4 | 12 |
| 21 | 731617106037 | Manimala .R | ECE | 6 | 6 | 12 |
| 22 | 731617106050 | PRIYANKA . V | ECE | 5 | 7 | 12 |
| 23 | 731617106052/15 | RAMYA S | ECE | 6 | 6 | 12 |
| 24 | 731617106056 | sandhiya.k | ECE | 9 | 3 | 12 |
| 25 | 731617106082 | S.TEJASWINI | ECE | 6 | 6 | 12 |
| 26 | 1592983/7316171 | UDAYAKUMAR.R | ECE | 9 | 3 | 12 |
| 27 | 731617106046 | PARKAVI S | ECE | 6 | 5 | 11 |
| 28 | 731617106051 | RAGHURAMACHANDIRAN.V | ECE | 5 | 6 | 11 |
| 29 | 731617106081 | TAMILZHAGAN G | ECE | 6 | 5 | 11 |
| 30 | 731617106002 | T.ABINAYA | ECE | 4 | 6 | 10 |
| 31 | 731617106017 | GOKULNATH.N | ECE | 6 | 4 | 10 |
| 32 | 731617106029 | N.Kamalini | ECE | 7 | 3 | 10 |
| 33 | 731617106033 | KISHOR.M | ECE | 7 | 3 | 10 |
| 34 | 731617106038 | Manjula.T | ECE | 8 | 2 | 10 |
| 35 | 731617106040 | Mushidha sifana.T | ECE | 5 | 5 | 10 |
| 36 | 1592951 | ARAVINTH R | ECE | 2 | 8 | 10 |
| 37 | 731617106043 | NAVEEN S. S | ECE | 8 | 2 | 10 |

TIRUCHENGODE
NARAYANAN COLLEGE OF ENGINEERING
TAMIL NADU.

| S No | College ID | Name | Branch | Reading Comprehension (15) | Sentence Correction (15) | Total |
|------|-----------------|------------------------|--------|----------------------------|--------------------------|-------|
| 38 | 1592957 | premela | ECE | 4 | 6 | 10 |
| 39 | 731617106055 | j.ruban prasad | ECE | 3 | 7 | 10 |
| 40 | 731617106058 | SANTHIYA.Y | ECE | 6 | 4 | 10 |
| 41 | 1592969 | SREEMATHI.G | ECE | 4 | 6 | 10 |
| 42 | 731617106086 | YASODHA P | ECE | 6 | 4 | 10 |
| 43 | 1592919 | BALAKUMARAN.N. | ECE | 4 | 5 | 9 |
| 44 | 731617106007 | Booma | ECE | 6 | 3 | 9 |
| 45 | 1592922 | Dhanish | ECE | 5 | 4 | 9 |
| 46 | 6381718918 | u.G.DINESH | ECE | 5 | 4 | 9 |
| 47 | 731617106019 | Gowtham.M | ECE | 6 | 3 | 9 |
| 48 | 731617106024 | S.HEMALATHA | ECE | 7 | 2 | 9 |
| 49 | 731617106027 | Jawahar Raja.P | ECE | 5 | 4 | 9 |
| 50 | 731617106028 | KAMALESHWARAN RAVICHAN | ECE | 6 | 3 | 9 |
| 51 | 731617106034 | KISHORE D | ECE | 4 | 5 | 9 |
| 52 | 1592950 | muthulakshmi.s | ECE | 8 | 1 | 9 |
| 53 | 15929775 | SUKHESAN C | ECE | 6 | 3 | 9 |
| 54 | 731617106087 | YUVANSANKAR K | ECE | 6 | 3 | 9 |
| 55 | 1592918 | Anbazhagan.k | ECE | 4 | 4 | 8 |
| 56 | 731617106011 | DHANUSHKODI.N | ECE | 6 | 2 | 8 |
| 57 | 731617106018 | GOKULNATH.R | ECE | 7 | 1 | 8 |
| 58 | 731617106032 | KEERTHIVASAN.N | ECE | 6 | 2 | 8 |
| 59 | 731617106036 | MADHANGOPAL C | ECE | 5 | 3 | 8 |
| 60 | 731617106057 | SANTHIYA.T | ECE | 6 | 2 | 8 |
| 61 | 731617106070 | SRINIVASAN.S.R | ECE | 4 | 4 | 8 |
| 62 | 731617106073 | subash k | ECE | 4 | 4 | 8 |
| 63 | 731617106079 | A.sweetlin joshva | ECE | 4 | 4 | 8 |
| 64 | 731617106016 | G.GEETHARANI | ECE | 5 | 2 | 7 |
| 65 | 731617106045 | PARKAVI.P | ECE | 5 | 2 | 7 |
| 66 | 1592948 | MERIN KUMAR L | ECE | 1 | 5 | 6 |
| 67 | 731617106012/12 | dharnish k | ECE | 5 | 0 | 5 |
| 68 | 731617106069 | A.SRINIVASAN | ECE | 2 | 3 | 5 |
| 69 | 731617106084 | M.Thiyagu | ECE | 4 | 0 | 4 |

PRINCIPAL,
K. S. R. INSTITUTE FOR
ENGINEERING & TECHNOLOGY,
K. S. R. ROAD NAGAR,
TIRUCHENGODE - 637 215,
NAMAKKAL Dt, TAMIL NADU.



Name of the Student: Valenteena Collins J. Prince Branch: Comp Science and

Year / Sem: III / 5

1. Name of the Training: Sentence Completion and para jumbles, Sentence correction

2. Name of the Trainer: (B) - Indhumathy (A) - Suparna

3. Students rating of Trainers: morng session: (A) aftn session: (B) [4.5]

| S. No. | Date | Subject | Rating (✓) | | | |
|--------|------------|---------|------------|-----------|------|---------|
| | | | Excellent | Very good | Good | Average |
| 1 | 01/07/2019 | A | | ✓ | | |
| | | B | ✓ | | | |

4. Two positive points about the programme: i) exploring more ii) makes our english communication much better.

5. Suggestions for improvement: Have to go slow.

Valenteena

Date: 01/07/2019

Signature



Name of the Student: S. Sharumathi Branch: ECE

Year / Sem: II / IV

1. Name of the Training: verbal

2. Name of the Trainer: -trasa

3. Students rating of Trainers: 4

| S. No. | Date | Subject | Rating (✓) | | | |
|--------|--------|-----------------------|------------|-----------|------|---------|
| | | | Excellent | Very good | Good | Average |
| 1 | 1.7.19 | Reading comprehension | ✓ | ✓ | | |

4. Two positive points about the programme: → encouraging us to ask more doubts

→ good interactive session

5. Suggestions for improvement:

→ voice is not audible.

TRAINING PROGRAMME FEEDBACK FORM



Name of the Student: Mesin Kumar Branch: ECE

Year / Sem: III / V

1. Name of the Training: Reading Comprehension
2. Name of the Trainer: Tresa
3. Students rating of Trainers: (5/5)

| S. No. | Date | Subject | Rating (✓) | | | |
|--------|----------|-----------------------|------------|-----------|------|---------|
| | | | Excellent | Very good | Good | Average |
| 1 | 1.7.2019 | Reading Comprehension | ✓ | | | |

4. Two positive points about the programme: To covering each and every student as possible.

5. Suggestions for improvement: they should not use mic & projector

Date: 1.7.2019

please ask them to use it.

L. Merin
Signature

TRAINING PROGRAMME FEEDBACK FORM



Name of the Student: AIKA P Branch: ECE

Year / Sem: III / V

1. Name of the Training: Subarna Sentence correction
2. Name of the Trainer: Subarna
3. Students rating of Trainers :

| S. No. | Date | Subject | Rating (✓) | | | |
|--------|--------|---------------|------------|-----------|------|---------|
| | | | Excellent | Very good | Good | Average |
| 1 | 1/7/19 | communication | | ✓ | | |

4. Two positive points about the programme: explain very clearly about all the topics

5. Suggestions for improvement:

Date: 1/7/19

PRINCIPAL,
K. S. R. INSTITUTE FOR
ENGINEERING AND TECHNOLOGY,
K. S. R. KALU LIGAR,
TIRUCHENGODE - 637 215,
NAMAKKAL DISTRICT, TAMIL NADU.

AK
Signature

**K S R INSTITUTE FOR ENGINEERING AND TECHNOLOGY
TIRUCHENGODE - 637 215**

TRAINING PROGRAMME FEEDBACK FORM



Name of the Student: V. Nathiya Branch: IT

Year / Sem: III / IV

1. Name of the Training :

2. Name of the Trainer : Indumathy

3. Students rating of Trainers :

| S. No. | Date | Subject | Rating (✓) | | | |
|--------|--------|----------|------------|-----------|------|---------|
| | | | Excellent | Very good | Good | Average |
| 1 | 1.7.19 | Sentance | | ✓ | | |

4. Two positive points about the programme:

and Synonyms It gives more noun, adjective

5. Suggestions for improvement:

Nil

Date: 1.7.19

V. Nathiya
Signature

**K S R INSTITUTE FOR ENGINEERING AND TECHNOLOGY
TIRUCHENGODE - 637 215**

TRAINING PROGRAMME FEEDBACK FORM



Name of the Student: P. SNEHA Branch: CSE

Year / Sem: III / IV

1. Name of the Training :

2. Name of the Trainer : Indumathy

3. Students rating of Trainers :

| S. No. | Date | Subject | Rating (✓) | | | |
|--------|---------|---------------------|------------|-----------|------|---------|
| | | | Excellent | Very good | Good | Average |
| 1 | 1.07.19 | Sentence completion | ✓ | | | |

4. Two positive points about the programme: Easy to understand.

5. Suggestions for improvement: Interactions is very good.

Date: 01.07.19

PRINCIPAL
K S R INSTITUTE FOR
ENGINEERING AND TECHNOLOGY,
K. S. R. INSTITUTE FOR,
TIRUCHENGODE - 637 215,
NAMAKKAL Dt, TAMIL NADU.

P. Sneha
Signature

K S R INSTITUTE FOR ENGINEERING AND TECHNOLOGY
TIRUCHENGODE - 637 215

TRAINING PROGRAMME FEEDBACK FORM



Name of the Student: Kailash K Branch: CSE

Year / Sem: III / V

1. Name of the Training: Paragraph comprehension

2. Name of the Trainer: Teresa Felix

3. Students rating of Trainers :

| S. No. | Date | Subject | Rating (✓) | | | |
|--------|---------|-----------------------|------------|-----------|------|---------|
| | | | Excellent | Very good | Good | Average |
| 1 | 1.07.19 | Reading comprehension | | | ✓ | |

4. Two positive points about the programme:

* Easy to understand

* Comfortable to listen the class good

5. Suggestions for improvement:

Date: 1.07.19

Signature

K S R INSTITUTE FOR ENGINEERING AND TECHNOLOGY
TIRUCHENGODE - 637 215

TRAINING PROGRAMME FEEDBACK FORM



Name of the Student: Kailash K Branch: CSE

Year / Sem: III / V

1. Name of the Training: Sentence completion

2. Name of the Trainer: Endamathi

3. Students rating of Trainers :

| S. No. | Date | Subject | Rating (✓) | | | |
|--------|---------|---------------------|------------|-----------|------|---------|
| | | | Excellent | Very good | Good | Average |
| 1 | 1.07.19 | Sentence completion | | | ✓ | |

4. Two positive points about the programme:

* Good

5. Suggestions for improvement:

Date:

Signature

PRINCIPAL,
K S R INSTITUTE FOR
ENGINEERING AND TECHNOLOGY,
K. S. R. INSTITUTE FOR
TIRUCHENGODE - 637 215,
NAMAKKAL DISTRICT, TAMIL NADU.

**K S R INSTITUTE FOR ENGINEERING AND TECHNOLOGY
TIRUCHENGODE - 637 215**

TRAINING PROGRAMME FEEDBACK FORM

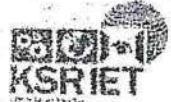

Name of the Student: G. KAMALAHASAN

Branch: EEE

Year / Sem: III / V

1. Name of the Training: VERBAL-APTITUDE

2. Name of the Trainer: INDUMATHI

3. Students rating of Trainers :

| S. No. | Date | Subject | Rating (√) | | | |
|--------|----------|---------|------------|-----------|------|---------|
| | | | Excellent | Very good | Good | Average |
| 1 | 01-07-19 | Verbal | | ✓ | | |

4. Two positive points about the programme:

*Good communication
Good interaction*

5. Suggestions for improvement:

Teach some techniques for improving the grammar.

Date: 01-07-2019

[Signature]
Signature

**K S R INSTITUTE FOR ENGINEERING AND TECHNOLOGY
TIRUCHENGODE - 637 215**

TRAINING PROGRAMME FEEDBACK FORM



Name of the Student: R. ASHA

Branch: EEE

Year / Sem: III / V

1. Name of the Training: READING COMPREHENSION

2. Name of the Trainer: TRESA FELIX

3. Students rating of Trainers :

| S. No. | Date | Subject | Rating (√) | | | |
|--------|----------|---------------------|------------|-----------|------|---------|
| | | | Excellent | Very good | Good | Average |
| 1 | 01-07-19 | Verbal [Reading] | ✓ | | | |

4. Two positive points about the programme:

Good Interaction

5. Suggestions for improvement:

Explanation of passage

Give more passages for practice.

Date: 01-07-19

[Signature]
Signature

TRAINING AND PLACEMENT CELL

Day 2 - Batch 1 - Assessment Report by FACE Trainers

Batch:2017 -2021

Academic Year : 2019 - 2020

| S No | College ID | Name | Branch | Number System | Coding, Series, VR , Odd man out, Analogy | Total |
|------|--------------|-------------------|--------|---------------|---|-------|
| 1 | 731617104009 | DERIL CHARLESS K | CSE | 13 | 15 | 28 |
| 2 | 731617104002 | AGILAN R | CSE | 12 | 13 | 25 |
| 3 | 731617104008 | DEEPAK KUMAR.J | CSE | 14 | 11 | 25 |
| 4 | 731617105023 | s.Manoj kumar | EEE | 7 | 14 | 21 |
| 5 | 731617105052 | THAMIZHSELVAN R | EEE | 9 | 11 | 20 |
| 6 | 731617105021 | C LOGESWARN | MTRE | 14 | 5 | 19 |
| 7 | 731617105003 | BALAJI S | EEE | 8 | 10 | 18 |
| 8 | 731617105017 | M.KARTHIKEYAN | EEE | 6 | 12 | 18 |
| 9 | 731617105022 | M.MANJUPRIYA | EEE | 14 | 4 | 18 |
| 10 | 731617105050 | surya.p | EEE | 14 | 4 | 18 |
| 11 | 1592787 | KAMALAHASAN G | EEE | 9 | 8 | 17 |
| 12 | 731617105033 | RAJAT KUMAR | EEE | 14 | 3 | 17 |
| 13 | 731617105004 | Bharath.S | EEE | 12 | 4 | 16 |
| 14 | 731617105008 | S. P. GOWTHAM | EEE | 9 | 7 | 16 |
| 15 | 731617105013 | Jeevanandam T | EEE | 12 | 4 | 16 |
| 16 | 731617105020 | S.Kirubakar | 3EE-A1 | 9 | 7 | 16 |
| 17 | 731617105037 | K.SANTHOSHKUMAR | EEE | 10 | 6 | 16 |
| 18 | 731617105054 | VENKATESAN.M | EEE | 13 | 3 | 16 |
| 19 | 731617105005 | Dinesh C | EEE | 9 | 6 | 15 |
| 20 | 731617105036 | sakthivel.p | EEE | 12 | 3 | 15 |
| 21 | 731617105049 | Suresh.p | EEE | 3 | 12 | 15 |
| 22 | 1592789 | KAVINKUMAR M | EE | 3 | 10 | 13 |
| 23 | 731617105019 | KAVIN MUTHU KUMAR | EEE | 11 | 2 | 13 |
| 24 | 731617104004 | Arun | CSE | 8 | 5 | 13 |
| 25 | 731617104012 | DINESHKUMAR K | CSE | 8 | 5 | 13 |
| 26 | 731617104020 | harish | CSE | 6 | 7 | 13 |
| 27 | 731617105035 | RAMYA.P | EEE | 11 | 1 | 12 |
| 28 | 731617105041 | SELVAM.B | EEE | 4 | 8 | 12 |
| 29 | 731617105002 | ASHA R | EEE | 3 | 8 | 11 |
| 30 | 731617105031 | PRAVEEN KUMARA | EEE | 10 | 1 | 11 |
| 31 | 731617105042 | shameer.s | EEE | 6 | 5 | 11 |
| 32 | 731617104031 | N.MOHANAPREYA | CSE | 4 | 7 | 11 |
| 33 | 731617105014 | JEEVITHA G | EEC | 6 | 4 | 10 |
| 34 | 731617105025 | NANDAKUMAARAN S | EEE | 5 | 5 | 10 |

| S No | College ID | Name | Branch | Number System | ,Odd man out, Analogy | Total |
|------|--------------|-------------------------|--------|---------------|--------------------------|-------|
| 35 | 731617105044 | Shyam Prashad S | EEE | 2 | 8 | 10 |
| 36 | 731617105045 | S SILAMBARASAN | EEE | 6 | 4 | 10 |
| 37 | 731617104005 | Babu | CSE | 7 | 3 | 10 |
| 38 | 731617105047 | Sujith.S | EEE | 6 | 4 | 10 |
| 39 | 731617105001 | arul m | EEE | 4 | 5 | 9 |
| 40 | 731617105032 | M.PRAVEEN KUMAR | EEE | 5 | 4 | 9 |
| 41 | 731617105009 | guganesh.r | EEE | 5 | 3 | 8 |
| 42 | 731617104007 | S.B chowmiya | CSE | 5 | 3 | 8 |
| 43 | 731617104015 | M.GAYATHRI | CSE | 4 | 4 | 8 |
| 44 | 731617105010 | hari s.r | EEE | 4 | 3 | 7 |
| 45 | 731617105012 | JAYASURYA K | EEE | 4 | 3 | 7 |
| 46 | 731617105038 | saransarvesh m | EEE | 3 | 4 | 7 |
| 47 | 731617105046 | S.SUJITH | EEE | 4 | 3 | 7 |
| 48 | 731617106022 | HARISHKUMAR.R | ECE | 5 | 2 | 7 |
| 49 | 731617105028 | T.PERARIVU EZHIL ARASAN | EEE | 4 | 2 | 6 |
| 50 | 1592806 | SASIKUMAR C | EEE | 5 | 1 | 6 |
| 51 | 731617105055 | Vinoth Kumar | EEE | 0 | 5 | 5 |
| 52 | 731617104016 | GOWTHAM G | CSE | 1 | 4 | 5 |
| 53 | 731617104021 | kailash | CSE | 2 | 3 | 5 |
| 54 | 731617104024 | kishor.p | CSE | 4 | 1 | 5 |
| 55 | 731617106074 | SUDHA.G | ECE | 4 | 0 | 4 |
| 56 | 731617105027 | PARAMASIVAM R | EEE | 0 | 3 | 3 |
| 57 | 731617105048 | K.SUPRIYA | EEE | 1 | 2 | 3 |
| 58 | 731617104014 | M.Gayathri | CSE | 1 | 2 | 3 |
| 59 | 731617105024 | MOHAN T | EEE | 1 | 1 | 2 |

 PRINCIPAL,
 K. S. R. INSTITUTE FOR
 ENGINEERING AND TECHNOLOGY,
 K. S. R. KALVIYALUR,
 TRICHENGODE - 637 215,
 NAMAKKAL DI, TAMIL NADU.

TRAINING AND PLACEMENT CELL

Day 2 - Batch2 - Assessment Report by FACE Trainers

Batch:2017 -2021

Academic Year : 2019 - 2020

| S No | College ID | Name | Department | Number System | Time,speed and distance | Total |
|------|---------------|----------------------|------------|---------------|-------------------------|-------|
| 1 | 731617205010 | GIRINATH S | IT | 15 | 5 | 20 |
| 2 | 731617104013 | Elango.M | CSE | 12 | 6 | 18 |
| 3 | 731617104037 | Prakash V | CSE | 14 | 4 | 18 |
| 4 | 731617205007 | Dhinakaran.K | IT | 6 | 11 | 17 |
| 5 | 731617205033 | NAVEEN KUMAR.G | IT | 10 | 7 | 17 |
| 6 | 731617104046 | Sneha.P | CSE | 7 | 9 | 16 |
| 7 | 731617104026 | Krishnamoorthy.S | CSE | 8 | 7 | 15 |
| 8 | 731617104055 | vijay.s | CSE | 8 | 7 | 15 |
| 9 | 731617104058 | Yuvashree .R | CSE | 6 | 8 | 14 |
| 10 | 731617205039 | SAANTHOSH BALAJI S.N | IT | 2 | 12 | 14 |
| 11 | 731617104027 | M.MANORANJITH | CSE | 10 | 4 | 14 |
| 12 | 731617104054 | VIGNESH S | CSE | 11 | 3 | 14 |
| 13 | 7316172 | ajay sriram .k | IT | 11 | 3 | 14 |
| 14 | 17ietit018 | kalidass | IT | 8 | 5 | 13 |
| 15 | 731617205027 | Mounish | IT | 5 | 7 | 12 |
| 16 | 731617205025 | Lakshmanan R | IT | 8 | 4 | 12 |
| 17 | 731617104028 | R.Marimuthu | CSE | 9 | 3 | 12 |
| 18 | 1592894 | Prasanth.T | CSE | 6 | 6 | 12 |
| 19 | 731617205016 | JOTHEESWARAN R | CSE | 9 | 3 | 12 |
| 20 | 731617205030 | S.NANDHINI | IT | 7 | 4 | 11 |
| 21 | 731617205051 | THANESSHWARAN YG | IT | 6 | 5 | 11 |
| 22 | 731617205013 | HARIPRASATH K | IT | 8 | 3 | 11 |
| 23 | 731617205044 | SATHISHKUMAR V | IT | 5 | 5 | 10 |
| 24 | 2731617104025 | koteeshwaran P.N | CSE | 5 | 5 | 10 |
| 25 | 731617205003 | BABU | IT | 6 | 4 | 10 |
| 26 | 731617205036 | priyadharshini p | IT | 7 | 3 | 10 |
| 27 | 731617104045 | Sharmila.A | CSE | 6 | 4 | 10 |
| 28 | 731617104042 | M.Sangeetha | CSE | 7 | 3 | 10 |
| 29 | 731617205035 | pavithra s | IT | 6 | 3 | 9 |

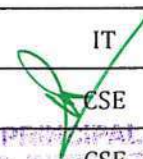
 PRINCIPAL,
 K S R INSTITUTE FOR
 ENGINEERING AND TECHNOLOGY,
 K. S. R. ROAD,
 TIRUCHENGODE - 637 213,
 NAMAKKAL Dt, TAMIL NADU.

| S No | College ID | Name | Department | Number System | Time,speed and distance | Total |
|------|--------------|-----------------------------|------------|---------------|-------------------------|-------|
| 30 | 731617205055 | VINOTHINI R | IT | 6 | 3 | 9 |
| 31 | 731617104051 | Valenteena Collins J Prince | CSE | 4 | 5 | 9 |
| 32 | 731617205048 | SIVASANKARIR | IT | 4 | 4 | 8 |
| 33 | 731617205042 | saran v | IT | 4 | 4 | 8 |
| 34 | 731617104052 | S.Veeralakshmi | CSE | 3 | 5 | 8 |
| 35 | 731617104034 | Pooja M | CSE | 4 | 4 | 8 |
| 36 | 731617205004 | S.BALAMURUGAN | 3IT-2 | 6 | 2 | 8 |
| 37 | 731617205019 | KNNAN P | IT | 5 | 3 | 8 |
| 38 | 731617205046 | shailaa.p.m | IT | 3 | 4 | 7 |
| 39 | 731617205002 | ARULMOZHI M | IT | 6 | 1 | 7 |
| 40 | 731617104035 | K. Pooja shree | CSE | 3 | 4 | 7 |
| 41 | 731617205053 | venkateshwaran s | IT | 4 | 3 | 7 |
| 42 | 731617104040 | purusothaman R | CSE | 7 | 0 | 7 |
| 43 | 17ietit031 | Nathiya.V | IT | 5 | 1 | 6 |
| 44 | 731617205045 | selvamalar p | IT | 3 | 3 | 6 |
| 45 | 731617205049 | SREEMATHI INDRA | IT | 4 | 2 | 6 |
| 46 | 731617104029 | Menaga.T | CSE | 3 | 3 | 6 |
| 47 | 731617104050 | VAISHNAVI.V | CSE | 3 | 3 | 6 |
| 48 | 731617205052 | Thusmeena K.R. | IT | 3 | 2 | 5 |
| 49 | 731617205014 | JESSICA COLLINS J.PRINCE | IT | 3 | 2 | 5 |
| 50 | 731617205047 | N shivani | IT | 1 | 3 | 4 |
| 51 | 731617205011 | GOBIKA M | IT | 2 | 1 | 3 |
| 52 | 731617205040 | SANDHIYA G | IT | 2 | 1 | 3 |
| 53 | 731617104017 | GUNA M | CSE | 1 | 2 | 3 |

PRINCIPAL,
K. S. R. INSTITUTE FOR
ENGINEERING AND TECHNOLOGY,
K. S. R. KALYANAGAR,
TIRUCHENGODE - 637 215,
NAMAKKAL Dt, TAMIL NADU.

K S R INSTITUTE FOR ENGINEERING AND TECHNOLOGY , TIRUCHENGODE - 637215

TRAINING AND PLACEMENT CELL

Day 2 - Batch 3 - Assessment Report by FACE Trainers

Batch:2017 -2021

Academic Year : 2019 - 2020

| S No | College ID | Name | Branch | Coding, Series, VR , Odd man out, Analogy | Time, speed and distance | Total |
|------|------------------|-----------------------------|--------|---|-----------------------------|-------|
| 1 | 731617106017 | GOKULNATH.N | ECE | 6 | 11 | 17 |
| 2 | 731617106020 | HARI HARA SUDHAN. R | ECE | 2 | 12 | 14 |
| 3 | 1592967 | sharumathi.s | ECE | 5 | 8 | 13 |
| 4 | 731617106068 | M.SRIDHARAN | ECE | 5 | 8 | 13 |
| 5 | 731617106050 | PRIYANKA . V | ECE | 7 | 4 | 11 |
| 6 | 1592976/73161710 | SURYAPRIYA.K | ECE | 5 | 6 | 11 |
| 7 | 731617106045 | PARKAVI.P | ECE | 6 | 4 | 10 |
| 8 | 731617106087 | YUVANSANKAR K | ECE | 5 | 5 | 10 |
| 9 | 731617106007 | Booma | ECE | 3 | 6 | 9 |
| 10 | 731617106011 | DHANUSHKODI.N | ECE | 4 | 5 | 9 |
| 11 | 731617106032 | KEERTHIVASAN.N | ECE | 4 | 5 | 9 |
| 12 | 731617106035 | lakshmanan s | ECE | 6 | 3 | 9 |
| 13 | 731617106036 | MADHANGOPAL C | ECE | 1 | 8 | 9 |
| 14 | 731617106038 | Manjula.T | ECE | 5 | 4 | 9 |
| 15 | 731617106042 | NAVEEN.L | ECE | 5 | 4 | 9 |
| 16 | 731617106055 | j.ruban prasad | ECE | 4 | 5 | 9 |
| 17 | 731617106086 | YASODHA P | ECE | 3 | 6 | 9 |
| 18 | 1592921 | R.S.Daranidaran | ECE | 4 | 4 | 8 |
| 19 | 1592922 | Dhanish | ECE | 5 | 3 | 8 |
| 20 | 731617106015 | DINNESH.P | ECE | 4 | 4 | 8 |
| 21 | 731617106025 | JANARTH S | ECE | 5 | 3 | 8 |
| 22 | 731617106028 | KAMALESHWARAN RAVICHANDIRAN | ECE | 4 | 4 | 8 |
| 23 | 731617106029 | N.Kamalini | ECE | 5 | 3 | 8 |
| 24 | 731617106056 | sandhiya.k | ECE | 5 | 3 | 8 |
| 25 | 731617106069 | A.SRINIVASAN | ECE | 4 | 4 | 8 |
| 26 | 1592983/73161710 | UDAYAKUMAR.R | ECE | 5 | 3 | 8 |
| 27 | 731617106012/12 | dharnish k | ECE | 2 | 5 | 7 |
| 28 | 731617106023 | Hemaharini.S | ECE | 1 | 6 | 7 |
| 29 | 731617106043 | NAVEEN. S. S | ECE | 4 | 3 | 7 |
| 30 | 731617106051 | RAGHURAMACHANDIRAN.V | ECE | 3 | 4 | 7 |
| 31 | 731617106058 | SANTHIYA.Y | ECE | 3 | 4 | 7 |
| 32 | 731617106070 | SRINIVASAN.S.R | ECE | 5 | 2 | 7 |
| 33 | 731617106079 | A.sweetlin joshva | ECE | 4 | 3 | 7 |

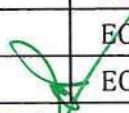
PRINCIPAL,
K. S. R. INSTITUTE FOR
ENGINEERING AND TECHNOLOGY,
K. S. R. KPUN NAGAR,
TIRUCHENGODE - 637 215,
NAMAKKAL DI, TAMIL NADU.

| S No | College ID | Name | Branch | Coding, Series, VR , Odd man out, Analogy | Time, speed and distance | Total |
|------|------------------|-------------------|--------|---|-----------------------------|-------|
| 34 | 1592918 | Anbazhagan.k | ECE | 1 | 5 | 6 |
| 35 | 6381718918 | u.G.DINESH | ECE | 4 | 2 | 6 |
| 36 | 731617106016 | G.GEETHARANI | ECE | 4 | 2 | 6 |
| 37 | 731617106027 | Jawahar Raja.P | ECE | 3 | 3 | 6 |
| 38 | 1592948 | MERIN KUMAR L | ECE | 3 | 3 | 6 |
| 39 | 1592950 | muthulakshmi.s | ECE | 4 | 2 | 6 |
| 40 | 1592951 | ARAVINTH R | ECE | 3 | 3 | 6 |
| 41 | 731617106046 | PARKAVI S | ECE | 4 | 2 | 6 |
| 42 | 1592957 | premela | ECE | 4 | 2 | 6 |
| 43 | 731617106057 | SANTHIYA.T | ECE | 4 | 2 | 6 |
| 44 | 1592969 | SREEMATHI.G | ECE | 4 | 2 | 6 |
| 45 | 731617106084 | M.Thiyagu | ECE | 5 | 1 | 6 |
| 46 | 731617106002 | T.ABINAYA | ECE | 4 | 1 | 5 |
| 47 | 1592919 | BALAKUMARAN.N. | ECE | 2 | 3 | 5 |
| 48 | 731617106019 | Gowtham.M | ECE | 2 | 3 | 5 |
| 49 | 731617106024 | S.HEMALATHA | ECE | 2 | 3 | 5 |
| 50 | 731617106030 | C.KARTHIKA | ECE | 4 | 1 | 5 |
| 51 | 731617106033 | KISHOR.M | ECE | 5 | 0 | 5 |
| 52 | 731617106040 | Mushidha sifana.T | ECE | 5 | 0 | 5 |
| 53 | 731617106061 | M M SHANMATHI | ECE | 4 | 1 | 5 |
| 54 | 731617106063 | SINDUJA.K | ECE | 0 | 5 | 5 |
| 55 | 731617106073 | subash k | ECE | 3 | 2 | 5 |
| 56 | 15929775 | SUKHESAN C | ECE | 3 | 2 | 5 |
| 57 | 731617106080 | G P SWETHA | ECE | 2 | 3 | 5 |
| 58 | 731617106081 | TAMILZHAGAN G | ECE | 3 | 2 | 5 |
| 59 | 731617106082 | S.TEJASWINI | ECE | 4 | 1 | 5 |
| 60 | 731617106021 | M.HARIKRISHNAN | ECE | 2 | 2 | 4 |
| 61 | 731617106031 | s.keerthana | ECE | 2 | 2 | 4 |
| 62 | 731617106034 | KISHORE D | ECE | 3 | 1 | 4 |
| 63 | 1592956 | pavithra.T | ECE | 2 | 2 | 4 |
| 64 | 731617106018 | GOKULNATH.R | ECE | 1 | 2 | 3 |
| 65 | 731617106037 | Manimala .R | ECE | 3 | 0 | 3 |
| 66 | 731617106052/159 | RAMYA S | ECE | 1 | 2 | 3 |
| 67 | 731617106059 | k santhosh | ECE | 3 | 0 | 3 |
| 68 | 731617106071 | SRI RANJANI S | ECE | 2 | 1 | 3 |
| 69 | 731617106003 | Alka p | ECE | 1 | 1 | 2 |

 PRINCIPAL,
 K. S. R. INSTITUTE FOR
 ENGINEERING AND TECHNOLOGY,
 K. S. R. KALVI LAGAR,
 TIRUCHENGODE - 637 215,
 NAMAKKAL Dt, TAMIL NADU.

**K S R INSTITUTE FOR ENGINEERING AND TECHNOLOGY
TIRUCHENGODE - 637 215**

TRAINING PROGRAMME FEEDBACK FORM



Name of the Student: KAMALESHWARAN R

Branch: E.C.E

Year / Sem: III / V

1. Name of the Training: CODING & DECODING

2. Name of the Trainer: NIMA

3. Students rating of Trainers: 4/5

| S. No. | Date | Subject | Rating (✓) | | | |
|--------|--------|----------------------|------------|-----------|------|---------|
| | | | Excellent | Very good | Good | Average |
| 1 | 2-7-19 | CODING & DECODING | ✓ | | | |

4. Two positive points about the programme:

*She covered all the topics given
clarifying doubts was clear*

5. Suggestions for improvement:

The time slot was not enough for topic in schedule

Date: 2-7-19

N. K. A.
Signature

**K S R INSTITUTE FOR ENGINEERING AND TECHNOLOGY
TIRUCHENGODE - 637 215**

TRAINING PROGRAMME FEEDBACK FORM



Name of the Student: Tejashini S

Branch: ECE

Year / Sem: III - IV

1. Name of the Training: T, S, D

2. Name of the Trainer: ARAVIND

3. Students rating of Trainers: 4

| S. No. | Date | Subject | Rating (✓) | | | |
|--------|--------|---------|------------|-----------|------|---------|
| | | | Excellent | Very good | Good | Average |
| 1 | 2-7-19 | TSD | | ✓ | | |

4. Two positive points about the programme:

It was interactive and good.

Good at clarify the doubt

5. Suggestions for improvement:

*When they teach, they make us to do the lab
but in the assessment, it is very high level question. It difficult
to answer.*

Date:

Signature

S. Tejashini

**K S R INSTITUTE FOR ENGINEERING AND TECHNOLOGY
TIRUCHENGODE - 637 215**

TRAINING PROGRAMME FEEDBACK FORM



Name of the Student: MUSHIDHA SIFANA T Branch: ECE

Year / Sem: III / V

1. Name of the Training: APPROXIMATION TIME, SPEED & DISTANCE

2. Name of the Trainer: ARAVINDH

3. Students rating of Trainers: GOOD

| S. No. | Date | Subject | Rating (√) | | | |
|--------|---------|---------|------------|-----------|------|---------|
| | | | Excellent | Very good | Good | Average |
| 1 | 2/07/19 | TSD | | | ✓ | |

4. Two positive points about the programme: clarification of doubt by him is good. Teaching method is good.

5. Suggestions for improvement: He should reduce his voice speed (level of speed).

Date: 02/07/19

Mushida
Signature

**K S R INSTITUTE FOR ENGINEERING AND TECHNOLOGY
TIRUCHENGODE - 637 215**

TRAINING PROGRAMME FEEDBACK FORM



Name of the Student: YUVAN SANKAR K Branch: ECE

Year / Sem: III / V

1. Name of the Training: Time, Speed, & Distance

2. Name of the Trainer: ARAVINDH

3. Students rating of Trainers: 4

| S. No. | Date | Subject | Rating (√) | | | |
|--------|--------|---------|------------|-----------|------|---------|
| | | | Excellent | Very good | Good | Average |
| 1 | 2/7/19 | TSD | ✓ | ✓ | | |

4. Two positive points about the programme: Good firm concept.

5. Suggestions for improvement: No comments.

Date: 2/7/19

Yuvan
Signature

**K S R INSTITUTE FOR ENGINEERING AND TECHNOLOGY
TIRUCHENGODE - 637 215**

TRAINING PROGRAMME FEEDBACK FORM



FN

Name of the Student: S.N. Saanthosh Balaji

Branch: B. Tech CIT

Year / Sem: III

1. Name of the Training: FSD

2. Name of the Trainer: Aravindh

3. Students rating of Trainers: 5

| S. No. | Date | Subject | Rating (√) | | | |
|--------|---------|-----------------------------------|------------|-----------|------|---------|
| | | | Excellent | Very good | Good | Average |
| 1 | 21/7/19 | TSD (Time, Speed, Distance) | ✓ | | | |

4. Two positive points about the programme:

* teaching is with
a he tell story its more so nice

5. Suggestions for improvement:

Date: 22/7/19

Santhosh
Signature

**K S R INSTITUTE FOR ENGINEERING AND TECHNOLOGY
TIRUCHENGODE - 637 215**

TRAINING PROGRAMME FEEDBACK FORM



Name of the Student: N. Prakash

Branch: BE. CSE

Year / Sem: III / V

1. Name of the Training: Placement training

2. Name of the Trainer: Aravindh

3. Students rating of Trainers:

| S. No. | Date | Subject | Rating (√) | | | |
|--------|---------|-----------------------------------|------------|-----------|------|---------|
| | | | Excellent | Very good | Good | Average |
| 1 | 21/7/19 | TSD (Time, Speed, Distance) | | ✓ | | |

4. Two positive points about the programme:

* Gained knowledge about time, speed and dist
* IT was more fun when it is

5. Suggestions for improvement:

* Improve the material

Date: 21/7/19

N. Prakash
Signature

TIRUCHENGODE - 637 215,
KARAKKAL DL, TAMIL NADU.

**K S R INSTITUTE FOR ENGINEERING AND TECHNOLOGY
TIRUCHENGODE - 637 215**

TRAINING PROGRAMME FEEDBACK FORM



FN

Name of the Student: Jessica Collins J Prince

Branch: IT

Year / Sem: III / V

1. Name of the Training: Aptitude training

2. Name of the Trainer: Arun, Aravind

3. Students rating of Trainers :

| S. No. | Date | Subject | Rating (√) | | | |
|--------|----------|---|------------|-----------|------|---------|
| | | | Excellent | Very good | Good | Average |
| 1 | 02.07.19 | Quantum (Arithmetic and Speed, time & distance) | ✓ | | | |

4. Two positive points about the programme: class was interactive and went live with activities

5. Suggestions for improvement: -

Date: 2.7.19

Signature

**K S R INSTITUTE FOR ENGINEERING AND TECHNOLOGY
TIRUCHENGODE - 637 215**

TRAINING PROGRAMME FEEDBACK FORM



Name of the Student: P.N. KOTEESHWARAN

Branch: CSE

Year / Sem: III / V

1. Name of the Training: Aptitude Training

2. Name of the Trainer: Arun, Aravind

3. Students rating of Trainers :

| S. No. | Date | Subject | Rating (√) | | | |
|--------|----------|--|------------|-----------|------|---------|
| | | | Excellent | Very good | Good | Average |
| 1 | 02.07.19 | Quantum Arithmetic, speed and distance | | ✓ | | |

4. Two positive points about the programme: Excellent and good.

5. Suggestions for improvement: we want more conceptual explanation using simple tricks.

Date: 2.7.19

Signature

**K S R INSTITUTE FOR ENGINEERING AND TECHNOLOGY
TIRUCHENGODE - 637 215**

TRAINING PROGRAMME FEEDBACK FORM



Name of the Student: P.N. KOTEESHWARAN Branch: CSE

Year / Sem: III / V

1. Name of the Training : Apptitude Training.

2. Name of the Trainer : Arun.

3. Students rating of Trainers : 4

| S. No. | Date | Subject | Rating (√) | | | |
|--------|----------|--|------------|-----------|------|---------|
| | | | Excellent | Very good | Good | Average |
| 1 | 21/07/19 | Number System. * power cycle * complex Numbers | | ✓ | | |

4. Two positive points about the programme: Many simple tricks are given to solve the questions.

5. Suggestions for improvement: -

Date: 21/07/19.

P.N. Koteeshwaran
Signature

**K S R INSTITUTE FOR ENGINEERING AND TECHNOLOGY
TIRUCHENGODE - 637 215**

TRAINING PROGRAMME FEEDBACK FORM



Name of the Student: K.R. Thusmeena Branch: IT

Year / Sem: III / IV

1. Name of the Training : Apptitude Training

2. Name of the Trainer : Arun

3. Students rating of Trainers : 5

| S. No. | Date | Subject | Rating (√) | | | |
|--------|----------|---------------|------------|-----------|------|---------|
| | | | Excellent | Very good | Good | Average |
| 1 | 21/07/19 | Number System | ✓ | | | |

4. Two positive points about the programme: He thought many logic ideas and steps are given to solve the problem. The class is very interesting.

5. Suggestions for improvement: -

Date: 02/07/19.

K.R. Thusmeena
Signature

**K S R INSTITUTE FOR ENGINEERING AND TECHNOLOGY
TIRUCHENGODE - 637 215**

TRAINING PROGRAMME FEEDBACK FORM



Name of the Student: Tamirahselvan

Branch: JEE

Year / Sem: III / V

1. Name of the Training: NUMBER SYSTEM

2. Name of the Trainer: ARUN

3. Students rating of Trainers: Very Good

| S. No. | Date | Subject | Rating (√) | | | |
|--------|--------|---------------|------------|-----------|------|---------|
| | | | Excellent | Very good | Good | Average |
| 1 | 2/7/19 | Number system | ✓ | | | |

4. Two positive points about the programme: Teaching us smart method to solve.

5. Suggestions for improvement: All Practise Problems can solve

Date:

Signature

**K S R INSTITUTE FOR ENGINEERING AND TECHNOLOGY
TIRUCHENGODE - 637 215**

TRAINING PROGRAMME FEEDBACK FORM



Name of the Student: JEEVANANDAM T

Branch: EEE

Year / Sem: IIA / 05

1. Name of the Training: Number System

2. Name of the Trainer: ARUN

3. Students rating of Trainers: Excellence

| S. No. | Date | Subject | Rating (√) | | | |
|--------|--------|---------------|------------|-----------|------|---------|
| | | | Excellent | Very good | Good | Average |
| 1 | 2/7/19 | NUMBER SYSTEM | ✓ | | | |

4. Two positive points about the programme: ★ Gained a clear view on basis which is useful for problem solving

5. Suggestions for improvement:

Date:

Signature

K. S. R. INSTITUTE FOR
ENGINEERING AND TECHNOLOGY,
K. S. R. KALVI NAGAR,
TIRUCHENGODE - 637 215,
NAMAKKAL DI, TAMIL NADU.

**K S R INSTITUTE FOR ENGINEERING AND TECHNOLOGY
TIRUCHENGODE - 637 215**

TRAINING PROGRAMME FEEDBACK FORM



Name of the Student: M. SARAN SARVESH

Branch: EEE

Year / Sem: III / V

1. Name of the Training: NUMBER SYSTEM.

2. Name of the Trainer: ARUN

3. Students rating of Trainers: 4

| S. No. | Date | Subject | Rating (√) | | | |
|--------|--------|----------------|------------|-----------|------|---------|
| | | | Excellent | Very good | Good | Average |
| 1 | 2/7/19 | NUMBER SYSTEM. | ✓ | | | |

4. Two positive points about the programme:

It is more useful for us to crack the interviews, & competitive exams.

5. Suggestions for improvement:

Date: 2/7/19.

M. Saran Sarvesh
Signature

**K S R INSTITUTE FOR ENGINEERING AND TECHNOLOGY
TIRUCHENGODE - 637 215**

TRAINING PROGRAMME FEEDBACK FORM



Name of the Student: T. JEEVANANDAM

Branch: EEE

Year / Sem: IV / 05

1. Name of the Training: coding and Decoding

2. Name of the Trainer: Nima

3. Students rating of Trainers: 5

| S. No. | Date | Subject | Rating (√) | | | |
|--------|--------|-------------------|------------|-----------|------|---------|
| | | | Excellent | Very good | Good | Average |
| 1 | 2/7/19 | coding & decoding | ✓ | | | |

4. Two positive points about the programme:

** Logics were gained using with valuable shortcut*

5. Suggestions for improvement:

Date: 2/7/19.

PRINCIPAL,
K. S. R. INSTITUTE FOR
ENGINEERING AND TECHNOLOGY,
K. S. R. KALVI NAGAR,
TIRUCHENGODE - 637 215,
NAMAKKAL DISTRICT, TAMIL NADU.

T. Jeevanandam
Signature

TRAINING AND PLACEMENT CELL

Day 3 - Batch 1 - Assessment Report by FACE Trainers

Batch:2017 -2021

Academic Year : 2019 - 2020

| S No | College ID | Name | Branch | Sentence correction | Articles, Preposition & Interrogatives | Total |
|------|--------------|-------------------------|--------|---------------------|--|-------|
| 1 | 731617105021 | C LOGESWARN | MTRE | 14 | 15 | 29 |
| 2 | 731617105028 | T.PERARIVU EZHIL ARASAN | EEE | 14 | 13 | 27 |
| 3 | 731617104009 | DERIL CHARLESS K | CSE | 14 | 13 | 27 |
| 4 | 731617105012 | JAYASURYA K | EEE | 13 | 13 | 26 |
| 5 | 731617105023 | s.Manoj kumar | EEE | 12 | 13 | 25 |
| 6 | 731617105008 | S. P. GOWTHAM | EEE | 15 | 9 | 24 |
| 7 | 731617105044 | Shyam Prashad S | EEE | 10 | 14 | 24 |
| 8 | 731617105038 | saransarvesh m | EEE | 9 | 13 | 22 |
| 9 | 731617105003 | BALAJI S | EEE | 8 | 13 | 21 |
| 10 | 731617105032 | M.PRAVEEN KUMAR | EEE | 10 | 11 | 21 |
| 11 | 731617105041 | SELVAM.B | EEE | 9 | 12 | 21 |
| 12 | 731617105001 | arul m | EEE | 10 | 10 | 20 |
| 13 | 731617105005 | Dinesh C | EEE | 8 | 12 | 20 |
| 14 | 731617105045 | S SILAMBARASAN | EEE | 5 | 15 | 20 |
| 15 | 731617105004 | Bharath.S | EEE | 11 | 8 | 19 |
| 16 | 731617105019 | KAVIN MUTHU KUMAR | EEE | 9 | 10 | 19 |
| 17 | 731617105047 | Sujith.S | EEE | 10 | 9 | 19 |
| 18 | 731617104015 | M.GAYATHRI | CSE | 7 | 12 | 19 |
| 19 | 731617105002 | ASHA R | EEE | 7 | 11 | 18 |
| 20 | 731617105020 | S.Kirubakar | 3EE-A1 | 4 | 14 | 18 |
| 21 | 731617105042 | shameer.s | EEE | 15 | 3 | 18 |
| 22 | 731617104031 | N.MOHANAPREYA | CSE | 6 | 12 | 18 |
| 23 | 731617104024 | kishor.p | CSE | 3 | 15 | 18 |
| 24 | 731617105025 | NANDAKUMAARAN S | EEE | 3 | 14 | 17 |
| 25 | 731617105048 | K.SUPRIYA | EEE | 7 | 10 | 17 |
| 26 | 731617105049 | Suresh.p | EEE | 4 | 13 | 17 |
| 27 | 731617104016 | GOWTHAM G | CSE | 6 | 11 | 17 |
| 28 | 731617105013 | Jeevanandam T | EEE | 6 | 10 | 16 |
| 29 | 1592787 | KAMALAHASAN G | EEE | 7 | 9 | 16 |
| 30 | 731617105017 | M.KARTHIKEYAN | EEE | 3 | 13 | 16 |
| 31 | 731617105024 | MOHAN T | EEE | 6 | 10 | 16 |
| 32 | 731617104004 | Arun | CSE | 5 | 11 | 16 |
| 33 | 731617104012 | DINESHKUMAR K | CSE | 5 | 11 | 16 |
| 34 | 731617104020 | harish | CSE | 6 | 10 | 16 |
| 35 | 731617104021 | kailash | CSE | 8 | 8 | 16 |
| 36 | 731617105014 | JEEVITHA G | EC | 4 | 11 | 15 |
| 37 | 731617105027 | PARAMASIVAM R | EEE | 4 | 11 | 15 |
| 38 | 1592806 | SASIKUMAR C | EEE | 3 | 12 | 15 |

| S No | College ID | Name | Branch | Sentence correction | Preposition & Interrogatives | Total |
|------|--------------|-----------------|--------|---------------------|------------------------------|-------|
| 39 | 731617105050 | surya.p | EEE | 2 | 13 | 15 |
| 40 | 731617105054 | VENKATESAN.M | EEE | 11 | 4 | 15 |
| 41 | 731617105022 | M.MANJUPRIYA | EEE | 6 | 8 | 14 |
| 42 | 731617105052 | THAMIZHSELVAN R | EEE | 6 | 8 | 14 |
| 43 | 731617104002 | AGILAN R | CSE | 6 | 8 | 14 |
| 44 | 731617105046 | S.SUJITH | EEE | 8 | 6 | 14 |
| 45 | 731617104007 | S.B chowmiya | CSE | 3 | 11 | 14 |
| 46 | 731617105009 | guganesh.r | EEE | 4 | 9 | 13 |
| 47 | 1592789 | KAVINKUMAR M | EE | 4 | 9 | 13 |
| 48 | 731617105031 | PRAVEEN KUMAR.A | EEE | 5 | 8 | 13 |
| 49 | 731617105055 | Vinoth Kumar | EEE | 5 | 8 | 13 |
| 50 | 731617105035 | RAMYA.P | EEE | 4 | 8 | 12 |
| 51 | 731617104005 | Babu | CSE | 5 | 7 | 12 |
| 52 | 731617104008 | DEEPAK KUMAR.J | CSE | 8 | 4 | 12 |
| 53 | 731617105010 | hari s.r | EEE | 2 | 9 | 11 |
| 54 | 731617105036 | sakthivel.p | EEE | 1 | 10 | 11 |
| 55 | 731617104014 | M.Gayathri | CSE | 2 | 9 | 11 |
| 56 | 731617105037 | K.SANTHOSHKUMAR | EEE | 4 | 6 | 10 |
| 57 | 731617105033 | RAJAT KUMAR | EEE | 2 | 4 | 6 |
| 58 | 731617106022 | HARISHKUMAR.R | ECE | 1 | 5 | 6 |
| 59 | 731617106064 | sivasankaran.k | ECE | 4 | 0 | 4 |

 PRINCIPAL,
 K. S. R. INSTITUTE FOR
 ENGINEERING AND TECHNOLOGY,
 K. S. R. KALYANANGAR,
 TIRUCHENGODE - 637 215,
 NAMAKKAL DISTRICT, TAMIL NADU.

TRAINING AND PLACEMENT CELL

Day 3 - Batch2 - Assessment Report by FACE Trainers

Batch:2017 -2021

Academic Year : 2019 - 2020

| S No | College ID | Name | Department | Reading Comprehension | Vocabulary | Total |
|------|--------------|-----------------------------|------------|-----------------------|------------|-------|
| 1 | 731617104050 | VAISHNAVI.V | CSE | 12 | 15 | 27 |
| 2 | 731617205033 | NAVEEN KUMAR.G | IT | 12 | 14 | 26 |
| 3 | 731617104045 | Sharmila.A | CSE | 11 | 15 | 26 |
| 4 | 731617104013 | Elango.M | CSE | 9 | 15 | 24 |
| 5 | 731617104037 | Prakash V | CSE | 15 | 9 | 24 |
| 6 | 731617205013 | HARIPRASATH K | IT | 9 | 15 | 24 |
| 7 | 731617104042 | M.Sangeetha | CSE | 8 | 15 | 23 |
| 8 | 731617104051 | Valenteena Collins J Prince | CSE | 8 | 15 | 23 |
| 9 | 731617205004 | S.BALAMURUGAN | 3IT-2 | 15 | 7 | 22 |
| 10 | 731617205014 | JESSICA COLLINS J.PRINCE | IT | 12 | 9 | 21 |
| 11 | 731617205042 | saran v | IT | 7 | 14 | 21 |
| 12 | 731617104034 | Pooja M | CSE | 9 | 12 | 21 |
| 13 | 7316172 | ajay sriram .k | IT | 6 | 14 | 20 |
| 14 | 731617205010 | GIRINATH S | IT | 5 | 14 | 19 |
| 15 | 731617104035 | K. Pooja shree | CSE | 13 | 6 | 19 |
| 16 | 731617205039 | SAANTHOSH BALAJI S.N | IT | 5 | 14 | 19 |
| 17 | 731617104028 | R.Marimuthu | CSE | 7 | 12 | 19 |
| 18 | 731617104026 | Krishnamoorthy.S | CSE | 8 | 11 | 19 |
| 19 | 731617205046 | shailaa.p.m | IT | 8 | 10 | 18 |
| 20 | 731617205025 | Lakshmanan R | IT | 6 | 12 | 18 |
| 21 | 731617205045 | selvamalar p | IT | 8 | 9 | 17 |
| 22 | 731617205007 | Dhinakaran.K | IT | 11 | 6 | 17 |
| 23 | 731617205003 | BABU | IT | 9 | 8 | 17 |
| 24 | 731617205030 | S.NANDHINI | IT | 12 | 4 | 16 |
| 25 | 17ietit018 | kalidass | IT | 6 | 10 | 16 |
| 26 | 731617104058 | Yuvashree .R | CSE | 9 | 7 | 16 |
| 27 | 731617104054 | VIGNESH S | CSE | 9 | 7 | 16 |
| 28 | 731617104040 | purusothaman R | CSE | 9 | 7 | 16 |
| 29 | 1592894 | Prasanth.T | CSE | 7 | 9 | 16 |

PRINCIPAL,
K. S. R. INSTITUTE FOR
ENGINEERING AND TECHNOLOGY,
K. S. R. KALYANASOBI,
TIRUCHENGODE - 637 215,
NAMAKKAL, DI, TAMIL NADU.

| | | | | | | |
|----|---------------|------------------|-----|---|---|----|
| 30 | 731617205051 | THANESSHWARAN YG | IT | 9 | 7 | 16 |
| 31 | 731617205011 | GOBIKA M | IT | 9 | 6 | 15 |
| 32 | 731617205052 | Thusmeena K.R. | IT | 7 | 8 | 15 |
| 33 | 731617205048 | SIVASANKARI.R | IT | 7 | 8 | 15 |
| 34 | 731617104052 | S.Veeralakshmi | CSE | 8 | 7 | 15 |
| 35 | 17ietit031 | Nathiya.V | IT | 7 | 7 | 14 |
| 36 | 731617205021 | KARTHIK.T | IT | 6 | 8 | 14 |
| 37 | 731617104017 | GUNA M | CSE | 5 | 9 | 14 |
| 38 | 731617104046 | Sneha.P | CSE | 7 | 7 | 14 |
| 39 | 1592895 | Santhoshkumar A | CSE | 6 | 8 | 14 |
| 40 | 731617205016 | JOTHEESWARAN R | CSE | 7 | 7 | 14 |
| 41 | 731617205047 | N shivani | IT | 8 | 5 | 13 |
| 42 | 731617205049 | SREEMATHI INDRA | IT | 9 | 4 | 13 |
| 43 | 731617205055 | VINOTHINI R | IT | 6 | 7 | 13 |
| 44 | 731617205040 | SANDHIYA G | IT | 9 | 4 | 13 |
| 45 | 731617205044 | SATHISHKUMAR V | IT | 6 | 7 | 13 |
| 46 | 731617205019 | KNNAN P | IT | 8 | 5 | 13 |
| 47 | 731617205002 | ARULMOZHI M | IT | 7 | 5 | 12 |
| 48 | 731617205027 | Mounish | IT | 3 | 8 | 11 |
| 49 | 731617104013 | Elango.M | CSE | 6 | 5 | 11 |
| 50 | 731617205036 | priyadharshini p | IT | 7 | 4 | 11 |
| 51 | 731617205035 | pavithra s | IT | 6 | 4 | 10 |
| 52 | 2731617104025 | koteeshwaran P.N | CSE | 8 | 2 | 10 |
| 53 | 731617104029 | Menaga.T | CSE | 2 | 6 | 8 |
| 54 | 731617205053 | venkateshwaran s | IT | 0 | 2 | 2 |

PRINCIPAL,
K. S. R. INSTITUTE FOR
ENGINEERING AND TECHNOLOGY,
K. S. R. KALYAN NAGAR,
TIRUCHENGODE - 637 215,
NAMAKKAL Dt, TAMIL NADU.

K S R INSTITUTE FOR ENGINEERING AND TECHNOLOGY , TIRUCHENGODE - 637215

TRAINING AND PLACEMENT CELL

Day 3 - Batch 3 - Assessment Report by FACE Trainers

Batch:2017 -2021

Academic Year : 2019 - 2020

| S No | College ID | Name | Branch | Sentence Completion & Para Jumbles | DI AND DS | Total |
|------|------------------|-----------------------------|--------|------------------------------------|-----------|-------|
| 1 | 731617106028 | KAMALESHWARAN RAVICHANDIRAN | ECE | 12 | 15 | 27 |
| 2 | 731617106033 | KISHOR.M | ECE | 13 | 13 | 26 |
| 3 | 731617106012/12 | dharnish k | ECE | 10 | 15 | 25 |
| 4 | 731617106019 | Gowtham.M | ECE | 10 | 15 | 25 |
| 5 | 731617106017 | GOKULNATH.N | ECE | 14 | 10 | 24 |
| 6 | 1592967 | sharumathi.s | ECE | 10 | 14 | 24 |
| 7 | 731617106086 | YASODHA P | ECE | 10 | 13 | 23 |
| 8 | 731617106003 | Alka p | ECE | 9 | 13 | 22 |
| 9 | 731617106024 | S.HEMALATHA | ECE | 10 | 12 | 22 |
| 10 | 731617106038 | Manjula.T | ECE | 9 | 13 | 22 |
| 11 | 731617106040 | Mushidha sifana.T | ECE | 9 | 13 | 22 |
| 12 | 731617106015 | DINNESH.P | ECE | 12 | 8 | 20 |
| 13 | 731617106021 | M.HARIKRISHNAN | ECE | 10 | 10 | 20 |
| 14 | 731617106025 | JANARTH S | ECE | 9 | 11 | 20 |
| 15 | 731617106031 | s.keerthana | ECE | 7 | 13 | 20 |
| 16 | 731617106071 | SRI RANJANI S | ECE | 9 | 11 | 20 |
| 17 | 731617106029 | N.Kamalini | ECE | 8 | 11 | 19 |
| 18 | 731617106068 | M.SRIDHARAN | ECE | 8 | 11 | 19 |
| 19 | 731617106016 | G.GEETHARANI | ECE | 7 | 11 | 18 |
| 20 | 731617106023 | Hemaharini.S | ECE | 8 | 10 | 18 |
| 21 | 1592948 | MERIN KUMAR L | ECE | 9 | 9 | 18 |
| 22 | 731617106045 | PARKAVI.P | ECE | 6 | 12 | 18 |
| 23 | 731617106050 | PRIYANKA . V | ECE | 9 | 9 | 18 |
| 24 | 731617106018 | GOKULNATH.R | ECE | 12 | 5 | 17 |
| 25 | 731617106035 | lakshmanan s | ECE | 7 | 10 | 17 |
| 26 | 1592950 | muthulakshmi.s | ECE | 6 | 11 | 17 |
| 27 | 731617106059 | k santhosh | ECE | 12 | 5 | 17 |
| 28 | 731617106070 | SRINIVASAN.S.R | ECE | 5 | 12 | 17 |
| 29 | 1592976/73161710 | SURYAPRIYA.K | ECE | 7 | 10 | 17 |
| 30 | 731617106078 | SUSHMITHA.A | ECE | 10 | 7 | 17 |
| 31 | 731617106082 | S.TEJASWINI | ECE | 10 | 7 | 17 |
| 32 | 731617106084 | M.Thiyagu | ECE | 5 | 12 | 17 |
| 33 | 1592921 | R.S.Daranidaran | ECE | 7 | 9 | 16 |

 PRINCIPAL,
 K. S. R. INSTITUTE FOR
 ENGINEERING AND TECHNOLOGY,
 K. S. R. KALMIYAR, 1000,
 TIRUCHENGODE - 637 215,
 NAMAKKAL DC, TAMIL NADU.

| | | | | | | |
|----|------------------|----------------------|-----|----|----|----|
| 34 | 731617106061 | M M SHANMATHI | ECE | 9 | 7 | 16 |
| 35 | 731617106079 | A.sweetlin joshva | ECE | 6 | 10 | 16 |
| 36 | 1592956 | pavithra.T | ECE | 7 | 8 | 15 |
| 37 | 731617106052/159 | RAMYA S | ECE | 8 | 7 | 15 |
| 38 | 731617106081 | TAMILZHAGAN G | ECE | 6 | 9 | 15 |
| 39 | 731617106002 | T.ABINAYA | ECE | 8 | 6 | 14 |
| 40 | 731617106034 | KISHORE D | ECE | 8 | 6 | 14 |
| 41 | 731617106058 | SANTHIYA.Y | ECE | 11 | 3 | 14 |
| 42 | 731617106032 | KEERTHIVASAN.N | ECE | 8 | 5 | 13 |
| 43 | 731617106037 | Manimala .R | ECE | 10 | 3 | 13 |
| 44 | 731617106063 | SINDUJA.K | ECE | 5 | 8 | 13 |
| 45 | 731617106080 | G P SWETHA | ECE | 8 | 5 | 13 |
| 46 | 731617106027 | Jawahar Raja.P | ECE | 3 | 9 | 12 |
| 47 | 1592951 | ARAVINTH R | ECE | 1 | 11 | 12 |
| 48 | 731617106055 | j.ruban prasad | ECE | 6 | 6 | 12 |
| 49 | 1592918 | Anbazhagan.k | ECE | 3 | 8 | 11 |
| 50 | 731617106011 | DHANUSHKODI.N | ECE | 7 | 4 | 11 |
| 51 | 731617106030 | C.KARTHIKA | ECE | 7 | 4 | 11 |
| 52 | 731617106036 | MADHANGOPAL C | ECE | 8 | 3 | 11 |
| 53 | 731617106042 | NAVEEN.L | ECE | 7 | 4 | 11 |
| 54 | 731617106046 | PARKAVI S | ECE | 8 | 3 | 11 |
| 55 | 731617106051 | RAGHURAMACHANDIRAN.V | ECE | 6 | 5 | 11 |
| 56 | 731617106069 | A.SRINIVASAN | ECE | 6 | 5 | 11 |
| 57 | 731617106073 | subash k | ECE | 7 | 3 | 10 |
| 58 | 731617106087 | YUVANSANKAR K | ECE | 7 | 3 | 10 |
| 59 | 731617106007 | Booma | ECE | 7 | 2 | 9 |
| 60 | 6381718918 | u.G.DINESH | ECE | 6 | 3 | 9 |
| 61 | 1592919 | BALAKUMARAN.N. | ECE | 6 | 2 | 8 |
| 62 | 731617106020 | HARI HARA SUDHAN. R | ECE | 5 | 3 | 8 |
| 63 | 731617106043 | NAVEEN. S. S | ECE | 5 | 3 | 8 |
| 64 | 1592969 | SREEMATHI.G | ECE | 5 | 3 | 8 |
| 65 | 1592922 | Dhanish | ECE | 4 | 3 | 7 |
| 66 | 731617106056 | sandhiya.k | ECE | 7 | 0 | 7 |
| 67 | 15929775 | SUKHESAN C | ECE | 6 | 1 | 7 |
| 68 | 1592957 | premela | ECE | 5 | 1 | 6 |
| 69 | 731617106057 | SANTHIYA.T | ECE | 1 | 5 | 6 |

K. S. R. ENGINEERING COLLEGE
ENGINEERING COLLEGE
K. S. R. ENGINEERING COLLEGE
T. CHENNAI - 607 216,
NANDIAL DI, TAMIL NADU.

**K S R INSTITUTE FOR ENGINEERING AND TECHNOLOGY
TIRUCHENGODE - 637 215**

TRAINING PROGRAMME FEEDBACK FORM



Name of the Student: A. Manikandan Branch: IT

Year / Sem: 10 / 1

1. Name of the Training: Vocabulary

2. Name of the Trainer: Ms. Sabarna

3. Students rating of Trainers :

| S. No. | Date | Subject | Rating (√) | | | |
|--------|--------|------------|------------|-----------|------|---------|
| | | | Excellent | Very good | Good | Average |
| 1 | 3.7.19 | vocabulary | ✓ | | | |

4. Two positive points about the programme:

5. Suggestions for improvement:

Date: 3.7.19

A. Manikandan
Signature

**K S R INSTITUTE FOR ENGINEERING AND TECHNOLOGY
TIRUCHENGODE - 637 215**

TRAINING PROGRAMME FEEDBACK FORM



Name of the Student: A. Manikandan Branch: IT

Year / Sem: 10 / 1

1. Name of the Training: Reading comprehension

2. Name of the Trainer: ~~Vocabulary~~ ms. Tsasa

3. Students rating of Trainers :

| S. No. | Date | Subject | Rating (√) | | | |
|--------|--------|---------|------------|-----------|------|---------|
| | | | Excellent | Very good | Good | Average |
| 1 | 3.7.19 | | | ✓ | | |

4. Two positive points about the programme:

5. Suggestions for improvement:

Date: 3.7.19

PRINCIPAL,
K. S. R. INSTITUTE FOR
ENGINEERING AND TECHNOLOGY,
K. S. R. KALVI NAGAR,
TIRUCHENGODE - 637 215,
NAMAKKAL Dt, TAMIL NADU.

A. Manikandan
Signature

**K S R INSTITUTE FOR ENGINEERING AND TECHNOLOGY
TIRUCHENGODE - 637 215**

TRAINING PROGRAMME FEEDBACK FORM



Name of the Student: S. NANDAKUMARAN Branch: BE - EEE

Year / Sem: IV / V

1. Name of the Training: SENTANCE CORRECTION

2. Name of the Trainer: SUBARNA

3. Students rating of Trainers :

| S. No. | Date | Subject | Rating (√) | | | |
|--------|----------|---------------------|------------|-----------|------|---------|
| | | | Excellent | Very good | Good | Average |
| 1 | 03/07/19 | Sentance correction | | | ✓ | |

4. Two positive points about the programme:

5. Suggestions for improvement: Solve the all exercise problem

Date: 03-07-2019

S. Nandakumar
Signature

**K S R INSTITUTE FOR ENGINEERING AND TECHNOLOGY
TIRUCHENGODE - 637 215**

TRAINING PROGRAMME FEEDBACK FORM



Name of the Student: M. Gayathri Branch: BE, CSE

Year / Sem: III / IV

1. Name of the Training: SENTENCE CORRECTION.

2. Name of the Trainer: SUBARNA.

3. Students rating of Trainers :

| S. No. | Date | Subject | Rating (√) | | | |
|--------|----------|---------------------|------------|-----------|------|---------|
| | | | Excellent | Very good | Good | Average |
| 1 | 03.07.19 | Sentence Correction | | ✓ | | |

4. Two positive points about the programme: Good interactive and easy to catch her points.

5. Suggestions for improvement:

Date: 03.07.2019

M. Gayathri
Signature

PRINCIPAL,
K. S. R. INSTITUTE FOR
ENGINEERING AND TECHNOLOGY,
K. S. R. KALVIKANGAR,
TIRUCHENGODE - 637 215,
NAMAKKAL Dt, TAMIL NADU.

**K S R INSTITUTE FOR ENGINEERING AND TECHNOLOGY
TIRUCHENGODE - 637 215**

TRAINING PROGRAMME FEEDBACK FORM



Name of the Student: K. POOJA SHREE Branch: CSE

Year / Sem: II / IV

1. Name of the Training: Vocabulary

2. Name of the Trainer: Suparna

3. Students rating of Trainers: 05

| S. No. | Date | Subject | Rating (✓) | | | |
|--------|----------|------------|------------|-----------|------|---------|
| | | | Excellent | Very good | Good | Average |
| 1 | 03.07.19 | Vocabulary | ✓ | | | |

4. Two positive points about the programme: very easy to find meaning of new words. Increases vocabulary.

5. Suggestions for improvement: -

Date: 03.07.19

K. Rindya
Signature

**K S R INSTITUTE FOR ENGINEERING AND TECHNOLOGY
TIRUCHENGODE - 637 215**

TRAINING PROGRAMME FEEDBACK FORM



Name of the Student: M. SANGEETHA Branch: CSE

Year / Sem: II / IV

1. Name of the Training: VOCABULARY

2. Name of the Trainer: Suparna

3. Students rating of Trainers: 05

| S. No. | Date | Subject | Rating (✓) | | | |
|--------|----------|------------|------------|-----------|------|---------|
| | | | Excellent | Very good | Good | Average |
| 1 | 03.07.19 | Vocabulary | ✓ | | | |

4. Two positive points about the programme: useful and easy to learn the meaning of different words.

5. Suggestions for improvement: -

Date: 03.07.19

M. Sathya
Signature

PRINCIPAL,
K. S. R. INSTITUTE FOR
ENGINEERING AND TECHNOLOGY,
K. S. P. KALVI NAGAR,
TIRUCHENGODE - 637 215,
NAMAKKAL DISTRICT, TAMIL NADU.

**K S R INSTITUTE FOR ENGINEERING AND TECHNOLOGY
TIRUCHENGODE - 637 215**

TRAINING PROGRAMME FEEDBACK FORM



Name of the Student: DINAKHOMAR U Branch: CSE

Year / Sem: III / V

1. Name of the Training: Sentence completion

2. Name of the Trainer: Suparna

3. Students rating of Trainers: 3

| S. No. | Date | Subject | Rating (✓) | | | |
|--------|---------|---------------------|------------|-----------|------|---------|
| | | | Excellent | Very good | Good | Average |
| 1 | 3.07.19 | Sentence completion | | | | ✓ |

4. Two positive points about the programme:

5. Suggestions for improvement: Way of teaching is boring. It should be improved by using more day

Date: 3.07.19

Signature

**K S R INSTITUTE FOR ENGINEERING AND TECHNOLOGY
TIRUCHENGODE - 637 215**

TRAINING PROGRAMME FEEDBACK FORM



Name of the Student: DINAKHOMAR U Branch: CSE

Year / Sem: III / V

1. Name of the Training: Articles, preposition, & interrogatives

2. Name of the Trainer: Fresh Felix

3. Students rating of Trainers: 5

| S. No. | Date | Subject | Rating (✓) | | | |
|--------|------|---------|------------|-----------|------|---------|
| | | | Excellent | Very good | Good | Average |
| 1 | | | | ✓ | | |

4. Two positive points about the programme:

5. Suggestions for improvement: Good

Date:

**PRINCIPAL,
K. S. R. INSTITUTE FOR
ENGINEERING AND TECHNOLOGY,
K. S. R. KALVI NADAR,
TIRUCHENGODE - 637 215,
NANAICKAL DI, TAMIL NADU.**

Signature

K S R INSTITUTE FOR ENGINEERING AND TECHNOLOGY
TIRUCHENGODE - 637 215

TRAINING PROGRAMME FEEDBACK FORM



Name of the Student: KAMALESHWARAN R

Branch: E.C.E

Year / Sem: III / V

1. Name of the Training : DATA INTERPRETATION

2. Name of the Trainer : INDUMATHI

3. Students rating of Trainers :

| S. No. | Date | Subject | Rating (√) | | | |
|--------|---------------|------------------------|------------|-----------|------|---------|
| | | | Excellent | Very good | Good | Average |
| 1 | 3-7-19 A.M | DATA INTERPRETATION | | | ✓ | |

4. Two positive points about the programme:

Doubts were cleared faster in a understandable manner

5. Suggestions for improvement:

Time management for completion of topics

Date: 3-07-19.

R.K.I
Signature

K S R INSTITUTE FOR ENGINEERING AND TECHNOLOGY
TIRUCHENGODE - 637 215

TRAINING PROGRAMME FEEDBACK FORM



Name of the Student: PARKANI S

Branch: ECE

Year / Sem: III / V

1. Name of the Training : DATA INTERPRETATION

2. Name of the Trainer : INDUMATHI

3. Students rating of Trainers :

| S. No. | Date | Subject | Rating (√) | | | |
|--------|------------|------------------------|------------|-----------|------|---------|
| | | | Excellent | Very good | Good | Average |
| 1 | 3-7-19.A.M | DATA INTERPRETATION | | | ✓ | |

4. Two positive points about the programme:

Teaching interested in short way and cleared doubts easily

5. Suggestions for improvement:

We want more explanation about that topic.

Date: 3-07-19.

[Signature]
Signature

PRINCIPAL,
K. S. R. INSTITUTE FOR
ENGINEERING AND TECHNOLOGY

K S R INSTITUTE FOR ENGINEERING AND TECHNOLOGY
TIRUCHENGODE - 637 215

TRAINING PROGRAMME FEEDBACK FORM



Name of the Student: MADHAN GOPAL . C

Branch: ECE

Year / Sem: III / V

1. Name of the Training : SENTENCE COMPLETION AND PARA - JUMBLES

2. Name of the Trainer : INDUMATHI

3. Students rating of Trainers : 4

| S. No. | Date | Subject | Rating (✓) | | | |
|--------|--------------|---------------------|------------|-----------|------|---------|
| | | | Excellent | Very good | Good | Average |
| 1 | 03/07/19-Fri | SENTENCE COMPLETION | | ✓ | | |

4. Two positive points about the programme:

- ✓) Good in clearing doubts
- ✓) Approaching the question is different

5. Suggestions for improvement:

Date: 03/07/19 - Fri

C. Madhan
Signature

K S R INSTITUTE FOR ENGINEERING AND TECHNOLOGY
TIRUCHENGODE - 637 215

TRAINING PROGRAMME FEEDBACK FORM



Name of the Student: S. Thyagaraj

Branch: ECE

Year / Sem: III / V

1. Name of the Training : INDUMATHI

2. Name of the Trainer : SENTENCE COMPLETION AND PARA - JUMBLES.

3. Students rating of Trainers : 4

| S. No. | Date | Subject | Rating (✓) | | | |
|--------|----------|---------------------|------------|-----------|------|---------|
| | | | Excellent | Very good | Good | Average |
| 1 | 03/07/19 | Sentence completion | | ✓ | | |

4. Two positive points about the programme:

- * Good in clearing doubts with full patience

5. Suggestions for improvement:

- * Got many extra info. beyond the topic

Date: 03/07/19 - Fri
No - Comment.

S. Thyagaraj
Signature

PRINCIPAL,
K. S. R. INSTITUTE FOR
ENGINEERING AND TECHNOLOGY,
K. S. R. HALL NAGAR,
TIRUCHENGODE - 637 215,
NAMAKKAL DI, TAMIL NADU.

Batch:2017 -2021

Academic Year : 2019 - 2020

| S No | College ID | Name | Branch | Time Speed and Distance | Percentage | Total |
|------|--------------|-------------------------|--------|-------------------------|--------------|-------|
| 1 | 731617105005 | Dinesh C | EEE | 12 | 15 | 27 |
| 2 | 731617105017 | M.KARTHIKEYAN | EEE | 11 | 14 | 25 |
| 3 | 731617104004 | Arun | CSE | 12 | 13 | 25 |
| 4 | 1592787 | KAMALAHASAN G | EEE | 10 | 14 | 24 |
| 5 | 731617105019 | KAVIN MUTHU KUMAR | EEE | 10 | 14 | 24 |
| 6 | 731617105044 | Shyam Prashad S | EEE | 10 | 14 | 24 |
| 7 | 731617105047 | Sujith.S | EEE | 9 | 13 | 22 |
| 8 | 731617104009 | DERIL CHARLESS K | CSE | 7 | 15 | 22 |
| 9 | 1592806 | SASIKUMAR C | EEE | 8 | 13 | 21 |
| 10 | 731617105045 | S SILAMBARASAN | EEE | 8 | 13 | 21 |
| 11 | 731617104002 | AGILAN R | CSE | 7 | 14 | 21 |
| 12 | 731617105014 | JEEVITHA G | EC | 6 | 14 | 20 |
| 13 | 731617105041 | SELVAM.B | EEE | 9 | 11 | 20 |
| 14 | 731617105037 | K.SANTHOSHKUMAR | EEE | 6 | 13 | 19 |
| 15 | 731617105022 | M.MANJUPRIYA | EEE | 6 | 12 | 18 |
| 16 | 731617105025 | NANDAKUMAARAN S | EEE | 3 | 15 | 18 |
| 17 | 731617105027 | PARAMASIVAM R | EEE | 5 | 13 | 18 |
| 18 | 731617105035 | RAMYA.P | EEE | 5 | 13 | 18 |
| 19 | 731617105038 | saransarvesh m | EEE | 4 | 14 | 18 |
| 20 | 731617105001 | arul m | EEE | 8 | 9 | 17 |
| 21 | 1592789 | KAVINKUMAR M | EE | 8 | 9 | 17 |
| 22 | 731617104020 | harish | CSE | 9 | 8 | 17 |
| 23 | 731617105004 | Bharath.S | EEE | 6 | 10 | 16 |
| 24 | 731617105028 | T.PERARIVU EZHIL ARASAN | EEE | 6 | 10 | 16 |
| 25 | 731617104007 | S.B chowmiya | CSE | 6 | 10 | 16 |
| 26 | 731617104014 | M.Gayathri | CSE | 6 | 10 | 16 |
| 27 | 731617105021 | C LOGESWARN | MTRE | 12 | 3 | 15 |
| 28 | 731617105050 | surya.p | EEE | 5 | 10 | 15 |
| 29 | 731617105012 | JAYASURYA K | EEE | 6 | 8 | 14 |
| 30 | 731617105020 | S.Kirubakar | 3EE-A1 | 10 | 4 | 14 |
| 31 | 731617105031 | PRAVEEN KUMARA | EEE | 14 | Not Attended | 14 |
| 32 | 731617104031 | N.MOHANAPREYA | CSE | 4 | 10 | 14 |
| 33 | 731617104012 | DINESHKUMAR K | CSE | 6 | 8 | 14 |
| 34 | 731617105002 | ASHA R | EEE | 4 | 9 | 13 |
| 35 | 731617105009 | guganesh.r | EEE | 4 | 9 | 13 |
| 36 | 731617105013 | Jeevanandam T | EEE | 5 | 8 | 13 |

| S No | College ID | Name | Branch | Time Speed and Distance | Percentage | Total |
|------|--------------|-----------------|--------|-------------------------|--------------|-------|
| 37 | 731617105023 | s.Manoj kumar | EEE | 13 | Not Attended | 13 |
| 38 | 731617105024 | MOHAN T | EEE | 4 | 9 | 13 |
| 39 | 731617105032 | M.PRAVEEN KUMAR | EEE | 12 | Not Attended | 12 |
| 40 | 731617104005 | Babu | CSE | 6 | 6 | 12 |
| 41 | 731617105048 | K.SUPRIYA | EEE | 3 | 9 | 12 |
| 42 | 731617104024 | kishor.p | CSE | 6 | 6 | 12 |
| 43 | 731617105008 | S. P. GOWTHAM | EEE | 10 | 1 | 11 |
| 44 | 731617105003 | BALAJI S | EEE | 4 | 5 | 9 |
| 45 | 731617105042 | shameer.s | EEE | 8 | Not Attended | 8 |
| 46 | 731617105055 | Vinoth Kumar | EEE | 1 | 7 | 8 |
| 47 | 731617104008 | DEEPAK KUMAR.J | CSE | 8 | Not Attended | 8 |
| 48 | 731617105054 | VENKATESAN.M | EEE | 4 | 3 | 7 |
| 49 | 731617104016 | GOWTHAM G | CSE | 7 | Not Attended | 7 |
| 50 | 731617104021 | kailash | CSE | 7 | Not Attended | 7 |
| 51 | 731617105049 | Suresh.p | EEE | 5 | Not Attended | 5 |
| 52 | 731617105046 | S.SUJITH | EEE | 5 | Not Attended | 5 |
| 53 | 731617106074 | SUDHA.G | ECE | 5 | Not Attended | 5 |
| 54 | 731617106064 | sivasankaran.k | ECE | 5 | Not Attended | 5 |
| 55 | 731617105033 | RAJAT KUMAR | EEE | 4 | Not Attended | 4 |
| 56 | 731617105010 | hari s.r | EEE | 2 | 1 | 3 |
| 57 | 731617105036 | sakthivel.p | EEE | 3 | Not Attended | 3 |
| 58 | 731617106022 | HARISHKUMAR.R | ECE | 3 | 0 | 3 |

 PRINCIPAL,
 K. S. R. INSTITUTE FOR
 ENGINEERING AND TECHNOLOGY,
 K. S. R. KALU NAGAR,
 TIRUCHENGODE - 637 215,
 NAMAGAL Dt, TAMIL NADU.

TRAINING AND PLACEMENT CELL

Day 5 - Batch2 - Assessment Report by FACE Trainers

Batch:2017 -2021

Academic Year : 2019 - 2020

| S No | College ID | Name | Department | CODING AND DECODING, VISUAL REASONING | Data Arrangement and Blood Relations | Total |
|------|--------------|--------------------------|------------|---------------------------------------|--------------------------------------|-------|
| 1 | 731617104037 | Prakash V | CSE | 15 | 15 | 30 |
| 2 | 731617104027 | M.MANORANJITH | CSE | 15 | 15 | 30 |
| 3 | 731617104054 | VIGNESH S | CSE | 15 | 15 | 30 |
| 4 | 731617104028 | R.Marimuthu | CSE | 15 | 14 | 29 |
| 5 | 1592895 | Santhoshkumar A | CSE | 15 | 14 | 29 |
| 6 | 731617205042 | saran v | IT | 14 | 14 | 28 |
| 7 | 731617205003 | BABU | IT | 15 | 13 | 28 |
| 8 | 731617104052 | S.Veeralakshmi | CSE | 14 | 14 | 28 |
| 9 | 731617104045 | Sharmila.A | CSE | 15 | 13 | 28 |
| 10 | 731617205053 | venkateshwaran s | IT | 15 | 13 | 28 |
| 11 | 1592894 | Prasanth.T | CSE | 13 | 15 | 28 |
| 12 | 731617205026 | A.MANIKANDAN | 3IT-2 | 15 | 13 | 28 |
| 13 | 731617205030 | S.NANDHINI | IT | 15 | 12 | 27 |
| 14 | 731617205014 | JESSICA COLLINS J.PRINCE | IT | 15 | 12 | 27 |
| 15 | 731617205033 | NAVEEN KUMAR.G | IT | 13 | 14 | 27 |
| 16 | 731617104046 | Sneha.P | CSE | 14 | 13 | 27 |
| 17 | 731617104058 | Yuvashree .R | CSE | 13 | 14 | 27 |
| 18 | 731617104035 | K. Pooja shree | CSE | 14 | 13 | 27 |
| 19 | 731617104026 | Krishnamoorthy.S | CSE | 14 | 13 | 27 |
| 20 | 731617205025 | Lakshmanan R | IT | 13 | 13 | 26 |
| 21 | 731617205039 | SAANTHOSH BALAJI S.N | IT | 12 | 14 | 26 |
| 22 | 731617104055 | vijay.s | CSE | 15 | 11 | 26 |
| 23 | 731617205016 | JOTHEESWARAN R | CSE | 15 | 11 | 26 |
| 24 | 731617205027 | Mounish | IT | 13 | 12 | 25 |
| 25 | 731617104040 | purusothaman R | CSE | 15 | 10 | 25 |
| 26 | 731617205051 | THANESSHWARAN YG | IT | 15 | 9 | 24 |
| 27 | 731617205004 | S.BALAMURUGAN | 3IT-2 | 10 | 14 | 24 |
| 28 | 731617205013 | HARIPRASATH K | IT | 10 | 14 | 24 |

| | | | | | | |
|----|---------------|-----------------------------|-----|----|----|----|
| 29 | 731617205002 | ARULMOZHI M | IT | 10 | 13 | 23 |
| 30 | 731617205052 | Thusmeena K.R. | IT | 15 | 8 | 23 |
| 31 | 731617205055 | VINOTHINI R | IT | 14 | 9 | 23 |
| 32 | 731617205007 | Dhinakaran.K | IT | 14 | 9 | 23 |
| 33 | 731617205044 | SATHISHKUMAR V | IT | 14 | 9 | 23 |
| 34 | 731617104017 | GUNA M | CSE | 14 | 9 | 23 |
| 35 | 17ietit018 | kalidass | IT | 13 | 10 | 23 |
| 36 | 731617104050 | VAISHNAVI.V | CSE | 12 | 11 | 23 |
| 37 | 731617104051 | Valenteena Collins J Prince | CSE | 12 | 11 | 23 |
| 38 | 731617205021 | KARTHIK.T | IT | 13 | 9 | 22 |
| 39 | 2731617104025 | koteeshwaran P.N | CSE | 13 | 9 | 22 |
| 40 | 731617205035 | pavithra s | IT | 13 | 8 | 21 |
| 41 | 731617205046 | shailaa.p.m | IT | 12 | 9 | 21 |
| 42 | 731617205048 | SIVASANKARLR | IT | 13 | 8 | 21 |
| 43 | 731617205049 | SREEMATHI INDRA | IT | 12 | 9 | 21 |
| 44 | 731617104013 | Elango.M | CSE | 11 | 10 | 21 |
| 45 | 731617205040 | SANDHIYA G | IT | 11 | 9 | 20 |
| 46 | 731617104042 | M.Sangeetha | CSE | 7 | 13 | 20 |
| 47 | 731617104034 | Pooja M | CSE | 10 | 10 | 20 |
| 48 | 731617104029 | Menaga.T | CSE | 15 | 4 | 19 |
| 49 | 731617205011 | GOBIKA M | IT | 12 | 6 | 18 |
| 50 | 731617205045 | selvamalar p | IT | 7 | 9 | 16 |
| 51 | 7316172 | ajay sriram .k | IT | 10 | 6 | 16 |
| 52 | 731617205010 | GIRINATH S | IT | 8 | 7 | 15 |
| 53 | 731617205019 | KNNAN P | IT | 7 | 7 | 14 |
| 54 | 17ietit031 | Nathiya.V | IT | 8 | 5 | 13 |
| 55 | 731617205036 | priyadarshini p | IT | 11 | 0 | 11 |

PRINCIPAL,
K. S. R. INSTITUTE FOR
ENGINEERING AND TECHNOLOGY,
K. S. R. KALVI NAGAR,
TIRUCHENGODE - 637 215,
NAMAKKAL DISTRICT, TAMIL NADU.

K S R INSTITUTE FOR ENGINEERING AND TECHNOLOGY , TIRUCHENGODE - 637215

TRAINING AND PLACEMENT CELL

Day 4 - Batch 3 - Assessment Report by FACE Trainers

Batch:2017 -2021

Academic Year : 2019 - 2020

| S No | College ID | Name | Branch | Numbers | Profit and Loss, Averages | Total |
|------|------------------|-----------------------------|--------|---------|---------------------------|-------|
| 1 | 731617106028 | KAMALESHWARAN RAVICHANDIRAN | ECE | 14 | 15 | 29 |
| 2 | 731617106012/12 | dharnish k | ECE | 13 | 14 | 27 |
| 3 | 731617106019 | Gowtham.M | ECE | 13 | 13 | 26 |
| 4 | 1592921 | R.S.Daranidaran | ECE | 13 | 11 | 24 |
| 5 | 731617106025 | JANARTH S | ECE | 10 | 14 | 24 |
| 6 | 731617106070 | SRINIVASAN.S.R | ECE | 12 | 11 | 23 |
| 7 | 731617106024 | S.HEMALATHA | ECE | 14 | 8 | 22 |
| 8 | 731617106032 | KEERTHIVASAN.N | ECE | 11 | 11 | 22 |
| 9 | 731617106017 | GOKULNATH.N | ECE | 7 | 14 | 21 |
| 10 | 731617106003 | Alka p | ECE | 12 | 8 | 20 |
| 11 | 731617106038 | Manjula.T | ECE | 12 | 8 | 20 |
| 12 | 1592918 | Anbazhagan.k | ECE | 11 | 8 | 19 |
| 13 | 731617106015 | DINNESH.P | ECE | 11 | 8 | 19 |
| 14 | 731617106058 | SANTHIYA.Y | ECE | 10 | 9 | 19 |
| 15 | 731617106063 | SINDUJA.K | ECE | 10 | 9 | 19 |
| 16 | 731617106068 | M.SRIDHARAN | ECE | 14 | 5 | 19 |
| 17 | 731617106086 | YASODHA P | ECE | 8 | 11 | 19 |
| 18 | 6381718918 | u.G.DINESH | ECE | 12 | 6 | 18 |
| 19 | 731617106023 | Hemaharini.S | ECE | 9 | 9 | 18 |
| 20 | 1592967 | sharumathi.s | ECE | 11 | 7 | 18 |
| 21 | 1592976/73161710 | SURYAPRIYA.K | ECE | 11 | 7 | 18 |
| 22 | 731617106016 | G.GEETHARANI | ECE | 12 | 5 | 17 |
| 23 | 731617106033 | KISHOR.M | ECE | 15 | 2 | 17 |
| 24 | 731617106045 | PARKAVI.P | ECE | 11 | 6 | 17 |
| 25 | 731617106046 | PARKAVIS | ECE | 10 | 7 | 17 |
| 26 | 731617106002 | T.ABINAYA | ECE | 8 | 8 | 16 |
| 27 | 731617106021 | M.HARIKRISHNAN | ECE | 10 | 6 | 16 |
| 28 | 731617106078 | SUSHMITHA.A | ECE | 9 | 7 | 16 |
| 29 | 731617106082 | S.TEJASWINI | ECE | 7 | 9 | 16 |
| 30 | 731617106087 | YUVANSANKAR K | ECE | 10 | 6 | 16 |
| 31 | 731617106029 | N.Kamalini | ECE | 9 | 6 | 15 |
| 32 | 731617106031 | s.keerthana | ECE | 10 | 5 | 15 |

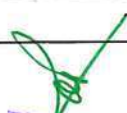
PRINCIPAL,
K. S. R. INSTITUTE FOR
ENGINEERING AND TECHNOLOGY,
K. S. R. KALVI NAGAR,
TIRUCHENGODE - 637 215,
NAMAKKAL DI, TAMIL NADU.

| S No | College ID | Name | Branch | Numbers | Profit and Loss, Averages | Total |
|------|------------------|----------------------|--------|---------|---------------------------|-------|
| 33 | 1592951 | ARAVINTH R | ECE | 8 | 7 | 15 |
| 34 | 1592956 | pavithra.T | ECE | 9 | 6 | 15 |
| 35 | 731617106040 | Mushidha sifana.T | ECE | 10 | 4 | 14 |
| 36 | 1592950 | muthulakshmi.s | ECE | 10 | 4 | 14 |
| 37 | 731617106042 | NAVEEN.L | ECE | 6 | 8 | 14 |
| 38 | 731617106059 | k santhosh | ECE | 3 | 11 | 14 |
| 39 | 731617106079 | A.sweetlin joshva | ECE | 8 | 6 | 14 |
| 40 | 731617106011 | DHANUSHKODI.N | ECE | 9 | 4 | 13 |
| 41 | 731617106020 | HARI HARA SUDHAN. R | ECE | 9 | 4 | 13 |
| 42 | 731617106051 | RAGHURAMACHANDIRAN.V | ECE | 8 | 5 | 13 |
| 43 | 731617106052/159 | RAMYA S | ECE | 6 | 7 | 13 |
| 44 | 731617106055 | j.ruban prasad | ECE | 5 | 8 | 13 |
| 45 | 731617106069 | A.SRINIVASAN | ECE | 11 | 2 | 13 |
| 46 | 15929775 | SUKHESAN C | ECE | 5 | 8 | 13 |
| 47 | 731617106034 | KISHORE D | ECE | 7 | 5 | 12 |
| 48 | 1592948 | MERIN KUMAR L | ECE | 6 | 6 | 12 |
| 49 | 1592957 | premela | ECE | 6 | 6 | 12 |
| 50 | 731617106050 | PRIYANKA . V | ECE | 7 | 5 | 12 |
| 51 | 731617106061 | M M SHANMATHI | ECE | 5 | 7 | 12 |
| 52 | 731617106081 | TAMILZHAGAN G | ECE | 7 | 5 | 12 |
| 53 | 731617106030 | C.KARTHIKA | ECE | 7 | 4 | 11 |
| 54 | 731617106035 | lakshmanan s | ECE | 8 | 3 | 11 |
| 55 | 731617106036 | MADHANGOPAL C | ECE | 5 | 6 | 11 |
| 56 | 731617106080 | G P SWETHA | ECE | 8 | 3 | 11 |
| 57 | 731617106084 | M.Thiyagu | ECE | 6 | 5 | 11 |
| 58 | 731617106018 | GOKULNATH.R | ECE | 4 | 6 | 10 |
| 59 | 731617106071 | SRI RANJANI S | ECE | 5 | 5 | 10 |
| 60 | 731617106073 | subash k | ECE | 7 | 3 | 10 |
| 61 | 1592922 | Dhanish | ECE | 3 | 6 | 9 |
| 62 | 1592919 | BALAKUMARAN.N. | ECE | 4 | 4 | 8 |
| 63 | 731617106007 | Booma | ECE | 3 | 5 | 8 |
| 64 | 731617106043 | NAVEEN. S. S | ECE | 3 | 5 | 8 |
| 65 | 731617106037 | Manimala .R | ECE | 5 | 2 | 7 |
| 66 | 731617106056 | sandhiya.k | ECE | 4 | 3 | 7 |
| 67 | 731617106057 | SANTHIYA.T | ECE | 1 | 4 | 5 |
| 68 | 731617106027 | Jawahar Raja.P | ECE | 1 | 3 | 4 |

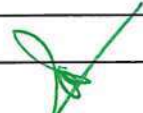
PRINCIPAL,
K. S. R. INSTITUTE FOR
ENGINEERING AND TECHNOLOGY,
K. S. R. KALVI NAGAR,
TIRUCHENGODE - 637 215,
NAMAKKAL DISTRICT, TAMIL NADU.

K S R INSTITUTE FOR ENGINEERING AND TECHNOLOGY
TIRUCHENGODE - 637 215

TRAINING PROGRAMME FEEDBACK FORM



Name of the Student: N. Dhanush Kodi

Branch: FCE

Year / Sem: III / V

1. Name of the Training: Number System

2. Name of the Trainer: Arun

3. Students rating of Trainers: 4/5

| S. No. | Date | Subject | Rating (✓) | | | |
|--------|-----------|---------|------------|-----------|------|---------|
| | | | Excellent | Very good | Good | Average |
| 1 | 4.07.2019 | | | ✓ | | |

4. Two positive points about the programme:

- * It is not like a normal class
- * It is more fun and also the class was interesting

5. Suggestions for improvement:

Don't get angry

Date:

N.R
Signature

K S R INSTITUTE FOR ENGINEERING AND TECHNOLOGY
TIRUCHENGODE - 637 215

TRAINING PROGRAMME FEEDBACK FORM



Name of the Student: Y. SATHIYA

Branch: FCE

Year / Sem: III / V

1. Name of the Training: Number System

2. Name of the Trainer: ARUN

3. Students rating of Trainers: 4/5

| S. No. | Date | Subject | Rating (✓) | | | |
|--------|---------|---------|------------|-----------|------|---------|
| | | | Excellent | Very good | Good | Average |
| 1 | 4.07.19 | | | ✓ | | |

4. Two positive points about the programme:

- More interesting with funny exercise which is useful to our topic.

5. Suggestions for improvement:

Give the example to solve many.

Date: 4/07/19

Y. Sathiya
Signature

K S R INSTITUTE FOR ENGINEERING AND TECHNOLOGY
TIRUCHENGODE - 637 215

TRAINING PROGRAMME FEEDBACK FORM



Name of the Student: M. Gayathri

Branch: CSE - III yr

Year / Sem: III / V

1. Name of the Training: Time, Speed and Distance

2. Name of the Trainer: Aravind

3. Students rating of Trainers :

| S. No. | Date | Subject | Rating (✓) | | | |
|--------|----------|------------------------|------------|-----------|------|---------|
| | | | Excellent | Very good | Good | Average |
| 1 | 04.07.19 | Time, Speed & Distance | | | ✓ | |

4. Two positive points about the programme: learnt about Quants and general topics. Easy way to solve

5. Suggestions for improvement: More examples, Problems

Date: 04.07.2019

M. Gayathri
Signature

K S R INSTITUTE FOR ENGINEERING AND TECHNOLOGY
TIRUCHENGODE - 637 215

TRAINING PROGRAMME FEEDBACK FORM



Name of the Student: S. Balaji

Branch: EEE - III - yr

Year / Sem: III / IV

1. Name of the Training: Time Speed and Distance

2. Name of the Trainer: Aravind

3. Students rating of Trainers :

| S. No. | Date | Subject | Rating (✓) | | | |
|--------|---------|------------------------|------------|-----------|------|---------|
| | | | Excellent | Very good | Good | Average |
| 1 | 04.7.19 | Time, speed & Distance | | | ✓ | |

4. Two positive points about the programme: learn the basic

5. Suggestions for improvement: Need more explanation

Date: 04.07.2019

S. Balaji
Signature

PRINCIPAL,
K. S. R. INSTITUTE FOR
ENGINEERING AND TECHNOLOGY,
K. S. R. KALVINAGAR,
TIRUCHENGODE - 637 215,
NAMAKKAL DI, TAMIL NADU.

**K S R INSTITUTE FOR ENGINEERING AND TECHNOLOGY
TIRUCHENGODE - 637 215**

TRAINING PROGRAMME FEEDBACK FORM



Name of the Student: R. HART HARA SUDHAN Branch: ECE

Year / Sem: III / V

1. Name of the Training: PROFIT AND LOSS

2. Name of the Trainer: Nima

3. Students rating of Trainers: 9.5/10

| S. No. | Date | Subject | Rating (✓) | | | |
|--------|----------|---------|------------|-----------|------|---------|
| | | | Excellent | Very good | Good | Average |
| 1 | 4/7/2019 | | ✓ | | | |

4. Two positive points about the programme:

*Teaching style was good.
She freely clarify our doubts*

5. Suggestions for improvement:

Please, control the students, most of the students making noise. But its our mistake, some of them doesn't make noise, they are getting disturb.

Date: 4/7/2019

R. HART
Signature

**K S R INSTITUTE FOR ENGINEERING AND TECHNOLOGY
TIRUCHENGODE - 637 215**

TRAINING PROGRAMME FEEDBACK FORM



Name of the Student: V. RAGHU Branch: ECE

Year / Sem: III / V

1. Name of the Training: PROFIT AND LOSS

2. Name of the Trainer: Nima

3. Students rating of Trainers: 9.5/10

| S. No. | Date | Subject | Rating (✓) | | | |
|--------|----------|---------|------------|-----------|------|---------|
| | | | Excellent | Very good | Good | Average |
| 1 | 4/7/2019 | | ✓ | | | |

4. Two positive points about the programme:

Class is very good and in interested way

5. Suggestions for improvement:

NO COMMENTS
PRINCIPAL,
ENGINEERING AND TECHNOLOGY,
K. S. R. KALVI NAGAR,
TIRUCHENGODE - 637 215,
NAMAKKAL DI, TAMIL NADU.

Date: 4/7/2019

R. HART
Signature

**K S R INSTITUTE FOR ENGINEERING AND TECHNOLOGY
TIRUCHENGODE - 637 215**

TRAINING PROGRAMME FEEDBACK FORM



Name of the Student: S. Kavinmuthu Kumar Branch: EEE

Year / Sem: 3/5

1. Name of the Training: Time, speed and Distance. Percentage.

2. Name of the Trainer: Arun

3. Students rating of Trainers: 5

| S. No. | Date | Subject | Rating (✓) | | | |
|--------|--------|--------------------------|------------|-----------|------|---------|
| | | | Excellent | Very good | Good | Average |
| 1 | 4.7.19 | Time, speed and Distance | | ✓ | | |

4. Two positive points about the programme:

It was interesting and had lot information.

5. Suggestions for improvement:

Date: 4.7.19

S. Kavinmuthu Kumar
Signature

**K S R INSTITUTE FOR ENGINEERING AND TECHNOLOGY
TIRUCHENGODE - 637 215**

TRAINING PROGRAMME FEEDBACK FORM



Name of the Student: M. SARAN SRINIVAS Branch: EEE

Year / Sem: 3/5

1. Name of the Training: Percentage

2. Name of the Trainer: Arun

3. Students rating of Trainers: 5

| S. No. | Date | Subject | Rating (✓) | | | |
|--------|--------|------------|------------|-----------|------|---------|
| | | | Excellent | Very good | Good | Average |
| 1 | 4/7/19 | Percentage | ✓ | | | |

4. Two positive points about the programme:

It was interesting to learn & earn information about HR round.

5. Suggestions for improvement:

Date: 4/7/19

PRINCIPAL
K. S. R. INSTITUTE FOR
ENGINEERING AND TECHNOLOGY,
K. S. R. NAYAKAR,
TIRUCHENGODE - 637 215,
TAMIL NADU.

M. Saran
Signature

TRAINING AND PLACEMENT CELL

Day 5 - Batch 1 - Assessment Report by FACE Trainers

Batch:2017 -2021

Academic Year : 2019 - 2020

| S No | College ID | Name | Branch | Time Speed and Distance | Percentage | Total |
|------|--------------|-------------------------|--------|-------------------------|--------------|-------|
| 1 | 731617105005 | Dinesh C | EEE | 12 | 15 | 27 |
| 2 | 731617105017 | M.KARTHIKEYAN | EEE | 11 | 14 | 25 |
| 3 | 731617104004 | Arun | CSE | 12 | 13 | 25 |
| 4 | 1592787 | KAMALAHASAN G | EEE | 10 | 14 | 24 |
| 5 | 731617105019 | KAVIN MUTHU KUMAR | EEE | 10 | 14 | 24 |
| 6 | 731617105044 | Shyam Prashad S | EEE | 10 | 14 | 24 |
| 7 | 731617105047 | Sujith.S | EEE | 9 | 13 | 22 |
| 8 | 731617104009 | DERIL CHARLESS K | CSE | 7 | 15 | 22 |
| 9 | 1592806 | SASIKUMAR C | EEE | 8 | 13 | 21 |
| 10 | 731617105045 | S SILAMBARASAN | EEE | 8 | 13 | 21 |
| 11 | 731617104002 | AGILAN R | CSE | 7 | 14 | 21 |
| 12 | 731617105014 | JEEVITHA G | EC | 6 | 14 | 20 |
| 13 | 731617105041 | SELVAM.B | EEE | 9 | 11 | 20 |
| 14 | 731617105037 | K.SANTHOSHKUMAR | EEE | 6 | 13 | 19 |
| 15 | 731617105022 | M.MANJUPRIYA | EEE | 6 | 12 | 18 |
| 16 | 731617105025 | NANDAKUMAARAN S | EEE | 3 | 15 | 18 |
| 17 | 731617105027 | PARAMASIVAM R | EEE | 5 | 13 | 18 |
| 18 | 731617105035 | RAMYA.P | EEE | 5 | 13 | 18 |
| 19 | 731617105038 | saransarvesh m | EEE | 4 | 14 | 18 |
| 20 | 731617105001 | arul m | EEE | 8 | 9 | 17 |
| 21 | 1592789 | KAVINKUMAR M | EE | 8 | 9 | 17 |
| 22 | 731617104020 | harish | CSE | 9 | 8 | 17 |
| 23 | 731617105004 | Bharath.S | EEE | 6 | 10 | 16 |
| 24 | 731617105028 | T.PERARIVU EZHIL ARASAN | EEE | 6 | 10 | 16 |
| 25 | 731617104007 | S.B chowmiya | CSE | 6 | 10 | 16 |
| 26 | 731617104014 | M.Gayathri | CSE | 6 | 10 | 16 |
| 27 | 731617105021 | C LOGESWARN | MTRE | 12 | 3 | 15 |
| 28 | 731617105050 | surya.p | EEE | 5 | 10 | 15 |
| 29 | 731617105012 | JAYASURYA K | EEE | 6 | 8 | 14 |
| 30 | 731617105020 | S.Kirubakar | 3EE-A1 | 10 | 4 | 14 |
| 31 | 731617105031 | PRAVEEN KUMAR.A | EEE | 14 | Not Attended | 14 |
| 32 | 731617104031 | N.MOHANAPREYA | CSE | 4 | 10 | 14 |
| 33 | 731617104012 | DINESHKUMAR K | CSE | 6 | 8 | 14 |
| 34 | 731617105002 | ASHA R | EEE | 4 | 9 | 13 |

 K S R INSTITUTE FOR
 ENGINEERING AND TECHNOLOGY,
 K. S. R. KALVI NAGAR,
 TIRUCHENGODE - 637 215,
 NAMANGAL D., TAMIL NADU.

| S No | College ID | Name | Branch | Time Spent and Distance | Percentage | Total |
|------|--------------|-----------------|--------|----------------------------|--------------|-------|
| 35 | 731617105009 | guganesh.r | EEE | 4 | 9 | 13 |
| 36 | 731617105013 | Jeevanandam T | EEE | 5 | 8 | 13 |
| 37 | 731617105023 | s.Manoj kumar | EEE | 13 | Not Attended | 13 |
| 38 | 731617105024 | MOHAN T | EEE | 4 | 9 | 13 |
| 39 | 731617105032 | M.PRAVEEN KUMAR | EEE | 12 | Not Attended | 12 |
| 40 | 731617104005 | Babu | CSE | 6 | 6 | 12 |
| 41 | 731617105048 | K.SUPRIYA | EEE | 3 | 9 | 12 |
| 42 | 731617104024 | kishor.p | CSE | 6 | 6 | 12 |
| 43 | 731617105008 | S. P. GOWTHAM | EEE | 10 | 1 | 11 |
| 44 | 731617105003 | BALAJI S | EEE | 4 | 5 | 9 |
| 45 | 731617105042 | shameer.s | EEE | 8 | Not Attended | 8 |
| 46 | 731617105055 | Vinoth Kumar | EEE | 1 | 7 | 8 |
| 47 | 731617104008 | DEEPAK KUMAR.J | CSE | 8 | Not Attended | 8 |
| 48 | 731617105054 | VENKATESAN.M | EEE | 4 | 3 | 7 |
| 49 | 731617104016 | GOWTHAM G | CSE | 7 | Not Attended | 7 |
| 50 | 731617104021 | kailash | CSE | 7 | Not Attended | 7 |
| 51 | 731617105049 | Suresh.p | EEE | 5 | Not Attended | 5 |
| 52 | 731617105046 | S.SUJITH | EEE | 5 | Not Attended | 5 |
| 53 | 731617106074 | SUDHA.G | ECE | 5 | Not Attended | 5 |
| 54 | 731617106064 | sivasankaran.k | ECE | 5 | Not Attended | 5 |
| 55 | 731617105033 | RAJAT KUMAR | EEE | 4 | Not Attended | 4 |
| 56 | 731617105010 | hari s.r | EEE | 2 | 1 | 3 |
| 57 | 731617105036 | sakthivel.p | EEE | 3 | Not Attended | 3 |
| 58 | 731617106022 | HARISHKUMAR.R | ECE | 3 | 0 | 3 |

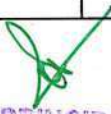
 PRINCIPAL,
 K. S. R. INSTITUTE FOR
 ENGINEERING AND TECHNOLOGY,
 K. S. R. KALYANAGAR,
 TIRUCHENGODE - 637 215,
 NAMAKKAL DISTRICT, TAMIL NADU.

TRAINING AND PLACEMENT CELL

Day 5 - Batch2 - Assessment Report by FACE Trainers

Batch:2017 -2021

Academic Year : 2019 - 2020

| S No | College ID | Name | Department | CODING AND DECODING, VISUAL | Data Arrangement and Blood | Total |
|------|--------------|--------------------------|------------|-----------------------------|----------------------------|-------|
| 1 | 731617104037 | Prakash V | CSE | 15 | 15 | 30 |
| 2 | 731617104027 | M.MANORANJITH | CSE | 15 | 15 | 30 |
| 3 | 731617104054 | VIGNESH S | CSE | 15 | 15 | 30 |
| 4 | 731617104028 | R.Marimuthu | CSE | 15 | 14 | 29 |
| 5 | 1592895 | Santhoshkumar A | CSE | 15 | 14 | 29 |
| 6 | 731617205042 | saran v | IT | 14 | 14 | 28 |
| 7 | 731617205003 | BABU | IT | 15 | 13 | 28 |
| 8 | 731617104052 | S.Veeralakshmi | CSE | 14 | 14 | 28 |
| 9 | 731617104045 | Sharmila.A | CSE | 15 | 13 | 28 |
| 10 | 731617205053 | venkateshwaran s | IT | 15 | 13 | 28 |
| 11 | 1592894 | Prasanth.T | CSE | 13 | 15 | 28 |
| 12 | 731617205026 | A.MANIKANDAN | 3IT-2 | 15 | 13 | 28 |
| 13 | 731617205030 | S.NANDHINI | IT | 15 | 12 | 27 |
| 14 | 731617205014 | JESSICA COLLINS J.PRINCE | IT | 15 | 12 | 27 |
| 15 | 731617205033 | NAVEEN KUMAR.G | IT | 13 | 14 | 27 |
| 16 | 731617104046 | Sneha.P | CSE | 14 | 13 | 27 |
| 17 | 731617104058 | Yuvashree .R | CSE | 13 | 14 | 27 |
| 18 | 731617104035 | K. Pooja shree | CSE | 14 | 13 | 27 |
| 19 | 731617104026 | Krishnamoorthy.S | CSE | 14 | 13 | 27 |
| 20 | 731617205025 | Lakshmanan R | IT | 13 | 13 | 26 |
| 21 | 731617205039 | SAANTHOSH BALAJI S.N | IT | 12 | 14 | 26 |
| 22 | 731617104055 | vijay.s | CSE | 15 | 11 | 26 |
| 23 | 731617205016 | JOTHEESWARAN R | CSE | 15 | 11 | 26 |
| 24 | 731617205027 | Mounish | IT | 13 | 12 | 25 |
| 25 | 731617104040 | purusothaman R | CSE | 15 | 10 | 25 |
| 26 | 731617205051 | THANESSHWARAN YG | IT | 15 | 9 | 24 |
| 27 | 731617205004 | S.BALAMURUGAN | 3IT-2 | 10 | 14 | 24 |
| 28 | 731617205013 | HARIPRASATH K | IT | 10 | 14 | 24 |
| 29 | 731617205002 | ARULMOZHI M | IT | 10 | 13 | 23 |

PRINCIPAL
K. S. R. INSTITUTE FOR
ENGINEERING AND TECHNOLOGY,
K. S. R. KALAM NAGAR,
TIRUCHENGODE - 637 213,
NAMAKKAL DT, TAMIL NADU.

| S No | College ID | Name | Department | CODING AND DECODING, VISUAL | Data Arrangement and Blood | Total |
|------|---------------|-----------------------------|------------|-----------------------------------|----------------------------------|-------|
| 30 | 731617205052 | Thusmeena K.R. | IT | 15 | 8 | 23 |
| 31 | 731617205055 | VINOTHINI R | IT | 14 | 9 | 23 |
| 32 | 731617205007 | Dhinakaran.K | IT | 14 | 9 | 23 |
| 33 | 731617205044 | SATHISHKUMAR V | IT | 14 | 9 | 23 |
| 34 | 731617104017 | GUNA M | CSE | 14 | 9 | 23 |
| 35 | 17ietit018 | kalidass | IT | 13 | 10 | 23 |
| 36 | 731617104050 | VAISHNAVI.V | CSE | 12 | 11 | 23 |
| 37 | 731617104051 | Valenteena Collins J Prince | CSE | 12 | 11 | 23 |
| 38 | 731617205021 | KARTHIK.T | IT | 13 | 9 | 22 |
| 39 | 2731617104025 | koteeshwaran P.N | CSE | 13 | 9 | 22 |
| 40 | 731617205035 | pavithra s | IT | 13 | 8 | 21 |
| 41 | 731617205046 | shailaa.p.m | IT | 12 | 9 | 21 |
| 42 | 731617205048 | SIVASANKARI.R | IT | 13 | 8 | 21 |
| 43 | 731617205049 | SREEMATHI INDRA | IT | 12 | 9 | 21 |
| 44 | 731617104013 | Elango.M | CSE | 11 | 10 | 21 |
| 45 | 731617205040 | SANDHIYA G | IT | 11 | 9 | 20 |
| 46 | 731617104042 | M.Sangeetha | CSE | 7 | 13 | 20 |
| 47 | 731617104034 | Pooja M | CSE | 10 | 10 | 20 |
| 48 | 731617104029 | Menaga.T | CSE | 15 | 4 | 19 |
| 49 | 731617205011 | GOBIKA M | IT | 12 | 6 | 18 |
| 50 | 731617205045 | selvamalar p | IT | 7 | 9 | 16 |
| 51 | 7316172 | ajay sriram .k | IT | 10 | 6 | 16 |
| 52 | 731617205010 | GIRINATH S | IT | 8 | 7 | 15 |
| 53 | 731617205019 | KNNAN P | IT | 7 | 7 | 14 |
| 54 | 17ietit031 | Nathiya.V | IT | 8 | 5 | 13 |
| 55 | 731617205036 | priyadharshini.p | IT | 11 | 0 | 11 |

PRINCIPAL,
K. S. R. INSTITUTE FOR
ENGINEERING AND TECHNOLOGY,
K. S. F., KALYAN NAGAR,
TIRUCHENGODE - 637 215,
NAMAKKAL DI, TAMIL NADU.

K S R INSTITUTE FOR ENGINEERING AND TECHNOLOGY , TIRUCHENGODE - 637215

TRAINING AND PLACEMENT CELL

Day 5 - Batch 3 - Assessment Report by FACE Trainers

Batch:2017 -2021

Academic Year : 2019 - 2020

| S No | Name | Branch | Numbers | Profit and Loss, Averages | Total |
|------|-----------------------------|--------|---------|---------------------------|-------|
| 1 | KAMALESHWARAN RAVICHANDIRAN | ECE | 14 | 15 | 29 |
| 2 | dharnish k | ECE | 13 | 14 | 27 |
| 3 | Gowtham.M | ECE | 13 | 13 | 26 |
| 4 | R.S.Daranidaran | ECE | 13 | 11 | 24 |
| 5 | JANARTH S | ECE | 10 | 14 | 24 |
| 6 | SRINIVASAN.S.R | ECE | 12 | 11 | 23 |
| 7 | S.HEMALATHA | ECE | 14 | 8 | 22 |
| 8 | KEERTHIVASAN.N | ECE | 11 | 11 | 22 |
| 9 | GOKULNATH.N | ECE | 7 | 14 | 21 |
| 10 | Alka p | ECE | 12 | 8 | 20 |
| 11 | Manjula.T | ECE | 12 | 8 | 20 |
| 12 | Anbazhagan.k | ECE | 11 | 8 | 19 |
| 13 | DINNESH.P | ECE | 11 | 8 | 19 |
| 14 | SANTHIYA.Y | ECE | 10 | 9 | 19 |
| 15 | SINDUJA.K | ECE | 10 | 9 | 19 |
| 16 | M.SRIDHARAN | ECE | 14 | 5 | 19 |
| 17 | YASODHA P | ECE | 8 | 11 | 19 |
| 18 | u.G.DINESH | ECE | 12 | 6 | 18 |
| 19 | Hemaharini.S | ECE | 9 | 9 | 18 |
| 20 | sharumathi.s | ECE | 11 | 7 | 18 |
| 21 | SURYAPRIYA.K | ECE | 11 | 7 | 18 |
| 22 | G.GEETHARANI | ECE | 12 | 5 | 17 |
| 23 | KISHOR.M | ECE | 15 | 2 | 17 |
| 24 | PARKAVI.P | ECE | 11 | 6 | 17 |
| 25 | PARKAVI S | ECE | 10 | 7 | 17 |
| 26 | T.ABINAYA | ECE | 8 | 8 | 16 |
| 27 | M.HARIKRISHNAN | ECE | 10 | 6 | 16 |
| 28 | SUSHMITHA.A | ECE | 9 | 7 | 16 |
| 29 | S.TEJASWINI | ECE | 7 | 9 | 16 |
| 30 | YUVANSANKAR K | ECE | 10 | 6 | 16 |
| 31 | N.Kamalini | ECE | 9 | 6 | 15 |
| 32 | s.keerthana | ECE | 10 | 5 | 15 |
| 33 | ARAVINTH R | ECE | 8 | 7 | 15 |

 PRINCIPAL,
 K. S. R. INSTITUTE FOR
 ENGINEERING AND TECHNOLOGY,
 K. S. R. JUNCTION,
 TIRUCHENGODE - 637 215,
 NAMAKKAL, Dt, TAMIL NADU.

| S No | Name | Branch | Numbers | Profit and Loss, Averages | Total |
|------|----------------------|--------|---------|---------------------------|-------|
| 34 | pavithra.T | ECE | 9 | 6 | 15 |
| 35 | Mushidha sifana.T | ECE | 10 | 4 | 14 |
| 36 | muthulakshmi.s | ECE | 10 | 4 | 14 |
| 37 | NAVEEN.L | ECE | 6 | 8 | 14 |
| 38 | k santhosh | ECE | 3 | 11 | 14 |
| 39 | A.sweetlin joshva | ECE | 8 | 6 | 14 |
| 40 | DHANUSHKODI.N | ECE | 9 | 4 | 13 |
| 41 | HARI HARA SUDHAN. R | ECE | 9 | 4 | 13 |
| 42 | RAGHURAMACHANDIRAN.V | ECE | 8 | 5 | 13 |
| 43 | RAMYA S | ECE | 6 | 7 | 13 |
| 44 | j.ruban prasad | ECE | 5 | 8 | 13 |
| 45 | A.SRINIVASAN | ECE | 11 | 2 | 13 |
| 46 | SUKHESAN C | ECE | 5 | 8 | 13 |
| 47 | KISHORE D | ECE | 7 | 5 | 12 |
| 48 | MERIN KUMAR L | ECE | 6 | 6 | 12 |
| 49 | premela | ECE | 6 | 6 | 12 |
| 50 | PRIYANKA . V | ECE | 7 | 5 | 12 |
| 51 | M M SHANMATHI | ECE | 5 | 7 | 12 |
| 52 | TAMILZHAGAN G | ECE | 7 | 5 | 12 |
| 53 | C.KARTHIKA | ECE | 7 | 4 | 11 |
| 54 | lakshmanan s | ECE | 8 | 3 | 11 |
| 55 | MADHANGOPAL C | ECE | 5 | 6 | 11 |
| 56 | G P SWETHA | ECE | 8 | 3 | 11 |
| 57 | M.Thiyagu | ECE | 6 | 5 | 11 |
| 58 | GOKULNATH.R | ECE | 4 | 6 | 10 |
| 59 | SRI RANJANI S | ECE | 5 | 5 | 10 |
| 60 | subash k | ECE | 7 | 3 | 10 |
| 61 | Dhanish | ECE | 3 | 6 | 9 |
| 62 | BALAKUMARAN.N. | ECE | 4 | 4 | 8 |
| 63 | Booma | ECE | 3 | 5 | 8 |
| 64 | NAVEEN. S. S | ECE | 3 | 5 | 8 |
| 65 | Manimala .R | ECE | 5 | 2 | 7 |
| 66 | sandhiya.k | ECE | 4 | 3 | 7 |
| 67 | SANTHIYA.T | ECE | 1 | 4 | 5 |
| 68 | Jawahar Raja.P | ECE | 1 | 3 | 4 |

K. S. R. INSTITUTE FOR
 ENGINEERING AND TECHNOLOGY,
 K. S. R. KALVI NAGAR,
 TIRUCHENGODE-637 215,
 -NAMAKKAL DI, TAMIL NADU.

**K S R INSTITUTE FOR ENGINEERING AND TECHNOLOGY
TIRUCHENGODE - 637 215**

TRAINING PROGRAMME FEEDBACK FORM



Name of the Student: N. MOHANAPREYA

Branch: BE - CCE

Year / Sem:

1. Name of the Training : Vocabulary

2. Name of the Trainer : Subarna

3. Students rating of Trainers :

| S. No. | Date | Subject | Rating (√) | | | |
|--------|---------|------------|------------|-----------|------|---------|
| | | | Excellent | Very good | Good | Average |
| 1 | 08-7-19 | Vocabulary | ✓ | | | |

4. Two positive points about the programme:

Class was very interactive

5. Suggestions for improvement:

Little bit activities

Date: 5-7-19

N. Mohan
Signature

**K S R INSTITUTE FOR ENGINEERING AND TECHNOLOGY
TIRUCHENGODE - 637 215**

TRAINING PROGRAMME FEEDBACK FORM



Name of the Student: S. R. HARI

Branch: BE / EEE

Year / Sem: III / I

1. Name of the Training : DI / DS

2. Name of the Trainer : Indhumathi

3. Students rating of Trainers :

| S. No. | Date | Subject | Rating (√) | | | |
|--------|--------|---------|------------|-----------|------|---------|
| | | | Excellent | Very good | Good | Average |
| 1 | 5-7-19 | DI/DS | | ✓ | | |

4. Two positive points about the programme:

✓ learnt how to analyse

5. Suggestions for improvement:

Give more examples

Date: 5-7-19

[Signature]
Signature

K S R INSTITUTE FOR
ENGINEERING AND TECHNOLOGY,
K. S. R. KAVY NAGAR,
TIRUCHENGODE - 637 215,
NAMAKKAL DISTRICT, TAMIL NADU.

K S R INSTITUTE FOR ENGINEERING AND TECHNOLOGY
TIRUCHENGODE - 637 215

TRAINING PROGRAMME FEEDBACK FORM



Name of the Student: M. Gayathri

Branch: CSE-III yr.

Year / Sem: III / V

1. Name of the Training: Vocabulary

2. Name of the Trainer: Suparna

3. Students rating of Trainers :

| S. No. | Date | Subject | Rating (✓) | | | |
|--------|----------|------------------|------------|-----------|------|---------|
| | | | Excellent | Very good | Good | Average |
| 1 | 05.07.19 | Vocabu- -lary | | ✓ | | |

4. Two positive points about the programme: New Words are learned. The class was so useful for us.

5. Suggestions for improvement: Nothing.

Date: 05.07.19

M. Gayathri
Signature

K S R INSTITUTE FOR ENGINEERING AND TECHNOLOGY
TIRUCHENGODE - 637 215

TRAINING PROGRAMME FEEDBACK FORM



Name of the Student: B. ASHA

Branch: BE / EEE

Year / Sem: III / V

1. Name of the Training: DI / DS

2. Name of the Trainer: Indhumathi

3. Students rating of Trainers :

| S. No. | Date | Subject | Rating (✓) | | | |
|--------|--------|---------|------------|-----------|------|---------|
| | | | Excellent | Very good | Good | Average |
| 1 | 5.7.19 | DI / DS | | ✓ | | |

4. Two positive points about the programme: Learned how to analyse and organise data sufficiency.

5. Suggestions for improvement:

Date: 5.7.19

PRINCIPAL,
K. S. R. INSTITUTE FOR
ENGINEERING AND TECHNOLOGY,
K. S. R. KANAKAVAR, TIRUCHENGODE - 637 215,
NAMANGAL DI, TAMIL NADU.

Indhumathi
Signature

**K S R INSTITUTE FOR ENGINEERING AND TECHNOLOGY
TIRUCHENGODE - 637 215**

TRAINING PROGRAMME FEEDBACK FORM



Name of the Student: M.M. SHANMATHI

Branch: ECE

Year / Sem: II / V

1. Name of the Training : VOCABULARY

2. Name of the Trainer : SUBARNA

3. Students rating of Trainers : 5

| S. No. | Date | Subject | Rating (✓) | | | |
|--------|----------|------------|------------|-----------|------|---------|
| | | | Excellent | Very good | Good | Average |
| 1 | 5-7-2019 | VOCABULARY | ✓ | | | |

4. Two positive points about the programme:

We learned meaning of new words and their origin.

5. Suggestions for improvement:

Date: 5-7-2019

M.M.S.
Signature

**K S R INSTITUTE FOR ENGINEERING AND TECHNOLOGY
TIRUCHENGODE - 637 215**

TRAINING PROGRAMME FEEDBACK FORM



Name of the Student: K. SANDHYA

Branch: ECE

Year / Sem: II / V

1. Name of the Training : TIME AND WORK

2. Name of the Trainer : SURESH

3. Students rating of Trainers :

| S. No. | Date | Subject | Rating (✓) | | | |
|--------|----------|-------------|------------|-----------|------|---------|
| | | | Excellent | Very good | Good | Average |
| 1 | 5-7-2019 | TIME & WORK | ✓ | | | |

4. Two positive points about the programme:

We learned easy methods to solve problems.

5. Suggestions for improvement:

Date: 5-7-2019

**PRINCIPAL,
K. S. R. INSTITUTE FOR
ENGINEERING AND TECHNOLOGY,
K. S. R. ROAD, VUSAR,
TIRUCHENGODE - 637 215,
NAMAKKAL DISTRICT, TAMIL NADU.**

S. Suresh
Signature

TRAINING AND PLACEMENT CELL
Day 6 - Batch 1 - Assessment Report by FACE Trainers

Batch:2017 -2021

Academic Year : 2019 - 2020

| S No | College ID | Name | Department | DI AND DS | Vocabulary | Total |
|------|--------------|-------------------------|------------|-----------|------------|-------|
| 34 | 731617104005 | Babu | CSE | 15 | 15 | 30 |
| 32 | 731617105044 | Shyam Prashad S | EEE | 15 | 13 | 28 |
| 46 | 731617104009 | DERIL CHARLESS K | CSE | 14 | 14 | 28 |
| 44 | 731617104007 | S.B chowmiya | CSE | 13 | 14 | 27 |
| 17 | 731617105023 | s.Manoj kumar | EEE | 14 | 12 | 26 |
| 42 | 731617104004 | Arun | CSE | 15 | 11 | 26 |
| 2 | 731617105002 | ASHA R | EEE | 14 | 11 | 25 |
| 18 | 731617105024 | MOHAN T | EEE | 15 | 10 | 25 |
| 20 | 731617105027 | PARAMASIVAM R | EEE | 13 | 12 | 25 |
| 49 | 731617104014 | M.Gayathri | CSE | 13 | 12 | 25 |
| 53 | 731617104024 | kishor.p | CSE | 12 | 13 | 25 |
| 4 | 731617105005 | Dinesh C | EEE | 15 | 9 | 24 |
| 9 | 731617105013 | Jeevanandam T | EEE | 14 | 10 | 24 |
| 12 | 731617105017 | M.KARTHIKEYAN | EEE | 14 | 10 | 24 |
| 8 | 731617105012 | JAYASURYA K | EEE | 13 | 10 | 23 |
| 11 | 1592787 | KAMALAHASAN G | EEE | 15 | 8 | 23 |
| 15 | 731617105020 | S.Kirubakar | 3EE-A1 | 13 | 10 | 23 |
| 19 | 731617105025 | NANDAKUMAARAN S | EEE | 11 | 12 | 23 |
| 21 | 731617105028 | T.PERARIVU EZHIL ARASAN | EEE | 12 | 11 | 23 |
| 23 | 731617105032 | M.PRAVEEN KUMAR | EEE | 15 | 8 | 23 |
| 28 | 731617105038 | saransarvesh m | EEE | 13 | 10 | 23 |
| 47 | 731617104031 | N.MOHANAPREYA | CSE | 15 | 8 | 23 |
| 27 | 731617105037 | K.SANTHOSHKUMAR | EEE | 14 | 8 | 22 |
| 31 | 731617105042 | shameer.s | EEE | 13 | 9 | 22 |
| 39 | 731617105054 | VENKATESAN.M | EEE | 14 | 8 | 22 |
| 5 | 731617105008 | S. P. GOWTHAM | EEE | 11 | 10 | 21 |
| 16 | 731617105022 | M.MANJUPRIYA | EEE | 12 | 9 | 21 |
| 29 | 1592806 | SASIKUMAR C | EEE | 11 | 10 | 21 |
| 30 | 731617105041 | SELVAM.B | EEE | 11 | 10 | 21 |
| 35 | 731617105047 | Sujith.S | EEE | 13 | 8 | 21 |

 P. S. R. INSTITUTE FOR ENGINEERING AND TECHNOLOGY,
 P. S. R. KALVIYAR, KARAIKAL,
 TAMIL NADU - 626 210,
 NARAIKAL Dt, TAMIL NADU.

| S No | College ID | Name | Department | DI AND DS | Vocabulary | Total |
|------|--------------|-------------------|------------|-----------|------------|-------|
| 50 | 731617104016 | GOWTHAM G | CSE | 11 | 10 | 21 |
| 22 | 731617105031 | PRAVEEN KUMAR.A | EEE | 13 | 7 | 20 |
| 37 | 731617105049 | Suresh.p | EEE | 12 | 8 | 20 |
| 38 | 731617105050 | surya.p | EEE | 11 | 9 | 20 |
| 14 | 731617105019 | KAVIN MUTHU KUMAR | EEE | 9 | 10 | 19 |
| 36 | 731617105048 | K.SUPRIYA | EEE | 7 | 12 | 19 |
| 48 | 731617104012 | DINESHKUMAR K | CSE | 8 | 11 | 19 |
| 10 | 731617105014 | JEEVITHA G | E&C | 8 | 10 | 18 |
| 13 | 1592789 | KAVINKUMAR M | EE | 11 | 7 | 18 |
| 41 | 731617104002 | AGILAN R | CSE | 5 | 13 | 18 |
| 3 | 731617105003 | BALAJI S | EEE | 6 | 10 | 16 |
| 6 | 731617105009 | guganesh.r | EEE | 10 | 5 | 15 |
| 25 | 731617105035 | RAMYA.P | EEE | 10 | 5 | 15 |
| 26 | 731617105036 | sakthivel.p | EEE | 8 | 7 | 15 |
| 40 | 731617105055 | Vinoth Kumar | EEE | 3 | 12 | 15 |
| 45 | 731617104008 | DEEPAK KUMAR.J | CSE | 9 | 6 | 15 |
| 33 | 731617105045 | S SILAMBARASAN | EEE | 6 | 8 | 14 |
| 1 | 731617105001 | arul m | EEE | 4 | 9 | 13 |
| 7 | 731617105010 | hari s.r | EEE | 9 | 3 | 12 |
| 51 | 731617104020 | harish | CSE | 5 | 7 | 12 |
| 24 | 731617105033 | RAJAT KUMAR | EEE | 5 | 6 | 11 |
| 52 | 731617104021 | kailash | CSE | 7 | 4 | 11 |
| 43 | 731617105046 | S.SUJITH | EEE | 4 | 6 | 10 |

 PRINCIPAL,
 K. S. R. INSTITUTE FOR
 ENGINEERING AND TECHNOLOGY,
 K. S. R. KALVI NAGAR,
 TIRUCHENGODE-637 215,
 NAMAKKAL Dt. TAMIL NADU.

TRAINING AND PLACEMENT CELL

Day 6 - Batch2 - Assessment Report by FACE Trainers

Batch:2017 -2021

Academic Year : 2019 - 2020

| S No | College ID | Name | Department | DI AND DS | Vocabulary | Total |
|------|--------------|--------------------------|------------|-----------|------------|-------|
| 50 | 731617205004 | S.BALAMURUGAN | 3IT-2 | 15 | 15 | 30 |
| 31 | 731617104035 | K. Pooja shree | CSE | 15 | 10 | 25 |
| 36 | 731617205025 | Lakshmanan R | IT | 14 | 11 | 25 |
| 39 | 731617104037 | Prakash V | CSE | 14 | 11 | 25 |
| 30 | 731617104045 | Sharmila.A | CSE | 14 | 10 | 24 |
| 41 | 731617104027 | M.MANORANJITH | CSE | 14 | 10 | 24 |
| 42 | 731617104054 | VIGNESH S | CSE | 14 | 10 | 24 |
| 40 | 731617104028 | R.Marimuthu | CSE | 13 | 10 | 23 |
| 17 | 731617205042 | saran v | IT | 12 | 10 | 22 |
| 21 | 731617205027 | Mounish | IT | 12 | 10 | 22 |
| 37 | 731617205053 | venkateshwaran s | IT | 11 | 11 | 22 |
| 53 | 7316172 | ajay sriram .k | IT | 11 | 11 | 22 |
| 13 | 731617205014 | JESSICA COLLINS J.PRINCE | IT | 8 | 13 | 21 |
| 32 | 731617104042 | M.Sangeetha | CSE | 13 | 8 | 21 |
| 20 | 731617205003 | BABU | IT | 9 | 11 | 20 |
| 28 | 731617104046 | Sneha.P | CSE | 12 | 8 | 20 |
| 29 | 731617104058 | Yuvashree .R | CSE | 11 | 9 | 20 |
| 38 | 731617205039 | SAANTHOSH BALAJI S.N | IT | 12 | 8 | 20 |
| 2 | 731617205035 | pavithra s | IT | 10 | 9 | 19 |
| 4 | 731617205030 | S.NANDHINI | IT | 11 | 8 | 19 |
| 5 | 731617205047 | N shivani | IT | 7 | 12 | 19 |
| 7 | 731617205011 | GOBIKA M | IT | 10 | 9 | 19 |
| 9 | 731617205048 | SIVASANKARI.R | IT | 10 | 8 | 18 |
| 48 | 731617205026 | A.MANIKANDAN | 3IT-2 | 11 | 7 | 18 |
| 15 | 731617205007 | Dhinakaran.K | IT | 4 | 13 | 17 |
| 18 | 731617205033 | NAVEEN KUMAR.G | IT | 9 | 8 | 17 |
| 11 | 731617205055 | VINOTHINI R | IT | 9 | 7 | 16 |
| 12 | 731617205040 | SANDHIYA G | IT | 8 | 8 | 16 |
| 23 | 17ietit018 | kalidass | IT | 10 | 6 | 16 |
| 47 | 1592895 | Santhoshkumar A | CSE | 6 | 10 | 16 |

 PRINCIPAL
 K. S. R. INSTITUTE FOR
 ENGINEERING AND TECHNOLOGY,
 K. S. R. VEDAIYAR,
 THIRUCHENGODE - 627 215,
 NARAKUDAI DR, TAMIL NADU.

| | | | | | | |
|----|---------------|-----------------------------|-----|----|----|----|
| 8 | 731617205052 | Muslimeena R.R. | IT | 10 | 4 | 14 |
| 10 | 731617205049 | SREEMATHI INDRA | IT | 10 | 4 | 14 |
| 26 | 731617104052 | S.Veeralakshmi | CSE | 9 | 5 | 14 |
| 43 | 731617104040 | purusothaman R | CSE | 7 | 7 | 14 |
| 46 | 1592894 | Prasanth.T | CSE | 8 | 6 | 14 |
| 49 | 731617205051 | THANESHWARAN YG | IT | 9 | 5 | 14 |
| 27 | 731617104029 | Menaga.T | CSE | 7 | 6 | 13 |
| 54 | 731617205019 | KNNAN P | IT | 2 | 11 | 13 |
| 1 | 17ietit031 | Nathiya.V | IT | 5 | 7 | 12 |
| 3 | 731617205046 | shailaa.p.m | IT | 9 | 3 | 12 |
| 14 | 731617205021 | KARTHIK.T | IT | 8 | 4 | 12 |
| 44 | 731617104026 | Krishnamoorthy.S | CSE | 4 | 8 | 12 |
| 16 | 731617205010 | GIRINATH S | IT | 4 | 7 | 11 |
| 19 | 2731617104025 | koteeshwaran P.N | CSE | 3 | 8 | 11 |
| 45 | 731617104055 | vijay.s | CSE | 8 | 3 | 11 |
| 6 | 731617205002 | ARULMOZHI M | IT | 6 | 4 | 10 |
| 51 | 731617205013 | HARIPRASATH K | IT | 5 | 5 | 10 |
| 52 | 731617205016 | JOTHEESWARAN R | CSE | 3 | 6 | 9 |
| 22 | 731617104017 | GUNA M | CSE | 5 | 2 | 7 |
| 24 | 731617104013 | Elango.M | CSE | 1 | 6 | 7 |
| 33 | 731617104050 | VAISHNAVI.V | CSE | 2 | 3 | 5 |
| 34 | 731617104051 | Valenteena Collins J Prince | CSE | 2 | 3 | 5 |
| 35 | 731617104034 | Pooja M | CSE | 2 | 3 | 5 |
| 25 | 731617205036 | priyadarshini p | IT | 2 | 2 | 4 |

| | | | | | | |
|----|---------------|-------------------|-----|----|----|----|
| 33 | 1592948 | MERIN KUMAR L | ECE | 9 | 8 | 17 |
| 62 | 731617106079 | A.sweetlin joshva | ECE | 9 | 8 | 17 |
| 27 | 731617106033 | KISHOR.M | ECE | 5 | 11 | 16 |
| 60 | 1592976/73161 | SURYAPRIYA.K | ECE | 7 | 9 | 16 |
| 64 | 731617106081 | TAMILZHAGAN G | ECE | 11 | 5 | 16 |
| 69 | 731617106022 | HARISHKUMAR.R | ECE | 14 | 2 | 16 |
| 18 | 731617106023 | Hemaharini.S | ECE | 5 | 10 | 15 |
| 23 | 731617106029 | N.Kamalini | ECE | 3 | 12 | 15 |
| 39 | 731617106045 | PARKAVI.P | ECE | 6 | 9 | 15 |
| 40 | 731617106046 | PARKAVI S | ECE | 7 | 8 | 15 |
| 46 | 731617106055 | j.ruban prasad | ECE | 7 | 8 | 15 |
| 55 | 731617106069 | A.SRINIVASAN | ECE | 7 | 8 | 15 |
| 61 | 731617106078 | SUSHMITHA.A | ECE | 7 | 8 | 15 |
| 25 | 731617106031 | s.keerthana | ECE | 8 | 6 | 14 |
| 42 | 1592957 | premela | ECE | 7 | 7 | 14 |
| 51 | 731617106061 | M M SHANMATHI | ECE | 11 | 3 | 14 |
| 4 | 1592919 | BALAKUMARAN.N. | ECE | 9 | 4 | 13 |
| 10 | 6381718918 | u.G.DINESH | ECE | 8 | 5 | 13 |
| 29 | 731617106035 | lakshmanan s | ECE | 8 | 5 | 13 |
| 35 | 1592950 | muthulakshmi.s | ECE | 6 | 7 | 13 |
| 49 | 731617106058 | SANTHIYA.Y | ECE | 8 | 5 | 13 |
| 70 | 731617106064 | sivasankaran.k | ECE | 6 | 7 | 13 |
| 24 | 731617106030 | C.KARTHIKA | ECE | 6 | 6 | 12 |
| 47 | 731617106056 | sandhiya.k | ECE | 6 | 6 | 12 |
| 58 | 731617106073 | subash k | ECE | 6 | 6 | 12 |
| 59 | 15929775 | SUKHESAN C | ECE | 4 | 8 | 12 |
| 66 | 731617106084 | M.Thiyagu | ECE | 5 | 7 | 12 |
| 31 | 731617106037 | Manimala .R | ECE | 7 | 4 | 11 |
| 38 | 731617106043 | NAVEEN. S S | ECE | 4 | 7 | 11 |
| 63 | 731617106080 | G P SWETHA | ECE | 6 | 5 | 11 |
| 37 | 731617106042 | NAVEEN.L | ECE | 6 | 4 | 10 |
| 41 | 1592956 | pavithra.T | ECE | 4 | 6 | 10 |
| 48 | 731617106057 | SANTHIYA.T | ECE | 6 | 4 | 10 |
| 53 | 1592969 | SREEMATHI.G | ECE | 4 | 5 | 9 |
| 5 | 731617106007 | Booma | ECE | 5 | 3 | 8 |
| 7 | 1592922 | Dhanish | ECE | 3 | 3 | 6 |

K. S. R. INSTITUTE OF TECHNOLOGY,
 ENGINEERING AND TECHNOLOGY,
 K. S. R. KALVI NAGAR,
 TIRUCHENGODE - 637 215,
 NAMAKKAL DISTRICT, TAMIL NADU.

K S R INSTITUTE FOR ENGINEERING AND TECHNOLOGY , TIRUCHENGODE - 637215

TRAINING AND PLACEMENT CELL

Day 6 - Batch 3 - Assessment Report by FACE Trainers

Batch:2017 -2021

Academic Year : 2019 - 2020

| S No | College ID | Name | Branch | Vocabulary | Time and Work | Total |
|------|---------------|----------------------|--------|------------|---------------|-------|
| 9 | 731617106012/ | dharnish k | ECE | 15 | 15 | 30 |
| 6 | 1592921 | R.S.Daranidaran | ECE | 15 | 14 | 29 |
| 15 | 731617106019 | Gowtham.M | ECE | 14 | 15 | 29 |
| 26 | 731617106032 | KEERTHIVASAN.N | ECE | 15 | 14 | 29 |
| 28 | 731617106034 | KISHORE D | ECE | 14 | 13 | 27 |
| 3 | 1592918 | Anbazhagan.k | ECE | 13 | 13 | 26 |
| 54 | 731617106068 | M.SRIDHARAN | ECE | 11 | 15 | 26 |
| 36 | 1592951 | ARAVINTH R | ECE | 14 | 11 | 25 |
| 44 | 731617106051 | RAGHURAMACHANDIRAN.V | ECE | 9 | 15 | 24 |
| 22 | 731617106028 | KAMALESHWARAN | ECE | 13 | 10 | 23 |
| 30 | 731617106036 | MADHANGOPAL C | ECE | 13 | 10 | 23 |
| 20 | 731617106025 | JANARTH S | ECE | 13 | 9 | 22 |
| 57 | 731617106071 | SRI RANJANI S | ECE | 14 | 8 | 22 |
| 32 | 731617106038 | Manjula.T | ECE | 10 | 11 | 21 |
| 52 | 731617106063 | SINDUJA.K | ECE | 13 | 8 | 21 |
| 65 | 731617106082 | S.TEJASWINI | ECE | 13 | 8 | 21 |
| 2 | 731617106003 | Alka p | ECE | 8 | 12 | 20 |
| 13 | 731617106017 | GOKULNATH.N | ECE | 13 | 7 | 20 |
| 14 | 731617106018 | GOKULNATH.R | ECE | 15 | 5 | 20 |
| 21 | 731617106027 | Jawahar Raja.P | ECE | 10 | 10 | 20 |
| 34 | 731617106040 | Mushidha sifana.T | ECE | 9 | 11 | 20 |
| 56 | 731617106070 | SRINIVASAN.S.R | ECE | 9 | 11 | 20 |
| 67 | 731617106086 | YASODHA P | ECE | 12 | 8 | 20 |
| 17 | 731617106021 | M.HARIKRISHNAN | ECE | 12 | 7 | 19 |
| 19 | 731617106024 | S.HEMALATHA | ECE | 10 | 9 | 19 |
| 45 | 731617106052/ | RAMYA S | ECE | 9 | 10 | 19 |
| 50 | 731617106059 | k santhosh | ECE | 11 | 8 | 19 |
| 68 | 731617106087 | YUVANSANKAR K | ECE | 6 | 13 | 19 |
| 43 | 731617106050 | PRIYANKA . V | ECE | 12 | 6 | 18 |
| 1 | 731617106002 | T.ABINAYA | ECE | 12 | 5 | 17 |
| 8 | 731617106011 | DHANUSHKODI.N | ECE | 6 | 11 | 17 |
| 11 | 731617106015 | DINNESH.P | ECE | 11 | 6 | 17 |
| 12 | 731617106016 | G.GEETHARANI | ECE | 10 | 7 | 17 |
| 16 | 731617106020 | HARI HARA SUDHAN. R | ECE | 5 | 12 | 17 |

PRINCIPAL,
 K S R INSTITUTE FOR
 ENGINEERING AND TECHNOLOGY,
 K. S. R. HALL, ROAD,
 TIRUCHENGODE - 637 215,
 NAIKAKKAL D., TAMIL NADU.

**K S R INSTITUTE FOR ENGINEERING AND TECHNOLOGY
TIRUCHENGODE - 637 215**

TRAINING PROGRAMME FEEDBACK FORM



Name of the Student: S. Balaraman

Branch: B.Tech - IT

Year / Sem: II / IV

1. Name of the Training: Profit And Loss

2. Name of the Trainer: Nima Joshy

3. Students rating of Trainers: 6

| S. No. | Date | Subject | Rating (✓) | | | |
|--------|------------|-----------------|------------|-----------|------|---------|
| | | | Excellent | Very good | Good | Average |
| 1 | 06.07.2019 | Profit And Loss | | ✓ | | |

4. Two positive points about the programme:

In this program is a very useful and teaching is a very good.

5. Suggestions for improvement:

need to guide students more technically give more information for students.

Date: 06-07-2019

S. Balaraman
Signature

**K S R INSTITUTE FOR ENGINEERING AND TECHNOLOGY
TIRUCHENGODE - 637 215**

TRAINING PROGRAMME FEEDBACK FORM



Name of the Student: K. AJAY SRIRAM.

Branch: B.Tech - IT

Year / Sem: III / IV

1. Name of the Training: Profit & Loss

2. Name of the Trainer: Nima Joshy

3. Students rating of Trainers: 9

| S. No. | Date | Subject | Rating (✓) | | | |
|--------|---------|-----------------|------------|-----------|------|---------|
| | | | Excellent | Very good | Good | Average |
| 1 | 06.7.19 | Profit and Loss | ✓ | | | |

4. Two positive points about the programme:

It was very interesting in that topic. Super really good.

5. Suggestions for improvement:

Need to give basic idea knowledge for the students so it is very easy.

Date:

06.07.2019

K. Ajay Sriram
Signature

**K S R INSTITUTE FOR ENGINEERING AND TECHNOLOGY
TIRUCHENGODE - 637 215**

TRAINING PROGRAMME FEEDBACK FORM



Name of the Student: Gr. Mounish

Branch: IT

Year / Sem: III / V

1. Name of the Training : Percentages

2. Name of the Trainer : Prasad

3. Students rating of Trainers : 3

| S. No. | Date | Subject | Rating (✓) | | | |
|--------|----------|-------------|------------|-----------|------|---------|
| | | | Excellent | Very good | Good | Average |
| 1 | 6.7.2019 | Percentages | | | ✓ | |

4. Two positive points about the programme: Excellent way of presentation
good knowledge about topic

5. Suggestions for improvement:

please interact with students

G. Mounish
Signature

Date: 06.07.2019

**K S R INSTITUTE FOR ENGINEERING AND TECHNOLOGY
TIRUCHENGODE - 637 215**

TRAINING PROGRAMME FEEDBACK FORM



Name of the Student: BABU. U. S.

Branch: IT

Year / Sem: III / V

1. Name of the Training : Percentages

2. Name of the Trainer : Prasad.

3. Students rating of Trainers : 4

| S. No. | Date | Subject | Rating (✓) | | | |
|--------|----------|-------------|------------|-----------|------|---------|
| | | | Excellent | Very good | Good | Average |
| 1 | 6.7.2019 | Percentages | | | ✓ | |

4. Two positive points about the programme: Interaction with the students was good, the last five minutes for speaking (stage speaking)

5. Suggestions for improvement: was also good.

Break between days of training can be given.

Date: 06.07.19.

B. U. S.
Signature

**K S R INSTITUTE FOR ENGINEERING AND TECHNOLOGY
TIRUCHENGODE - 637 215**

TRAINING PROGRAMME FEEDBACK FORM



Name of the Student: ARUNKUMAR . N

Branch: CSE - III

Year / Sem: III / V

1. Name of the Training : NIMA JOSHY PROFIT & LOSS

2. Name of the Trainer : NIMA JOSHY

3. Students rating of Trainers : 5 (EXCELLENT)

| S. No. | Date | Subject | Rating (✓) | | | |
|--------|----------|---------------|------------|-----------|------|---------|
| | | | Excellent | Very good | Good | Average |
| 1 | 6-7-2019 | PROFIT & LOSS | ✓ | | | |

4. Two positive points about the programme:

Good way of approaching

5. Suggestions for improvement:

Need more difficult problem to practice

Date: 6-7-2019

N. Aley
Signature

**K S R INSTITUTE FOR ENGINEERING AND TECHNOLOGY
TIRUCHENGODE - 637 215**

TRAINING PROGRAMME FEEDBACK FORM



Name of the Student: DTNESH . C

Branch: EEE / 3rd year

Year / Sem: 3rd / V

1. Name of the Training : Profit & loss.

2. Name of the Trainer : Nima Joshy

3. Students rating of Trainers : Excellent

| S. No. | Date | Subject | Rating (✓) | | | |
|--------|--------|----------------|------------|-----------|------|---------|
| | | | Excellent | Very good | Good | Average |
| 1 | 6/7/19 | Profit & loss. | ✓ | | | |

4. Two positive points about the programme:

→ Good teaching & interacting.

5. Suggestions for improvement:

→ more examples

Date: 6/7/19

[Signature]
Signature

PRINCIPAL
K. S. R. INSTITUTE FOR ENGINEERING AND TECHNOLOGY,
K. S. R. KALYANAGAR,
TIRUCHENGODE - 637 215,
NAMAKKAL Dt, TAMIL NADU.

**K S R INSTITUTE FOR ENGINEERING AND TECHNOLOGY
TIRUCHENGODE - 637 215**

TRAINING PROGRAMME FEEDBACK FORM



Name of the Student: K. Jeeva Charles

Branch: CSE

Year / Sem: III / V

1. Name of the Training: Reo DATA Arrangements

2. Name of the Trainer: Santhosh

3. Students rating of Trainers: 5/5

| S. No. | Date | Subject | Rating (✓) | | | |
|--------|-----------|-----------------|------------|-----------|------|---------|
| | | | Excellent | Very good | Good | Average |
| 1 | 6.07.2019 | DATA management | | ✓ | | |

4. Two positive points about the programme: Easy to understand the problems with easy method

5. Suggestions for improvement: Need loud voice and more inducations

Date: 6-07-19

K. Jeeva Charles
Signature

**K S R INSTITUTE FOR ENGINEERING AND TECHNOLOGY
TIRUCHENGODE - 637 215**

TRAINING PROGRAMME FEEDBACK FORM



Name of the Student: R. Agilan

Branch: CSE

Year / Sem: III / V

1. Name of the Training: Data Arrangements

2. Name of the Trainer: Santhosh

3. Students rating of Trainers: 5/5

| S. No. | Date | Subject | Rating (✓) | | | |
|--------|------------|-------------------|------------|-----------|------|---------|
| | | | Excellent | Very good | Good | Average |
| 1 | 06.07.2019 | Data arrangements | | ✓ | | |

4. Two positive points about the programme: Given a very simplest method of solving the problems

5. Suggestions for improvement: Need loud voice

Date: 06-07-2019

R. Agilan
Signature

K. S. R. INSTITUTE FOR
ENGINEERING AND TECHNOLOGY,
K. S. R. KALAI NAGAR,
TIRUCHENGODE - 637 215,
TIRUPATTUR TALUK, TAMIL NADU.

K S R INSTITUTE FOR ENGINEERING AND TECHNOLOGY
TIRUCHENGODE - 637 215

TRAINING PROGRAMME FEEDBACK FORM



Name of the Student: M. Sridharan

Branch: ECE - B

Year / Sem: III / V

1. Name of the Training: Data requirement

2. Name of the Trainer: Santhosh

3. Students rating of Trainers: 5

| S. No. | Date | Subject | Rating (✓) | | | |
|--------|---------|------------------|------------|-----------|------|---------|
| | | | Excellent | Very good | Good | Average |
| 1 | 6/07/19 | Data requirement | ✓ | | | |

4. Two positive points about the programme: Teaching well
Give additional information

5. Suggestions for improvement: -

Date: 6/07/19

M. Santhosh
Signature

K S R INSTITUTE FOR ENGINEERING AND TECHNOLOGY
TIRUCHENGODE - 637 215

TRAINING PROGRAMME FEEDBACK FORM



Name of the Student: G. Tarniljagan

Branch: ECE

Year / Sem: III / V

1. Name of the Training: Percentages

2. Name of the Trainer: Prasad

3. Students rating of Trainers: 5

| S. No. | Date | Subject | Rating (✓) | | | |
|--------|---------|-------------|------------|-----------|------|---------|
| | | | Excellent | Very good | Good | Average |
| 1 | 6/07/19 | Percentages | | ✓ | | |

4. Two positive points about the programme: Good explanation

5. Suggestions for improvement: Try to keep moving class with little fun

Date: 6/07/19

G. Tarniljagan
Signature

PRINCIPAL,
K. S. R. INSTITUTE FOR
ENGINEERING AND TECHNOLOGY,
S. R. KALAI NAGAR,
TIRUCHENGODE - 637 215,
NAMAIKKAL Dt, TAMIL NADU.

**K S R INSTITUTE FOR ENGINEERING AND TECHNOLOGY
TIRUCHENGODE - 637 215**

TRAINING PROGRAMME FEEDBACK FORM



Name of the Student: Amerin kumar.L Branch: ECE

Year / Sem: III / IV

1. Name of the Training : Data Arrangement

2. Name of the Trainer : Santhosh

3. Students rating of Trainers : 5

| S. No. | Date | Subject | Rating (√) | | | |
|--------|----------|------------------|------------|-----------|------|---------|
| | | | Excellent | Very good | Good | Average |
| 1 | 6.7.2019 | Data Arrangement | ✓ | | | |

4. Two positive points about the programme:

- 1) Expectations full filled.
- 2) They solving more problems & covering each & everyone.

5. Suggestions for improvement:

Date:

[Signature]
Signature

**K S R INSTITUTE FOR ENGINEERING AND TECHNOLOGY
TIRUCHENGODE - 637 215**

TRAINING PROGRAMME FEEDBACK FORM



Name of the Student: N. Kamalini Branch: ECE

Year / Sem: III / V

1. Name of the Training : Percentage

2. Name of the Trainer : Prasad

3. Students rating of Trainers : 5

| S. No. | Date | Subject | Rating (√) | | | |
|--------|--------|------------|------------|-----------|------|---------|
| | | | Excellent | Very good | Good | Average |
| 1 | 6.7.19 | Percentage | ✓ | | | |

4. Two positive points about the programme:

- 1) Teaching was good
- 2) clearing doubts was good.

5. Suggestions for improvement:

Date:

PRINCIPAL,
K. S. R. INSTITUTE FOR
ENGINEERING AND TECHNOLOGY,
S. R. KALMI NAGAR,
TIRUCHENGODE - 637 215,
KANNIAKKAL DI, TANIL NADU.

[Signature]
Signature



Aptitude Training

Ref: KSRIET/T&P/CIR/2019-20

Date: 19.07.2019

This is to inform that all the HoD's, Class Advisor and Training and Placement coordinators that we have planned Placement Training for III Year students topics on "Aptitude Training" (2017- 2021 batch) on from 22.07.2019-27.07.2019 at ECE Seminar Hall by Talent 2 success Learning for the academic year 2019 - 2020 (Odd Sem). All the Registered students should attend the training without fail.

| S.NO | Date & Time | Eligible Students Count |
|------|--------------------------------|----------------------------|
| 1 | 22.07.2019 to 27.07.2019 | MECH A - 31 MECH B - 34 |

V. Kalyan
T&P OFFICER
19/7/19

[Signature]
19/7/19
T&P COORDINATOR

[Signature]
PRINCIPAL

Copy to:

1. All HoDs
2. Notice Board

[Signature]
PRINCIPAL
K. S. R. INSTITUTE FOR
ENGINEERING AND TECHNOLOGY,
K. S. R. INSTITUTE FOR,
TIRUCHENGODE - 637 215,
NAMAKKAL Dt, TAMIL NADU.

| KSR | IET | |
|------------|---------|---------|
| | BATCH 1 | BATCH 1 |
| 22/07/2019 | V | Prema |
| 23/07/2019 | R | Prema |
| 24/07/2019 | Q1 | Prema |
| 25/07/2019 | Q2 | Prema |
| 26/07/2019 | Q3 | Prema |
| 27/07/2019 | Q4 | Prema |

| CODE | TOPICS |
|------|--|
| Q1 | Numbers(LCM & HCF, Factors, Problem on Numbers, Divisibility Rule, Unit Digit, Reminders), Averages, Ratio & Proportion, Partnership, Allegation & Mixtures |
| Q2 | Percentage, Profit & loss, Interest Calculation |
| Q3 | Time Speed & Distance, Time & Work, Chain Rule |
| Q4 | Permutation, Combination & Probability, DI & DS |
| R | Number Series, Syllogism, Blood Relation, Analogy, Coding & Decoding, Direction |
| V | Synonyms, Antonyms, Spotting Errors, Sentence Correction, Sentence Improvement, One word Substitutes, Spelling Test, Idioms & Phrases, Cloze Test, Comprehension |

PRINCIPAL,
K. S. R. INSTITUTE FOR
ENGINEERING AND TECHNOLOGY,
K. S. R. INDIA NAGAR,
TIRUCHENGODES - 637 215,
NAMAKKAL DI, TAMIL NADU.

| BATCH : 2017 - 2021 | | | | Hall No: MIC | | | | Academic Year: 2019 - 2020 | | | | | | | |
|----------------------------|--------------|----------------------|--------|--------------|----|----------|----|----------------------------|----|----------|----|----------|----|----------|----|
| Date of Training Programme | | | | 22.07.19 | | 23.07.19 | | 24.07.19 | | 25.07.19 | | 26.07.19 | | 27.07.19 | |
| S. No | Reg No | Name | Branch | FN | AN | FN | AN | FN | AN | FN | AN | FN | AN | FN | AN |
| 1 | 731617114003 | ARAVIND SR | MECH A | / | / | / | / | / | / | / | / | / | / | / | / |
| 2 | 731617114004 | ARUNESH J | MECH A | / | / | / | / | / | / | / | / | / | / | / | / |
| 3 | 731617114005 | CHANDRU M | MECH A | / | / | / | / | / | / | / | / | / | / | / | / |
| 4 | 731617114006 | ARUN KUMAR S | MECH A | / | / | / | / | / | / | / | / | / | / | / | / |
| 5 | 731617114007 | ARUN PRABAKARAN J | MECH A | / | / | / | / | / | / | / | / | / | / | / | / |
| 6 | 731617114010 | BALAJI S | MECH A | / | / | / | / | / | / | / | / | / | / | / | / |
| 7 | 731617114011 | BHAGAVATHI PERUMAL G | MECH A | / | / | / | / | / | / | / | / | / | / | / | / |
| 8 | 731617114013 | BOOPATHI S | MECH A | / | / | / | / | / | / | / | / | / | / | / | / |
| 9 | 731617114014 | BOOPATHIRAJA M | MECH A | / | / | / | / | / | / | / | / | / | / | / | / |
| 10 | 731617114015 | BUVANESVARAN S | MECH A | / | / | / | / | / | / | / | / | / | / | / | / |
| 11 | 731617114017 | ARUNKUMAR S | MECH A | / | / | / | / | / | / | / | / | / | / | / | / |
| 12 | 731617114018 | CHANDRU S | MECH A | / | / | / | / | / | / | / | / | / | / | / | / |
| 13 | 731617114020 | DHARANKUMAR S | MECH A | / | / | / | / | / | / | / | / | / | / | / | / |
| 14 | 731617114027 | GOKULNATH K | MECH A | / | / | / | / | / | / | / | / | / | / | / | / |
| 15 | 731617114029 | GOKULRAJ B | MECH A | / | / | / | / | / | / | / | / | / | / | / | / |
| 16 | 731617114030 | GOVINDHARASU R | MECH A | / | / | / | / | / | / | / | / | / | / | / | / |
| 17 | 731617114033 | HARIHARAN G | MECH A | / | / | / | / | / | / | / | / | / | / | / | / |
| 18 | 731617114035 | HARIPRASATH P | MECH A | / | / | / | / | / | / | / | / | / | / | / | / |
| 19 | 731617114037 | INDIRAJITH M | MECH A | / | / | / | / | / | / | / | / | / | / | / | / |
| 20 | 731617114038 | JAGATHESHWARAN N | MECH A | / | / | / | / | / | / | / | / | / | / | / | / |
| 21 | 731617114040 | KARTHICK R | MECH A | / | / | / | / | / | / | P | P | / | / | / | / |
| 22 | 731617114041 | KARTHIK AS | MECH A | / | / | / | / | / | / | / | / | / | / | / | / |
| 23 | 731617114043 | KARTHIKEYAN T | MECH A | / | / | / | / | / | / | / | / | / | / | / | / |
| 24 | 731617114044 | KARUPPAIAH K | MECH A | / | / | / | / | / | / | / | / | / | / | / | / |
| 25 | 731617114045 | KATHIRVEL M | MECH A | / | / | / | / | / | / | / | / | / | P | / | P |
| 26 | 731617114048 | KAVINKUMAR C | MECH A | / | / | / | / | / | / | / | / | / | / | / | / |
| 27 | 731617114051 | KIRUBAKARAN K | MECH A | / | / | / | / | / | / | / | / | / | / | / | / |
| 28 | 731617114052 | LOGESH M | MECH A | P | P | P | P | / | / | / | / | / | / | / | / |
| 29 | 731617114053 | MADESH K | MECH A | / | / | / | / | / | / | / | / | / | / | / | / |
| 30 | 731617114054 | MANIKANDAN R | MECH A | / | / | / | / | / | / | / | / | / | / | / | / |
| 31 | 731617114055 | MANOJ N | MECH A | / | / | / | / | / | / | / | / | / | / | / | / |
| 32 | 731617114058 | MOHANARAJ C | MECH B | / | / | / | / | / | / | / | / | / | / | / | / |
| 33 | 731617114059 | MONISH KANNA M | MECH B | / | / | / | / | / | / | / | / | / | / | / | / |

| Date of Training Programme | | | | 22.07.19 | | 23.07.19 | | 24.07.19 | | 25.07.19 | | 26.07.19 | | 27.07.19 | |
|----------------------------|--------------|-------------------|--------|----------|----|--------------|----|----------|----|----------|----|----------|----|----------|----|
| S. No | Reg No | Name | Branch | FN | AN | FN | AN | FN | AN | FN | AN | FN | AN | FN | AN |
| 34 | 731617114062 | NARESH M | MECH B | / | / | / | / | / | / | / | / | / | / | / | / |
| 35 | 731617114063 | NAVEEN M | MECH B | / | / | / | / | / | / | / | / | / | / | / | / |
| 36 | 731617114064 | NAVEEN V | MECH B | / | / | / | / | / | / | / | / | / | / | / | / |
| 37 | 731617114066 | NITHISH M | MECH B | / | / | / | / | / | / | / | / | / | / | / | / |
| 38 | 731617114067 | PAVITHRAN G | MECH B | / | / | / | / | / | / | / | / | / | / | / | / |
| 39 | 731617114070 | PRADHAP R | MECH B | / | / | / | / | / | / | / | / | / | / | / | / |
| 40 | 731617114071 | PRAGATHEESWAR E | MECH B | / | / | / | / | / | / | / | / | / | / | P | P |
| 41 | 731617114072 | PRASATH R | MECH B | / | / | / | / | / | / | / | / | / | / | / | / |
| 42 | 731617114073 | PRATHIYUMANAN M | MECH B | / | / | / | / | / | / | / | / | / | / | / | / |
| 43 | 731617114076 | PRAVEENKUMAR S | MECH B | / | / | / | / | / | / | / | / | / | / | / | / |
| 44 | 731617114077 | PREMRAJ S | MECH B | / | / | / | / | / | / | / | / | / | / | / | / |
| 45 | 731617114079 | RAMKUMAR B | MECH B | / | / | / | / | / | / | / | / | / | / | / | / |
| 46 | 731617114081 | SABARINATHAN S | MECH B | / | / | / | / | / | / | / | / | / | / | / | / |
| 47 | 731617114082 | SAKTHIVEL P | MECH B | / | / | NOT INTEREST | | | | | | | | | |
| 48 | 731617114085 | SARATH KUMAR M | MECH B | / | / | / | / | / | / | / | / | / | / | / | / |
| 49 | 731617114086 | SARAVANAA M | MECH B | / | / | / | / | / | / | / | / | / | / | / | / |
| 50 | 731617114088 | SASIKARAN S | MECH B | / | / | / | / | / | / | / | / | / | / | / | / |
| 51 | 731617114093 | SURENDHAR P | MECH B | / | / | / | / | / | / | / | / | / | / | / | / |
| 52 | 731617114094 | SURESHKUMAR A | MECH B | / | / | / | / | / | / | / | / | / | / | / | / |
| 53 | 731617114095 | SURESHMOORTHY P | MECH B | / | / | / | / | / | / | / | / | / | / | / | / |
| 54 | 731617114100 | THIRUPATHI M | MECH B | / | / | / | / | / | / | / | / | / | / | / | / |
| 55 | 731617114102 | VIGNESH R | MECH B | / | / | / | / | / | / | / | / | / | A | A | A |
| 56 | 731617114103 | VIGNESHWARAN S | MECH B | / | / | / | / | / | / | / | / | / | / | / | / |
| 57 | 731617114104 | VIJAYAKUMAR C | MECH B | / | / | / | / | / | / | / | / | / | / | / | / |
| 58 | 731617114105 | VINITH D | MECH B | / | / | / | / | / | / | / | / | / | / | / | / |
| 59 | 731617114106 | VINOTH KUMAR T | MECH B | / | / | / | / | / | / | / | / | P | P | P | P |
| 60 | 731617114107 | YASWANTHKARTHIK S | MECH B | / | / | / | / | / | / | / | / | / | / | / | / |
| 61 | 731617114301 | ABISHEK R R | MECH B | / | / | / | / | / | / | / | / | / | / | P | P |
| 62 | 731617114304 | HARIPRASATH M | MECH B | / | / | / | / | / | / | / | / | / | / | / | / |
| 63 | 731617114305 | MANIKANDAN V | MECH B | / | / | / | / | / | / | / | / | / | P | / | / |
| 64 | | RAHUL S | MECH B | / | / | / | / | / | / | / | / | / | / | / | / |
| 65 | 731617114074 | PRAVEEN H | MECH B | / | / | P | P | / | / | / | / | / | / | / | / |
| PRESENT | | | | 64 | 64 | 62 | 62 | 64 | 64 | 63 | 63 | 63 | 60 | 60 | 59 |
| ABSENT | | | | 0 | 0 | 0 | 0 | 0 | 0 | 0 | 0 | 0 | 1 | 1 | 1 |
| PERMISSION | | | | 1 | 1 | 2 | 2 | 0 | 0 | 1 | 1 | 1 | 3 | 3 | 4 |

K. S. R. KADAVANUR
ENGINEERING AND TECHNOLOGY
K. S. R. KADAVANUR,
TIRUCHENGOORU - 607 215,
NAMAKKAL DISTRICT, TAMIL NADU.

MECH A & B - Talent 2 Success Aptitude Training Attendance (Odd Semester)

| BATCH : 2017 - 2021 | | | | Hall No: MIC 101 | | | | Academic Year: 2019 - 2020 | | | | | | | |
|----------------------------|--------------|----------------------|--------|------------------|----|----------|----|----------------------------|----|----------|----|----------|----|----------|----|
| Date of Training Programme | | | | 22.07.19 | | 23.07.19 | | 24.07.19 | | 25.07.19 | | 26.07.19 | | 27.07.19 | |
| S. No | Reg No | Name | Branch | FN | AN | FN | AN | FN | AN | FN | AN | FN | AN | FN | AN |
| 1 | 731617114003 | ARAVIND SR | MECH A | / | / | / | / | / | / | / | / | / | / | / | / |
| 2 | 731617114004 | ARUNESH J | MECH A | / | / | / | / | / | / | / | / | / | / | / | / |
| 3 | 731617114005 | CHANDRU M | MECH A | / | / | / | / | / | / | / | / | / | / | / | / |
| 4 | 731617114006 | ARUN KUMAR S T | MECH A | / | / | / | / | / | / | / | / | / | / | / | / |
| 5 | 731617114007 | ARUN PRABAKARAN J | MECH A | / | / | / | / | / | / | / | / | / | / | / | / |
| 6 | 731617114010 | BALAJI S | MECH A | / | / | / | / | / | / | / | / | / | / | / | / |
| 7 | 731617114011 | BHAGAVATHI PERUMAL G | MECH A | / | / | / | / | / | / | / | / | / | / | / | / |
| 8 | 731617114013 | BOOPATHI S | MECH A | / | / | / | / | / | / | / | / | / | / | / | / |
| 9 | 731617114014 | BOOPATHIRAJA M | MECH A | / | / | / | / | / | / | / | / | / | / | / | / |
| | 731617114015 | BUVANESVARAN S | MECH A | / | / | / | / | / | / | / | / | / | / | / | / |
| 11 | 731617114017 | ARUNKUMAR S | MECH A | / | / | / | / | / | / | / | / | / | / | / | / |
| 12 | 731617114018 | CHANDRU S | MECH A | / | / | / | / | / | / | / | / | / | / | / | / |
| 13 | 731617114020 | DHARANKUMAR S | MECH A | / | / | / | / | / | / | / | / | / | / | / | / |
| 14 | 731617114027 | GOKULNATH K | MECH A | / | / | / | / | / | / | / | / | / | / | / | / |
| 15 | 731617114029 | GOKULRAJ B | MECH A | / | / | / | / | / | / | / | / | / | / | / | / |
| 16 | 731617114030 | GOVINDHARASU R | MECH A | / | / | / | / | / | / | / | / | / | / | / | / |
| 17 | 731617114033 | HARIHARAN G | MECH A | / | / | / | / | / | / | / | / | / | / | / | / |
| 18 | 731617114035 | HARIPRASATH P | MECH A | / | / | / | / | / | / | / | / | / | / | / | / |
| 19 | 731617114037 | INDIRAJITH M | MECH A | / | / | / | / | / | / | / | / | / | / | / | / |
| 20 | 731617114038 | JAGATHESHWARAN N | MECH A | / | / | / | / | / | / | / | / | / | / | / | / |
| 21 | 731617114040 | KARTHICK R | MECH A | / | / | / | / | / | / | / | / | / | / | / | / |
| | 731617114041 | KARTHIK AS | MECH A | / | / | / | / | / | / | / | / | / | / | / | / |
| 23 | 731617114043 | KARTHIKEYAN T | MECH A | / | / | / | / | / | / | / | / | / | / | / | / |
| 24 | 731617114044 | KARUPPAIAH K | MECH A | / | / | / | / | / | / | / | / | / | / | / | / |
| 25 | 731617114045 | KATHIRVEL M | MECH A | / | / | / | / | / | / | / | / | / | / | / | / |
| 26 | 731617114048 | KAVINKUMAR C | MECH A | / | / | / | / | / | / | / | / | / | / | / | / |
| 27 | 731617114051 | KIRUBAKARAN K | MECH A | / | / | / | / | / | / | / | / | / | / | / | / |
| 28 | 731617114052 | LOGESH M | MECH A | / | / | / | / | / | / | / | / | / | / | / | / |
| 29 | 731617114053 | MADESH K | MECH A | / | / | / | / | / | / | / | / | / | / | / | / |
| 30 | 731617114054 | MANIKANDAN R | MECH A | / | / | / | / | / | / | / | / | / | / | / | / |
| 31 | 731617114055 | MANOJ N | MECH A | / | / | / | / | / | / | / | / | / | / | / | / |
| 32 | 731617114058 | MOHANARAJ C | MECH B | / | / | / | / | / | / | / | / | / | / | / | / |
| 33 | 731617114059 | MONISH KANNA M | MECH B | / | / | / | / | / | / | / | / | / | / | / | / |

| Date of Training Programme | | | | 22.07.19 | | 23.07.19 | | 24.07.19 | | 25.07.19 | | 26.07.19 | | 27.07.19 | | |
|----------------------------|--------------|-----------------------------|--------|----------|----|----------|----|----------|----|----------|----|----------|----|----------|----|--|
| S. No | Reg No | Name | Branch | FN | AN | FN | AN | FN | AN | FN | AN | FN | AN | FN | AN | |
| 34 | 731617114062 | NARESH M | MECH B | / | / | / | / | / | / | / | / | / | / | / | / | |
| 35 | 731617114063 | NAVEEN M | MECH B | / | / | / | / | / | / | / | / | / | / | / | / | |
| 36 | 731617114064 | NAVEEN V | MECH B | / | / | / | / | / | / | / | / | / | / | / | / | |
| 37 | 731617114066 | NITHISH M | MECH B | / | / | / | / | / | / | / | / | / | / | / | / | |
| 38 | 731617114067 | PAVITHRAN G | MECH B | / | / | / | / | / | / | / | / | / | / | / | / | |
| 39 | 731617114070 | PRADHAP R | MECH B | / | / | / | / | / | / | / | / | / | / | / | / | |
| 40 | 731617114071 | PRAGATHEESWAR E | MECH B | / | / | / | / | / | / | / | / | / | / | / | / | |
| 41 | 731617114072 | PRASATH R | MECH B | / | / | / | / | / | / | / | / | / | / | / | / | |
| 42 | 731617114073 | PRATHIYUMANAN M | MECH B | / | / | / | / | / | / | / | / | / | / | / | / | |
| 43 | 731617114076 | PRAVEENKUMAR S | MECH B | / | / | / | / | / | / | / | / | / | / | / | / | |
| 44 | 731617114077 | PREMRAJ S | MECH B | / | / | / | / | / | / | / | / | / | / | / | / | |
| 45 | 731617114079 | RAMKUMAR B | MECH B | / | / | / | / | / | / | / | / | / | / | / | / | |
| 46 | 731617114081 | SABARINATHAN S | MECH B | / | / | / | / | / | / | / | / | / | / | / | / | |
| 47 | 731617114082 | SAKTHIVEL P | MECH B | / | / | / | / | / | / | / | / | / | / | / | / | |
| 48 | 731617114085 | SARATH KUMAR M | MECH B | / | / | / | / | / | / | / | / | / | / | / | / | |
| 49 | 731617114086 | SARAVANAA M | MECH B | / | / | / | / | / | / | / | / | / | / | / | / | |
| 50 | 731617114088 | SASIKARAN S | MECH B | / | / | / | / | / | / | / | / | / | / | / | / | |
| 51 | 731617114093 | SURENDHAR P | MECH B | / | / | / | / | / | / | / | / | / | / | / | / | |
| 52 | 731617114094 | SURESHKUMAR A | MECH B | / | / | / | / | / | / | / | / | / | / | / | / | |
| 53 | 731617114095 | SURESHMOORTHY P | MECH B | / | / | / | / | / | / | / | / | / | / | / | / | |
| 54 | 731617114100 | THIRUPATHI M | MECH B | / | / | / | / | / | / | / | / | / | / | / | / | |
| 55 | 731617114102 | VIGNESH R | MECH B | / | / | / | / | / | / | / | / | / | / | / | / | |
| 56 | 731617114103 | VIGNESHWARAN S | MECH B | / | / | / | / | / | / | / | / | / | / | / | / | |
| 57 | 731617114104 | VIJAYAKUMAR C | MECH B | / | / | / | / | / | / | / | / | / | / | / | / | |
| 58 | 731617114105 | VINITH D | MECH B | / | / | / | / | / | / | / | / | / | / | / | / | |
| 59 | 731617114106 | VINOTH KUMAR T | MECH B | / | / | / | / | / | / | / | / | / | / | / | / | |
| 60 | 731617114107 | YASWANTHKARTHIK S | MECH B | / | / | / | / | / | / | / | / | / | / | / | / | |
| 61 | 731617114301 | ABISHEK R R | MECH B | / | / | / | / | / | / | / | / | / | / | / | / | |
| 62 | 731617114304 | HARIPRASATH M <i>Kannan</i> | MECH B | / | / | / | / | / | / | / | / | / | / | / | / | |
| 63 | 731617114305 | MANIKANDAN V | MECH B | / | / | / | / | / | / | / | / | / | / | / | / | |
| 64 | | RAHUL S | MECH B | / | / | / | / | / | / | / | / | / | / | / | / | |
| 65 | 74 | <i>Potaboo K...</i> | | / | / | / | / | / | / | / | / | / | / | / | / | |
| 66 | | | | | | | | | | | | | | | | |
| PRESENT | | | | | | b4 | b3 | b2 | b2 | | | | | | | |
| ABSENT | | | | | | - | - | - | - | | | | | | | |
| PERMISSION | | | | | | 01 | 01 | 02 | 02 | | | | | | | |

K. S. R. ENGINEERING COLLEGE
K. S. R. K. V. P. ROAD,
TIRUCHENGODE - 637 215,
NAMAKKAL DISTRICT, TAMIL NADU.

TRAINING AND PLACEMENT CELL

Day 1 -MECH - Assessment Report by T2S Trainers

Batch:2017 -2021

Academic Year : 2019 - 2020

| Sl.No | RegNo | Name | Mark (100) |
|-------|--------------|----------------------|------------|
| 1 | 731617114062 | NARESH M | 77 |
| 2 | 731617114058 | MOHANARAJ C | 60 |
| 3 | 731617114095 | SURESHMOORTHY P | 60 |
| 4 | 731617114104 | VIJAYAKUMAR C | 60 |
| 5 | 731617114059 | MONISH KANNA M | 57 |
| 6 | 731617114063 | NAVEEN M | 57 |
| 7 | 731617114086 | SARAVANAA M | 57 |
| 8 | 731617114066 | NITHISH M | 54 |
| 9 | 731617114105 | VINITH D | 54 |
| 10 | 731617114064 | NAVEEN V | 51 |
| 11 | 731617114067 | PAVITHRAN G | 51 |
| 12 | 731617114301 | ABISHEK R R | 51 |
| 13 | 731617114005 | CHANDRU M | 49 |
| 14 | 731617114040 | KARTHICK R | 49 |
| 15 | 731617114071 | PRAGATHEESWAR E | 49 |
| 16 | 731617114100 | THIRUPATHI M | 49 |
| 17 | 731617114035 | HARIPRASATH P | 46 |
| 18 | 731617114037 | INDIRAJITH M | 46 |
| 19 | 731617114055 | MANOJ N | 46 |
| 20 | 731617114014 | BOOPATHIRAJA M | 43 |
| 21 | 731617114043 | KARTHIKEYAN T | 43 |
| 22 | 731617114044 | KARUPPAIAH K | 43 |
| 23 | 731617114010 | BALAJI S | 40 |
| 24 | 731617114018 | CHANDRU S | 40 |
| 25 | 731617114094 | SURESHKUMAR A | 40 |
| 26 | 731617114045 | KATHIRVEL M | 37 |
| 27 | 731617114072 | PRASATH R | 37 |
| 28 | 731617114081 | SABARINATHAN S | 37 |
| 29 | 731617114085 | SARATH KUMAR M | 37 |
| 30 | 731617114006 | ARUN KUMAR S | 34 |
| 31 | 731617114007 | ARUN PRABAKARAN J | 34 |
| 32 | 731617114015 | BUVANESVARAN S | 34 |
| 33 | 731617114033 | HARIHARAN G | 34 |
| 34 | 731617114038 | JAGATHESHWARAN N | 34 |
| 35 | 731617114048 | KAVINKUMAR C | 34 |
| 36 | 731617114076 | PRAVEENKUMAR S | 34 |
| 37 | 731617114077 | PREMRAJ S | 34 |
| 38 | 731617114079 | RAMKUMAR B | 34 |
| 39 | 731617114102 | VIGNESH R | 34 |
| 40 | 731617114106 | VINOTH KUMAR T | 34 |
| 41 | 731617114107 | YASWANTHKARTHIK S | 34 |
| 42 | 731617114304 | HARIPRASATH M | 34 |
| 43 | 731617114017 | ARUNKUMAR S | 31 |
| 44 | 731617114011 | BHAGAVATHI PERUMAL G | 29 |
| 45 | 731617114041 | KARTHIK AS | 29 |
| 46 | 731617114073 | PRATHIYUMANAN M | 29 |
| 47 | 731617114003 | ARAVIND SR | 26 |
| 48 | 731617114088 | SASIKARAN S | 26 |
| 49 | 731617114020 | DHARANKUMAR S | 23 |
| 50 | 731617114029 | GOKULRAJ B | 20 |
| 51 | 731617114030 | GOVINDHARASU R | 20 |

PRINCIPAL,
K. S. R. INSTITUTE FOR
ENGINEERING AND TECHNOLOGY,
K. S. R. NAGAR,
TIRUCHENGODE - 637215,
Karnataka.

| Sl.No | Regno | Name | |
|-------|--------------|----------------|----|
| 52 | 731617114027 | GOKULNATH K | 17 |
| 53 | 731617114053 | MADESH K | 17 |
| 54 | 731617114054 | MANIKANDAN R | 17 |
| 55 | 731617114305 | MANIKANDAN V | 14 |
| 56 | 731617114013 | BOOPATHI S | 9 |
| 57 | 731617114004 | ARUNESH J | 6 |
| 58 | 731617114051 | KIRUBAKARAN K | 6 |
| 59 | 731617114052 | LOGESH M | 6 |
| 60 | 731617114070 | PRADHAP R | 3 |
| 61 | 731617114093 | SURENDHAR P | 0 |
| 62 | 731617114000 | RAGUL S | |
| 63 | 731617114082 | SAKTHIVEL P | |
| 64 | 731617114103 | VIGNESHWARAN S | |

 PRINCIPAL,
 K. S. R. INSTITUTE FOR
 ENGINEERING AND TECHNOLOGY,
 K. S. R. ROAD, KARAIKAL,
 TIRUCHENGOORE - 637 215,
 WANAICAL DI, TAMIL NADU.

TRAINING AND PLACEMENT CELL

Day 2 -MECH - Assessment Report by T2S Trainers

Batch:2017 -2021

Academic Year : 2019 - 2020

| Sl.No | RegNo | Name | Mark (100) |
|-------|--------------|----------------------|------------|
| 1 | 731617114006 | ARUN KUMAR S | 60 |
| 2 | 731617114010 | BALAJI S | 60 |
| 3 | 731617114015 | BUVANESVARAN S | 60 |
| 4 | 731617114029 | GOKULRAJ B | 60 |
| 5 | 731617114045 | KATHIRVEL M | 60 |
| 6 | 731617114005 | CHANDRU M | 57 |
| 7 | 731617114011 | BHAGAVATHI PERUMAL G | 57 |
| 8 | 731617114044 | KARUPPAIAH K | 54 |
| 9 | 731617114095 | SURESHMOORTHY P | 54 |
| 10 | 731617114007 | ARUN PRABAKARAN J | 51 |
| 11 | 731617114048 | KAVINKUMAR C | 51 |
| 12 | 731617114066 | NITHISH M | 51 |
| 13 | 731617114071 | PRAGATHEESWAR E | 51 |
| 14 | 731617114076 | PRAVEENKUMAR S | 51 |
| 15 | 731617114102 | VIGNESH R | 51 |
| 16 | 731617114043 | KARTHIKEYAN T | 49 |
| 17 | 731617114093 | SURENDHAR P | 49 |
| 18 | 731617114030 | GOVINDHARASU R | 46 |
| 19 | 731617114055 | MANOJ N | 46 |
| 20 | 731617114064 | NAVEEN V | 46 |
| 21 | 731617114067 | PAVITHRAN G | 46 |
| 22 | 731617114094 | SURESHKUMAR A | 46 |
| 23 | 731617114100 | THIRUPATHI M | 46 |
| 24 | 731617114027 | GOKULNATH K | 43 |
| 25 | 731617114035 | HARIPRASATH P | 43 |
| 26 | 731617114038 | JAGATHESHWARAN N | 43 |
| 27 | 731617114081 | SABARINATHAN S | 43 |
| 28 | 731617114014 | BOOPATHIRAJA M | 37 |
| 29 | 731617114037 | INDIRAJITH M | 37 |
| 30 | 731617114041 | KARTHIK AS | 37 |
| 31 | 731617114062 | NARESH M | 37 |
| 32 | 731617114063 | NAVEEN M | 37 |
| 33 | 731617114013 | BOOPATHI S | 34 |
| 34 | 731617114040 | KARTHICK R | 34 |
| 35 | 731617114077 | PREMRAJ S | 34 |
| 36 | 731617114018 | CHANDRU S | 31 |
| 37 | 731617114053 | MADESH K | 31 |
| 38 | 731617114085 | SARATH KUMAR M | 31 |
| 39 | 731617114104 | VIJAYAKUMAR C | 31 |
| 40 | 731617114107 | YASWANTHKARTHIK S | 31 |
| 41 | 731617114304 | HARIPRASATH M | 31 |
| 42 | 731617114020 | DHARANKUMAR S | 29 |
| 43 | 731617114033 | HARIHARAN G | 29 |
| 44 | 731617114105 | VINITH D | 29 |
| 45 | 731617114017 | ARUNKUMAR S | 26 |
| 46 | 731617114072 | PRASATH R | 26 |
| 47 | 731617114086 | SARAVANAA M | 26 |
| 48 | 731617114088 | SASIKARAN S | 26 |
| 49 | 731617114003 | ARAVIND SR | 23 |
| 50 | 731617114051 | KIRUBAKARAN K | 23 |
| 51 | 731617114054 | MANIKANDAN R | 23 |

PRINCIPAL,
K. S. R. INSTITUTE FOR
ENGINEERING AND TECHNOLOGY,
K. S. R. KALYANPURAM,
TIRUCHENGODE - 637 215,
NAMAKKAL DISTRICT, TAMIL NADU.

| | | | |
|----|--------------|-----------------|----|
| 52 | 731617114058 | MOHANARAJ C | 23 |
| 53 | 731617114079 | RAMKUMAR B | 23 |
| 54 | 731617114301 | ABISHEK R R | 23 |
| 55 | 731617114070 | PRADHAP R | 20 |
| 56 | 731617114103 | VIGNESHWARAN S | 20 |
| 57 | 731617114305 | MANIKANDAN V | 20 |
| 58 | 731617114059 | MONISH KANNA M | 17 |
| 59 | 731617114004 | ARUNESH J | 11 |
| 60 | 731617114073 | PRATHIYUMANAN M | 9 |
| 61 | 731617114106 | VINOTH KUMAR T | 9 |
| 62 | 731617114000 | RAGUL S | |
| 63 | 731617114052 | LOGESH M | |
| 64 | 731617114082 | SAKTHIVEL P | |

PRINCIPAL,
K. S. R. INSTITUTE FOR
ENGINEERING AND TECHNOLOGY,
K. S. R. KALAI NAGAR,
TIRUCHENGODE - 637 215,
NAMAKKAL DI, TAMIL NADU.

TRAINING AND PLACEMENT CELL

Day 3 -MECH - Assessment Report by T2S Trainers

Batch:2017 -2021

Academic Year : 2019 - 2020

| Sl.No | RegNo | Name | Mark (100) |
|-------|--------------|----------------------|------------|
| 1 | 731617114041 | KARTHIK AS | 72 |
| 2 | 731617114007 | ARUN PRABAKARAN J | 69 |
| 3 | 731617114010 | BALAJI S | 66 |
| 4 | 731617114044 | KARUPPAIAH K | 62 |
| 5 | 731617114045 | KATHIRVEL M | 62 |
| 6 | 731617114005 | CHANDRU M | 59 |
| 7 | 731617114011 | BHAGAVATHI PERUMAL G | 59 |
| 8 | 731617114029 | GOKULRAJ B | 59 |
| 9 | 731617114052 | LOGESH M | 59 |
| 10 | 731617114013 | BOOPATHI S | 55 |
| 11 | 731617114015 | BUVANESVARAN S | 55 |
| 12 | 731617114063 | NAVEEN M | 55 |
| 13 | 731617114014 | BOOPATHIRAJA M | 52 |
| 14 | 731617114018 | CHANDRU S | 52 |
| 15 | 731617114043 | KARTHIKEYAN T | 52 |
| 16 | 731617114003 | ARAVIND SR | 48 |
| 17 | 731617114017 | ARUNKUMAR S | 48 |
| 18 | 731617114027 | GOKULNATH K | 48 |
| 19 | 731617114093 | SURENDHAR P | 48 |
| 20 | 731617114103 | VIGNESHWARAN S | 48 |
| 21 | 731617114006 | ARUN KUMAR S | 45 |
| 22 | 731617114020 | DHARANKUMAR S | 45 |
| 23 | 731617114064 | NAVEEN V | 45 |
| 24 | 731617114077 | PREMRAJ S | 45 |
| 25 | 731617114085 | SARATH KUMAR M | 45 |
| 26 | 731617114086 | SARAVANAA M | 41 |
| 27 | 731617114301 | ABISHEK R R | 41 |
| 28 | 731617114038 | JAGATHESHWARAN N | 38 |
| 29 | 731617114062 | NARESH M | 38 |
| 30 | 731617114081 | SABARINATHAN S | 38 |
| 31 | 731617114094 | SURESHKUMAR A | 38 |
| 32 | 731617114105 | VINITH D | 38 |
| 33 | 731617114107 | YASWANTHKARTHIK S | 38 |
| 34 | 731617114030 | GOVINDHARASU R | 34 |
| 35 | 731617114033 | HARIHARAN G | 34 |
| 36 | 731617114035 | HARIPRASATH P | 34 |
| 37 | 731617114037 | INDIRAJITH M | 34 |
| 38 | 731617114051 | KIRUBAKARAN K | 34 |
| 39 | 731617114076 | PRAVEENKUMAR S | 34 |
| 40 | 731617114088 | SASIKARAN S | 34 |
| 41 | 731617114054 | MANIKANDAN R | 31 |
| 42 | 731617114059 | MONISH KANNA M | 28 |
| 43 | 731617114067 | PAVITHRAN G | 28 |
| 44 | 731617114079 | RAMKUMAR B | 28 |
| 45 | 731617114304 | HARIPRASATH M | 28 |
| 46 | 731617114055 | MANOJ N | 24 |
| 47 | 731617114070 | PRADHAP R | 24 |
| 48 | 731617114095 | SURESHMOORTHY P | 24 |
| 49 | 731617114100 | THIRUPATHI M | 24 |
| 50 | 731617114053 | MADESH K | 21 |
| 51 | 731617114071 | PRAGATHEESWAR E | 21 |

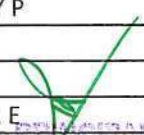
 PRINCIPAL,
 K. S. R. INSTITUTE FOR
 ENGINEERING AND TECHNOLOGY,
 1, D. S. MANIYAR, S. S. ROAD,
 TIRUCHENGODE - 637213,
 Tamil Nadu, India.

| | | | |
|----|--------------|-----------------|----|
| 52 | 731617114072 | PRASATH R | 21 |
| 53 | 731617114104 | VIJAYAKUMAR C | 21 |
| 54 | 731617114004 | ARUNESH J | 17 |
| 55 | 731617114066 | NITHISH M | 17 |
| 56 | 731617114102 | VIGNESH R | 17 |
| 57 | 731617114106 | VINOTH KUMAR T | 17 |
| 58 | 731617114058 | MOHANARAJ C | 14 |
| 59 | 731617114073 | PRATHIYUMANAN M | 14 |
| 60 | 731617114305 | MANIKANDAN V | 10 |
| 61 | 731617114048 | KAVINKUMAR C | 7 |
| 62 | 731617114000 | RAGUL S | |
| 63 | 731617114040 | KARTHICK R | |
| 64 | 731617114082 | SAKTHIVEL P | |

PRINCIPAL,
K. S. R. INSTITUTE FOR
ENGINEERING AND TECHNOLOGY,
K. S. P. NALLI NAGAR,
CHENGODE - 637 215,
MADRASKAL DE, TAMIL NADU.

TRAINING AND PLACEMENT CELL

Day 4 -MECH - Assessment Report by T2S Trainers

Batch:2017 -2021

Academic Year : 2019 - 2020

| Sl.No | RegNo | Name | Mark (100) |
|-------|--------------|----------------------|------------|
| 1 | 731617114011 | BHAGAVATHI PERUMAL G | 60 |
| 2 | 731617114020 | DHARANKUMAR S | 60 |
| 3 | 731617114010 | BALAJI S | 57 |
| 4 | 731617114006 | ARUN KUMAR S | 54 |
| 5 | 731617114014 | BOOPATHIRAJA M | 54 |
| 6 | 731617114018 | CHANDRU S | 54 |
| 7 | 731617114029 | GOKULRAJ B | 54 |
| 8 | 731617114030 | GOVINDHARASU R | 54 |
| 9 | 731617114035 | HARIPRASATH P | 54 |
| 10 | 731617114044 | KARUPPAIAH K | 54 |
| 11 | 731617114045 | KATHIRVEL M | 54 |
| 12 | 731617114003 | ARAVIND SR | 51 |
| 13 | 731617114013 | BOOPATHI S | 51 |
| 14 | 731617114048 | KAVINKUMAR C | 51 |
| 15 | 731617114052 | LOGESH M | 51 |
| 16 | 731617114104 | VIJAYAKUMAR C | 51 |
| 17 | 731617114017 | ARUNKUMAR S | 49 |
| 18 | 731617114033 | HARIHARAN G | 49 |
| 19 | 731617114043 | KARTHIKEYAN T | 49 |
| 20 | 731617114064 | NAVEEN V | 49 |
| 21 | 731617114007 | ARUN PRABAKARAN J | 46 |
| 22 | 731617114027 | GOKULNATH K | 46 |
| 23 | 731617114037 | INDIRAJITH M | 46 |
| 24 | 731617114040 | KARTHICK R | 46 |
| 25 | 731617114076 | PRAVEENKUMAR S | 46 |
| 26 | 731617114005 | CHANDRU M | 43 |
| 27 | 731617114038 | JAGATHESHWARAN N | 43 |
| 28 | 731617114041 | KARTHIK AS | 43 |
| 29 | 731617114107 | YASWANTHKARTHIK S | 43 |
| 30 | 731617114093 | SURENDHAR P | 40 |
| 31 | 731617114105 | VINITH D | 40 |
| 32 | 731617114067 | PAVITHRAN G | 37 |
| 33 | 731617114077 | PREMRAJ S | 37 |
| 34 | 731617114304 | HARIPRASATH M | 37 |
| 35 | 731617114062 | NARESH M | 34 |
| 36 | 731617114301 | ABISHEK R R | 34 |
| 37 | 731617114305 | MANIKANDAN V | 34 |
| 38 | 731617114051 | KIRUBAKARAN K | 31 |
| 39 | 731617114054 | MANIKANDAN R | 31 |
| 40 | 731617114066 | NITHISH M | 31 |
| 41 | 731617114102 | VIGNESH R | 31 |
| 42 | 731617114000 | RAGUL S | 29 |
| 43 | 731617114015 | BUVANESVARAN S | 29 |
| 44 | 731617114063 | NAVEEN M | 29 |
| 45 | 731617114071 | PRAGATHEESWAR E | 29 |
| 46 | 731617114100 | THIRUPATHI M | 29 |
| 47 | 731617114103 | VIGNESHWARAN S | 29 |
| 48 | 731617114053 | MADESH K | 26 |
| 49 | 731617114058 | MOHANARAJ C | 26 |
| 50 | 731617114079 | RAMKUMAR B | 26 |
| 51 | 731617114088 | SASIKARAN S | 26 |

K. S. S. INSTITUTE FOR
 ENGINEERING TECHNOLOGY,
 T. N. S. ROAD, K. S. S.,
 KANNIYAKUMAR, TAMIL NADU.

| | | | |
|----|--------------|-----------------|----|
| 52 | 731617114095 | SURESHMOORTHY P | 26 |
| 53 | 731617114055 | MANOJ N | 23 |
| 54 | 731617114072 | PRASATH R | 23 |
| 55 | 731617114081 | SABARINATHAN S | 23 |
| 56 | 731617114085 | SARATH KUMAR M | 23 |
| 57 | 731617114059 | MONISH KANNA M | 20 |
| 58 | 731617114094 | SURESHKUMAR A | 20 |
| 59 | 731617114004 | ARUNESH J | 17 |
| 60 | 731617114070 | PRADHAP R | 17 |
| 61 | 731617114086 | SARAVANAA M | 17 |
| 62 | 731617114073 | PRATHIYUMANAN M | 9 |
| 63 | 731617114082 | SAKTHIVEL P | |
| 64 | 731617114106 | VINOTH KUMAR T | |

PRINCIPAL,
K. S. R. INSTITUTE FOR
ENGINEERING AND TECHNOLOGY,
K. S. R. KALMI NAGAR,
TIRUCHENGODE - 637 215,
NAMAGOL DI, TAMIL NADU.

TRAINING AND PLACEMENT CELL

Day 5 -MECH - Assessment Report by T2S Trainers

Batch:2017 -2021

Academic Year : 2019 - 2020

| Sl.No | RegNo | Name | Mark (100) |
|-------|--------------|----------------------|------------|
| 1 | 731617114011 | BHAGAVATHI PERUMAL G | 60 |
| 2 | 731617114020 | DHARANKUMAR S | 60 |
| 3 | 731617114010 | BALAJI S | 57 |
| 4 | 731617114006 | ARUN KUMAR S | 54 |
| 5 | 731617114014 | BOOPATHIRAJA M | 54 |
| 6 | 731617114018 | CHANDRU S | 54 |
| 7 | 731617114029 | GOKULRAJ B | 54 |
| 8 | 731617114030 | GOVINDHARASU R | 54 |
| 9 | 731617114035 | HARIPRASATH P | 54 |
| 10 | 731617114044 | KARUPPAIAH K | 54 |
| 11 | 731617114045 | KATHIRVEL M | 54 |
| 12 | 731617114003 | ARAVIND SR | 51 |
| 13 | 731617114013 | BOOPATHI S | 51 |
| 14 | 731617114048 | KAVINKUMAR C | 51 |
| 15 | 731617114052 | LOGESH M | 51 |
| 16 | 731617114104 | VIJAYAKUMAR C | 51 |
| 17 | 731617114017 | ARUNKUMAR S | 49 |
| 18 | 731617114033 | HARIHARAN G | 49 |
| 19 | 731617114043 | KARTHIKEYAN T | 49 |
| 20 | 731617114064 | NAVEEN V | 49 |
| 21 | 731617114007 | ARUN PRABAKARAN J | 46 |
| 22 | 731617114027 | GOKULNATH K | 46 |
| 23 | 731617114037 | INDIRAJITH M | 46 |
| 24 | 731617114040 | KARTHICK R | 46 |
| 25 | 731617114076 | PRAVEENKUMAR S | 46 |
| 26 | 731617114005 | CHANDRU M | 43 |
| 27 | 731617114038 | JAGATHESHWARAN N | 43 |
| 28 | 731617114041 | KARTHIK AS | 43 |
| 29 | 731617114107 | YASWANTHKARTHIK S | 43 |
| 30 | 731617114093 | SURENDHAR P | 40 |
| 31 | 731617114105 | VINITH D | 40 |
| 32 | 731617114067 | PAVITHRAN G | 37 |
| 33 | 731617114077 | PREMRAJ S | 37 |
| 34 | 731617114304 | HARIPRASATH M | 37 |
| 35 | 731617114062 | NARESH M | 34 |
| 36 | 731617114301 | ABISHEK R R | 34 |
| 37 | 731617114305 | MANIKANDAN V | 34 |
| 38 | 731617114051 | KIRUBAKARAN K | 31 |
| 39 | 731617114054 | MANIKANDAN R | 31 |
| 40 | 731617114066 | NITHISH M | 31 |
| 41 | 731617114102 | VIGNESH R | 31 |
| 42 | 731617114000 | RAGUL S | 29 |
| 43 | 731617114015 | BUVANESVARAN S | 29 |
| 44 | 731617114063 | NAVEEN M | 29 |
| 45 | 731617114071 | PRAGATHEESWAR E | 29 |
| 46 | 731617114100 | THIRUPATHI M | 29 |
| 47 | 731617114103 | VIGNESHWARAN S | 29 |
| 48 | 731617114053 | MADESH K | 26 |
| 49 | 731617114058 | MOHANARAJ C | 26 |
| 50 | 731617114079 | RAMKUMAR B | 26 |
| 51 | 731617114088 | SASIKARAN S | 26 |

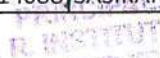
**K. B. R. INSTITUTE FOR
 ENGINEERING AND TECHNOLOGY,
 K. S. P. PALM LADAR,
 CHENNAI - 607 215,
 TAMIL NADU.**

| | | | |
|----|--------------|-----------------|----|
| 52 | 731617114095 | SURESHMOORTHY P | 26 |
| 53 | 731617114055 | MANOJ N | 23 |
| 54 | 731617114072 | PRASATH R | 23 |
| 55 | 731617114081 | SABARINATHAN S | 23 |
| 56 | 731617114085 | SARATH KUMAR M | 23 |
| 57 | 731617114059 | MONISH KANNA M | 20 |
| 58 | 731617114094 | SURESHKUMAR A | 20 |
| 59 | 731617114004 | ARUNESH J | 17 |
| 60 | 731617114070 | PRADHAP R | 17 |
| 61 | 731617114086 | SARAVANAA M | 17 |
| 62 | 731617114073 | PRATHIYUMANAN M | 9 |
| 63 | 731617114082 | SAKTHIVEL P | |
| 64 | 731617114106 | VINOTH KUMAR T | |

PRINCIPAL,
K. S. R. INSTITUTE FOR
ENGINEERING AND TECHNOLOGY,
K. S. R. KALYANAGAR,
THUDICHENGOODE - 637 215,
NAMAKKAL, TN, TAMIL NADU.

K S R INSTITUTE FOR ENGINEERING AND TECHNOLOGY
TIRUCHENGODE - 637 215

TRAINING PROGRAMME FEEDBACK FORM



Name of the Student: K. KARUPPATAH

Branch: MECHANICAL

Year / Sem: 3rd / V

1. Name of the Training :

2. Name of the Trainer : psloma

3. Students rating of Trainers :

| S. No. | Date | Subject | Rating (√) | | | |
|--------|-----------|---------|------------|-----------|------|---------|
| | | | Excellent | Very good | Good | Average |
| 1 | 22.7.2019 | | ✓ | | | |

4. Two positive points about the programme:

- * Friendly approach.
- * Explained clearly.

5. Suggestions for improvement:

Date: 22.07.2019

Signature

K S R INSTITUTE FOR ENGINEERING AND TECHNOLOGY
TIRUCHENGODE - 637 215

TRAINING PROGRAMME FEEDBACK FORM



Name of the Student: S. BUVANESEVARAN

Branch: Mechanical

Year / Sem: III / V

1. Name of the Training :

2. Name of the Trainer :

3. Students rating of Trainers :

| S. No. | Date | Subject | Rating (√) | | | |
|--------|----------|---------|------------|-----------|------|---------|
| | | | Excellent | Very good | Good | Average |
| 1 | 22.07.19 | | ✓ | | | |

4. Two positive points about the programme: * Friendly approach.

* clear explanation about the topic

5. Suggestions for improvement:

Date: 22.07.19

Signature

KSRIET
K. S. R. INSTITUTE FOR
ENGINEERING AND TECHNOLOGY,
K. S. R. KALVI NAGAR,
TIRUCHENGODE - 637 215,
NAMAKKAL DISTRICT, TAMIL NADU.

**K S R INSTITUTE FOR ENGINEERING AND TECHNOLOGY
TIRUCHENGODE - 637 215**

TRAINING PROGRAMME FEEDBACK FORM



Name of the Student: R. Govindharasu

Branch: Mech.

Year / Sem: III Year, V Sem

1. Name of the Training: Aptitude

2. Name of the Trainer: PREMA

3. Students rating of Trainers :

| S. No. | Date | Subject | Rating (√) | | | |
|--------|-----------------|---------------------|------------|-----------|------|---------|
| | | | Excellent | Very good | Good | Average |
| 1 | 23-7-19 (FN) | Profit, percentage. | | ✓ | | |

4. Two positive points about the programme:

* EASY ANALYSIS.

* Solving Shortly & Understandable.

5. Suggestions for improvement:

* Improve activities.

Date: 23-07-2019

R. Govindharasu
Signature

**K S R INSTITUTE FOR ENGINEERING AND TECHNOLOGY
TIRUCHENGODE - 637 215**

TRAINING PROGRAMME FEEDBACK FORM



Name of the Student: Arum Prabakaran

Branch: B.E - Mechanical

Year / Sem: IIIrd 05 sem

1. Name of the Training: Aptitude

2. Name of the Trainer: PREMA

3. Students rating of Trainers :

| S. No. | Date | Subject | Rating (√) | | | |
|--------|------------------|----------------------|------------|-----------|------|---------|
| | | | Excellent | Very good | Good | Average |
| 1 | 23-07-19 (AN) | Interest Calculation | | ✓ | | |

4. Two positive points about the programme:

⊗ Teaching technique is Best

5. Suggestions for improvement:

⊗ Give some more Example problems.

Date: 23-07-19

S. Arum Prabakaran
Signature

K. S. R. INSTITUTE FOR
ENGINEERING AND TECHNOLOGY,
S. R. KALLIYASAR,
TIRUCHENGODE - 637 215,
TAMIL NADU.

**K S R INSTITUTE FOR ENGINEERING AND TECHNOLOGY
TIRUCHENGODE - 637 215**

TRAINING PROGRAMME FEEDBACK FORM



Name of the Student: M. Thirupathi

Branch: Mechanical

Year / Sem: III - V

1. Name of the Training: Prema, Aptitude

2. Name of the Trainer: - ↓

3. Students rating of Trainers :

| S. No. | Date | Subject | Rating (√) | | | |
|--------|----------|---|------------|-----------|------|---------|
| | | | Excellent | Very good | Good | Average |
| 1 | 23.07.19 | Profit loss interest calculation Ratio and proportion | | ✓ | | |

4. Two positive points about the programme: My clarification of doubt is clear
friendly teaching

5. Suggestions for improvement:

Improve class control
Speak loudly

Date:

M. Thirupathi
Signature

**K S R INSTITUTE FOR ENGINEERING AND TECHNOLOGY
TIRUCHENGODE - 637 215**

TRAINING PROGRAMME FEEDBACK FORM



Name of the Student: M. Thirupathi

Branch: Mechanical

Year / Sem:

1. Name of the Training: Aptitude

2. Name of the Trainer: prema

3. Students rating of Trainers :

| S. No. | Date | Subject | Rating (√) | | | |
|--------|---------|----------------|------------|-----------|------|---------|
| | | | Excellent | Very good | Good | Average |
| 1 | 23.7.19 | Ratio & profit | | ✓ | | |

4. Two positive points about the programme:

5. Suggestions for improvement: PRINCIPAL,
K. S. R. INSTITUTE FOR
ENGINEERING AND TECHNOLOGY,
K. S. R. KALANAGAR,
TIRUCHENGODE - 637 215,
TIRUVANKAL DI, TAMIL NADU.

Date: 23.7.19

M. Thirupathi
Signature

**K S R INSTITUTE FOR ENGINEERING AND TECHNOLOGY
TIRUCHENGODE - 637 215**

TRAINING PROGRAMME FEEDBACK FORM



Name of the Student: S. Chandru

Branch: Mech

Year / Sem: III / V

1. Name of the Training: Aptitude

2. Name of the Trainer: prema

3. Students rating of Trainers :

| S. No. | Date | Subject | Rating (✓) | | | |
|--------|---------|-------------|------------|-----------|------|---------|
| | | | Excellent | Very good | Good | Average |
| 1 | 24.7.19 | Time & Work | | ✓ | | |

4. Two positive points about the programme:

friendly teaching
good approach

5. Suggestions for improvement:

Date:

S. Chandru
Signature

**K S R INSTITUTE FOR ENGINEERING AND TECHNOLOGY
TIRUCHENGODE - 637 215**

TRAINING PROGRAMME FEEDBACK FORM



Name of the Student: S. Chandru

Branch: Mechanical

Year / Sem: 3rd - V

1. Name of the Training: Aptitude

2. Name of the Trainer: Drema

3. Students rating of Trainers :

| S. No. | Date | Subject | Rating (✓) | | | |
|--------|---------|---|------------|-----------|------|---------|
| | | | Excellent | Very good | Good | Average |
| 1 | 24.7.19 | Time, Speed, distance Boat & Streams | | ✓ | | |

4. Two positive points about the programme:

friendly Teaching

5. Suggestions for improvement: friendly approach

Date:

S. Chandru
Signature

K. S. R. INSTITUTE FOR
ENGINEERING AND TECHNOLOGY,
K. S. R. ENGINEERING COLLEGE,
TIRUCHENGODE - 637 215,
NAMAKKAL DISTRICT, TAMIL NADU.

**K S R INSTITUTE FOR ENGINEERING AND TECHNOLOGY
TIRUCHENGODE - 637 215**

TRAINING PROGRAMME FEEDBACK FORM



Name of the Student: T. KARTHIKEYAN

Branch: MECHANICAL

Year / Sem: II / 5

1. Name of the Training : APTITUDE

2. Name of the Trainer : PREMA

3. Students rating of Trainers :

| S. No. | Date | Subject | Rating (✓) | | | |
|--------|------------|-------------|------------|-----------|------|---------|
| | | | Excellent | Very good | Good | Average |
| 1 | 24.07.2019 | Time & work | | | ✓ | |

4. Two positive points about the programme:

- i) Good teaching
- ii) important points are observed.

5. Suggestions for improvement:

- i) using for logic method in teaching.

Date: 24.07.2019

Signature

**K S R INSTITUTE FOR ENGINEERING AND TECHNOLOGY
TIRUCHENGODE - 637 215**

TRAINING PROGRAMME FEEDBACK FORM



Name of the Student: T. KARTHIKEYAN

Branch: MECHANICAL

Year / Sem: III / 5

1. Name of the Training : APTITUDE

2. Name of the Trainer : PREMA

3. Students rating of Trainers :

| S. No. | Date | Subject | Rating (✓) | | | |
|--------|------------|--|------------|-----------|------|---------|
| | | | Excellent | Very good | Good | Average |
| 1 | 24.07.2019 | Time, speed & distance Boats & streams | | | ✓ | |

4. Two positive points about the programme:

- i) Good teaching
- ii) Development for skills.

5. Suggestions for improvement:

- i) using logic method in teaching.

Date: 24.07.2019

Signature

K. S. R. INSTITUTE FOR
ENGINEERING AND TECHNOLOGY
TIRUCHENGODE - 637 215,
NAMAKKAL Dt, TAMIL NADU,

**K S R INSTITUTE FOR ENGINEERING AND TECHNOLOGY
TIRUCHENGODE - 637 215**

TRAINING PROGRAMME FEEDBACK FORM



Name of the Student: G. Bhagawathi Perumal Branch: Mechanical

Year / Sem: III / V

1. Name of the Training : Placement Training (Aptitude)

2. Name of the Trainer : Prema

3. Students rating of Trainers :

| S. No. | Date | Subject | Rating (✓) | | | |
|--------|----------|----------------------------|------------|-----------|------|---------|
| | | | Excellent | Very good | Good | Average |
| 1 | 25-07-19 | Probability, Comparability | ✓ | | | |

4. Two positive points about the programme:

1. 'Helpful to us' to improve our aptitude

5. Suggestions for improvement: It is difficult to understand some topics a day

Date: 25-07-19

[Signature]
Signature

**K S R INSTITUTE FOR ENGINEERING AND TECHNOLOGY
TIRUCHENGODE - 637 215**

TRAINING PROGRAMME FEEDBACK FORM



Name of the Student: S. BALAJI Branch: MECHANICAL ENGINEERING

Year / Sem: III / V

1. Name of the Training : PLACEMENT TRAINING (APTITUDE)

2. Name of the Trainer : MS. PREMA

3. Students rating of Trainers :

| S. No. | Date | Subject | Rating (✓) | | | |
|--------|----------|---------|------------|-----------|------|---------|
| | | | Excellent | Very good | Good | Average |
| 1 | 25-07-19 | | | ✓ | | |

4. Two positive points about the programme: It is very useful.

5. Suggestions for improvement: It is little difficult to understand concept

Date: 25-07-19

[Signature]
Signature

PRINCIPAL,
K. S. R. INSTITUTE FOR
ENGINEERING AND TECHNOLOGY,
K. S. R. PULI NAGAR,
TIRUCHENGODE - 637 215,
NAMAKKAL DISTRICT, TAMIL NADU.

**K S R INSTITUTE FOR ENGINEERING AND TECHNOLOGY
TIRUCHENGODE - 637 215**

TRAINING PROGRAMME FEEDBACK FORM



Name of the Student: S. Chandru

Branch: Mechanical

Year / Sem: III / IV

1. Name of the Training : placement

2. Name of the Trainer : prema

3. Students rating of Trainers :

| S. No. | Date | Subject | Rating (√) | | | |
|--------|---------|-------------------------------------|------------|-----------|------|---------|
| | | | Excellent | Very good | Good | Average |
| 1 | 26.7.19 | Synonyms, Antonyms spot error | | ✓ | | |

4. Two positive points about the programme:

good approach
providing easy method to solve problem

5. Suggestions for improvement:

-

Date:

S. Chandru
Signature

**K S R INSTITUTE FOR ENGINEERING AND TECHNOLOGY
TIRUCHENGODE - 637 215**

TRAINING PROGRAMME FEEDBACK FORM



Name of the Student: B. Gokulraj

Branch: Mechanical

Year / Sem: III / IV

1. Name of the Training : placement

2. Name of the Trainer : prema

3. Students rating of Trainers :

| S. No. | Date | Subject | Rating (√) | | | |
|--------|---------|--------------------------------------|------------|-----------|------|---------|
| | | | Excellent | Very good | Good | Average |
| 1 | 26.7.19 | Synonyms, Antonyms spot errors | ✓ | | | |

4. Two positive points about the programme:

motivation and good approach of the student

5. Suggestions for improvement:

Easy to solve the questions

Date:

B. Gokulraj
Signature

K. S. R. INSTITUTE FOR ENGINEERING AND TECHNOLOGY,
TIRUCHENGODE - 637 215,
NAMAKKAL DISTRICT, TAMIL NADU.

**K S R INSTITUTE FOR ENGINEERING AND TECHNOLOGY
TIRUCHENGODE - 637 215**

TRAINING PROGRAMME FEEDBACK FORM



Name of the Student: M. Monish Kanna

Branch: Mechanical

Year / Sem: IIIrd / V

1. Name of the Training: Verbal

2. Name of the Trainer: prema

3. Students rating of Trainers :

| S. No. | Date | Subject | Rating (√) | | | |
|--------|----------|---------|------------|-----------|------|---------|
| | | | Excellent | Very good | Good | Average |
| 1 | 27.07.19 | Verbal | ✓ | | | |

4. Two positive points about the programme:

* I developed my skills in easy way
* way of teaching is Good.

5. Suggestions for improvement:

Date: 27.07.2019

[Signature]
Signature

**K S R INSTITUTE FOR ENGINEERING AND TECHNOLOGY
TIRUCHENGODE - 637 215**

TRAINING PROGRAMME FEEDBACK FORM



Name of the Student: C. Mohanraj

Branch: Mechanical

Year / Sem: IIIrd / V

1. Name of the Training: Analogy

2. Name of the Trainer: Prema

3. Students rating of Trainers :

| S. No. | Date | Subject | Rating (√) | | | |
|--------|---------|---------|------------|-----------|------|---------|
| | | | Excellent | Very good | Good | Average |
| 1 | 27.7.19 | Analogy | ✓ | | | |

4. Two positive points about the programme:

* Simple Cratifications
* Basic of words

5. Suggestions for improvement:

Date: 27.7.19

KSRIET
PRINCIPAL,
K S R INSTITUTE FOR
ENGINEERING AND TECHNOLOGY,
TIRUCHENGODE,
NAMANGAL DQ, TIRUCHENGODE

[Signature]
Signature

K S R INSTITUTE FOR ENGINEERING AND TECHNOLOGY, TIRUCHENGODE - 637 215

TRAINING AND PLACEMENT CELL

Soft Skills Orientation Programme



Ref: KSRIET/T&P/CIR/2019-20

Date: 20.12.2019

This is to inform that all the HoD's, Class Advisor and Training and Placement coordinators that the Soft skills Orientation programme is planned for III Year Students (2017- 2021 batch) on 23.12.2019 at ECE Seminar hall by Ms A Sangeetha, Soft Skill Trainer, Central Placement Training Cell for the academic year 2019 - 2020 (Even Sem). All the Placement registered students should attend the Training Programme without fail as per the schedule given below. Proper Dress Code is mandatory.

| S.NO | Time | Department (Students Strength) |
|------|---------------------|-----------------------------------|
| 1 | 10.00 am - 11.00 am | ECE(56) |
| 2 | 11.30 am - 12.30 pm | EEE(38) |
| 3 | 01.30 pm - 02.30 pm | IT(35) |
| 4 | 02.45 pm - 03.45 pm | CSE(32) |

[Signature]
T&P OFFICER
20/12/19

[Signature]
T&P COORDINATOR
20/12/19

[Signature]
PRINCIPAL
20/12/19

Copy to:

1. All HoDs
2. Notice Board

PRINCIPAL,
K. S. R. INSTITUTE FOR
ENGINEERING AND TECHNOLOGY,
K. S. R. KALVI NAGAR,
TIRUCHENGODE - 637 215,
NAMAKKAL DL, TAMIL NADU.

K S R INSTITUTE FOR ENGINEERING AND TECHNOLOGY, Tiruchengode
Training and Placement Cell

Internal Soft Skills Development Training (Personality Development Skills)

| BATCH : 2017 - 2021 | | Trainer: Ms. A. Sangeetha | Academic Year: 2019 - 2020 |
|---------------------|--------------|---------------------------|----------------------------|
| S. No | Reg No | Name | Branch |
| 1 | 731617106003 | Alka P | ECE |
| 2 | 731617106004 | Anbazhagan K | ECE |
| 3 | 731617106006 | Balakumaran N | ECE |
| 4 | 731617106007 | Booma V | ECE |
| 5 | 731617106008 | Daranidaran R S | ECE |
| 6 | 731617106011 | Dhanushkodi N | ECE |
| 7 | 731617106012 | Dharnish K | ECE |
| 8 | 731617106015 | Dinnesh P | ECE |
| 9 | 731617106017 | Gokulnath N | ECE |
| 10 | 731617106019 | Gowtham M | ECE |
| 11 | 731617106020 | Hari Hara Sudhan R | ECE |
| 12 | 731617106021 | Harikrishnan M | ECE |
| 13 | 731617106023 | Hemaharini S | ECE |
| 14 | 731617106025 | Janarth S | ECE |
| 15 | 731617106028 | Kamaleshwaran R | ECE |
| 16 | 731617106029 | Kamalini N | ECE |
| 17 | 731617106030 | Karthika C | ECE |
| 18 | 731617106031 | Keerthana S | ECE |
| 19 | 731617106032 | Keerthivasan N | ECE |
| 20 | 731617106033 | Kishor M | ECE |
| 21 | 731617106034 | Kishore D | ECE |
| 22 | 731617106036 | Madhangopal C | ECE |
| 23 | 731617106037 | Manimala R | ECE |
| 24 | 731617106038 | Manjula T | ECE |
| 25 | 731617106039 | Merin Kumar L | ECE |
| 26 | 731617106041 | Muthulakshmi S | ECE |
| 27 | 731617106701 | Aravinth(Transfer) | ECE |
| 28 | 731617106043 | Naveen S S | ECE |
| 29 | 731617106045 | Parkavi P | ECE |
| 30 | 731617106046 | Parkavi S | ECE |
| 31 | 731617106047 | Pavithra T | ECE |
| 32 | 731617106048 | Premela R | ECE |
| 33 | 731617106050 | Priyanka V | ECE |
| 34 | 731617106051 | Raghuramachandiran V | ECE |
| 35 | 731617106052 | Ramya S | ECE |
| 36 | 731617106055 | Ruban Prasad J | ECE |
| 37 | 731617106057 | Santhiya T | ECE |
| 38 | 731617106058 | Santhiya Y | ECE |

K S R INSTITUTE FOR ENGINEERING AND TECHNOLOGY,
 K. S. R. NAGAR,
 TIRUCHENGODE - 637 215,
 NAMBARKAL DISTRICT, TAMIL NADU.

| S. No | Reg No | Name | Branch |
|-------|--------------|-------------------|--------|
| 39 | 731617106061 | Shanmathi M M | ECE |
| 40 | 731617106062 | Sharumathi S | ECE |
| 41 | 731617106063 | Sinduja K | ECE |
| 42 | 731617106067 | Sreemathi G | ECE |
| 43 | 731617106069 | Srinivasan A | ECE |
| 44 | 731617106070 | Srinivasan S R | ECE |
| 45 | 731617106071 | Sri Ranjani S | ECE |
| 46 | 731617106073 | Subash K | ECE |
| 47 | 731617106074 | Sudha G | ECE |
| 48 | 731617106075 | Sukhesan C | ECE |
| 49 | 731617106077 | Suryapriya K | ECE |
| 50 | 731617106079 | Sweetlin Joshva A | ECE |
| 51 | 731617106080 | Swetha G P | ECE |
| 52 | 731617106081 | Tamilzhagan G | ECE |
| 53 | 731617106082 | Tejaswini S | ECE |
| 54 | 731617106084 | Thiyagu M | ECE |
| 55 | 731617106086 | Yasodha P | ECE |
| 56 | 731617106087 | Yuvansankar K | ECE |

PRINCIPAL,
K. S. R. INSTITUTE FOR
ENGINEERING AND TECHNOLOGY,
K. S. R. KALVI NAGAR,
TIRUCHENGOODE - 637 215,
KAMARAJAL DI, TAMIL NADU.

K S R INSTITUTE FOR ENGINEERING AND TECHNOLOGY, Tiruchengode
Training and Placement Cell

Internal Soft Skills Development Training (Personality Development Skills)

| BATCH : 2017 - 2021 | | Trainer: Ms. A. Sangeetha | Academic Year: 2019 - 2020 |
|----------------------------|--------------|---------------------------|----------------------------|
| Date of Training Programme | | | |
| S.No | Reg No | Name | Branch |
| 1 | 731617205001 | AJAY SRIRAM K | IT |
| 2 | 731617205002 | ARUL MOZHI M | IT |
| 3 | 731617205003 | BABU U S | IT |
| 4 | 731617205004 | BALAMURUGAN S | IT |
| 5 | 731617205007 | DHINAKARAN K | IT |
| 6 | 731617205010 | GIRINATH S | IT |
| 7 | 731617205011 | GOBIKA M | IT |
| 8 | 731617205012 | HARIHARAN | IT |
| 9 | 731617205013 | HARI PRASATH K | IT |
| 10 | 731617205014 | JESSICA COLLINS | IT |
| 11 | 731617205016 | JOTHEESHWARAN R | IT |
| 12 | 731617205018 | KALIDASS R | IT |
| 13 | 731617205019 | KANNAN P | IT |
| 14 | 731617205021 | KARTHIK T | IT |
| 15 | 731617205025 | LAKSHMANAN R | IT |
| 16 | 731617205026 | MANIKANDAN A | IT |
| 17 | 731617205027 | MOUNISH G | IT |
| 18 | 731617205030 | NANDHINI S | IT |
| 19 | 731617205031 | NATHIYA V | IT |
| 20 | 731617205033 | NAVEENKUMAR G | IT |
| 21 | 731617205035 | PAVITHRA S | IT |
| 22 | 731617205036 | PRIYADHARSHINI P | IT |
| 23 | 731617205039 | SAANTHOSH BALAJI S N | IT |
| 24 | 731617205040 | SANDHIYA G | IT |
| 25 | 731617205042 | SARAN V | IT |
| 26 | 731617205044 | SATHISHKUMAR V | IT |
| 27 | 731617205045 | SELVAMALAR P | IT |
| 28 | 731617205046 | SHAILAA P M | IT |
| 29 | 731617205047 | SHIVANI N | IT |
| 30 | 731617205048 | SIVASANKARI R | IT |
| 31 | 731617205049 | SREEMATHI INDRA S | IT |
| 32 | 731617205051 | THANEESWARAN Y G | IT |
| 33 | 731617205052 | THUSMEENA K R | IT |
| 34 | 731617205053 | VENKATESWARAN S | IT |
| 35 | 731617205055 | VINOTHINI R | IT |

PRINCIPAL,
K. S. R. INSTITUTE FOR
ENGINEERING AND TECHNOLOGY,
K. S. R. ROAD,
TIRUCHENGODE - 637 215,
NAMAKKAL DISTRICT, TAMIL NADU.

K S R INSTITUTE FOR ENGINEERING AND TECHNOLOGY, Tiruchengode
Training and Placement Cell

Internal Soft Skills Development Training (Personality Development Skills)

| BATCH : 2017 - 2021 | | Trainer: Ms. A. Sangeetha | Academic Year: 2019 - 2020 |
|---------------------|--------------|---------------------------|----------------------------|
| S. No | Reg No | Name | Branch |
| 1 | 731617104002 | AGILAN R | CSE |
| 2 | 731617104004 | ARUN KUMAR N | CSE |
| 3 | 731617104005 | BABU R | CSE |
| 4 | 731617104007 | CHOWMIYA S B | CSE |
| 5 | 731617104009 | DERIL CHARLESS K | CSE |
| 6 | 731617104012 | DINESHKUMAR K | CSE |
| 7 | 731617104014 | GAYATHRI M | CSE |
| 8 | 731617104015 | GAYATHRI M | CSE |
| 9 | 731617104016 | GOWTHAM G | CSE |
| 10 | 731617104020 | HARISH P | CSE |
| 11 | 731617104021 | KAILASH K | CSE |
| 12 | 731617104024 | KISHOR P | CSE |
| 13 | 731617104025 | KOTEESHWARAN P N | CSE |
| 14 | 731617104026 | KRISHNAMOORTHY S | CSE |
| 15 | 731617104028 | MARIMUTHU R | CSE |
| 16 | 731617104034 | POOJA M | CSE |
| 17 | 731617104035 | POOJA SHREE K | CSE |
| 18 | 731617104039 | PRASANTH T | CSE |
| 19 | 731617104042 | SANGEETHA M | CSE |
| 20 | 731617104043 | SANTHOSHKUMAR | CSE |
| 21 | 731617104045 | SHARMILA A | CSE |
| 22 | 731617104046 | SNEHA P | CSE |
| 23 | 731617104050 | VAISHNAVI V | CSE |
| 24 | 731617104051 | VALENTEENA COLLINS J P | CSE |
| 25 | 731617104052 | VEERALAKSHMI S | CSE |
| 26 | 731617104054 | VIGNESH S | CSE |
| 27 | 731617104058 | YUVASHREE R | CSE |
| 28 | 731617104013 | ELANGO M | CSE |
| 29 | 731617104017 | GUNA M | CSE |
| 30 | 731617104701 | MADHAN KUMAR | CSE |
| 31 | 731617104702 | DEEPAK J | CSE |
| 32 | 731617104023 | KESAVAN S | CSE |

 PRINCIPAL,
 K. S. R. INSTITUTE FOR
 ENGINEERING AND TECHNOLOGY
 K. S. R. INSTITUTE ROAD,
 TIRUCHENGODE - 637 215,
 NAMAKKAL Dt, TAMIL NADU.

K S R INSTITUTE FOR ENGINEERING AND TECHNOLOGY, Tiruchengode

Training and Placement Cell

Internal Soft Skills Development Training (Personality Development Skills)

| BATCH : 2017 - 2021 | | Trainer: Ms. A. Sangeetha | Academic Year: 2019 - 2020 |
|---------------------|--------------|---------------------------|----------------------------|
| S. No | Reg No | Name | Branch |
| 1 | 731617105002 | ASHA R | EEE |
| 2 | 731617105052 | THAMIZHSELVAN R | EEE |
| 3 | 731617105013 | JEEVANANDAM T | EEE |
| 4 | 731617105024 | MOHAN T | EEE |
| 5 | 731617105010 | HARI S R | EEE |
| 6 | 731617105036 | SAKTHIVEL P | EEE |
| 7 | 731617105018 | KAVINKUMAR M | EEE |
| 8 | 731617105040 | SASIKUMAR C | EEE |
| 9 | 731617105008 | GOWTHAM S P | EEE |
| 10 | 731617105037 | SANTHOSHKUMAR K | EEE |
| 11 | 731617105027 | PARAMASIVAM R | EEE |
| 12 | 731617105016 | KAMALAHASAN G | EEE |
| 13 | 731617105022 | MANJUPRIYA M | EEE |
| 14 | 731617105034 | RAMYA A | EEE |
| 15 | 731617105019 | KAVIN MUTHU KUMAR S | EEE |
| 16 | 731617105044 | SHYAM PRASHAD S | EEE |
| 17 | 731617105005 | DINESH C | EEE |
| 18 | 731617105055 | VINOTH KUMAR R | EEE |
| 19 | 731617105031 | PRAVEEN KUMAR A | EEE |
| 20 | 731617105038 | SARANSARVESH M | EEE |
| 21 | 731617105012 | JAYASURYA K | EEE |
| 22 | 731617105023 | MANOJ KUMAR S | EEE |
| 23 | 731617105020 | KIRUBAKAR S | EEE |
| 24 | 731617105042 | SHAMEER S | EEE |
| 25 | 731617105001 | ARUL M | EEE |
| 26 | 731617105041 | SELVAM B | EEE |
| 27 | 731617105004 | BHARATH S | EEE |
| 28 | 731617105009 | GUGANESH R | EEE |
| 29 | 731617105017 | KARTHIKEYAN M | EEE |
| 30 | 731617105025 | NANDAKUMAARAN S | EEE |
| 31 | 731617105028 | PERARIVU EZHIL ARASAN T | EEE |
| 32 | 731617105032 | PRAVEEN KUMAR M | EEE |
| 33 | 731617105045 | SILAMBARASAN S | EEE |
| 34 | 731617105046 | SUJITH S (11.02.2000) | EEE |
| 35 | 731617105047 | SUJITH S | EEE |
| 36 | 731617105049 | SURESH P | EEE |
| 37 | 731617105050 | SURYA P | EEE |
| 38 | 731617105054 | VENKATESAN M | EEE |

 PRINCIPAL,
 K. S. R. INSTITUTE FOR
 ENGINEERING AND TECHNOLOGY,
 K. S. R. INSTITUTE FOR
 TIRUCHENGOODE - 627 245,
 NAIYAKKAL DI, TAMIL NADU.

FW: EXTRAMARKS- KSRIET students performance analysis

Mr. Jegadeesan Palaniswamy <jegadeesan@ksrei.org>

Thu 1/9/2020 11:15 AM

To: training@ksriet.ac.in <training@ksriet.ac.in>; itselva88@gmail.com <itselva88@gmail.com>

Cc: KSRI Educational Institutions - Placement <placement@ksrei.org>; Dr. Venkatesan V <venkatesan@ksrei.org>

From: Sangeetha A <sangeetha.a@ksrei.org>

Sent: Thursday, January 9, 2020 10:16 AM

To: Mr. Jegadeesan Palaniswamy <jegadeesan@ksrei.org>

Subject: EXTRAMARKS- KSRIET students performance analysis

Hello,

Kindly find the attached list of students performance analysed in EXTRAMARKS training session held on 07.01.2020(Tuesday).

| Names | Dept | College | Strength | Areas to improve |
|----------------------|------|---------|--|---|
| Naresh Kumar S | ECE | KSRIET | | eye contact should be with all the participant not with evaluator alone, confidence |
| Ananda Krishnan P | ECE | KSRIET | | confidence, body language, communication |
| Venmathi S | CSE | KSRIET | | participation, communication |
| Srimathi G | ECE | KSRIET | | communication, participation |
| Bhuvaneshwari P | ECE | KSRIET | greeting, clarity, subject knowledge, ownership | confidence |
| Sella Krishna Raja S | ECE | KSRIET | initiation | confidence, breaking knuckles |
| Ramya Sri E | ECE | KSRIET | | |
| Swetha S | CSE | KSRIET | body language | hesitation, participation, content |
| Priya Dharshini P | ECE | KSRIET | content | initiation, confidence, participation |
| Brindha M | ECE | KSRIET | clarity, communication, accent, completeness, subject knowledge | |
| Marimuthu M | ECE | KSRIET | initiation | shaking legs, body language, communication |
| Showmiya M | ECE | KSRIET | | participation, communication |
| Akshaya N M | ECE | KSRIET | | participation, confidence, content |
| Swetha S | IT | KSRIET | subject knowledge, participation | clarity, confidence |
| Arun | CSE | KSRIET | greeting, clarity, subject knowledge, body language, communication | fillers, confidence |
| Sumathi S | ECE | KSRIET | clarity, confidence, participation | confidence, legs stretch out, filler |
| NavaNanthini E | ECE | KSRIET | clarity, | participation, communication |
| Malathi A S | ECE | KSRIET | communication, body language | crossed legs |
| Thangavel P | ECE | KSRIET | greeting, paraphrasing, confidence, clarity, communication, accent | sitting posture |
| Pugazhi Velan P | CSE | KSRIET | participation, content | confidence, stammer, clarity, initiation, don't say that's all, using filler |
| Jaya Varshini G | CSE | KSRIET | | clarity, stammer, shaking legs, communication |
| Kokila K | ECE | KSRIET | | confidence, communication |
| Meena A | ECE | KSRIET | | break knuckles, communication |

Regards,
Sangeetha A

PRINCIPAL,
K. S. R. INSTITUTE FOR
ENGINEERING AND TECHNOLOGY,
K. S. R. KALM HALL,
TIRUCHENGODE - 637 215,
NAMAKKAL DI, TAMIL NADU.

 09/01/2020

K S R INSTITUTE FOR ENGINEERING AND TECHNOLOGY
TIRUCHENGODE - 637 215

TRAINING PROGRAMME FEEDBACK FORM



Name of the Student: ALKA - P Branch: ECE

Year / Sem: III / IV [IV]

1. Name of the Training: SOFT SKILLS DEVELOPMENT [PSD]

2. Name of the Trainer: MS. SAMBETHA

3. Students rating of Trainers :

| S. No. | Date | Subject | Rating (✓) | | | |
|--------|----------|---------|------------|-----------|------|---------|
| | | | Excellent | Very good | Good | Average |
| 1 | 23/12/19 | PSD | ✓ | | | |

4. Two positive points about the programme:

WAY TO TEACHING , VERY INTERESTING

5. Suggestions for improvement:

Date: 23/12/19

P. ALKA
Signature

K S R INSTITUTE FOR ENGINEERING AND TECHNOLOGY
TIRUCHENGODE - 637 215

TRAINING PROGRAMME FEEDBACK FORM



Name of the Student: PAVITHRA.T Branch: ECE

Year / Sem: III / IV

1. Name of the Training: SOFT SKILLS DEVELOPMENT [PSD]

2. Name of the Trainer: MS. SANGEETHA

3. Students rating of Trainers :

| S. No. | Date | Subject | Rating (✓) | | | |
|--------|----------|---------|------------|-----------|------|---------|
| | | | Excellent | Very good | Good | Average |
| 1 | 23/12/19 | PSD | | ✓ | | |

4. Two positive points about the programme: I gained knowledge from this session

5. Suggestions for improvement:

Date: 23/12/19

Aruga
Signature

K S R INSTITUTE FOR ENGINEERING AND TECHNOLOGY
TIRUCHENGODE - 637 215

TRAINING PROGRAMME FEEDBACK FORM



Name of the Student: MOHAN T

Branch: EEE

Year / Sem: III / IV

1. Name of the Training : PSD

2. Name of the Trainer : SAGEETHA

3. Students rating of Trainers :

| S. No. | Date | Subject | Rating (✓) | | | |
|--------|----------|---------|------------|-----------|------|---------|
| | | | Excellent | Very good | Good | Average |
| 1 | 23/12/19 | PSD | ✓ | | | |

4. Two positive points about the programme: very useful session

5. Suggestions for improvement:

Date: 23.12.19

moheem
Signature

K S R INSTITUTE FOR ENGINEERING AND TECHNOLOGY
TIRUCHENGODE - 637 215

TRAINING PROGRAMME FEEDBACK FORM



Name of the Student: Anil M

Branch: DEE

Year / Sem: III / IV

1. Name of the Training : PSD

2. Name of the Trainer : Ms. Sangeetha

3. Students rating of Trainers :

| S. No. | Date | Subject | Rating (✓) | | | |
|--------|----------|---------|------------|-----------|------|---------|
| | | | Excellent | Very good | Good | Average |
| 1 | 23/12/19 | PSD | ✓ | | | |

4. Two positive points about the programme:

Cleanly Understood my Personality

5. Suggestions for improvement:

Date: 23/12/19

Anil M
Signature

K S R INSTITUTE FOR ENGINEERING AND TECHNOLOGY
TIRUCHENGODE - 637 215

TRAINING PROGRAMME FEEDBACK FORM



Name of the Student: JESSICA COLLINS Branch: IT

Year / Sem: III / IV

1. Name of the Training: SOFT SKILLS

2. Name of the Trainer: SAMEETHA

3. Students rating of Trainers :

| S. No. | Date | Subject | Rating (✓) | | | |
|--------|----------|-------------|------------|-----------|------|---------|
| | | | Excellent | Very good | Good | Average |
| 1 | 23/12/19 | SOFT SKILLS | | | | |

4. Two positive points about the programme:

SSD & PSD I learned more in this session

5. Suggestions for improvement:

Date: 23/12/19

Jessica Collins
Signature

K S R INSTITUTE FOR ENGINEERING AND TECHNOLOGY
TIRUCHENGODE - 637 215

TRAINING PROGRAMME FEEDBACK FORM



Name of the Student: SHANMUKHI Branch: IT

Year / Sem: III / IV

1. Name of the Training: soft skills

2. Name of the Trainer: SAGEETHA

3. Students rating of Trainers :

| S. No. | Date | Subject | Rating (✓) | | | |
|--------|----------|-------------|------------|-----------|------|---------|
| | | | Excellent | Very good | Good | Average |
| 1 | 23/12/19 | soft skills | | ✓ | | |

4. Two positive points about the programme:

5. Suggestions for improvement: this I gained more information from session

Date: 23/12/19

Shanmukhi
Signature

K S R INSTITUTE FOR ENGINEERING AND TECHNOLOGY
TIRUCHENGODE - 637 215

TRAINING PROGRAMME FEEDBACK FORM



Name of the Student: Harish P Branch: CSE
Year / Sem: III / IV

1. Name of the Training: Soft skills
2. Name of the Trainer: Sangeetha
3. Students rating of Trainers :

| S. No. | Date | Subject | Rating (√) | | | |
|--------|----------|-------------|------------|-----------|------|---------|
| | | | Excellent | Very good | Good | Average |
| 1 | 23/12/19 | SOFT SKILLS | ✓ | | | |

4. Two positive points about the programme:
SDP & PSD learned more in this session.
5. Suggestions for improvement:

Date: 23/12/19 Signature: Harish

K S R INSTITUTE FOR ENGINEERING AND TECHNOLOGY
TIRUCHENGODE - 637 215

TRAINING PROGRAMME FEEDBACK FORM



Name of the Student: POOJA M Branch: CSE
Year / Sem: III / IV

1. Name of the Training: Soft skills
2. Name of the Trainer: Sangeetha
3. Students rating of Trainers :

| S. No. | Date | Subject | Rating (√) | | | |
|--------|----------|-------------|------------|-----------|------|---------|
| | | | Excellent | Very good | Good | Average |
| 1 | 23/12/19 | Soft skills | ✓ | | | |

4. Two positive points about the programme:
Informative session
5. Suggestions for improvement:

Date: 23/12/19 Signature: Pooja

TRAINING AND PLACEMENT CELL



Two Days Soft Skills Workshop

Ref: KSRIET/T&P/CIR/2019-20

Date: 06.01.2020

This is to inform that all the HoD's, Class Advisor and Training and Placement coordinators that the Two days Soft skills workshop is planned for III Year students topics on "Imparting the Skills of Effective Communication and Professional Etiquettes" (2017- 2021 batch) on 08.01.2020 & 09.01.2020 at ECE Seminar Hall by Dr Sumita Roy, Osmania University & Dr. Muhuntaraju AP/Eng for the academic year 2019 – 2020 (Even Sem). All the Registered students should attend the Workshop without fail.

| S.NO | Date & Time | Eligible Students Count |
|------|-------------------------------|---|
| 1 | 08.01.2020 & 09.01.2020 | CSE - 10, ECE - 16, EEE - 10, IT- 10 & MECH- 10 Total - 56 |

Y. Kalu
T&P OFFICER

[Signature]
T&P COORDINATOR

[Signature]
PRINCIPAL

Copy to:

1. All HoDs
2. Notice Board

[Green Stamp]
PRINCIPAL,
K. S. R. INSTITUTE FOR
ENGINEERING AND TECHNOLOGY,
K. S. R. VADALI NAGAR,
TIRUCHENGODE - 637 215,
NAMAKKAL Dt, TAMIL NADU.

K S R INSTITUTE FOR ENGINEERING AND TECHNOLOGY, Tiruchengode

Training and Placement Cell

Department of English

Workshop on Imparting the Skills of Effective Communication and Professional Etiquettes

BATCH : 2017 - 2021

Academic Year: 2019 - 2020

| S. No | Reg No | Name | Branch | 08.01.2020 | | 09.01.2020 | |
|-------|--------------|------------------------|--------|------------|----|------------|----|
| | | | | FN | AN | FN | AN |
| 1 | 731617104004 | ARUN KUMAR N | CSE | / | / | / | / |
| 2 | 731617104007 | CHOWMIYA S B | CSE | / | / | / | / |
| 3 | 731617104014 | GAYATHRI M | CSE | / | / | / | / |
| 4 | 731617104028 | MARIMUTHU R | CSE | / | / | / | / |
| 5 | 731617104039 | PRASANTH T | CSE | / | / | / | / |
| 6 | 731617104037 | PRAKASH V | CSE | / | / | / | / |
| 7 | 731617104042 | SANGEETHA M | CSE | / | / | / | / |
| 8 | 731617104043 | SANTHOSHKUMAR | CSE | / | / | / | / |
| 9 | 731617104051 | VALENTEENA COLLINS J P | CSE | / | / | / | / |
| 10 | 731617104054 | VIGNESH S | CSE | / | / | / | / |
| 11 | 731617106003 | Alka P | ECE | / | / | / | / |
| 12 | 731617106008 | Daranidaran R S | ECE | / | / | / | / |
| 13 | 731617106011 | Dhanushkodi N | ECE | / | / | / | / |
| 14 | 731617106015 | Dinnesh P | ECE | / | / | / | / |
| 15 | 731617106019 | Gowtham M | ECE | / | / | / | / |
| 16 | 731617106020 | Hari Hara Sudhan R | ECE | / | / | / | / |
| 17 | 731617106028 | Kamaleshwaran R | ECE | / | / | / | / |
| 18 | 731617106031 | Keerthana S | ECE | / | / | / | / |
| 19 | 731617106051 | Raghuramachandiran V | ECE | / | / | / | / |
| 20 | 731617106055 | Ruban Prasad J | ECE | / | / | / | / |
| 21 | 731617106061 | Shanmathi M M | ECE | / | / | / | / |
| 22 | 731617106062 | Sharumathi S | ECE | / | / | / | / |
| 23 | 731617106063 | Sinduja K | ECE | / | / | A | A |
| 24 | 731617106071 | Sri Ranjani S | ECE | / | / | / | / |
| 25 | 731617106077 | Suryapriya K | ECE | / | / | / | / |
| 26 | 731617106079 | Sweetlin Joshva A | ECE | / | / | / | / |
| 27 | 731617105002 | ASHA R | EEE | / | / | / | / |

 K. S. R. INSTITUTE FOR ENGINEERING AND TECHNOLOGY,
 TIRUCHENGODE, TAMIL NADU.
 K. S. R. INSTITUTE FOR ENGINEERING AND TECHNOLOGY,
 TIRUCHENGODE, TAMIL NADU.
 K. S. R. INSTITUTE FOR ENGINEERING AND TECHNOLOGY,
 TIRUCHENGODE, TAMIL NADU.

| S. No | Reg No | Name | Branch | 08.01.2020 | | 09.01.2020 | |
|---------|--------------|----------------------|--------|------------|----|------------|----|
| | | | | FN | AN | FN | AN |
| 28 | 731617105052 | THAMIZHSELVAN R | EEE | / | / | / | / |
| 29 | 731617105013 | JEEVANANDAM T | EEE | / | / | / | / |
| 30 | 731617105024 | MOHAN T | EEE | / | / | / | / |
| 31 | 731617105036 | SAKTHIVEL P | EEE | / | / | / | / |
| 32 | 731617105027 | PARAMASIVAM R | EEE | / | / | / | / |
| 33 | 731617105016 | KAMALAHASAN G | EEE | / | / | / | / |
| 34 | 731617105019 | KAVIN MUTHU KUMAR S | EEE | / | / | / | / |
| 35 | 731617105038 | SARANSARVESH M | EEE | / | / | / | / |
| 36 | 731617105047 | SUJITH S | EEE | / | / | / | / |
| 37 | 731617205002 | ARUL MOZHI M | IT | / | / | / | / |
| 38 | 731617205013 | HARI PRASATH K | IT | / | / | / | / |
| 39 | 731617205026 | MANIKANDAN A | IT | / | / | / | / |
| 40 | 731617205030 | NANDHINI S | IT | / | / | / | / |
| 41 | 731617205040 | SANDHIYA G | IT | / | / | / | / |
| 42 | 731617205045 | SELVAMALAR P | IT | / | / | / | / |
| 43 | 731617205046 | SHAILAA P M | IT | / | / | / | / |
| 44 | 731617205047 | SHIVANI N | IT | / | / | / | / |
| 45 | 731617205048 | SIVASANKARI R | IT | / | / | / | / |
| 46 | 731617205053 | VENKATESWARAN S | IT | / | / | / | / |
| 47 | 731617114011 | BHAGAVATHI PERUMAL G | MECH A | / | / | A | A |
| 48 | 731617114018 | CHANDRU S | MECH A | / | / | / | / |
| 49 | 731617114033 | HARIHARAN G | MECH A | / | / | A | A |
| 50 | 731617114038 | JAGATHESHWARAN N | MECH A | / | / | / | / |
| 51 | 731617114051 | KIRUBAKARAN K | MECH A | / | / | / | / |
| 52 | 731617114077 | PREMRAJ S | MECH B | / | / | / | / |
| 53 | 731617114081 | SABARINATHAN S | MECH B | / | / | / | / |
| 54 | 731617114086 | SARAVANAA M | MECH B | / | / | A | A |
| 55 | 731617114093 | SURENDHAR P | MECH B | / | / | A | A |
| 56 | 731617114094 | SURESHKUMAR A | MECH B | / | / | / | / |
| PRESENT | | | | 56 | 56 | 51 | 51 |
| ABSENT | | | | 0 | 0 | 5 | 5 |

K S R INSTITUTE FOR ENGINEERING AND TECHNOLOGY, Tiruchengode

Training and Placement Cell

Department of English

Workshop on Imparting the Skills of Effective Communication and Professional Etiquettes

BATCH : 2017 - 2021

Academic Year: 2019 - 2020

| S. No | Reg No | Name | Branch | 08.01.2020 | | 09.01.2020 | |
|-------|--------------|------------------------|--------|------------|----|------------|----|
| | | | | FN | AN | FN | AN |
| 1 | 731617104004 | ARUN KUMAR N | CSE | / | / | / | / |
| 2 | 731617104007 | CHOWMIYA S B | CSE | / | / | / | / |
| 3 | 731617104014 | GAYATHRI M | CSE | / | / | / | / |
| 4 | 731617104028 | MARIMUTHU R | CSE | / | / | / | / |
| 5 | 731617104039 | PRASANTH T | CSE | / | / | / | / |
| 6 | 731617104037 | PRAKASH V | CSE | / | / | / | / |
| 7 | 731617104042 | SANGEETHA M | CSE | / | / | / | / |
| 8 | 731617104043 | SANTHOSHKUMAR | CSE | / | / | / | / |
| 9 | 731617104051 | VALENTEENA COLLINS J P | CSE | / | / | / | / |
| 10 | 731617104054 | VIGNESH S | CSE | / | / | / | / |
| 11 | 731617106003 | Alka P | ECE | / | / | / | / |
| 12 | 731617106008 | Daranidaran R S | ECE | / | / | / | / |
| 13 | 731617106011 | Dhanushkodi N | ECE | / | / | / | / |
| 14 | 731617106015 | Dinnesh P | ECE | / | / | / | / |
| 15 | 731617106019 | Gowtham M | ECE | / | / | / | / |
| 16 | 731617106020 | Hari Hara Sudhan R | ECE | / | / | / | / |
| 17 | 731617106028 | Kamaleshwaran R | ECE | / | / | / | / |
| 18 | 731617106031 | Keerthana S | ECE | / | / | / | / |
| 19 | 731617106051 | Raghuramachandiran V | ECE | / | / | / | / |
| 20 | 731617106055 | Ruban Prasad J | ECE | / | / | / | / |
| 21 | 731617106061 | Shanmathi M M | ECE | / | / | / | / |
| 22 | 731617106062 | Sharumathi S | ECE | / | / | / | / |
| 23 | 731617106063 | Sinduja K | ECE | / | / | A | A |
| 24 | 731617106071 | Sri Ranjani S | ECE | / | / | / | / |
| 25 | 731617106077 | Suryapriya K | ECE | / | / | / | / |
| 26 | 731617106079 | Sweetlin Joshva A | ECE | / | / | / | / |
| 27 | 731617105002 | ASHA R | EEE | / | / | / | / |

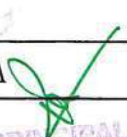
 PRINCIPAL,
 K. S. R. INSTITUTE FOR
 ENGINEERING AND TECHNOLOGY,
 K. S. R. COLLEGE ROAD,
 TIRUCHENGODE - 637 215,
 TAMIL NADU.

| S. No | Reg No | Name | Branch | 08.01.2020 | | 09.01.2020 | |
|---------|--------------|----------------------|--------|------------|----|------------|----|
| | | | | FN | AN | FN | AN |
| 28 | 731617105052 | THAMIZHSELVAN R | EEE | / | / | / | / |
| 29 | 731617105013 | JEEVANANDAM T | EEE | / | / | / | / |
| 30 | 731617105024 | MOHAN T | EEE | / | / | / | / |
| 31 | 731617105036 | SAKTHIVEL P | EEE | / | / | / | / |
| 32 | 731617105027 | PARAMASIVAM R | EEE | / | / | / | / |
| 33 | 731617105016 | KAMALAHASAN G | EEE | / | / | / | / |
| 34 | 731617105019 | KAVIN MUTHU KUMAR S | EEE | / | / | / | / |
| 35 | 731617105038 | SARANSARVESH M | EEE | / | / | / | / |
| 36 | 731617105047 | SUJITH S | EEE | / | / | / | / |
| 37 | 731617205002 | ARUL MOZHI M | IT | / | / | / | / |
| 38 | 731617205013 | HARI PRASATH K | IT | / | / | / | / |
| 39 | 731617205026 | MANIKANDAN A | IT | / | / | / | / |
| 40 | 731617205030 | NANDHINI S | IT | / | / | / | / |
| 41 | 731617205040 | SANDHIYA G | IT | / | / | / | / |
| 42 | 731617205045 | SELVAMALAR P | IT | / | / | / | / |
| 43 | 731617205046 | SHAILAA P M | IT | / | / | / | / |
| 44 | 731617205047 | SHIVANI N | IT | / | / | / | / |
| 45 | 731617205048 | SIVASANKARI R | IT | / | / | / | / |
| 46 | 731617205053 | VENKATESWARAN S | IT | / | / | / | / |
| 47 | 731617114011 | BHAGAVATHI PERUMAL G | MECH A | / | / | A | A |
| 48 | 731617114018 | CHANDRU S | MECH A | / | / | / | / |
| 49 | 731617114033 | HARIHARAN G | MECH A | / | / | A | A |
| 50 | 731617114038 | JAGATHESHWARAN N | MECH A | / | / | / | / |
| 51 | 731617114051 | KIRUBAKARAN K | MECH A | / | / | / | / |
| 52 | 731617114077 | PREMRAJ S | MECH B | / | / | / | / |
| 53 | 731617114081 | SABARINATHAN S | MECH B | / | / | / | / |
| 54 | 731617114086 | SARAVANAA M | MECH B | / | / | A | A |
| 55 | 731617114093 | SURENDHAR P | MECH B | / | / | A | A |
| 56 | 731617114094 | SURESHKUMAR A | MECH B | / | / | / | / |
| PRESENT | | | | 56 | 56 | 51 | 51 |
| ABSENT | | | | 0 | 0 | 5 | 5 |



One Day Company Specific Soft Skills Training Programme

Ref: KSRIET/T&P/CIR/2019-20

Date: 03.01.2020

This is to inform that all the HoD's, Class Advisor and Training and Placement coordinators that the one day Company Specific Soft skills Training programme is planned for IV Year Extramarks Education India Pvt. Ltd drive Eligible Students (2016- 2020 batch) on 17.01.2020 at KSREI, IT Park by Ms A Sangeetha, Soft Skill Trainer, Central Placement Training Cell for the academic year 2019 - 2020 (Even Sem). All the Eligible students should attend the Training Programme without fail as per the schedule given below. Proper Dress Code is mandatory.

| S.NO | Date & Time | Eligible Students Count |
|------|--|---|
| 1 | 17.01.2020 & 09.00 am - 04.00 am | CSE - 8, ECE - 16 & IT- 1 Total - 27 |

T&P OFFICER

3/1/20
T&P COORDINATOR

3/1/20
PRINCIPAL

Copy to:

1. All HoDs
2. Notice Board

PRINCIPAL,
K. S. R. INSTITUTE FOR
ENGINEERING AND TECHNOLOGY,
K. S. R. SANGHARAGAR,
TIRUCHENGODE - 637 215,
NAMAKKAL DI, TAMIL NADU.

Training and Placement Cell

Softskill Trainnig Programme for Extramarks Education India Pvt. Ltd drive

| Name of The Trainer: Ms A Sangeetha, Soft Skill Trainer, Central Placement Training Cell | | | | |
|--|--------------|--------------------|--------|------------|
| S.No | Reg.No | Name | Branch | 17.01.2020 |
| 1 | 731616106005 | AKSHAYA N M | ECE | P |
| 2 | 731616106007 | ANANTHA KRISHNAN P | ECE | P |
| 3 | 731616106013 | BHUVANESHWARI P | ECE | P |
| 4 | 731616106015 | BRINDHA M | ECE | P |
| 5 | 731616106029 | JAYASHRI M | ECE | A |
| 6 | 731616106034 | KOKILA K | ECE | P |
| 7 | 731616106038 | MALATHI A S | ECE | P |
| 8 | 731616106039 | MARIMUTHU M | ECE | P |
| 9 | 731616106040 | MEENA A | ECE | P |
| 10 | 731616106302 | E.NAVANANDHINI | ECE | P |
| 11 | 731616106047 | NARESHKUMAR S | ECE | P |
| 12 | 731616106055 | PRIYADHARSHNI P | ECE | P |
| 13 | 731616106058 | RAMYA SRI E | ECE | P |
| 14 | 731616106065 | SELLAKRISHNARAJA S | ECE | P |
| 15 | 731616106067 | SHOWMIYA M | ECE | P |
| 16 | 731616106069 | SRIMATHI G | ECE | P |
| 17 | 731616106072 | SUMATHI R | ECE | P |
| 18 | 731616106079 | THANGAVEL P | ECE | P |
| 19 | 731616205039 | SWETHA S | IT | P |
| 20 | 731616104004 | ARUN.R | CSE | P |
| 21 | 731616104016 | JAYAVARSHINI.G | CSE | P |
| 22 | 731616104031 | PUGAZHIVELAN.P | CSE | P |
| 23 | 731616104041 | SWETHA.C | CSE | P |
| 24 | 731616104045 | VENMATHI.S | CSE | P |
| 25 | 731616104048 | YUVAPRIYANKA.V | CSE | A |
| 26 | 731616104701 | S.KOMATHI | CSE | A |
| 27 | 731616104035 | SHILPA.B | CSE | A |
| Present | | | | 23 |
| Absent | | | | 4 |

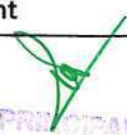
 PRINCIPAL,
 K. S. R. INSTITUTE FOR
 ENGINEERING AND TECHNOLOGY,
 K. S. R. PALATHI NAGAR,
 TIRUCHENGODE - 637 215,
 NARAYANA NADU.

**K S R INSTITUTE FOR ENGINEERING AND TECHNOLOGY
TIRUCHENGODE - 637 215**

TRAINING PROGRAMME FEEDBACK FORM



Name of the Student: R. Ann Branch: CSE

Year / Sem: IV / VII

- Name of the Training : Soft skills Training
- Name of the Trainer : A. Sangeetha, Soft Skill Trainer
- Students rating of Trainers :

| S. No. | Date | Subject | Rating (✓) | | | |
|--------|---------|----------------------|------------|-----------|------|---------|
| | | | Excellent | Very good | Good | Average |
| 1 | 17/1/20 | Soft skills Training | ✓ | | | |

- Two positive points about the programme:
* Useful session & Informative
Learned more aptitude
- Suggestions for improvement:

Date: 17/1/20 Signature: R. Ann

**K S R INSTITUTE FOR ENGINEERING AND TECHNOLOGY
TIRUCHENGODE - 637 215**

TRAINING PROGRAMME FEEDBACK FORM



Name of the Student: SWETHA.S Branch: IT

Year / Sem: IV / VII

- Name of the Training : Soft Skills Training
- Name of the Trainer : A. Sangeetha, soft skill trainer
- Students rating of Trainers :

| S. No. | Date | Subject | Rating (✓) | | | |
|--------|---------|----------------------|------------|-----------|------|---------|
| | | | Excellent | Very good | Good | Average |
| 1 | 17/1/20 | Soft skills Training | ✓ | | | |

- Two positive points about the programme:
* Informative session
- Suggestions for improvement:

Date: 17/1/20 Signature: Swetha

K S R INSTITUTE FOR
ENGINEERING AND TECHNOLOGY,
K. S. R. MAIN NAGAR,
TIRUCHENGODE - 637 215,
KAMAKKAL DI, TAMIL NADU.



Three Days Company Specific Soft Skills Training Programme

Ref: KSRIET/T&P/CIR/2019-20

Date: 18.01.2020

This is to inform that all the HoD's, Class Advisor and Training and Placement coordinators that the three days Soft skills Training programme is planned for III Year Students (2016- 2020 batch) on 21.01.2020 to 23.01.2020 at KSREI, IT Park by Ms A Sangeetha, Soft Skill Trainer, Central Placement Training Cell for the academic year 2019 - 2020 (Even Sem). All the Eligible students should attend the Training Programme without fail as per the schedule given below. Proper Dress Code is mandatory.

| S.NO | Date & Time | Eligible Students Count |
|------|--------------------------------|---|
| 1 | 21.01.2020 To 23.01.2020 | CSE - 3, ECE - 6 & IT- 3 MECH -3 Total - 15 |



T&P OFFICER

T&P COORDINATOR

PRINCIPAL

Copy to:

1. All HoDs
2. Notice Board

PRINCIPAL,
K. S. R. INSTITUTE FOR
ENGINEERING AND TECHNOLOGY,
K. S. R. IT PARK,
TIRUCHENGODE - 637 215,
NAMAKKAL Dt, TAMIL NADU.



placement KSRIET <placement@ksriet.ac.in>

Training Co-ordinators Meeting Mintues 20/01/2020

1 message

Training <training@ksrei.org> Wed, Jan 22, 2020 at 5:17 AM
 To: "singaravelg@gmail.com" <singaravelg@gmail.com>, "training@ksrct.ac.in" <training@ksrct.ac.in>, "placement@ksriet.ac.in" <placement@ksriet.ac.in>, "ksrceplacement@gmail.com" <ksrceplacement@gmail.com>, Mohankumar Ramanan <mohankumar@ksrei.org>, Nagarajan Gurusamy <nagarajan@ksrei.org>, Poornima R <poornima@ksrei.org>, "Mr. Gopal Raju" <gopalraju@ksrei.org>, Sangeetha A <sangeetha.a@ksrei.org>
 Cc: "Mr. Ganesh Kumar" <ganesh@ksrei.org>, "Mr. Srinivasan R" <vicechairman@ksrei.org>

Dear All,

Greetings

1. Review status update of January 2020 Training.

KSRCE

=====

3rd year

=====

1. Aptitude - In Progress

2. Communication - In Progress

3. Web, DS - Yet to Start

2nd year

=====

Planned for every Saturday from January 2020

KSRCT

=====

3rd Year

=====

1. Aptitude - Yet to start / Mentor with final year students
2. Communication - Yet to start
3. Gate Training in progress - CCD Hours
4. 20 Students in Full Stack Development - CSE / IT
5. 25 Students in Full Stack Development - ECE / EEE - Yet to start

<https://mail.google.com/mail/u/0?ik=d0cf9f0767&view=pt&search=all&permthid=thread-f%3A1656383542702500403&siml=msg-f%3A165638354270...> 1/4

K. S. R. INSTITUTE FOR
 ENGINEERING AND TECHNOLOGY
 K. S. R. INSTITUTE FOR
 TRAINING
 TIRUCHENAI - 627 015,
 TAMIL NADU.

2nd Year

=====

- 1. Communication - In progress in CCD Hours
- 2. Aptitude - Yet to start
- 3. Technical - Yet to start

KSRIET

=====

3rd Year

=====

- 1. Aptitude - Yet to start / Every Tuesday with help of final year students
- 2. Communication - Yet to start / Wednesday evening - GD
- 3. Technical - In progress

20 Students - Full Stack Development

2nd Year

=====

- 1. Communication - In progress
- 2. Aptitude - No Plan
- 3. Technical - Yet start

2. 21, 22 and 23 soft skill training program for third year -

(last 05, January 2020 meeting we have discussed about this. I request training coordinator give student namelist before tomorrow morning

KSRCT 20

KSRCE 15

KSRIET 15)

Venue : KSRCE - D Block, First Floor



3. KSR Ideathon total received project 86. Discussion further move

4. Discussion on Feb training - four request given by Ksriet and one request from Ksrct.

5. Discussion about pilot batch amazon wit 2021 training given.

6. Free dates in Academic Calendar for Feb 1 to March 15 for Aptitude Training for third years

7. Full Stack development training for third year students from Feb 1st to March 22nd - Training will given by Central Training Hub Team

8. Discussion for life skill training program for first year

9. FDP Program in Email Ethics for all three engineering college faculty

Thank you all

M.P.Jegadeesan

Head Training |Training Hub
KSR Educational Institutions

K.S.R Kalvi Nagar

Tiruchengode – 637215

Namakkal District | Tamil Nadu | India

www.ksrei.org

Happy Learning; Happy Teaching



PRINCIPAL,
K. S. R. INSTITUTE FOR
ENGINEERING AND TECHNOLOGY,
K. S. R. KALVI NAGAR,
TIRUCHENGODE - 637 215,
NAMANKAL DISTRICT, TAMIL NADU.



KSR
K. S. R. INSTITUTE FOR
ENGINEERING AND TECHNOLOGY

3 days soft Skills Training Programme - Students Name list

| BATCH: 2017 - 2021 | | Trainer: Ms. Sangeetha | | Sem: EVEN | | Academic Year: 2019 - 2020 | | | |
|----------------------------|--------------|------------------------|--------|------------|----|----------------------------|----|------------|----|
| Date of Training Programme | | | | 21.01.2020 | | 22.01.2020 | | 23.01.2020 | |
| S. No | Reg No | Name | Branch | FN | AN | FN | AN | FN | AN |
| 1 | 731617104005 | BABU R | CSE | / | / | / | / | A | A |
| 2 | 731617104012 | DINESHKUMAR K | CSE | / | / | / | / | / | / |
| 3 | 731617104046 | SNEHA P | CSE | / | / | / | / | / | / |
| 4 | 731617205025 | LAKSHMANAN R | IT | / | / | / | / | / | / |
| 5 | 731617205027 | MOUNISH G | IT | / | / | / | / | / | / |
| 6 | 731617205041 | SANTHOSH KUMAR R | IT | / | / | / | / | / | / |
| 7 | 731617114011 | BHAGAVATHI PERUMAL G | MECH | / | / | / | / | / | / |
| 8 | 731617114058 | MOHANARAJ C | MECH | / | / | / | / | / | / |
| 9 | 731617114107 | YASWANTHKARTHIK S | MECH | / | / | / | / | / | / |
| 10 | 731617106021 | Harikrishnan M | ECE | / | / | / | / | / | / |
| 11 | 731617106023 | Hemaharini S | ECE | / | / | / | / | / | / |
| 12 | 731617106041 | Muthulakshmi S | ECE | / | / | A | A | / | / |
| 13 | 731617106046 | Parkavi S | ECE | / | / | / | / | / | / |
| 14 | 731617106068 | Sridharan M | ECE | / | / | / | / | / | / |
| 15 | 731617106082 | Tejaswini S | ECE | / | / | / | / | / | / |

 PRINCIPAL
 K. S. R. INSTITUTE FOR
 ENGINEERING AND TECHNOLOGY
 K. S. R. ROAD,
 TIRUCHENGODE - 614 014
 KANNIYAKUMARI, TAMIL NADU.

K S R INSTITUTE FOR ENGINEERING AND TECHNOLOGY,

TIRUCHENGODE - 637 215



TRAINING AND PLACEMENT CELL

Training Schedule [2019 - 2020] Even Semester

Ref: KSRIET/T&P/CIR/2019-20

Date: 21.01.2020

This is to inform that all the HoD's, Class Advisor and Training and Placement coordinators that the one days Soft skills Training programme on "Skill for Work" is planned for III year students on 22.01.2020 at EEE Seminar hall by Dr B D Roweena, Cambridge Assessment Team .



T&P OFFICER

T&P COORDINATOR

PRINCIPAL

Copy to:

1. All HoDs
2. Notice Board

PRINCIPAL,
K. S. R. INSTITUTE FOR
ENGINEERING AND TECHNOLOGY,
K. S. R. ILAVU NAGAR,
TIRUCHENGODE - 637 215,
NARASIPALU, TAMIL NADU.

Training and Placement Cell

Skills for Works by Dr B D Roweena, Cambridge Assessment Team

BATCH : 2017 - 2021

Academic Year: 2019 - 2020

| S. No | Reg No | Name | Branch | 22.01.2020 |
|-------|--------------|----------------------|--------|------------|
| 1 | 731617104004 | ARUN KUMAR N | CSE | / |
| 2 | 731617104016 | GOWTHAM G | CSE | / |
| 3 | 731617104026 | KRISHNAMOORTHY S | CSE | / |
| 4 | 731617104028 | MARIMUTHU R | CSE | / |
| 5 | 731617104037 | PRAKASH V | CSE | / |
| 6 | 731617104039 | PRASANTH T | CSE | / |
| 7 | 731617104043 | SANTHOSHKUMAR | CSE | / |
| 8 | 731617104054 | VIGNESH S | CSE | / |
| 9 | 731617104701 | MADHAN KUMAR | CSE | / |
| 10 | 731617104702 | DEEPAK J | CSE | / |
| 11 | 731617106003 | ALKA P | ECE | / |
| 12 | 731617106008 | DARANIDARAN R S | ECE | / |
| 13 | 731617106011 | DHANUSHKODI N | ECE | / |
| 14 | 731617106019 | GOWTHAM M | ECE | / |
| 15 | 731617106020 | HARI HARA SUDHAN R | ECE | / |
| 16 | 731617106051 | RAGHURAMACHANDIRAN.V | ECE | / |
| 17 | 731617106062 | SHARUMATHI S | ECE | / |
| 18 | 731617106063 | SINDUJA K | ECE | / |
| 19 | 731617106071 | SRI RANJANI S | ECE | / |
| 20 | 731617106077 | SURYAPRIYA K | ECE | / |
| 21 | 731617106079 | SWEETLIN JOSHVA.A | ECE | / |
| 22 | 731617105005 | DINESH C | EEE | / |
| 23 | 731617105009 | GUGANESH R | EEE | / |
| 24 | 731617105016 | KAMALAHASAN G | EEE | / |
| 25 | 731617105018 | KAVINKUMAR M | EEE | / |
| 26 | 731617105034 | RAMYA A | EEE | / |
| 27 | 731617105040 | SASIKUMAR C | EEE | / |
| 28 | 731617105037 | SANTHOSHKUMAR K | EEE | / |
| 29 | 731617105044 | SHYAM PRASHAD S | EEE | / |
| 30 | 731617105049 | SURESH P | EEE | / |
| 31 | 731617105052 | THAMIZHSELVAN R | EEE | / |
| 32 | 731617205013 | HARI PRASATH K | IT | / |
| 33 | 731617205026 | MANIKANDAN A | IT | / |
| 34 | 731617205032 | NAVEENKUMAR G | IT | / |
| 35 | 731617205045 | SELVAMALAR P | IT | / |
| 36 | 731617205046 | SHAILAA P M | IT | / |
| 37 | 731617205051 | THANEESWARAN Y G | IT | / |
| 38 | 731617205053 | VENKATESWARAN S | IT | / |
| 39 | 731617114030 | GOVINDHARASU R | MECH A | / |
| 40 | 731617114033 | HARIHARAN G | MECH A | / |
| 41 | 731617114038 | JAGATHESHWARAN N | MECH A | / |
| 42 | 731617114051 | KIRUBAKARAN K | MECH A | / |
| 43 | 731617114062 | NARESH M | MECH B | / |
| 44 | 731617114077 | PREMRAJ S | MECH B | / |
| 45 | 731617114079 | RAMKUMAR B | MECH B | / |
| 46 | 731617114086 | SARAVANAA M | MECH B | / |
| 47 | 731617114093 | SURENDHAR P | MECH B | / |

**K S R INSTITUTE FOR ENGINEERING AND TECHNOLOGY
TIRUCHENGODE - 637 215**

TRAINING PROGRAMME FEEDBACK FORM



Name of the Student: Manikandan A

Branch: IT

Year / Sem: III / VI

1. Name of the Training: Soft skill training "Skill for Work"

2. Name of the Trainer: Dr. B.D. Rowena

3. Students rating of Trainers :

| S. No. | Date | Subject | Rating (√) | | | |
|--------|-----------|----------------|------------|-----------|------|---------|
| | | | Excellent | Very good | Good | Average |
| 1 | 22.1.2020 | Skill for work | ✓ | | | |

4. Two positive points about the programme:

The session was very interesting

5. Suggestions for improvement:

Date: 22.1.2020

A. Manikandan
Signature

**K S R INSTITUTE FOR ENGINEERING AND TECHNOLOGY
TIRUCHENGODE - 637 215**

TRAINING PROGRAMME FEEDBACK FORM



Name of the Student: SELVA MAJAR.P

Branch: IT

Year / Sem: III / VI

1. Name of the Training: Soft skill training "skills for work"

2. Name of the Trainer: Dr. B.D. Rowena

3. Students rating of Trainers :

| S. No. | Date | Subject | Rating (√) | | | |
|--------|-----------|----------------|------------|-----------|------|---------|
| | | | Excellent | Very good | Good | Average |
| 1 | 22.1.2020 | Skill for work | ✓ | | | |

4. Two positive points about the programme: This session was very useful

5. Suggestions for improvement:

Date: 22.1.2020

Selva
Signature



Soft Skills and Personality Development Workshop

Ref: KSRIET/T&P/CIR/2019-20

Date: 03.02.2020

This is to inform that all the HoD's, Class Advisor and Training and Placement coordinators that the two days Soft skills Training programme is planned for II year students on 05.02.2020 & 06.02.2020 at ECE Seminar hall by Ms. A. Sangeetha, Soft Skills Trainer , Central Placement Training Cell. Schedule is given below.

DAY 1 PLAN OF ACTION(05.02.2020)

| S.No | Session | Activities |
|------|------------------------|----------------------|
| 1 | Listening Skills | Jump In, Jump Out |
| 2 | Problem Solving Skills | Brain Blast |
| 3 | Team Work | Team Work Management |

DAY 2 PLAN OF ACTION(06.02.2020)

| S.No | Session | Activities |
|------|----------------------|------------------|
| 1 | Leadership Skills | Start, Stop |
| 2 | Email Etiquette | |
| 3 | Resume Writing | |
| 4 | Communication Skills | Group Discussion |

[Signature]
T&P OFFICER

[Signature]
T&P COORDINATOR

[Signature]
PRINCIPAL

Copy to:

1. All HoDs

2. Notice Board

[Green Stamp]
PRINCIPAL,
K. S. R. INSTITUTE FOR
ENGINEERING AND TECHNOLOGY,
K. S. R. INSTITUTE FOR
ENGINEERING AND TECHNOLOGY,
TIRUCHENGODE, TAMIL NADU.



KSR

K.S.R. Kalvi Nagar (Near Erode), Tiruchengode-637 215

Namakkal District, Tamil Nadu, India.



21st Development Series
Iss. No. 204

SDS-3 Soft Skills and Personality Development Workshop (KSRIET)

| S.No | Name | Department | College | Day1 | Day2 |
|------|----------------------|------------|---------|-----------|-----------|
| 1 | Alka P | ECE | KSRIET | P | P |
| 2 | Dhanushkodi N | ECE | KSRIET | P | P |
| 3 | Gokulnath N | ECE | KSRIET | P | P |
| 4 | Keerthana S | ECE | KSRIET | P | P |
| 5 | Manjula T | ECE | KSRIET | P | P |
| 6 | Parkavi S | ECE | KSRIET | P | Ab |
| 7 | Pavithra T | ECE | KSRIET | P | M-P; A-Ab |
| 8 | Raghuramachandiran V | ECE | KSRIET | P | P |
| 9 | Ramya S | ECE | KSRIET | P | P |
| 10 | Sharumathi S | ECE | KSRIET | P | P |
| 11 | Sinduja K | ECE | KSRIET | P | P |
| 12 | Sreemathi G | ECE | KSRIET | P | P |
| 13 | Suryapriya K | ECE | KSRIET | P | P |
| 14 | Daranidaran R S | ECE | KSRIET | P | P |
| 15 | Harikrishnan M | ECE | KSRIET | P | P |
| 16 | Hemaharini S | ECE | KSRIET | P | P |
| 17 | Santhiya Y | ECE | KSRIET | P | P |
| 18 | Srinivasan A | ECE | KSRIET | P | Ab |
| 19 | Yasodha P | ECE | KSRIET | M-P; A-Ab | M-P; A-Ab |
| 20 | Parkavi P | ECE | KSRIET | P | P |
| 21 | Babu U S | IT | KSRIET | P | P |
| 22 | Balamurugan S | IT | KSRIET | P | P |
| 23 | Gobika M | IT | KSRIET | P | P |
| 24 | Jessica Collins | IT | KSRIET | P | P |
| 25 | Mounish G | IT | KSRIET | P | P |
| 26 | Naveenkumar G | IT | KSRIET | P | P |
| 27 | Saran V | IT | KSRIET | P | P |
| 28 | Sreemathi Indra S | IT | KSRIET | P | P |
| 29 | Thaneeshwaran Y G | IT | KSRIET | P | P |
| 30 | Thusmeena K R | IT | KSRIET | P | P |
| 31 | Arul M | EEE | KSRIET | P | P |
| 32 | Dinesh C | EEE | KSRIET | P | P |
| 33 | Guganesh R | EEE | KSRIET | P | P |
| 34 | Kavinkumar M | EEE | KSRIET | P | P |
| 35 | Kavin Muthu Kumar S | EEE | KSRIET | P | P |
| 36 | Santhoshkumar K | EEE | KSRIET | P | P |
| 37 | Sasikumar C | EEE | KSRIET | P | P |
| 38 | Shyam Prasad S | EEE | KSRIET | P | P |
| 39 | Suresh P | EEE | KSRIET | P | P |
| 40 | Thamizhselvan R | EEE | KSRIET | P | P |
| 41 | Gokulraj B | MECH | KSRIET | P | P |
| 42 | Indirajith M | MECH | KSRIET | P | P |
| 43 | Karthikeyan T | MECH | KSRIET | P | P |
| 44 | Kavinkumar C | MECH | KSRIET | P | P |
| 45 | Manikandan R | MECH | KSRIET | P | P |
| 46 | Naresh M | MECH | KSRIET | P | P |
| 47 | Pavithran G | MECH | KSRIET | P | P |
| 48 | Prasath R | MECH | KSRIET | P | P |
| 49 | Sridhar C | MECH | KSRIET | P | P |
| 50 | Sridharan R | MECH | KSRIET | P | P |

K. S. R. Kalvi Nagar
 ENGINEERING COLLEGE FOR
 TECHNOLOGY,
 K. S. R. Kalvi Nagar,
 Tiruchengode - 637 215,
 Namakkal District, Tamil Nadu.



KSR
KSR Educational Institutions

KSR Educational Institutions

K.S.R. Kalvi Nagar (Near Erode), Tiruchengode-637 215

Namakkal District, Tamil Nadu, India.



KSR
Skill Development Series
EST. 1983

SDS-03 Soft Skills and Personality Development Workshop (KSRIET)

| S.No | Name | Branch | Feedback |
|------|----------------------|--------|---|
| 1 | Alka P | ECE | You have a very good communication skills. And there is a clarity in what you deliver. You are doing a brilliant job. Keep doing! |
| 2 | Dhanushkodi N | ECE | You are doing a good job. Engage your listeners by modulating the tone not saying by the same flat tone. |
| 3 | Gokulnath N | ECE | When you improve your communication skills, you can come across more confidently. Nothing can be done without faith and confidence. Please learn the basics of non verbal communication. |
| 4 | Keerthana S | ECE | Good communication skills are key to success. You are awesome. Keep rocking as always. |
| 5 | Manjula T | ECE | Try to be little more expressive in what you convey. If you put some more efforts, you can do a wonderful job. |
| 6 | Parkavi S | ECE | Participate more and take the ownership. You have a good content. |
| 7 | Pavithra T | ECE | Success only comes to those who are confident. I appreciate your confidence. Please improve your body language, you can one day become a good speaker too. |
| 8 | Raghuramachandiran V | ECE | Believe you can do, you will be half way there. Please be confident in whatever you deliver. You have a good subject knowledge, Unless and until you overcome your fear, you cannot express your views and thoughts to others. |
| 9 | Ramya S | ECE | You are doing a wonderful job. You have a very communication skills, and you are concise and to the point. I appreciate your work. Keep doing! |
| 10 | Sharumathi S | ECE | Analytical skills will make progress in what you do. You have a good communication skills. Try and learn to communicate more effectively and sure you can make wonders. |
| 11 | Sinduja K | ECE | Body language is very important. You are an active listener. If you put some efforts in the way to communicate, you can be a good speaker as well. |
| 12 | Sreemathi G | ECE | Engage your listeners by modulating the tone not saying by the same flat tone. Maintain proper eye contact. |
| 13 | Suryapriya K | ECE | You are doing a great job. Please take the ownership and participate more. Make use of opportunities and stand unique among everyone. |
| 14 | Daranidaran R S | FCE | Be prompt in which you reply. Take time to respond. Prepare and respond in a right way. |
| 15 | Harikrishnan M | ECE | Learn the basics of non verbal communication. Include the key points in the beginning and the end. Be clear in what you say. Believe yourself. You are capable of doing anything. Make communication a priority and please develop which you can do for sure. |

| S.No | Name | Branch | Feedback |
|------|-------------------|--------|--|
| 16 | Hemaharini S | ECE | Be little more clear in what you convey. Try to communicate effectively. |
| 17 | Santhiya Y | ECE | Make use of opportunity. Participate more and be little more expressive in your thoughts. |
| 18 | Srinivasan A | ECE | ab |
| 19 | Yasodha P | ECE | ab |
| 20 | Parkavi P | ECE | Be concise to your point. I can see a great improvement in you within this two days. Keep practising! |
| 21 | Babu U S | IT | You are really doing great. I appreciate your participation and ownership. Keep doing! |
| 22 | Balamurugan S | IT | Please do not listen to reply alone. Please listen to understand. When you listen attentively, you can speak effectively and can make wonders. |
| 23 | Gobika M | IT | I appreciate your ownership. You are an active listener. If you put some efforts in the way to communicate, you can be a good speaker as well. |
| 24 | Jessica Collins | IT | You are doing a brilliant job. I appreciate your confidence, the way you put together your ideas and the way you deliver that effectively. Keep rocking as always! |
| 25 | Mounish G | IT | Seize the moment. Please make use of all the opportunities. |
| 26 | Naveenkumar G | IT | You are so talented and you have a good subject knowledge. Life is all about having fun, its quite interesting to see a person like you carrying that smile in face all th times. I appreciate your positive attitude. But you need to be serious at times too. I hope you will take this feedback and will perform. |
| 27 | Saran V | IT | You have good subject knowledge. But delivering factor is which missing. Be confident in your self and believe that you are a Winner. Your self confidence will make you unstoppable. |
| 28 | Sreemathi Indra S | IT | You re really doing good. You are an active listener. If you listen properly, you can become a good speaker and make wonders. |
| 29 | Thaneeshwaran Y G | IT | When you improve your communication skills, you can come across more confidently. Nothing can be done without faith and confidence. |
| 30 | Thusmeena K R | IT | Be prompt in which you reply. Take time to respond. Prepare and respond in a right way. |
| 31 | Arul M | EEE | Self confidence is a super power, Once you believe yourself, you will get more successes. |
| 32 | Dinesh C | EEE | You are doing a wonderful job. I appreciate your job. Keep doing! |
| 33 | Guganesh R | EEE | Learn how to communicate effectively. If you are willing to work on it, you can rapidly improve the quality of every part of life. |

| S.No | Name | Branch | Feedback |
|------|---------------------|--------|--|
| 34 | Kavinkumar M | EEE | Believe you can and you are half way there. Try to improve your communication skills and maintain proper eye contact. Be clear in what you say. |
| 35 | Kavin Muthu Kumar S | EEE | Take advantage of every opportunity to practice your communication skills. Opportunities wont come everytime. You need to grab it and make use of it. I feel you still need to participate more. |
| 36 | Santhoshkumar K | EEE | Please practice on the basics of the non verbal communication..Body language is very important. |
| 37 | Sasikumar C | EEE | Believe yourself that you are capable of everything and don't hesitate to share your views. |
| 38 | Shyam Prasad S | EEE | You are very talented. If you put some efforts, you can shine better. |
| 39 | Suresh P | EEE | Make sure you understood before you communicate. Body language is very important. Please maintain proper eye contact. Try to complete the sentence. |
| 40 | Thamizhselvan R | EEE | I appreciate your participation and creative thinking skills. Keep rocking! |
| 41 | Gokulraj B | MECH | Seize the moment. Because some oppurtunities wont come twice. Please make use of all the oppurtunities and practice on your communication skills. |
| 42 | Indirajith M | MECH | Please believe yourself that you are capable of everything and don't hesitate to share your views. When you improve your communication skills, you can come across more confidently. |
| 43 | Karthikeyan T | MECH | Success is where prepartaion and opportunity meet. Please learn how to communicate effectively. You are very talented. I am expecting more participation from you. |
| 44 | Kavinkumar C | MECH | Please learn the basics of non verbal communication and communication skills. |
| 45 | Manikandan R | MECH | You have good communication skills, learn how to communicate more effectively |
| 46 | Naresh M | MECH | Body language is very important. You are an active listener. If you put some efforts in the way to communicate, you can be a good speaker as well. |
| 47 | Pavithran G | MECH | Bc concise to your point. You have that ability to do. Please practice on the basics of the non verbal communication |
| 48 | Prasath R | MECH | I can see great improvement within you in these two days. Keep practicing. You can make wonders. |
| 49 | Sridhar C | MECH | You have good subject knowledge. I can see great improvement within you in these two days. Keep practicing. |
| 50 | Sridharan R | MECH | Analytical skills will make progress in what you do. Please practice on how to communicate effectively. |

PRINCIPAL,
K. S. P. INSTITUTE FOR
ENGINEERING AND TECHNOLOGY,
K. S. P. ENGINEERING COLLEGE,
TIRUPATI

**K S R INSTITUTE FOR ENGINEERING AND TECHNOLOGY
TIRUCHENGODE - 637 215**

TRAINING PROGRAMME FEEDBACK FORM



Name of the Student: ALKA P Branch: ECE

Year / Sem: II / IV

1. Name of the Training : Soft skills & Personality Development Workshop

2. Name of the Trainer : Ms. A. Sangeetha

3. Students rating of Trainers :

| S. No. | Date | Subject | Rating (✓) | | | |
|--------|-----------|-----------------------------|------------|-----------|------|---------|
| | | | Excellent | Very good | Good | Average |
| 1 | 03-2-2020 | Soft skill training program | ✓ | | | |

4. Two positive points about the programme:

The session is good

5. Suggestions for improvement:

Date: 3-2-20

Alka P
Signature

**K S R INSTITUTE FOR ENGINEERING AND TECHNOLOGY
TIRUCHENGODE - 637 215**

TRAINING PROGRAMME FEEDBACK FORM



Name of the Student: Jessica Collins Branch: BT

Year / Sem: III / VI

1. Name of the Training : Soft Skills & Personality Development workshop

2. Name of the Trainer : Ms. A. Sangeetha

3. Students rating of Trainers :

| S. No. | Date | Subject | Rating (✓) | | | |
|--------|-----------|-----------------------------|------------|-----------|------|---------|
| | | | Excellent | Very good | Good | Average |
| 1 | 03/2/2020 | Soft skill training program | | | | |

4. Two positive points about the programme:

The session was interesting

5. Suggestions for improvement:

Date: 3/2/20

Jessica
Signature

2. LANGUAGE AND COMMUNICATION SKILLS

K S R INSTITUTE FOR ENGINEERING AND TECHNOLOGY

LANGUAGE AND COMMUNICATION SKILLS CONSOLIDATED LIST

Academic Year:2019-2020

| S.NO. | Name of the capability enhancement program | Date of implementation (DD-MM-YYYY) | Number of students enrolled | Name of the agencies/consultants involved with contact details (if any) |
|--------------|---|--|------------------------------------|--|
| 1 | Essay writing | 26.09.2019 | 42 | KSRIET-Linga Club, hod_english@ksriet.ac.in |
| 2 | Slogan writing | 25.01.2020 | 47 | KSRIET-Linga Club, hod_english@ksriet.ac.in |
| 3 | Poem composing | 25.01.2020 | 53 | KSRIET-Linga Club, hod_english@ksriet.ac.in |
| 4 | JAM (just a minute talk) | 22.02.2020 | 27 | KSRIET-Linga Club, hod_english@ksriet.ac.in |
| 5 | Tongue twisters | 22.02.2020 | 56 | KSRIET-Linga Club, hod_english@ksriet.ac.in |
| 6 | Spell bee | 22.02.2020 | 29 | KSRIET-Linga Club, hod_english@ksriet.ac.in |

PRINCIPAL

**K. S. R. KALVI NAGAR,
TIRUCHENGODE - 637 215,
NAMAKKAL DS, TAMIL NADU.**

K S R INSTITUTE FOR ENGINEERING AND TECHNOLOGY
TIRUCHENGODE - 637 215



REF: KSRIET/ENG/CIR/2019-2020/004

DATE: 24.09.2019

CIRCULAR

This is to inform all the students that **Lingua Club** (*A Lantern to Quest...*) has planned to conduct Essay Writing competition on 26th September 2019. Interested students can enroll their names with Mr. S. Madhan, Assistant Professor of English on or before 25.09.2019. The details of the competition are as follows.

Topic: **Plastics - Effects and Affects**

Duration: **30 Minutes**

Venue: **Language Lab**

Date: **26.09.2019**

Time: **03:30 p.m.**

25/9/19.

Dr. C. Muguntharajan
Convenor - Lingua Club

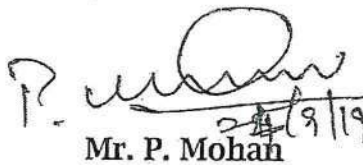
24/9/19

Mr. P. Mohan
Organiser - Lingua Club

25/9/19

PRINCIPAL

Circulated to:

1. HoDs - All Departments
2. College Notice Board
3. All I, II, III and IV Year Classes

PRINCIPAL,
K. S. R. INSTITUTE FOR
ENGINEERING AND TECHNOLOGY,
K. S. R. KALVI NAGAR,
TIRUCHENGODE - 637 215,
NAMAKKAL Dt, TAMIL NADU.

K S R INSTITUTE FOR ENGINEERING AND TECHNOLOGY

DEPARTMENT OF ENGLISH

LINGUA CLUB

ESSAY WRITING

REGISTRATION FORM

Date: 26.09.2019



| S. No | Name | Class | Signature |
|-------|--------------------|-------|--------------------|
| 1 | V. Thulasivasan | IT | V. Thulasivasan |
| 2 | A. MUTHREYAN | IT | A. Muthreyan |
| 3 | R. Sandhya | Mech | R. Sandhya |
| 4 | R. Dharshini | IT | R. Dharshini |
| 5 | T. Deepika | IT | T. Deepika |
| 6 | R. Pavithra | IT | R. Pavithra |
| 7 | J. Rasiga | IT | J. Rasiga |
| 8 | A. VIJAYARAGAVAN | IT | A. Vijayaragavan |
| 9 | T. Veerasakthivel | IT | T. Veerasakthivel |
| 10 | Sp. Valliappan | Mech | Sp. Valliappan |
| (11) | G. S. Mukesh Kumar | Mech | G. S. Mukesh Kumar |
| 12 | S. Sakthivel | ECE | S. Sakthivel |
| 13 | P. Ram mangan | EEE | P. Ram mangan |
| 14 | J. Karthick | IT | J. Karthick |
| 15 | P. Vignesh | Mech | P. Vignesh |
| 16 | G. G. Rakesh | Mech | G. G. Rakesh |
| 17 | S. Naveen | EEE | S. Naveen |
| 18 | P. Ragul | EEE | P. Ragul |
| 19 | P. Jogeshwaran. | EEE | P. Jogeshwaran. |
| 20 | M. Vikraman | EEE | M. Vikraman |
| 21 | K. Rajesh Kannan | IT | K. Rajesh Kannan |
| 22 | A. Dhruv | CSE | A. Dhruv |
| (23) | V. Koushik | ECE | V. Koushik |
| 24 | V. Ravi Raagul. | ECE | V. Ravi Raagul. |
| 25 | K. Raja Raman | ECE | K. Raja Raman |

PRINCIPAL,
K. S. R. INSTITUTE FOR
ENGINEERING AND TECHNOLOGY,
K. S. R. KALVI NAGAR,
TIRUCHENGODE - 637 215,
NAMAKKAL DISTRICT, TAMIL NADU.

| | | | |
|----|-------------------------|------|---|
| 26 | Hari Prasad . S | ECE | S. Jij |
| 27 | V. Ilakiya | CSE | Shaky. V. |
| 28 | B. Monikasri | CSE | M. M. M. |
| 29 | Shalene . V | CSE | Shalene . V. |
| 30 | R. Nandhini | CSE | R. Nandhini |
| 31 | Indhija . V | CSE | V. Anuja. |
| 32 | Monikasri . B | CSE | B. Monikasri |
| 33 | Madhumitha . M. | CSE. | M. Madhumitha |
| 34 | Madhumitha . B | CSE | B. Madhu |
| 35 | Jeeva . M | CSE | M. Jeeva. |
| 36 | Pavithra . K. | CSE | K. Pavithra |
| 37 | Umabharathi . C | ECE | Umabharathi . C |
| 38 | Selva Brindhak | ECE | K. Brindhak |
| 39 | Pavithri . V | CSE | V. Pavithri |
| 40 | A. Amitheswari | CSE | Amitheswari |
| 41 | J. Rasiga | IT | J. Rasiga. |
| 42 | R. Pavithra | IT | Pavithra |
| 43 | | | |
| 44 | P. Anand | | |
| 45 | organiser - Lingua club | | |
| 46 | | | |
| 47 | | | |
| 48 | e. m. s. 22/02/2020 | | |
| 49 | Convener - Lingua club | | |
| 50 | | | PRINCIPAL, K. S. R. INSTITUTE FOR ENGINEERING AND TEC K. S. R. KALVINGODI TIRUCHENGODE - 63 TAMIL NADU |
| 51 | | | |
| 52 | | | |
| 53 | | | |
| 54 | | | |
| 55 | | | |
| 56 | | | |
| 57 | | | |
| 58 | | | |
| 59 | | | |

K S R INSTITUTE FOR ENGINEERING AND TECHNOLOGY
TIRUCHENGODE - 637 215



REF: KSRIET/ENG/CIR/2019-2020/07

DATE: 23.01.2020

CIRCULAR

This is to inform all the students that **Lingua Club (A Lantern to Quest...)** has planned to conduct Slogan Writing and Poem Composing competitions on 25th January 2020. Interested students can enroll their names with Mr. S. Madhan, Assistant Professor of English on or before 25.01.2020. The details of the competitions are as follows.

Topic: On the Spot

Duration: 30 Minutes for each competition

Venue: Language Lab

Date: 25.01.2020

Time: 01:30 p.m.



Dr. C. Mughatharajan
Convenor - Lingua Club

23/01/2020
Mr. P. Mohan
Organiser - Lingua Club

PRINCIPAL

Circulated to:

1. HoDs - All Departments
2. College Notice Board
3. All I, II, III and IV Year Classes

PRINCIPAL,
K. S. R. INSTITUTE FOR
ENGINEERING AND TECHNOLOGY,
K. S. R. KALVI NAGAR,
TIRUCHENGODE - 637 215,
NAMAKKAL Dt, TAMIL NADU.

K S R INSTITUTE FOR ENGINEERING AND TECHNOLOGY

DEPARTMENT OF ENGLISH

LINGUA CLUB

SLOGAN WRITING

REGISTRATION FORM

Date: 25.01.2020



| S. No | Name | Class | Signature |
|-------|------------------------|---------------------------|---------------|
| 1 | Divyashruthi . S | IT- 1 st year | [Signature] |
| 2 | Anuritha . T | 1 st year-EEE | [Signature] |
| 3 | Swathi . R | 1 st year-EEE | R. Swathi |
| 4 | Narmatha Subhashri . S | 1 st year -ECE | S. Nady |
| 5 | NITHIVASRI . B | 1 st year-ECE | [Signature] |
| 6 | ANANTHI . S | 1 st year ECE | S Ananthi |
| 7 | Ravithra s | I ECE | S. Pavithra, |
| 8 | Umbharathi . C | I ECE | Umathy . c |
| 9 | K. Selva Brindha | I ECE | [Signature] |
| 10 | S. K. R. R. R. | I ECE | S. R. R. |
| 11 | S. Sanyanya | I ECE | [Signature] |
| 12 | K. Divyapriya | III -ECE | [Signature] |
| 13 | S. Ramya | III -ECE | [Signature] |
| 14 | P. Ranjith Kumar | I -ECE | [Signature] |
| (15) | B. S. Ranjith | I -IT | [Signature] |
| 16 | [Signature] | I -IT | [Signature] |
| 17 | R. Babu Teja Surya | I -IT | [Signature] |
| 18 | D. Vigneshwaran | I -IT | [Signature] |
| 19 | S. Dilipkumar | I -IT | [Signature] |
| 20 | V. Kumar | I -EEE | V. Kumar. |
| 21 | L. NANDHA KUMAR | I -EEE | [Signature] |
| 22 | P. RAGUL | I -EEE | P. Ragul |
| 23 | J. DAVIN RITHIK | II -ECE | [Signature] |
| 24 | D. Nani Anshoo | II -ECE | [Signature] |
| 25 | M. Mahamaprasathi | I -CSE | M. Mahesh |
| 26 | P. Abhinathan | I -CSE | [Signature] |
| 27 | M. Ganesh | I -CSE | [Signature] |
| 28 | B. GOBI | I -CSE | B. Gobi |
| 29 | A. Dhevak | I -CSE | [Signature] |
| 30 | S. Prasanth | I -CSE | [Signature] |
| 31 | P. Premkumar | I -CSE | P. Premkumar. |
| 32 | M. Manojkumar | I -CSE | M. Manojkumar |
| 33 | m. yagesh | I -CSE | [Signature] |
| 34 | A. SATHEESH NATRAYAN | I -CSE | A. Satheesh |
| 35 | R. Sai Siva Saijay | I -CSE | [Signature] |
| 36 | R. Nishanthi | I -CSE | [Signature] |

PRINCIPAL,
K. S. R. INSTITUTE FOR
ENGINEERING AND TECHNOLOGY,
K. S. R. KALVI NAGAR,
TIRUCHENGODE - 637 215,
NAMAKKAL DISTRICT, TAMIL NADU.

| | | | |
|----|--|----------|------------------|
| 37 | M. shahoon | I - CSE | M. shahoon |
| 38 | Shalene .V I | T - CSE | Shalene .V. |
| 39 | Dhansha .K II | T - CSE | Dhansha .K. |
| 40 | Monika.Sai. B | T - CSE | B Monika Sai |
| 41 | Indhija .V | T - CSE | V. Indhija. |
| 42 | Mounika.Sai. B. | T - CSE | B. Mounika Sai |
| 43 | I lakshya .V | T - CSE | V. I Lakshya. |
| 44 | Preethi .V | T - CSE | V. Preethi. |
| 45 | Amitheswari .A | T - CSE | A. Amitheswari. |
| 46 | Mukesh Kumar .K. | T - MECH | K. Mukesh Kumar. |
| 47 | Arul Murugan .S | T - CSE | S. Arul Murugan. |
| 48 | | | |
| 49 | | | |
| 50 | P. Anand | | |
| 51 | 25/11/2020 Organiser - Language Club. | | |
| 52 | | | |
| 53 | | | |
| 54 | | | |
| 55 | | | |
| 56 | 25/11/2020 | | |
| 57 | Convener - Language Club. | | |
| 58 | | | |
| 59 | | | |
| 60 | | | |
| 61 | | | |
| 62 | | | |
| 63 | | | |
| 64 | | | |
| 65 | | | |
| 66 | | | |
| 67 | | | |
| 68 | | | |
| 69 | | | |
| 70 | | | |
| 71 | | | |
| 72 | | | |
| 73 | | | |
| 74 | | | |
| 75 | | | |
| 76 | | | |
| 77 | | | |
| 78 | | | |
| 79 | | | |
| 80 | | | |
| 81 | | | |
| 82 | | | |
| 83 | | | |

PRINCIPAL,
K. S. R. INSTITUTE FOR
ENGINEERING AND TECHNOLOGY,
K. S. R. KALVI NAGAR,
TIRUCHENGODE - 637 215,
NAMAKKAL DISTRICT, TAMIL NADU.

K S R INSTITUTE FOR ENGINEERING AND TECHNOLOGY

DEPARTMENT OF ENGLISH

LINGUA CLUB

POEM COMPOSING



REGISTRATION FORM

Date: 25.01.2020

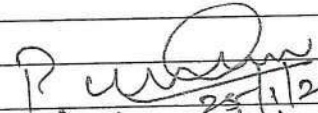

| S.No | Name | Class | Signature |
|------|------------------------|---------|--------------------|
| 1 | P. Ranjith Kumar | KCE | P. Ranjith Kumar |
| 2 | P. Jyothsna | EEE | P. Jyothsna |
| 3 | N. Ranjith Kumar | EEE | N. Ranjith Kumar |
| 4 | S. P. Karthikeyan | EEE | S. P. Karthikeyan |
| 5 | V. B. Mubashir Kumar I | I-MECH | V. B. Mubashir |
| 6 | S. Ramya III | ECE III | S. Ramya |
| 7 | K. Sudhakar | ECE III | K. Sudhakar |
| 8 | B. A. Rajith | IT I | B. A. Rajith |
| 9 | S. Arul Mangan | I-CSE | S. Arul Mangan |
| 10 | S. Divyashruthi | I-IT | S. Divyashruthi |
| 11 | P. Ranjith Kumar | P-EEE | P. Ranjith Kumar |
| 12 | R. Teja Surya | T-IT | R. Teja Surya |
| 13 | S. Prithvika | I-IT | S. Prithvika |
| 14 | L. NANDHA KUMAR | T-EEE | L. NANDHA KUMAR |
| 15 | V. Kumar | T-EEE | V. Kumar |
| 16 | M. Ganesh II | T-CSE | M. Ganesh |
| 17 | R. Ananthan | ICSE | R. Ananthan |
| 18 | M. Mohanaprasath | I-CSE | M. Mohanaprasath |
| 19 | B. Gobi | I-CSE | B. Gobi |
| 20 | A. Dhaval | T-CSE | A. Dhaval |
| 21 | D. Vigneshwaran | I-IT | D. Vigneshwaran |
| 22 | S. Pranjith | T-CSE | S. Pranjith |
| 23 | S. Karthik | I-IT | S. Karthik |
| 24 | P. Prem Kumaran | T-CSE | P. Prem Kumaran |
| 25 | M. Manoj Kumar | T-CSE | M. Manoj Kumar |
| 26 | M. Yogesh | T-CSE | M. Yogesh |
| 27 | A. SATHISH NATHAN | T-CSE | A. SATHISH NATHAN |
| 28 | R. Sai Siva Sanjay | T-CSE | R. Sai Siva Sanjay |
| 29 | M. Shaheen | I-CSE | M. Shaheen |
| 30 | K. Nishanth | I-CSE | K. Nishanth |
| 31 | T. DAVIN KITHIR | ECE | T. DAVIN KITHIR |
| 32 | D. Harikrishnan III | II ECE | D. Harikrishnan |
| 33 | Shalini V | I-CSE | Shalini V |
| 34 | Dharsana K | I-CSE | Dharsana K |
| 35 | V. Indhuja | I-CSE | V. Indhuja |
| 36 | B. Monika Sani | I-CSE | B. Monika Sani |

ENGINEERING AND TECHNOLOGY,
K. S. R. KALAI NAGAR,
TIRUCHENGODE - 637 815,
NAMAKKAL DISTRICT, TAMIL NADU.

| | | | |
|----|---|--------|-----------------|
| 37 | V. JIakiya | I-CSE | V. JIakiya |
| 38 | B. Mounikasri | I-CSE | B. Mounikasri |
| 39 | V. Preethi | I-CSE | v. Preethi |
| 40 | A. Anithemari | I-CSE | Anithemari |
| 41 | S. Sathya | I-ECE | S. Sathya |
| 42 | S. Kirthika | I-ECE | S. Kirthika |
| 43 | C. Umabharathi | I-ECE | Umabharathi.C |
| 44 | J. Selva. Bindha | I-ECE | J. Bindha |
| 45 | S. ANANTHI | I-ECE | S. Ananthi |
| 46 | S. PAVITHRA | I-ECE | S. Pavithra |
| 47 | S. NARMATHA SUDHANSHU | I-ECE | S. Nandf. |
| 48 | B. NITHIASRI | I-ECE | B. Nithisi |
| 49 | R. SWATHI | I-ECE | R. Swathi |
| 50 | J. Anunitha | I-ECE | J. Anunitha |
| 51 | P. Ragul | I-ECE | P. Ragul |
| 52 | Sundarya. G. G | II CSE | Sundarya. G. G. |
| 53 | Sushma. R | II CSE | Sushma. R |
| 54 | | | |
| 55 | | | |
| 56 | P.  25/1/2020 | | |
| 57 | organiser - Lingua club. | | |
| 58 | | | |
| 59 | | | |
| 60 | | | |
| 61 | | | |
| 62 | C.  25/1/2020 | | |
| 63 | Convener - Lingua club. | | |
| 64 | | | |
| 65 | | | |
| 66 | | | |
| 67 | | | |
| 68 | | | |
| 69 | | | |
| 70 | | | |
| 71 | | | |
| 72 | | | |
| 73 | | | |
| 74 | | | |
| 75 | | | |
| 76 | | | |
| 77 | | | |
| 78 | | | |
| 79 | | | |
| 80 | | | |
| 81 | | | |
| 82 | | | |
| 83 | | | |

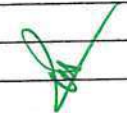
PRINCIPAL,
K. S. R. INSTITUTE FOR
ENGINEERING AND TECHNOLOGY,
K. S. R. KALYANAGAR,
TIRUCHENGODE - 637 215,
NAMAKKAL DL, TAMIL NADU.

K S R INSTITUTE FOR ENGINEERING AND TECHNOLOGY

TIRUCHENGODE - 637 215



REF: KSRIET/ENG/CIR/2019-2020/08

DATE: 17.02.2020

CIRCULAR

This is to inform all the students that **Lingua Club (A Lantern to Quest...)** has planned to conduct JAM, Tongue Twister and Spell Bee competitions on 22nd February 2020. Interested students can enroll their names with Mr. S. Madhan , Assistant Professor of English on or before 21.02.2020. The details of the competitions are as follows.

Venue: Language Lab

Date: 22.02.2020

Time: 01:30 p.m.

17/2/2020
Mr. P. Mohan
Organiser - Lingua Club

17/02/2020
Dr. C. Muhuntarajan
Convenor - Lingua Club

Principal

Circulated to:

1. HoDs - All Departments
2. College Notice Board
3. All I, II, III and IV Year Classes

PRINCIPAL,
K. S. R. INSTITUTE FOR
ENGINEERING AND TECHNOLOGY,
K. S. R. KALVI NAGAR,
TIRUCHENGODE - 637 215,
NAMAKKAL Dt, TAMIL NADU.

K S R INSTITUTE FOR ENGINEERING AND TECHNOLOGY

DEPARTMENT OF ENGLISH

LINGUA CLUB

JUST A MINUTE (JAM)

REGISTRATION FORM

Date: 22.02.2020



| S. No | Name | Class | Signature |
|-------|----------------------|---------|-------------------|
| 1 | C. Umabharathi | ECE | Umabharathi.c |
| 2 | R. Pavithra | I.T | Pavithra |
| 3 | J. Rasiga | IT | J. Rasiga |
| 4 | K. Geetha Lakshmi | CSE | K. Geetha Lakshmi |
| 5 | T. Deepika | IT | T. Deepika |
| 6 | A. Amirtheswari | CSE | A. Amirtheswari |
| 7 | Shalene V | CSE | shalene.v |
| 8 | Madhumitha. M. | CSE. | M. Madhumitha |
| 9 | S. MUTHUREVANI | IT | S. Muthurevani |
| 10 | R. Rajesh Ramma | I.T | R. Rajesh |
| 11 | V. Ravi Raagul | ECE | Ravi Raagul V. |
| 12 | M. Vikraman | FEE | Vikraman |
| 13 | K. Raja Ramani | ECE | K. Raja Ramani |
| 14 | S. Sakthivel | ECE | S. Sakthivel |
| 15 | A. Dhruv | CSE | A. Dhruv |
| 16 | A. SATHEESH NATRAYAN | CSE | A. Satheesh |
| 17 | R. Sri Ram Sanjay | CSE-IIT | R. Sri Ram Sanjay |
| 18 | G. S. Mukesh Kumar | I-Mech | G. S. Mukesh |
| 19 | R. Abinavthan | I-CSE | R. Abinav |
| 20 | P. Ranjitha Kumar | E-ECE | P. Ranjitha |
| 21 | Sonika. k.M. | I-ECE | Sonika. k.M. |
| 22 | Nandhini. M | I-FEE | Nandhini. M |
| 23 | S. Karthika | I-CSE | S. Karthika |
| 24 | M. Manojkumar | I-CSE | M. Manojkumar |
| 25 | M. Keerthirajan | I-CSE | M. Keerthirajan |

K. S. R. INSTITUTE FOR
ENGINEERING AND TECHNOLOGY,
K. S. R. KALAI NAGAR,
TIRUCHENGODE - 637 215,
NAMAKKAL DISTRICT, TAMIL NADU.

| | | | |
|----|----------------------------|------------|-----------|
| 26 | M-Ganesh | CSE | H. Ganesh |
| 27 | Mohammed Rizwan.M. | CSE | Rizwan.M. |
| 28 | | | |
| 29 | | | |
| 30 | | | |
| 31 | P. Anand | | |
| 32 | Organiser - Language Club. | | |
| 33 | | | |
| 34 | C. M. K. | 22/02/2020 | |
| 35 | Convener - Language Club. | | |
| 36 | | | |
| 37 | | | |
| 38 | | | |
| 39 | | | |
| 40 | | | |
| 41 | | | |
| 42 | | | |
| 43 | | | |
| 44 | | | |
| 45 | | | |
| 46 | | | |
| 47 | | | |
| 48 | | | |
| 49 | | | |
| 50 | | | |
| 51 | | | |
| 52 | | | |
| 53 | | | |
| 54 | | | |
| 55 | | | |
| 56 | | | |
| 57 | | | |
| 58 | | | |
| 59 | | | |

 PRINCIPAL,
 K. S. R. INSTITUTE FOR
 ENGINEERING AND TECHNOLOGY,
 K. S. R. KALAIKOTTAI,
 TIRUCHENGODE - 637 215,
 NAMAKKAL DISTRICT, TAMIL NADU.

K S R INSTITUTE FOR ENGINEERING AND TECHNOLOGY

DEPARTMENT OF ENGLISH

LINGUA CLUB

TONGUE TWISTER

REGISTRATION FORM

Date: 22.02.2020



| S. No | Name | Class | Signature |
|-------|--------------------|-------|--------------------|
| 1 | R. Shanthini | IT | R. Shanthini |
| 2 | K. SELVA BRINDHA | ECE | K. Selva |
| 3 | V. Poothi | CSE | V. Poothi |
| 4 | P. Subhashini | CSE | P. Subhashini |
| 5 | P. Nandhini | CSE | P. Nandhini |
| 6 | T. Veerasakthivel | IT | T. Veerasakthivel |
| 7 | V. Thulasivaran | IT | V. Thulasivaran |
| 8 | Sp. Valliappan | Mech | Sp. Valliappan |
| 9 | G. S. Mukesh Kumar | Mech | G. S. Mukesh Kumar |
| 10 | P. Rajul | EEE | P. Rajul |
| 11 | R. Ram murugan | EEE | R. Ram murugan |
| 12 | G. G. Rakesh | MECH | G. G. Rakesh |
| 13 | S. Hari prasad | ECE | S. Hari prasad |
| 14 | V. Koushik | ECE | V. Koushik |
| 15 | J. Karthick | IT | J. Karthick |
| 16 | P. Vignesh | Mech | P. Vignesh |
| 17 | A. VIJAYARAGAVAN | IT | A. Vijayaragavan |
| 18 | R. Abinathan | CSE | R. Abinathan |
| 19 | S. Arul Murugan | CSE | S. Arul Murugan |
| 20 | Arjun prakash .c | CSE | Arjun prakash .c |
| 21 | Porathap. D | CSE | Porathap. D |
| 22 | Manoj . J | CSE | Manoj . J |
| 23 | K. PREDM Kumar | CSE | K. PREDM Kumar |
| 24 | V. Mirun kanhan | CSE | V. Mirun kanhan |
| 25 | Mohammed Rizwan.M | CSE | Mohammed Rizwan.M |

K. S. R. INSTITUTE FOR
ENGINEERING AND TECHNOLOGY,
K. S. R. KALVI NAGAR,
TIRUCHENGODE - 637 215,
NAMAKKAL DE TAMIL NADU.

| | | | |
|----|-------------------------|----------|-------------------------|
| 26 | M. Manojkumar | CSE | M. M. [Signature] |
| 27 | P. Premkumaran | CSE | P. Premkumaran |
| 28 | Umesh | CSE | [Signature] |
| 29 | Keerthirajan | CSE | [Signature] |
| 30 | Yunus | CSE | [Signature] |
| 31 | Santhosh | CSE | [Signature] |
| 32 | Sanjay .M | CSE | [Signature] |
| 33 | B. Ananthi | ECE | Anthi .s |
| 34 | C. Umabharathi | ECE | C. Umthi .c |
| 35 | S. Prathiba | ECE | Prithi .s |
| 36 | Sonika. K.M. | ECE | [Signature] k.M. |
| 37 | Pavithra. S | ECE | S. Pavithra |
| 38 | Sumathi. R. | ECE | R. Sumathi |
| 39 | N. Dhannishya | CSE - II | N. Dhannishya |
| 40 | S. Kaviya | CSE - II | S. Kaviya |
| 41 | R. Ishwarya | CSE - II | R. Ishwarya |
| 42 | R. Jushma | CSE - II | R. Jushma |
| 43 | S. Kiruthika | CSE - II | S. Kiruthika |
| 44 | M. Kavya Princyabhasini | CSE - II | M. Kavya Princyabhasini |
| 45 | T. Deepika | IT - I | T. Deepika |
| 46 | R. Pavithra | IT - I | R. Pavithra |
| 47 | J. Rasiga | IT - I | J. Rasiga |
| 48 | S. Bhavya | ECE - I | S. Bhavya |
| 49 | V. Raja Kumar | ECE - I | V. Raja Kumar |
| 50 | Sakthivel . S | ECE - I | S. Sakthivel |
| 51 | S. MYTHREVAN | IT | S. Mythrevan |
| 52 | N. Rensithkumar | EEE - I | N. Rensithkumar |
| 53 | R. Swathi | EEE - I | R. Swathi |
| 54 | P. Vaishnavi | EEE - I | P. Vaishnavi |
| 55 | M. Praveena | EEE - I | M. Praveena |
| 56 | B. Swetha | EEE - I | B. Swetha |
| 57 | | | |
| 58 | | | |
| 59 | | | |

PRINCIPAL,
K. S. R. INSTITUTE FOR
ENGINEERING AND TECHNOLOGY,
K. S. R. KALVI NAGAR,
TIRUCHENKURU DISTRICT,
NAMAKKAL DI, TAMIL NADU

[Signature]
22/2/2020
organiser - language

Convenor - [Signature]
club

K S R INSTITUTE FOR ENGINEERING AND TECHNOLOGY

DEPARTMENT OF ENGLISH

LINGUA CLUB

SPELL BEE

REGISTRATION FORM

Date: 22.02.2020



| S. No | Name | Class | Signature |
|-------|--------------------------|--------------------------|--------------------------|
| 1 | Rengenaathan. S | ECE 1 st year | Rengenth |
| 2 | Praveen Kumar. S | ECE 1 st year | S. Praveen Kumar |
| 3 | Balabani Venishna. V | ECE 1 st year | Balabani |
| 4 | Manikandan. P | ECE 1 st year | Manikandan |
| 5 | R. Balaji | ECE 1 st year | R. Balaji |
| 6 | M. Santhosh | CSE 1 st year | M. Santhosh |
| 7 | Sanjay. N | CSE 1 st year | Sanjay |
| 8 | M. Keerthirajan | CSE 1 st year | M. Keerthirajan |
| 9 | A. Yuvaraj | CSE I-year | A. Yuvaraj |
| 10 | S. Arul Murugan | CSE I-year | S. Arul Murugan |
| 11 | Mohammed Rawan. M | CSE - I-year | Mohammed Rawan |
| 12 | V. Mirun Kannan | CSE - I-year | V. Mirun Kannan |
| 13 | P. Premkumar | CSE 1 st year | P. Premkumar |
| 14 | J. Manoj | CSE 1 st year | J. Manoj |
| 15 | R. Abhinathan | CSE 1 st year | R. Abhinathan |
| 16 | R. Sai Siva Sanjay | CSE 1 st year | R. Sai Siva Sanjay |
| 17 | K. Prem Kumar | CSE - 1 st | K. Prem Kumar |
| 18 | K. Bhanath Kumar | CSE - 1 st | K. Bhanath Kumar |
| 19 | M. Krishna moorthy | CSE - 1 st | M. Krishna moorthy |
| 20 | M. Manojkumar | CSE - 1 st | M. Manojkumar |
| 21 | Pratha P. D | CSE - 1 st | Pratha P. D |
| 22 | Ganesh. M | CSE - 1 st | Ganesh. M |
| 23 | Anun prakasb. C | CSE - 1 st | Anun prakasb. C |
| 24 | R. Ishwarya | CSE - 1 st | R. Ishwarya |
| 25 | M. Kaniya Priyadharshini | CSE - II yr | M. Kaniya Priyadharshini |

K. S. R. INSTITUTE FOR
ENGINEERING AND TECHNOLOGY,
K. S. R. KALVI NAGAR,
TIRUCHENGODE - 637 215,
NAMAKKAL Dt, TAMIL NADU.

K S R INSTITUTE FOR ENGINEERING AND TECHNOLOGY

DEPARTMENT OF ENGLISH

LINGUA CLUB

SPELL BEE

REGISTRATION FORM

Date: 22.02.2020



| S. No | Name | Class | Signature |
|-------|-------------------------------------|-------------|--------------|
| 26 | S. Kaviya | II - yr cse | S. Kaviya |
| 27 | S. Kiruthika | II - yr cse | S. Kiruthika |
| 28 | R. SUSHMA | II - yr cse | R. Sushma |
| 29 | V. DHANUSHYA | II - yr cse | V. Dhanya |
| 5 | | | |
| 6 | | | |
| 7 | <i>P. [Signature]</i> | | |
| 8 | organiser - Lingua club | | |
| 9 | | | |
| 10 | | | |
| 11 | <i>C. [Signature]</i> 22/02/2020 | | |
| 12 | Convenor - Lingua club | | |
| 13 | | | |
| 14 | | | |
| 15 | | | |
| 16 | | | |
| 17 | | | |
| 18 | | | |
| 19 | | | |
| 20 | | | |
| 21 | | | |
| 22 | | | |
| 23 | | | |
| 24 | | | |
| 25 | | | |

PRINCIPAL,
 K. S. R. INSTITUTE FOR
 ENGINEERING AND TECHNOLOGY,
 K. S. R. KALYANAGAR,
 TIRUCHENGODE - 637 215,
 NAMAKKAL DISTRICT, TAMIL NADU.

3. LIFE SKILLS

(Yoga, physical fitness, health and hygiene)

K S R INSTITUTE FOR ENGINEERING AND TECHNOLOGY

**LIFE SKILLS (YOGA, PHYSICAL FITNESS, HEALTH AND HYGIENE)
CONSOLIDATED LIST**

Academic Year:2019-2020

| S.NO. | Name of the capability enhancement program | Date of implementation (DD-MM-YYYY) | Number of students enrolled | Name of the agencies/consultants involved with contact details (if any) |
|--------------|---|--|------------------------------------|--|
| 1 | Blood Donation Camp | 19.07.2019 | 72 | KSRIET-NSS,nssksriet@gmail.com |
| 2 | HIV Awareness Program | 02.12.2019 | 124 | KSRIET-NSS,nssksriet@gmail.com |
| 3 | An Awareness Program on YOGA | 21.06.2019 | 138 | KSRIET -YOGA CLUB |
| 4 | YOGA vs COVID | 11.09.2020 | 136 | KSRIET -YOGA CLUB |

PRINCIPAL

**K. S. R. KALVI NAGAR,
TIRUCHENGODE - 637 215,
NAMAKKAL Dt, TAMIL NADU.**



KSR INSTITUTE FOR ENGINEERING AND TECHNOLOGY

TIRUCHENGODE-637 215



National Service Scheme (NSS)

REF: KSRIET/NSS/CIR/2019-2020/07

Circular

DATE: 15/07/2019

Our KSRIET NSS is organizing a “**Blood Donation Camp**” on July 19th, 2019 (Friday) at our EEE Seminar hall from 10.00 AM to 02.00 PM in coordination with Lions club, Erode. We are inviting donors for donating the blood and Donors can start registering their name to Mr.A.Mohanraj, AP/Mech.

All are invited

NSS Programme officer

Principal

Copy to

- The Principal Office,
- All Department HODs,
- Common Notice Board.



PRINCIPAL,
K. S. R. INSTITUTE FOR
ENGINEERING AND TECHNOLOGY,
K. S. R. KAI VI NAGAR,
TIRUCHENGODE - 637 215,
NAMAKKAL DISTRICT, TAMIL NADU.

KSR INSTITUTE FOR ENGINEERING AND TECHNOLOGY

**National Service Scheme
"Blood Donation Camp" on 19/07/2019
Name List of Volunteers
Academic Year: 2019-2020**

The following students are permitted to attend the Programme:

| S.NO | NAME OF THE STUDENT | YEAR/DEPT |
|------|---------------------|-----------|
| 1. | AJAYKUMAR G | I-MECH |
| 2. | ARAVIND M | I-MECH |
| 3. | BHARANESH M | I-MECH |
| 4. | BOOPATHI P | I-MECH |
| 5. | DEEPA M | I-MECH |
| 6. | DHEENADHAYALAN B | I-MECH |
| 7. | EZHILVENDEN S | I-MECH |
| 8. | GOKULA KANNAN T | I-MECH |
| 9. | GOKULNATH S | I-MECH |
| 10. | HARISH P | I-MECH |
| 11. | HARISH U | I-MECH |
| 12. | HARIŞH KUMARR H V | I-MECH |
| 13. | JAICHANDRAN M | I-MECH |
| 14. | KARNAN S | I-MECH |
| 15. | KARTHIKEYAN G | I-MECH |
| 16. | KAVIYARASU R | I-MECH |
| 17. | KISHORE P | I-MECH |
| 18. | MANOJKUMAR E | I-IT |
| 19. | MYTHREYAN S | I-IT |
| 20. | NAVEEN N | I-IT |
| 21. | PANDIDURAI S | I-IT |
| 22. | PAVITHRA R | I-IT |
| 23. | POOVARASAN S | I-IT |
| 24. | PRATHAB J | I-IT |

PRINCIPAL,
K. S. R. INSTITUTE FOR
ENGINEERING AND TECHNOLOGY,
K. S. R. HALVEY ROAD,
TIRUCHENAI, DISTRICT 617 215,
NAMAKKAL Dt., Tamil Nadu.

| | | |
|-----|------------------------|-------|
| 25. | PRAVEEN D | I-IT |
| 26. | RAJESH KANNA K | I-IT |
| 27. | RANJITH B S | I-IT |
| 28. | RASIGA J | I-IT |
| 29. | ROJA SREE S | I-IT |
| 30. | SANDHIYA M | I-IT |
| 31. | SANJAY M | I-IT |
| 32. | SANTHOSHKUMAR B | I-IT |
| 33. | SHIVA SURYA VASAN S | I-IT |
| 34. | SRIDHARAN S | I-IT |
| 35. | SRILOGESH K S | I-IT |
| 36. | SUBHA V | I-IT |
| 37. | SUDHARSANAN N | I-IT |
| 38. | SANTHIYA K | II-IT |
| 39. | SATHIYAMOORTHY S R | II-IT |
| 40. | SELVA GANAPATHY S | II-IT |
| 41. | SENGOTTAIYAN G | II-IT |
| 42. | SRIMATHI E | II-IT |
| 43. | SRINIVASAN S | II-IT |
| 44. | VIGNESH R | II-IT |
| 45. | VISHNUCHAKKARAVARTHI M | II-IT |
| 46. | KAMALI R | II-IT |
| 47. | ANUNITHA J | I-EEE |
| 48. | ARUN KUMAR P | I-EEE |
| 49. | BHARANIDHARAN C | I-EEE |
| 50. | KARTHIKEYAN S P | I-EEE |
| 51. | KUMAR V | I-EEE |
| 52. | LOGESHWARAN P | I-EEE |
| 53. | LOGESWARI S | I-EEE |

PRINCIPAL.

K. S. R. INSTITUTE FOR
ENGINEERING AND TECHNOLOGY,
K. S. R. KALVINAGAR,
TIRUCHENGODE 637 215,
NAMAKKAL DISTRICT, TAMIL NADU.

| | | |
|-----|-------------------|---------|
| 54. | ABINANTHAN R | I-CSE |
| 55. | AMIRTHESWARI A | I-CSE |
| 56. | ARAVINTH R | I-CSE |
| 57. | ARIHARAN P | I-CSE |
| 58. | ARUL MURUGAN S | I-CSE |
| 59. | BOOBALAN S | II-MECH |
| 60. | CHANDRU K | II-MECH |
| 61. | DHANASEKAR D | II-MECH |
| 62. | DHARANEESHWARAN N | II-MECH |
| 63. | GOPINATH S | II-MECH |
| 64. | GOWTHAM K | II-MECH |
| 65. | JAYAPRAKASH S | II-MECH |
| 66. | MANIVASAGAM M | II-MECH |
| 67. | MONISHVARAN T | II-MECH |
| 68. | SUNMATHI R | I-ECE |
| 69. | SURYA B | I-ECE |
| 70. | UMABHARATHI C | I-ECE |
| 71. | VETRIKUMAR V | I-ECE |
| 72. | VIGNESH P | I-ECE |

NSS PROGRAMME OFFICER

PRINCIPAL

PRINCIPAL
K. S. R. INSTITUTE FOR
ENGINEERING AND TECHNOLOGY,
K. S. R. KAIYANAGAR,
TIRUCHENGODE - 617 215,
NAMAKKAL Dt. TAMIL NADU.

K S R INSTITUTE FOR ENGINEERING AND TECHNOLOGY

TIRUCHENGODE – 637 215

NATIONAL SERVICE SCHEME (NSS)

Blood Donation Camp– Report

Academic Year: 2019-20

| | | | |
|------------------------------------|---|--|------------------|
| Name of the Programme | Blood Donation Camp | | |
| Date & Time | 19/07/2019 & 10.00AM | Venue | EEE Seminar hall |
| Chief Guest/Resource Person | Dr.M.Venkatesan, Principal Dr.R.Nandhakumar HOD/ECE | No of NSS Volunteers involved in the activity | 25 |
| | | No of Beneficiaries | 72 |
| About Programme /Activity | <p>Our KSRIET NSS jointly organized with Lions club, the blood donation camp was organized on 19 July 2019 in our EEE Seminar hall. Our Principal Dr.M.Venkatesan, Dr.R.Nandhakumar HOD/ECE Inaugurated and provide certificates to the donors. In this programme 25 NSS Volunteers are utilized to arrange the programme and 72 students get benefited</p> | | |



Blood Donation Camp

NSS Coordinator

Principal



KSR INSTITUTE FOR ENGINEERING AND TECHNOLOGY

TIRUCHENGODE

National Service Scheme (NSS)



REF: KSRIET/NSS/CIR/2019-2020/12

Circular

DATE: 28/11/2019

In the view of WORLD AIDS DAY (December 01), Our KSRIET NSS has planned to organize "HIV AWARENESS PRORAM" for all NSS volunteers on 02 December, 2019 at 10.30 AM in our ECE Seminar hall.

NSS Programme officer

Principal

Copy to

- The Principal Office,
- All Department HODs,
- Common Notice Board.

PRINCIPAL,
K. S. R. INSTITUTE FOR
ENGINEERING AND TECHNOLOGY,
K. S. R. KALVI NAGAR,
TIRUCHENGODE - 637 215,
NAMAKKAL Dt, TAMIL NADU.

KSR INSTITUTE FOR ENGINEERING AND TECHNOLOGY
National Service Scheme
"HIV Awareness Program" on 02/12/2019
Name List of Volunteers
Academic Year: 2019-2020

The following students are permitted to attend the Programme:

| S.NO | NAME OF THE STUDENTS | YEAR/DEPT |
|------|----------------------|-----------|
| 1. | ABINANTHAN R | I-CSE |
| 2. | AMIRTHESWARI A | I-CSE |
| 3. | ARAVINTH R | I-CSE |
| 4. | ARIHARAN P | I-CSE |
| 5. | ARUL MURUGAN S | I-CSE |
| 6. | ARUNPRAKASH C | I-CSE |
| 7. | ASHWIN M | I-CSE |
| 8. | BARATH P | I-CSE |
| 9. | BHARATH KUMAR K | I-CSE |
| 10. | DEEPAN G | I-CSE |
| 11. | DHARSHA K | I-CSE |
| 12. | DHEVAK A | I-CSE |
| 13. | GANESH M | I-CSE |
| 14. | GAYATHRI K | I-CSE |
| 15. | GOBI B | I-CSE |
| 16. | HARIKRISHNAA S | I-CSE |
| 17. | HEMAMALINI G | I-CSE |
| 18. | ILAKIYA V | I-CSE |
| 19. | INDHUJA V | I-CSE |
| 20. | JEEVA M | I-CSE |
| 21. | RAGAVAN G V | I-ECE |
| 22. | RAJARAMAN K | I-ECE |
| 23. | RANJITH KUMAR P | I-ECE |

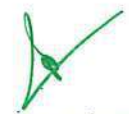
 PRINCIPAL
 K. S. R. INSTITUTE FOR
 ENGINEERING AND TECHNOLOGY,
 K. S. R. KALVI NAGAR,
 TIRUCHENGODE-637 215,
 NAMAKKAL Dt. TAMIL NADU.

| | | |
|-----|-------------------|--------|
| 24. | RAVIRAAGUL V | I-ECE |
| 25. | RENGE NAATHAN S | I-ECE |
| 26. | RUBAN NISANTH B | I-ECE |
| 27. | SAKTHIVEL S | I-ECE |
| 28. | SANJAY B | I-ECE |
| 29. | SARANYA S | I-ECE |
| 30. | SELVA BRINDHA K | I-ECE |
| 31. | SONIKA K M | I-ECE |
| 32. | SUNMATHI R | I-ECE |
| 33. | SURYA B | I-ECE |
| 34. | UMABHARATHI C | I-ECE |
| 35. | VETRIKUMAR V | I-ECE |
| 36. | VIGNESH P | I-ECE |
| 37. | VINITH K A | I-ECE |
| 38. | ADHITHIYABALA N | I-IT |
| 39. | ARAVINDH R | I-IT |
| 40. | ARAVINDHAN R | I-IT |
| 41. | DEETSHIDHAR L | I-IT |
| 42. | DEVESH K S | I-IT |
| 43. | DHARANIDHARAN D | I-IT |
| 44. | DHILIP P | I-IT |
| 45. | GOWSIKA R | I-IT |
| 46. | HARIHARAN S | I-IT |
| 47. | HARINI V | I-IT |
| 48. | GOKULA KANNAN T | I-MECH |
| 49. | GOKULNATH S | I-MECH |
| 50. | HARISH P | I-MECH |
| 51. | HARISH U | I-MECH |
| 52. | HARISH KUMARR H V | I-MECH |



PRINCIPAL,

K. S. R. INSTITUTE FOR
ENGINEERING AND TECHNOLOGY,

K. S. R. KALVI NAGAR,
TIRUCHENGODE-637 215,
NAMAKKAL Dt, TAMIL NADU.

| | | |
|-----|--------------------|--------|
| 53. | JAICHANDRAN M | I-MECH |
| 54. | SRIDHAR D | II-EEE |
| 55. | VIJAY E | II-EEE |
| 56. | ATHIF L | II-EEE |
| 57. | TAMILARASAN K | II-EEE |
| 58. | TAMILSELVAN A | II-EEE |
| 59. | PRASATH S | II-EEE |
| 60. | NITHYA M | II-ECE |
| 61. | PAVITHRA M | II-ECE |
| 62. | PONKAMALESH A | II-ECE |
| 63. | PRASANTH S | II-ECE |
| 64. | RAGAVAN V | II-ECE |
| 65. | RAGUL P | II-ECE |
| 66. | RANJITH G | II-ECE |
| 67. | SASI S | II-ECE |
| 68. | SATHISHKUMAR M | II-ECE |
| 69. | SATHYA R | II-ECE |
| 70. | SETHUPATHI R | II-ECE |
| 71. | SHALINI S | II-ECE |
| 72. | SURIYA A | II-ECE |
| 73. | THANGARAJ K | II-ECE |
| 74. | THULASI RAMAN S | II-ECE |
| 75. | VAISHNAVI K | II-ECE |
| 76. | YASODHA S | II-ECE |
| 77. | <u>MAHESH J</u> | II-ECE |
| 78. | <u>VIGNESH S K</u> | II-ECE |
| 79. | ANUNITHA J | I-EEE |
| 80. | ARUN KUMAR P | I-EEE |
| 81. | BHARANIDHARAN C | I-EEE |

 PRINCIPAL,
 K. S. R. INSTITUTE FOR
 ENGINEERING AND TECHNOLOGY,
 K. S. R. KALVI NAGAR,
 TIRUCHENGODE-637 215,
 NAMAKKAL Dt, TAMIL NADU.

| | | |
|------|----------------------------|--------|
| 82. | BOOPATHIRAJ K | I-EEE |
| 83. | DURGA S | I-EEE |
| 84. | JEEVANANTHAM SINGARAVEL | I-EEE |
| 85. | KARTHIKEYAN S P | I-EEE |
| 86. | KUMAR V | I-EEE |
| 87. | LOGESHWARAN P | I-EEE |
| 88. | LOGESWARI S | I-EEE |
| 89. | MANISHA M | I-EEE |
| 90. | MOHANKUMAR C | I-EEE |
| 91. | MUTHUKUMAR V | I-EEE |
| 92. | NANDHAKUMAR L | I-EEE |
| 93. | NANDHINI M | I-EEE |
| 94. | KARNAN S | I-MECH |
| 95. | KARTHIKEYAN G | I-MECH |
| 96. | KAVIYARASU R | I-MECH |
| 97. | KISHORE P | I-MECH |
| 98. | KRITHICKSHAN S | I-MECH |
| 99. | MANIKANDAN G | I-MECH |
| 100. | AARTHI M | II-CSE |
| 101. | BALAJI S | II-CSE |
| 102. | BHUVANSHANKAR B | II-CSE |
| 103. | CHENNAKRISHNAN S | II-CSE |
| 104. | DEVA PRASATH V | II-CSE |
| 105. | DHANUSHIYA V | II-CSE |
| 106. | GOKULAKRISHNAN B | II-CSE |
| 107. | GOWSALYA G | II-CSE |
| 108. | GOWSIKAN R | II-CSE |
| 109. | HARI BILGATES S | II-CSE |

 PRINCIPAL,
 K. S. R. INSTITUTE FOR
 ENGINEERING AND TECHNOLOGY
 K. S. R. KALVI NAGAR,
 TIRUCHENGODUR 637 215,
 NAMAKKAL DISTRICT, TAMIL NADU.

| | | |
|------|-------------------------|---------|
| 110. | HEMALATHA DEVI P | II-CSE |
| 111. | ISHWARYA R | II-CSE |
| 112. | JAILLESH K | II-CSE |
| 113. | JAYAC KEERTHANA S K | II-CSE |
| 114. | JOTHIVEL D | II-CSE |
| 115. | KAMAL G | II-CSE |
| 116. | KAVIN M | II-CSE |
| 117. | KAVIYA S | II-CSE |
| 118. | KAVIYA PRIYADHARSHINI M | II-CSE |
| 119. | KIRUTHIKA S | II-CSE |
| 120. | VENKATESH P | II-MECH |
| 121. | VIGNESH G | II-MECH |
| 122. | VIJAY S | II-MECH |
| 123. | VIKRAM S | II-MECH |
| 124. | YOGESH G | II-MECH |

D. M. S.
2/11/18
NSS PROGRAMME OFFICER

[Signature]
02/11/18
PRINCIPAL

[Signature]
PRINCIPAL,
K. S. R. INSTITUTE FOR
ENGINEERING AND TECHNOLOGY,
K. S. R. KALVI NAGAR,
TIRUCHENGODE-637 215,
NAMAKKAL Dt. TAMIL NADU.

K S R INSTITUTE FOR ENGINEERING AND TECHNOLOGY

TIRUCHENGODE – 637 215

NATIONAL SERVICE SCHEME (NSS)

HIV Awareness Program– Report

Academic Year: 2019-20

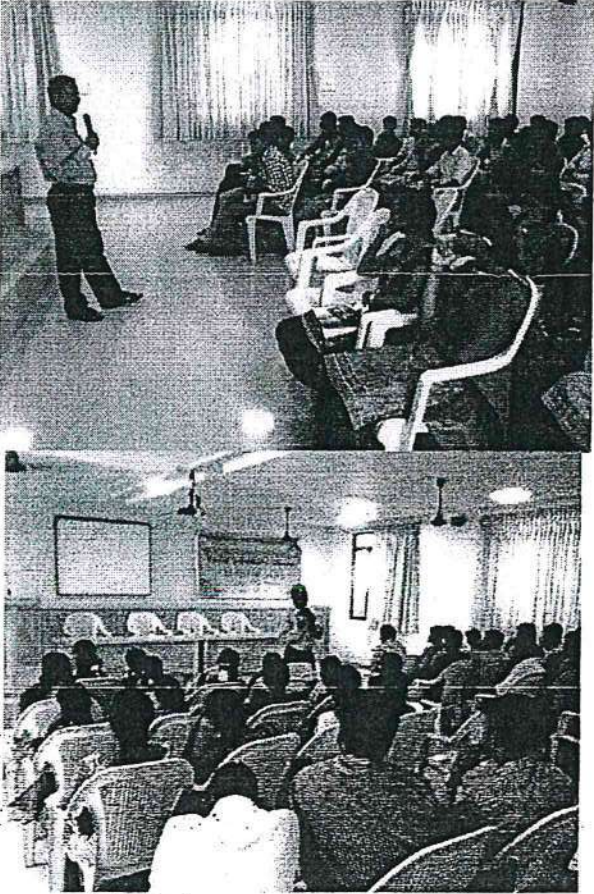
| | | | |
|--|--|--|------------------|
| Name of the Programme | HIV Awareness Program | | |
| Date & Time | 02/12/2019 & 10.30AM | Venue | ECE Seminar hall |
| Chief Guest/Resource Person | Mr.H.Santharam RRC-Salem | No of NSS Volunteers involved in the activity | 30 |
| | | No of Beneficiaries | 124 |
| About Programme /Activity | Our KSRIET NSS Organized HIV AWARENESS PROGRAMME in the name “Celebrating the Life” for our NSS Volunteers on 02 December 2019 at our ECE Seminar hall. Resource Person Mr.H.Santharam RRC, Salem Created the awareness among our NSS Volunteers | | |
|  <p style="text-align: center;">HIV Awareness program</p> | | | |

 PRINCIPAL,
 K. S. R. INSTITUTE FOR
 ENGINEERING AND TECHNOLOGY
 K. S. R. KALPAM ROAD,
 TIRUCHENGODE, TAMIL NADU

NSS Coordinator 

Principal 

PERMISSION LETTER

From

The Co-ordinator,
Yoga Club,
KSRIET,
Tiruchengode.

To

The Principal,
KSRIET,
Tiruchengode.

Respected Sir,

Sub. :- Requesting permission to conduct Awareness Program on YOGA – Reg.

In view of International Yoga day, Yoga club of our college has planned to conduct “**an awareness program on YOGA**” for our students and faculty members on 21.06.2019. Hence you are requested to give permission and do the needful.

Thanking you.

Yours faithfully,

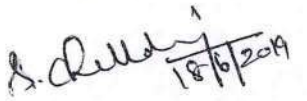
[S.CHELLADURAI]

Date: 18-06-2019

Place: KSRIET, Tiruchengode.

18/06/19

PRINCIPAL,
K. S. R. INSTITUTE FOR
ENGINEERING AND TECHNOLOGY,
K. S. R. KALVI NAGAR,
TIRUCHENGODE-637 215,
NAMAKKAL Dt. TAMIL NADU.

K S R INSTITUTE FOR ENGINEERING AND TECHNOLOGY

TIRUCHENGODE - 637 215

Ref.: KSRIET/YOGA/CIR/2019-20/001

DATE: 20.06.2019

YOGA CLUB

CIRCULAR

This is to inform all the HoDs, Faculty members & students that our Yoga Club is organizing "Awareness Program on YOGA" for the students & faculty members on 21.06.2019 in view of International Yoga Day. In this regard, Class advisors are asked to assemble the willing students in the respective venue as per the schedule given below.

| Time | Venue |
|---------------------|------------------------------|
| 9.00 am to 11.00 am | EEE Seminar Hall (For Girls) |
| | ECE Seminar Hall (For Boys) |
| | MECH Seminar Hall (For Boys) |

COORDINATOR
(YOGA CLUB)

PRINCIPAL

PRINCIPAL,
K. S. R. INSTITUTE FOR
ENGINEERING AND TECHNOLOGY,
K. S. R. KALVI NAGAR,
TIRUCHENGODE-637 215,
NAMAKKAL Dt. TAMIL NADU.

"Awareness programme on YOGA"

list of participants :

| S.No. | BRANCH | YEAR | NAME OF THE STUDENT |
|-------|--------|----------|---------------------|
| 1 | CSE | I YEAR | ARAVINTH R |
| 2 | | | DEEPAN G |
| 3 | | | DHARSHA K |
| 4 | | | INDHUJA V |
| 5 | | | JEEVA M |
| 6 | | | KRISHNAMOORTHY M |
| 7 | | | LOGESHWARAN G |
| 8 | | | MADHUMITHA M |
| 9 | | | YOGESH M |
| 10 | | II YEAR | ISHWARYA R |
| 11 | | | JAILLESH K |
| 12 | | | KIRUTHIKA S |
| 13 | | | MAHESHKUMAR K S |
| 14 | | | PRANESH KUMAR B |
| 15 | | | RAJKUMAR S |
| 16 | | | SUSHMA R |
| 17 | | | VENKATESH V |
| 18 | | | VISHNU PRASAD A |
| 19 | | III YEAR | BOOPALAN V |
| 20 | | | CHOWMIYA S B |
| 21 | | | DEEPAK KUMAR J |
| 22 | | | SURYA K |
| 23 | | | VAISHNAVI V |
| 24 | | | YUVASHREE R |
| 25 | | IV YEAR | ARUN R |
| 26 | | | BARATH K |
| 27 | | | LAXMANCIBI S |
| 28 | | | MANIKANDAN K |
| 29 | | | SHILPA B |
| 30 | EEE | I YEAR | LOGESWARI S |
| 31 | | | MANISHA M |
| 32 | | | PRAVEENA M |
| 33 | | | RAGUL P |
| 34 | | II YEAR | HEMALATHA S |
| 35 | | | JAMBUKESH I |
| 36 | | | MEIYARASU K |
| 37 | | | ATHIF L |
| 38 | | III YEAR | JEEVITHA G |
| 39 | | | KAMALAHASAN G |
| 40 | | | KARTHIKEYAN M |
| 41 | | | SHYAM PRASHAD S |
| 42 | | IV YEAR | NITHIYASRI R |
| 43 | | | PIREETHI A |
| 44 | | | VIVEK V |

 PRINCIPAL,
 K. S. R. INSTITUTE FOR
 ENGINEERING AND TECHNOLOGY,
 K. S. R. KALVI NAGAR,
 TIRUCHENGODE-637 215,
 NAMAKKAL DI. TAMIL NADU.

| S.No. | BRANCH | YEAR | NAME OF THE STUDENT |
|-------|--------------|-----------------|---------------------|
| 45 | ECE | I YEAR | BHAVYA S |
| 46 | | | DHINESHKUMAR S |
| 47 | | | PRAVEEN KUMAR S |
| 48 | | | RAGAVAN G V |
| 49 | | | SURYA B |
| 50 | | | UMABHARATHI C |
| 51 | ECE | II YEAR | AMUTHA K |
| 52 | | | DEEPTHEE M |
| 53 | | | DHAANU S |
| 54 | | | GOKUL K |
| 55 | | | HARI KRISHNAN D |
| 56 | | | JANARTHANAN S |
| 57 | | | NITHYA M |
| 58 | | | PAVITHRA M |
| 59 | | PONKAMALESH A | |
| 60 | | YASODHA S | |
| 61 | | MAHESH J | |
| 62 | | III YEAR | BOOMA V |
| 63 | | | DARANIDARAN R S |
| 64 | | | DHANISH V |
| 65 | | | LAKSHMANAN S |
| 66 | | | MADHANGOPAL C |
| 67 | PREMELA R | | |
| 68 | PRIYA R | | |
| 69 | SRIDHARAN M | | |
| 70 | IV YEAR | BRINDHA M | |
| 71 | | DANATHARSHINI G | |
| 72 | | JAYASHRI M | |
| 73 | | KAJAPATHY V | |
| 74 | | NAVANANDHINI E | |
| 75 | | NIVETHA T | |
| 76 | | POORNIMA N | |
| 77 | | SYED SALMAN N | |
| 78 | TAMILARASI S | | |
| 79 | MECH | I YEAR | ARAVIND M |
| 80 | | | BHARANESH M |
| 81 | | | KRITHICKSHAN S |
| 82 | | | MANIKANDAN G |
| 83 | | | RAKESH G G |
| 84 | | | SANDHIYA R |
| 85 | | | VALLIAPPAN S P |
| 86 | | | VIGNESH P |
| 87 | II YEAR | KRISHNAN S | |
| 88 | | MANIKANDAN P | |
| 89 | | RAMKUMAR S | |
| 90 | | SAMRAT G | |
| 91 | | SUDARSHAN R | |
| 92 | VENKATESH P | | |

| S.No. | BRANCH | YEAR | NAME OF THE STUDENT | | |
|-------|---------------|---------------------|------------------------|---------------|----------|
| 93 | | | SATHEESH KUMAR V | | |
| 94 | | | VIMALKUMAR V | | |
| 95 | | III YEAR | ARUN PRABAKARAN J | | |
| 96 | | | ASWANTH KUMAR K | | |
| 97 | | | BALAJI S | | |
| 98 | | | HARIPRASATH P | | |
| 99 | | | INDIRAJITH M | | |
| 100 | | | NAVEEN V | | |
| 101 | | | MECH | III YEAR | NIKHIL S |
| 102 | | | | | VINITH D |
| 103 | KANNAN E | | | | |
| 104 | IV YEAR | HARI SHANKAR P | | | |
| 105 | | JEEVA M | | | |
| 106 | | KIRUBAKARAN M | | | |
| 107 | | LAKSHMI NARAYANAN R | | | |
| 108 | | MOHANRAJ B | | | |
| 109 | | BALAJI M | | | |
| 110 | | SURENDHAR J | | | |
| 111 | | PRANESH S K | | | |
| 112 | | NAMBIRAJ J | | | |
| 113 | IT | I YEAR | BRETHIKA R D | | |
| 114 | | | CHIRADEEP B | | |
| 115 | | | DAMODHARAN M | | |
| 116 | | | THULASIVASAN V | | |
| 117 | | | VIKASHINI V | | |
| 118 | | | YOGASREE S | | |
| 119 | | II YEAR | ARAVINDHAN R | | |
| 120 | | | DEETSHIDHAR L | | |
| 121 | | | DEVESH K S | | |
| 122 | | | MUTHUMAHESH K | | |
| 123 | | | NIVEDHA V | | |
| 124 | | | VIGNESH R | | |
| 125 | | | VISHNUCHAKKARAVARTHI M | | |
| 126 | | | III YEAR | BALAMURUGAN S | |
| 127 | | CHANDRU M | | | |
| 128 | | DHANUSH ADIT R | | | |
| 129 | | KEERTHIVARMA K S | | | |
| 130 | | LAKSHMANAN R | | | |
| 131 | | MANIKANDAN A | | | |
| 132 | | IV YEAR | | ARUN KUMAR A | |
| 133 | | | BOOPALAN G | | |
| 134 | | | GOWRI D | | |
| 135 | | | JANANI T | | |
| 136 | | | KARKULAZHI S | | |
| 137 | SWETHA S | | | | |
| 138 | TAMILARASAN G | | | | |

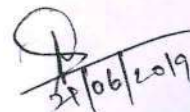

 PRINCIPAL,
 K. S. R. INSTITUTE FOR
 ENGINEERING AND TECHNOLOGY,
 K. S. R. KALVI NAGAR,
 TIRUCHENGODE-637 215,
 NAMAKKAL DI, TAMIL NADU

 29/06/2019
 COORDINATOR
 (YOGA CLUB)

K S R Institute for Engineering & Technology

International Yoga Day

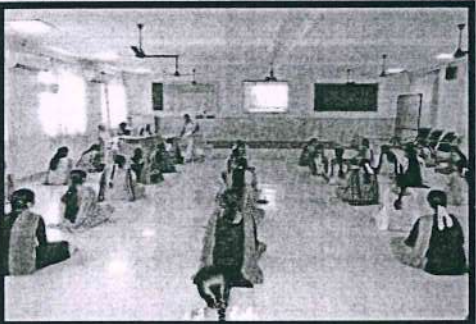
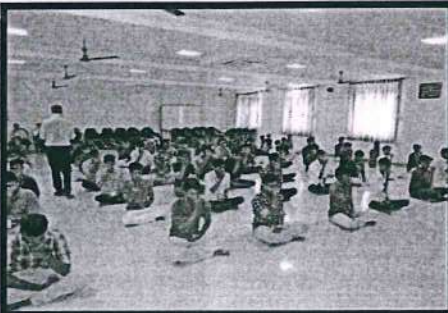
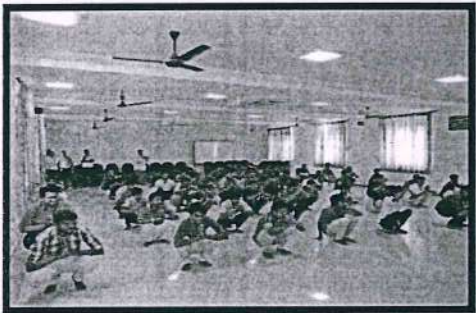
Awareness Programme - 21.06.2019



PRINCIPAL,
K. S. R. INSTITUTE FOR
ENGINEERING AND TECHNOLOGY,
K. S. R. KALVI NAGAR,
TIRUCHENGODE-637 215,
NAMAKKAL DISTRICT, TAMIL NADU.



KSR INSTITUTE FOR ENGINEERING AND TECHNOLOGY,
TIRUCHENGODE- 637215
YOGA CLUB

Report Summary

| | | | |
|-------------------------------|---|---------------------------------------|-------------------|
| Name of the Club: | Yoga Club | | |
| Academic Year: | 2019- 2020 | Date & Time: | 21.06.2019 & 9 am |
| Name of the Programme: | “ Awareness programme on YOGA ” | | |
| Venue: | EEE Seminar hall, ECE Seminar hall & MECH Seminarhall | No. of Participants Attended : | 138 |

Brief about the Program:

In order to create awareness about YOGA among our college students & Faculty members, Yoga Club has been conducting awareness programme every year.

In this academic year (2019-20) also, we have conducted an awareness programme on YOGA on 21.06.2019 from 9 am to 11 am. Around 138 students from various departments have participated in this awareness programme.

Three Trainers from Isha Yoga Centre, Coimbatore have explained the importance of YOGA to keep our body and mind healthy & taught some simple Yoga Exercises by playing the videos.

This programme was very useful to our students to keep both mental & physical health.

Coordinator
(Yoga Club)

Principal

PRINCIPAL,
K. S. R. INSTITUTE FOR
ENGINEERING AND TECHNOLOGY,
K. S. R. KALVI NAGAR,
TIRUCHENGODE-637 215,
NAMAKKAL Dt, TAMIL NADU.

PERMISSION LETTER

From

The Co-ordinator,
Yoga Club,
KSRIET,
Tiruchengode.

To

The Principal,
KSRIET,
Tiruchengode.

Respected Sir,

Sub. :- Requesting permission to conduct Awareness Program on YOGA – Reg.

Yoga club of our college has planned to conduct an awareness program on YOGA in the title “YOGA Vs COVID” for our first year students and faculty members on 11.09.2020 through online (Google meet). Hence you are requested to give permission and do the needful.

Thanking you.

Yours faithfully,

S. Chelladurai
7/9/20

[S.CHELLADURAI]

Date: 07-09-2020

Place: KSRIET, Tiruchengode.

S. Chelladurai
07/09/20

PRINCIPAL,
K. S. R. INSTITUTE FOR
ENGINEERING AND TECHNOLOGY,
K. S. R. KALVI NAGAR,
TIRUCHENGODE-637 215,
NAMAKKAL Dt. TAMIL NADU.

K S R INSTITUTE FOR ENGINEERING AND TECHNOLOGY

TIRUCHENGODE - 637 215

Ref.: KSRIET/YOGA/CIR/2020-21/001

DATE: 10.09.2020

YOGA CLUB

CIRCULAR

This is to inform all the HoDs, Faculty members & first year students that our Yoga Club is organizing Awareness Program on YOGA in the title "YOGA Vs COVID" for the students & faculty members on 11.09.2020 at 10.00 am through online (Google meet). The interested first year students and faculty members can participate in this programme.

10/9/20
COORDINATOR
(YOGA CLUB)

10/09/20
PRINCIPAL

PRINCIPAL,
K. S. R. INSTITUTE FOR
ENGINEERING AND TECHNOLOGY,
K. S. R. KALVI NAGAR,
TIRUCHENGODE-637 215,
NAMAKKAL DI, TAMIL NADU.

"YOGA Vs COVID"

list of participants :

| S.No. | Year/ Branch | NAME OF THE STUDENT |
|-------|-----------------|---------------------|
| 1 | | AJITH S |
| 2 | | ARJUN K |
| 3 | | ARULMURUGAN V |
| 4 | | BRINDHA L |
| 5 | | DEEPA R |
| 6 | | DHARANI S |
| 7 | | DHARSHINI N |
| 8 | | DIVYA R |
| 9 | | DURGADEVI K S |
| 10 | | ELANGUMARAN T |
| 11 | | GNANAMOORTHY M |
| 12 | | GOKULA KANNAN M |
| 13 | | HARIPRASATH S G |
| 14 | | HARISHKUMAR J |
| 15 | I/CSE | KAVINRAJ D |
| 16 | | KAVISHNI S |
| 17 | | KIRIJA R |
| 18 | | KRISHANI M |
| 19 | | KRITHIKA R |
| 20 | | MALARVIZHI K |
| 21 | | PRIYADHARSHINI S |
| 22 | | RAGHUL K |
| 23 | | SABARIMUGILAN M |
| 24 | | SANJAI R |
| 25 | | SANJAY M |
| 26 | | THILOTHAMA D |
| 27 | | VIBIN S |
| 28 | | VINOTH R |
| 29 | | YAMUNA K |
| 30 | | AJAYKANTH S |
| 31 | | CHANDRU R |
| 32 | | GNANA VEL G |
| 33 | | GOKULRAJ S |
| 34 | | GUNASEKARAN S |
| 35 | | JANARTHANAN T |
| 36 | | KALAIYARASAN G |
| 37 | I/EEE | KARTHEESWARAN A U |
| 38 | | KARTHICK E |
| 39 | | KIRUTHIKA S |
| 40 | | MAYURI M |
| 41 | | NANDHINI K |
| 42 | | SARANYA M |
| 43 | | SARANYA P |
| 44 | | SRIRAM PRASATH P |
| 45 | | ARAVINTH K |
| 46 | | ASHIKA R |
| 47 | I/ECE | ASHOK KUMAR E |
| 48 | | BHUVANESWARI V |
| 49 | | DEEPAK M |
| 50 | | DHARSHAN R |

| S.No. | Year/ Branch | NAME OF THE STUDENT |
|-------|-----------------|------------------------|
| 51 | | DHINAGARAN J |
| 52 | | GOKULNATH S |
| 53 | | GOKUL RAJ D |
| 54 | | PRABHU M A |
| 55 | | PRANESH R |
| 56 | | PRAVEEN T |
| 57 | | PRAVEEN KUMAR G |
| 58 | | RAMYA DEVI M |
| 59 | | RANJANI T |
| 60 | | SACHITANANTHAN V |
| 61 | I/ECE | SAKTHIVEL V |
| 62 | | SANJAY P S |
| 63 | | SIVARAYAKRISHNAN R |
| 64 | | SOWMIYA C |
| 65 | | SUBASHINI K |
| 66 | | SURYA NARAYANA KUMAR G |
| 67 | | SURYAPRASATH M |
| 68 | | SUVASHINI M |
| 69 | | VIKRAMAN D |
| 70 | | VIVEKA S |
| 71 | | YAMINI H J |
| 72 | | AKASH R |
| 73 | | ASHOK KUMAR R G |
| 74 | | BHARATH V |
| 75 | | DHARUN S |
| 76 | | DINESHKUMAR R |
| 77 | I/MECH | KAVIYARASU |
| 78 | | KIRUBAKARAN R |
| 79 | | NAVETHITHA A A |
| 80 | | PRATHAP P |
| 81 | | SANJEEV KUMAR M |
| 82 | | SUBASH S |
| 83 | | VINOTH M |
| 84 | | AAKASH B |
| 85 | | AAKASH RAJ A |
| 86 | | ABINESH S |
| 87 | | DHANAYANTH A |
| 88 | | DHANUSH S |
| 89 | | DHANUSHIYA E |
| 90 | | ENIYAVAL K |
| 91 | | GOKUL SANJAI V |
| 92 | I/IT | GOPINATH G |
| 93 | | GOWTHAM S |
| 94 | | HEMALATHA T |
| 95 | | JAGAN M |
| 96 | | JAI GANESH N V |
| 97 | | KARTHICK G |
| 98 | | MADHAVAN K |
| 99 | | MADHUSUDHANAN K |
| 100 | | MOHAMED SHAHID V M |

| S.No. | Year/ Branch | NAME OF THE STUDENT |
|-------|-----------------|----------------------|
| 101 | I/IT | RAGUL V |
| 102 | | RANJITH KUMAR E |
| 103 | | RAVICHANDRU T |
| 104 | | SANTHOSH S |
| 105 | | SANTHRU V |
| 106 | | SHANMATHI DEVI L |
| 107 | | SRIRAMU D |
| 108 | | SUBASH CHANDRABOSE M |
| 109 | | SUGESHKANNAN M |
| 110 | | VENGATESAN M |
| 111 | | VINOTHKUMAR M |
| 112 | | YUVANRAJA S |
| 113 | I/BME | AGALYA R |
| 114 | | ARULMURUGAN R |
| 115 | | BHARATH KUMAR M |
| 116 | | DARVIN V |
| 117 | | GOBINESHWARI I |
| 118 | | GOWSHEEBA S R |
| 119 | | HARIHARAN S |
| 120 | | KAVIARASU R |
| 121 | | KAVINKUMAR M |
| 122 | | KEERTHANADEV I M |
| 123 | | MAHESWARI S |
| 124 | | MONISH C |
| 125 | | MUGILAN R |
| 126 | | PARTHIBAN V |
| 127 | | PRAVEEN E |
| 128 | | PRAVEEN S |
| 129 | | SANTHOSH KUMAR S |
| 130 | | SARVESH R |
| 131 | | SUDHES V |
| 132 | | SURESH RAJAN S |
| 133 | | VIMALNATH S |
| 134 | | VINOTH G |
| 135 | | VISHNURAM S R |
| 136 | | YASPE FRANCIS M V |

| S.No. | DEPT. | NAME OF THE FACULTY |
|-------|-----------|----------------------|
| 1 | ENGLISH | Dr. C. MUHUNTHARAJAN |
| 2 | | S. MADHAN |
| 3 | | P. MOHAN |
| 4 | MATHS | M. ASICK ALI |
| 5 | | R. KAVITHA |
| 6 | | P. UMA DEVI |
| 7 | PHYSICS | Dr. J. C. KANNAN |
| 8 | | Dr. V. DEVA BHARATHI |
| 9 | CHEMISTRY | Dr. B. MURUGESAN |
| 10 | | S. AGILADEVI |
| 11 | | S. CHELLADURAI |

11/9/2020

COORDINATOR
(YOGA CLUB)

PRINCIPAL,
K. S. R. INSTITUTE FOR
ENGINEERING AND TECHNOLOGY,
K. S. R. KALVI NAGAR,
TIRUCHENGODE-637 215,
NAMAKKAL Dt. TAMIL NADU.

K S R Institute for Engineering & Technology

YOGA Vs COVID

Awareness Programme - 11.09.2020



PRINCIPAL,
K. S. R. INSTITUTE FOR
ENGINEERING AND TECHNOLOGY,
K. S. R. KALVI NAGAR,
TIRUCHENGODE-637 215,
NAMAKKAL D., TAMIL NADU.

Report Summary

| | | | |
|-------------------------------|---|---------------------------------------|--------------------|
| Name of the Club: | Yoga Club | | |
| Academic Year: | 2020- 2021 | Date &Time: | 11.09.2020 & 10 am |
| Name of the Programme: | "YOGA Vs COVID" | | |
| Venue: | Through online (Google meet) https://meet.google.com/kbe-npoc-hcr | No. of Participants Attended : | 147 |

| | |
|---|---|
| <u>Resource Person</u> |  |
| <p>Mr. BALAMURUGAN Yoga Teacher, Isha Yoga Centre, Coimbatore.</p> | |

Brief about the Program:

In order to create awareness about YOGA among our college students & Faculty members, Yoga Club has been conducting various awareness programmes every year.

In this academic year (2020-21) also, we have conducted an awareness programme on YOGA in the title "YOGA Vs COVID" on 11.09.2020 at 10 am through online (Google meet) using the link <https://meet.google.com/kbe-npoc-hcr>.

There are 136 first year students & 11 faculty members from various departments have participated in this awareness programme.

Our resource person **Mr. BALAMURUGAN**, Yoga Teacher, Isha Yoga Centre, Coimbatore have explained the importance of YOGA to fight against COVID & taught some simple Yoga Exercises by playing the videos.

This programme is very useful to both students & faculty members of our college to keep our health well & fight against COVID – 19.

 12/9/2020
Coordinator
 (Yoga Club)

 12/09/20
Principal

PRINCIPAL,
K. S. R. INSTITUTE FOR
ENGINEERING AND TECHNOLOGY,
K. S. R. KALVI NAGAR,
TIRUCHENGODE-637 215,
NAMAKKAL Dt, TAMIL NADU.

4. ICT/COMPUTING SKILLS

K S R INSTITUTE FOR ENGINEERING AND TECHNOLOGY

ICT/COMPUTING SKILLS CONSOLIDATED LIST

Academic Year:2019-2020

| S.NO. | Name of the capability enhancement program | Date of implementation (DD-MM-YYYY) | Number of students enrolled | Name of the agencies/consultants involved with contact details (if any) |
|--------------|---|--|------------------------------------|--|
| 1 | Technical C Training (External) | 03.06.2019 | 41 | Aaron Technologies, info@aarontec.com |
| 2 | Internal C Training | 03.06.2019 | 33 | KSRIET, placement@ksriet.ac.in |
| 3 | Internal C Training | 10.06.2019 | 79 | KSRIET, placement@ksriet.ac.in |
| 4 | External Technical C Training | 24.06.2019 | 43 | Aaron Technologies, info@aarontec.com |
| 5 | TCS Ninja Specific Training | 03.07.2019 | 15 | KSREI - CPC, placement@ksrei.org |
| 6 | External Technical Java Training | 21.07.2019 | 41 | Aaron Technologies, info@aarontec.com |
| 7 | External Technical Training | 24.08.2019 | 41 | Aaron Technologies, info@aarontec.com |
| 8 | External Java Training | 03.09.2019 | 41 | Aaron Technologies, info@aarontec.com |
| 9 | Internal Full Stack Development programme | 20.12.2019 | 126 | KSRIET, placement@ksriet.ac.in |

PRINCIPAL,
K. S. R. INSTITUTE FOR
ENGINEERING AND TECHNOLOGY,
K. S. R. KALVI NAGAR,
TIRUCHENGODE-637 215,
NAMAKKAL Dt, TAMIL NADU.

| | | | | |
|----|--|------------|-----|-------------------------------------|
| 10 | Virtusa Software Manual Testing | 08.01.2020 | 15 | KSREI - CPC, placement@ksrei.org |
| 11 | Amazon shortlist students: C & Data Structure | 10.01.2020 | 5 | KSREI - CPC, placement@ksrei.org |
| 12 | Top Freshers Technical Training Programme C & Python Phase I | 17.02.2020 | 14 | KSREI - CPC, placement@ksrei.org |
| 13 | Top Freshers Technical Training Phase II | 02.03.2020 | 9 | KSREI - CPC, placement@ksrei.org |
| 14 | Technical Java & Python Training Programme | 20.04.2020 | 147 | KSREI - CPC, placement@ksrei.org |
| 15 | AUTOCAD | 01.07.2019 | 72 | ksriet,hod_mech@ksriet.ac.in |
| 16 | CREO - AUTOMATION AND PRODUCTION | 17.06.2019 | 103 | ksriet,hod_mech@ksriet.ac.in |
| 17 | COMPUTER NUMERICAL CONTROL (CNC) | 04.10.2020 | 50 | ksriet,hod_mech@ksriet.ac.in |
| 18 | CREO- INDUSTRIAL DESIGN | 08.06.2020 | 35 | ksriet,hod_mech@ksriet.ac.in |

PRINCIPAL

PRINCIPAL,
K. S. R. INSTITUTE FOR
ENGINEERING AND TECHNOLOGY,
K. S. R. KALVI NAGAR,
TIRUCHENGODE - 637 215,
NAMAKKAL Dt, TAMIL NADU.

Scan

TRAINING AND PLACEMENT CELL

Training Schedule [2019 - 2020] ODD Semester



Ref: KSRIET/T&P/CIR/2019-20

Date: 29.05.2019

This is to inform that all the HoD's and Training and Placement coordinators that the Five days Technical C Training Programme planned for IV year students (2016 -2020 Batch) From 03.06.2019 to 08.06.2019 by Aasaithambi J, Aaron Technologies for the academic year 2019 - 2020 (Odd Sem) .All the registered students should attend the Training Programme without fail. If any student skips this Training Programme he / she will not be permitted for any further Training Programme and campus recruitment process. Proper Dress Code is mandatory.

T&P OFFICER
29/5/19

T&P COORDINATOR
29/5/19

PRINCIPAL
29/5/19

Copy to:

1. All HoDs
2. Notice Board

PRINCIPAL,
K. S. R. INSTITUTE FOR
ENGINEERING AND TECHNOLOGY,
K. S. R. CAMPUS,
TIRUCHENGODE - 637 215,
NAMAKKAL DISTRICT, TAMIL NADU.

BATCH : 2016 - 2020

Academic Year: 2019 - 2020

| Date of Training Programme | | | | 03.06.19 | | 04.06.2019 | | 05.06.2019 | | 07.06.2019 | | 07.06.2019 | |
|----------------------------|--------------|-------------------|--------|----------|----|------------|----|------------|----|------------|----|------------|----|
| S. No | Reg No | Name | Branch | FN | AN | FN | AN | FN | AN | FN | AN | FN | AN |
| 1 | 731616104005 | BARATH.K | CSE | / | / | / | / | / | / | / | / | / | / |
| 2 | 731616104011 | GOWTHAMAKUMARAN.P | CSE | / | / | / | / | P | P | / | / | / | / |
| 3 | 731616104018 | KAMALESH.M | CSE | / | / | / | / | P | P | / | / | / | / |
| 4 | 731616104026 | PAVITHIRAN.S | CSE | P | P | / | / | / | / | / | / | / | / |
| 5 | 731616104047 | VISVESWARAN.B | CSE | / | / | / | / | / | / | / | / | / | / |
| 6 | | SILPHA | CSE | / | / | / | / | / | / | / | / | / | / |
| 7 | 731616104045 | VENMATHI | CSE | / | / | / | / | / | / | / | / | / | / |
| 8 | 731616205006 | BOOPALAN G | IT | / | / | / | / | / | / | / | / | / | / |
| 9 | 731616205017 | KARKULAZHI S | IT | / | / | / | / | / | / | / | / | / | / |
| 10 | 731616205019 | KAUSALYA J | IT | / | / | / | / | / | / | / | / | / | / |
| 11 | 731616205020 | KIRUBAKARAN R | IT | / | / | / | / | / | / | / | / | / | / |
| 12 | 731616205024 | MOUNIKA S | IT | / | / | / | / | / | / | / | / | / | / |
| 13 | 731616205027 | PRATHAP KUMAR E | IT | / | / | / | / | / | / | / | / | / | / |
| 14 | 731616205033 | SATHAS R | IT | / | / | / | / | P | P | / | / | / | / |
| 15 | 731616205039 | SWETHA S | IT | / | / | / | / | / | / | / | / | / | / |
| 16 | 731616106006 | ANANTH N | ECE | / | / | / | / | / | / | / | / | / | / |
| 17 | 731616106013 | BHUVANESHWARI P | ECE | / | / | / | / | / | / | / | / | / | / |
| 18 | 731616106014 | BRAHADEESHWARAN M | ECE | / | / | / | / | / | / | / | / | / | / |
| 19 | 731616106015 | BRINDHA M | ECE | / | / | / | / | P | P | / | / | / | / |
| 20 | 731616106017 | DHARANI V | ECE | / | / | / | / | P | P | / | / | / | / |
| 21 | 731616106019 | DINESHKRISHNA S | ECE | / | / | / | / | / | / | / | / | A | A |
| 22 | 731616106021 | DURAIRAJ S | ECE | / | / | / | / | / | / | / | / | / | / |
| 23 | 731616106022 | ELANGO VAN V | ECE | / | / | / | / | / | / | / | / | / | / |
| 24 | 731616106024 | GOWTHAM M | ECE | / | / | / | / | / | / | / | / | / | / |
| 25 | 731616106029 | JAYASHRI M | ECE | / | / | / | / | / | / | / | / | / | / |
| 26 | 731616106031 | KANIMOZHI R | ECE | / | / | / | / | / | / | / | / | / | / |
| 27 | 731616106032 | KARTHIKEYAN S | ECE | / | / | / | / | / | / | / | / | / | / |
| 28 | 731616106033 | KARTHIKEYAN V | ECE | / | / | / | / | / | / | / | / | / | / |
| 29 | 731616106034 | KOKILA K | ECE | A | A | / | / | / | / | / | / | / | / |
| 30 | 731616106036 | LOGESH KUMAR K | ECE | / | / | / | / | / | / | / | / | / | / |
| 31 | 731616106040 | MEENA A | ECE | / | / | / | / | / | / | / | / | / | / |
| 32 | 731616106042 | MONIKA R | ECE | / | / | / | / | / | / | / | / | / | / |
| 33 | 731616106056 | PRIYANKA C | ECE | / | / | / | / | / | / | P | P | A | A |
| 34 | 731616106062 | SANTHIA G | ECE | / | / | / | / | / | / | / | / | / | / |
| 35 | 731616106079 | Suriya E | ECE | / | / | / | / | P | P | / | / | / | / |
| 36 | 731616106079 | THANGAVEL P | ECE | / | / | / | / | P | P | A | A | A | A |

| Date of Training Programme | | | | 03.06.19 | | 04.06.2019 | | 05.06.2019 | | 07.06.2019 | | 07.06.2019 | |
|----------------------------|--------------|----------------|--------|----------|----|------------|----|------------|----|------------|----|------------|----|
| S. No | Reg No | Name | Branch | FN | AN | FN | AN | FN | AN | FN | AN | FN | AN |
| 37 | 731616106082 | Vignesh R | ECE | / | / | / | / | / | / | / | / | / | / |
| 38 | 731616106302 | E.NAVANANDHINI | ECE | / | / | / | / | / | / | / | / | / | / |
| 39 | | ABISHEK | ECE | / | / | / | / | / | / | / | / | / | / |
| 40 | 731616105304 | HARIHARAN.R | EEE | / | / | / | / | / | / | / | / | / | / |
| 41 | 731616105305 | KARTHIK | EEE | / | / | / | / | / | / | / | / | / | / |
| PRESENT | | | | 39 | 39 | 41 | 41 | 34 | 34 | 39 | 39 | 38 | 38 |
| ABSENT | | | | 1 | 1 | 0 | 0 | 0 | 0 | 1 | 1 | 3 | 3 |
| PERMISSION | | | | 1 | 1 | 0 | 0 | 7 | 7 | 1 | 1 | 0 | 0 |

PRINCIPAL.
K. S. R. INSTITUTE FOR
ENGINEERING AND TECHNOLOGY,
K. S. R. KALMI NAGAR,
TIRUCHENGODE-637 215,
NAMAKKAL DI, TAMIL NADU.

**K S R INSTITUTE FOR ENGINEERING AND TECHNOLOGY
TIRUCHENGODE - 637 215**

TRAINING PROGRAMME FEEDBACK FORM



Name of the Student: Karthikeyan V Branch: ECE

Year / Sem: IV / VII

1. Name of the Training : Technical C Training

2. Name of the Trainer : Aasai Thambi

3. Students rating of Trainers :

| S. No. | Date | Subject | Rating (√) | | | |
|--------|------------------------|-------------------------|------------|-----------|------|---------|
| | | | Excellent | Very good | Good | Average |
| 1 | 3-6-19 to 8-6-19 | Technical C Training | ✓ | | | |

4. Two positive points about the programme:

Informative Session

5. Suggestions for improvement:

Need more Practicals

Date: 8-6-19

Karthikeyan V.
Signature

**K S R INSTITUTE FOR ENGINEERING AND TECHNOLOGY
TIRUCHENGODE - 637 215**

TRAINING PROGRAMME FEEDBACK FORM



Name of the Student: Vinmesh R. Branch: ECE

Year / Sem: IV / VII

1. Name of the Training : Technical C training

2. Name of the Trainer : Aasai Thambi

3. Students rating of Trainers :

| S. No. | Date | Subject | Rating (√) | | | |
|--------|------------------------|-------------------------|------------|-----------|------|---------|
| | | | Excellent | Very good | Good | Average |
| 1 | 3-6-19 to 8-6-19 | Technical C training | ✓ | | | |

4. Two positive points about the programme:

5. Suggestions for improvement:

Date: 8/6/19.

PRINCIPAL,
K. S. R. INSTITUTE FOR
ENGINEERING AND TECHNOLOGY,
K. S. R. KALMISAGAR,
TIRUCHENGODE - 637 215,
NAMAKKAL DISTRICT, TAMIL NADU.

Vinmesh R.
Signature

TRAINING AND PLACEMENT CELL



Internal C Training

Ref: KSRIET/T&P/CIR/2019-20

Date: 30.05.2019

This is to inform that all the HoD's, Class Advisor and Training and Placement coordinators that we have planned programming Training for IV Year students topics on "Internal C Training" (2016- 2020 batch) on from 03.06.2019-07.06.2019 at ECE Seminar Hall by R.Gopal AP/CSE for the academic year 2019 - 2020 (Odd Sem). All the Registered students should attend the training without fail.

| S.NO | Date & Time | Eligible Students Count |
|------|-----------------------------|--------------------------------------|
| 1 | 03.06.2019 to 07.06.2019 | CSE- 4, ECE - 5,EEE - 19 & IT - 5 |

[Signature]
T&P OFFICER

[Signature]
20/5/19
T&P COORDINATOR

[Signature]
PRINCIPAL

Copy to:

1. All HoDs
2. Notice Board

PRINCIPAL,
K. S. R. INSTITUTE FOR
ENGINEERING AND TECHNOLOGY,
K. S. R. KALVI NAGAR,
TIRUCHENGODE - 637 215,
NAMAKKAL Dt, TAMIL NADU.

K S R INSTITUTE FOR ENGINEERING AND TECHNOLOGY, Tiruchengode

Training and Placement Cell

Internal C Training Attendance Only Placement Registered but Not in Java & FSD(Odd Semester)

BATCH : 2016 - 2020

Academic Year: 2019 - 2020

| Date of Training Programme | | | | 03.06.2019 | | 04.06.2019 | | 06.06.2019 | | 07.06.2019 | |
|----------------------------|--------------|-------------------------|--------|------------|----|------------|----|------------|----|------------|----|
| S. No | Reg No | Name | Branch | FN | AN | FN | AN | FN | AN | FN | AN |
| 1 | 731616104001 | AJITH KUMAR.P | CSE | A | A | A | A | A | A | A | A |
| 2 | 731616104015 | INDIRA PRIYADHARSHINI.P | CSE | A | A | A | A | A | A | A | A |
| 3 | 731616104016 | JAYAVARSHINI.G | CSE | A | A | A | A | A | A | A | A |
| 4 | 731616104901 | KRISHNA GANTH T A | CSE | A | A | A | A | A | A | A | A |
| 5 | 731616106008 | ARULIEESWARAN R | ECE | / | / | / | / | / | / | A | A |
| 6 | 731616106059 | RANJITH V | ECE | A | A | A | A | A | A | A | A |
| 7 | 731616106064 | SATHYAMOORTHI K | ECE | A | A | A | A | A | A | A | A |
| 8 | 731616106078 | THANGARAJ J | ECE | A | A | A | A | A | A | A | A |
| 9 | 731616106083 | VIMAL KUMAR R | ECE | A | A | A | A | A | A | A | A |
| 10 | 731616105005 | ARAVIND R | EEE | / | / | / | / | / | / | / | / |
| 11 | 731616105006 | BHARATH S | EEE | / | / | / | / | / | / | / | / |
| 12 | 731616105008 | BOOPATHI M | EEE | / | / | / | / | / | / | / | / |
| 13 | 731616105011 | GANESHBABU V | EEE | A | A | A | A | A | A | A | A |
| 14 | 731616105012 | INIYA DHARINI R | EEE | / | / | / | / | / | / | A | A |
| 15 | 731616105014 | JEEVA M | EEE | / | / | / | / | / | / | / | / |
| 16 | 731616105015 | JEEVA R | EEE | / | / | / | / | / | / | / | / |
| 17 | 731616105021 | LATHA S | EEE | / | / | / | / | / | / | / | / |
| 18 | 731616105022 | LOGESHWARAN V | EEE | / | / | / | / | / | / | / | / |
| 19 | 731616105023 | MADHUMITHA J S | EEE | / | / | / | / | / | / | / | / |
| 20 | 731616105024 | MANOJKUMAR V | EEE | / | / | / | / | / | / | / | / |
| 21 | 731616105028 | MONISHA S | EEE | / | / | / | / | / | / | / | / |
| 22 | 731616105033 | NAVANEETHAN S | EEE | / | / | / | / | / | / | / | / |
| 23 | 731616105035 | PIREETHIA | EEE | / | / | / | / | / | / | / | / |
| 24 | 731616105037 | PRAVEEN.D | EEE | / | / | / | / | / | / | / | / |
| 25 | 731616105040 | PREMKUMAR.G | EEE | P | P | / | / | / | / | / | / |
| 26 | 731616105042 | SARAVANAN.V | EEE | / | / | / | / | / | / | / | / |
| 27 | 731616105303 | EMAIYA.K | EEE | / | / | / | / | / | / | / | / |
| 28 | 731616105306 | RATHNAKUMAR.V | EEE | / | / | / | / | / | / | / | / |
| 29 | 731616205001 | AHAMED FAISHAL H | IT | A | A | A | A | A | A | A | A |
| 30 | 731616205012 | INDHUMATHI S | IT | / | / | / | / | / | / | / | / |
| 31 | 731616205018 | KARTHIKA M | IT | / | / | / | / | / | / | / | / |
| 32 | 731616205032 | SATHAMHUSSAIN M S | IT | A | A | A | A | A | A | A | A |
| 33 | 731616205043 | VINOTH M | IT | A | A | / | / | A | A | A | A |
| PRESENT | | | | 20 | 20 | 22 | 22 | 21 | 21 | 19 | 19 |
| ABSENT | | | | 12 | 12 | 11 | 11 | 12 | 12 | 14 | 14 |
| PERMISSION | | | | 1 | 1 | 0 | 0 | 0 | 0 | 0 | 0 |

PRINCIPAL,
K. S. R. INSTITUTE FOR
ENGINEERING AND TECHNOLOGY,
K. S. R. HALLI NAGAR,
TIRUCHENGODE - 637 215,
NAMAKKAL Dt, TAMIL NADU.

**K S R INSTITUTE FOR ENGINEERING AND TECHNOLOGY
TIRUCHENGODE - 637 215**

TRAINING PROGRAMME FEEDBACK FORM



Name of the Student: Thangaraj J Branch: ECE

Year / Sem: IV/VII

1. Name of the Training: Internal C Training

2. Name of the Trainer: R. Gopal

3. Students rating of Trainers :

| S. No. | Date | Subject | Rating (✓) | | | |
|--------|--------|---------------------|------------|-----------|------|---------|
| | | | Excellent | Very good | Good | Average |
| 1 | 7/6/19 | Internal C Training | | ✓ | | |

4. Two positive points about the programme:

* Real time Concepts good

5. Suggestions for improvement:

Date: 7/6/19

Thangaraj J.
Signature

**K S R INSTITUTE FOR ENGINEERING AND TECHNOLOGY
TIRUCHENGODE - 637 215**

TRAINING PROGRAMME FEEDBACK FORM



Name of the Student: Jayashree G Branch: CSE

Year / Sem: IV/VII

1. Name of the Training: Internal C Training

2. Name of the Trainer: R. Gopal AP/CSE

3. Students rating of Trainers :

| S. No. | Date | Subject | Rating (✓) | | | |
|--------|--------|---------------------|------------|-----------|------|---------|
| | | | Excellent | Very good | Good | Average |
| 1 | 7.6.19 | Internal C Training | | ✓ | | |

4. Two positive points about the programme:

Training was excellent

5. Suggestions for improvement:

Date: 7/6/19

PRINCIPAL,
K. S. R. INSTITUTE FOR
ENGINEERING AND TECHNOLOGY,
K. S. R. SALVI NAGAR,
TIRUCHENGODE - 637 215,
NANDYAL DE, TAMIL NADU.

Signature

K S R INSTITUTE FOR ENGINEERING AND TECHNOLOGY,

TIRUCHENGODE - 637 215

TRAINING AND PLACEMENT CELL

Training Schedule [2019 - 2020] Odd Semester



Ref: KSRIET/T&P/CIR/2019-20

Date: 08.06.2019

This is to inform that all the HoD's, Class Advisor and Training and Placement coordinators that the one week Internal C Training " is planned for Final year students on from 10.06.2019 to 14.06.2019 at ECE Seminar hall by by Mr.S.Nandhagopal AP/IT for the academic year 2019 - 2020.

T&P OFFICER

T&P COORDINATOR

PRINCIPAL

Copy to:

1. All HoDs
2. Notice Board

PRINCIPAL,
K. S. R. INSTITUTE FOR
ENGINEERING AND TECHNOLOGY,
K. S. P. KAVI NAGAR,
TIRUCHENGODE - 637 215,
NAMBAKAL Dt, TAMIL NADU.

K S R INSTITUTE FOR ENGINEERING AND TECHNOLOGY, Tiruchengode

Training and Placement Cell

Batch 1 - Internal C Training Attendance for MECH (Odd Semester)

BATCH : 2016 - 2020

Academic Year: 2019 - 2020

| Date of Training Programme | | | | 10.06.2019 | | 11.06.2019 | | 12.06.2019 | | 13.06.2019 | | 14.06.2019 | |
|----------------------------|--------------|-----------------------|--------|------------|----|------------|----|------------|----|------------|----|------------|----|
| S. No | Reg No | Name | Branch | FN | AN | FN | AN | FN | AN | FN | AN | FN | AN |
| 1 | 731616114003 | ANNAMALAI K | MECH | / | / | / | / | / | / | / | / | / | / |
| 2 | 731616114004 | ARSHATH S | MECH | / | / | / | / | / | / | / | / | / | / |
| 3 | 731616114005 | ASWINKUMAR S | MECH | / | / | / | / | / | / | / | / | / | / |
| 4 | 731616114007 | BOOPATHI RAJA E | MECH | P | P | P | P | P | P | P | P | P | P |
| 5 | 731616114011 | DEEPAK R | MECH | / | / | / | / | / | / | / | / | / | / |
| 6 | 731616114013 | DHEVENDRAN E | MECH | / | / | / | / | / | / | P | P | P | P |
| 7 | 731616114015 | DINESH KUMAR C | MECH | / | / | / | / | / | / | / | / | / | / |
| 8 | 731616114017 | GOKULRAJ P | MECH | / | / | / | / | / | / | A | A | A | A |
| 9 | 731616114018 | GOPINATH G | MECH | / | / | / | / | / | / | / | / | / | / |
| 10 | 731616114019 | GOVINDASAMY A | MECH | / | / | / | / | / | A | P | P | P | P |
| 11 | 731616114022 | HARIHARAN M | MECH | / | / | / | / | / | / | / | / | / | / |
| 12 | 731616114025 | INBARASAN C | MECH | / | / | / | / | / | / | / | / | / | / |
| 13 | 731616114028 | JEEVA K | MECH | / | / | / | / | / | / | / | / | / | / |
| 14 | 731616114029 | JEEVA M | MECH | / | / | / | / | / | / | / | / | A | A |
| 15 | 731616114030 | JESTINRAJ K | MECH | / | / | / | / | / | / | / | / | / | / |
| 16 | 731616114031 | JOSHUA Y | MECH | P | P | / | / | / | / | / | / | / | / |
| 17 | 731616114032 | KALEESWARAN D | MECH | P | P | P | P | P | P | / | / | / | / |
| 18 | 731616114033 | KAROLE INFANTO D | MECH | / | / | / | / | / | / | / | / | / | / |
| 19 | 731616114034 | KARTHIKEYAN P | MECH | / | / | / | / | / | / | / | / | / | / |
| 20 | 731616114035 | KAVIN P | MECH | A | A | A | A | / | / | A | A | / | / |
| 21 | 731616114038 | KESAV GOUTHAM N B | MECH | P | P | P | P | P | P | P | P | P | P |
| 22 | 731616114040 | KIRUBAKARAN M | MECH | / | / | / | / | P | P | / | / | / | / |
| 23 | 731616114042 | LOGESH N | MECH | / | A | / | / | / | / | A | A | A | A |
| 24 | 731616114045 | MAGESWARAN A | MECH | / | / | / | P | / | / | / | P | / | / |
| 25 | 731616114046 | MANIKANDAN V | MECH | / | / | A | A | / | / | A | A | A | A |
| 26 | 731616114047 | MANOJKUMAR K | MECH | / | / | P | P | / | / | / | P | P | P |
| 27 | 731616114048 | MOHAMMED NIHAL R | MECH | / | / | / | P | / | / | / | / | / | / |
| 28 | 731616114049 | MOHANAKRISHNAN D | MECH | / | / | / | / | / | / | / | / | / | / |
| 29 | 731616114050 | MOHAN ARJUN KUMARAVEL | MECH | / | / | / | / | / | / | / | / | / | / |
| 30 | 731616114051 | MOHANRAJ B | MECH | / | / | / | / | A | A | A | A | / | / |
| 31 | 731616114302 | BALAJI M | MECH | / | / | / | / | A | A | A | A | / | / |
| 32 | 731616114305 | JEEVANANDHAM N | MECH | A | A | / | / | / | / | / | / | P | P |
| 33 | 731616114306 | KARTHI S | MECH | A | A | / | / | / | / | / | / | / | / |
| PRESENT | | | | 26 | 25 | 27 | 27 | 27 | 27 | 22 | 22 | 23 | 22 |
| ABSENT | | | | 3 | 4 | 2 | 2 | 2 | 3 | 7 | 7 | 4 | 5 |
| PERMISSION | | | | 4 | 4 | 4 | 4 | 4 | 4 | 4 | 4 | 6 | 6 |

PRINCIPAL,
K. S. R. INSTITUTE FOR
ENGINEERING AND TECHNOLOGY,
K. S. R. KALVI NAGAR,
TIRUCHENGODE - 637 215,
NAMAKKAL DISTRICT, TAMIL NADU.

K S R INSTITUTE FOR ENGINEERING AND TECHNOLOGY, Tiruchengode

Training and Placement Cell

Batch 2 - Internal C Training Attendance for MECH (Odd Semester)

BATCH : 2016 - 2020

Academic Year: 2019 - 2020

| Date of Training Programme | | | 10.06.2019 | | 11.06.2019 | | 12.06.2019 | | 13.06.2019 | | 14.06.2019 | |
|----------------------------|--------------|-------------------------------|------------|----|------------|----|------------|----|------------|----|------------|----|
| S. No | Reg No | Name | FN | AN | FN | AN | FN | AN | FN | AN | FN | AN |
| 1 | 731616114055 | PARTHASARATHY R | / | / | / | / | / | / | / | / | / | / |
| 2 | 731616114056 | PRABAKARAN S | / | / | / | / | / | / | / | / | / | / |
| 3 | 731616114057 | PRABHAKARAN M | P | P | P | P | P | P | P | P | P | P |
| 4 | 731616114058 | PRASANTH R | P | P | P | P | P | P | P | P | P | P |
| 5 | 731616114059 | PRAVEEN R (07.01.1999) | / | / | / | / | / | / | / | / | / | / |
| 6 | 731616114060 | PRAVEEN R (31.03.1999) | / | / | / | / | / | / | / | / | / | / |
| 7 | 731616114061 | PRAVEENKUMAR S | P | P | P | P | P | P | P | P | P | P |
| 8 | 731616114063 | RAGAVENDHAR S | P | P | P | P | P | P | P | P | P | P |
| 9 | 731616114064 | RAHUL C | P | P | P | P | P | P | P | P | P | P |
| 10 | 731616114065 | RAJKUMAR S | A | A | P | P | A | A | A | A | A | A |
| 11 | 731616114066 | RANJITH R | A | A | A | A | A | A | A | A | A | A |
| 12 | 731616114067 | RANJITH KUMAR R | P | P | P | P | P | P | P | P | P | P |
| 13 | 731616114068 | RANJITHKUMAR V | / | / | / | / | / | / | / | / | / | / |
| 14 | 731616114069 | RAVICHANDRAN S | A | A | / | / | / | / | / | / | / | / |
| 15 | 731616114070 | RIYAZ AHAMED S | / | / | / | / | / | / | / | / | / | / |
| 16 | 731616114071 | RUTHRANNAN B | P | P | P | P | P | P | P | P | P | P |
| 17 | 731616114072 | SABARISH R(H) | / | / | / | / | / | / | / | / | / | / |
| 18 | 731616114073 | SAKTHI GNANASUNDARAM R H | / | / | / | / | / | / | / | / | / | / |
| 19 | 731616114074 | SAKTHIVEL R | P | P | P | P | P | P | P | P | P | P |
| 20 | 731616114075 | SANJAY KUMAR S (18.06.1999) | / | / | / | / | / | / | / | / | / | / |
| 21 | 731616114076 | SANJAY KUMAR S K (21.04.1999) | / | / | / | / | / | / | / | / | / | / |
| 22 | 731616114077 | SANTHOSH KUMAR B | P | P | P | P | P | P | P | P | P | P |
| 23 | 731616114078 | SANTHOSH KUMAR V | P | P | P | P | P | P | P | P | P | P |
| 24 | 731616114079 | SARAN K | P | P | P | P | P | P | P | P | P | P |
| 25 | 731616114080 | SARANRAJ S | / | / | / | / | / | / | / | / | / | / |
| 26 | 731616114081 | SATHISH G | P | P | P | P | P | P | P | P | P | P |
| 27 | 731616114083 | SOWNDHAR A | / | / | / | / | / | / | / | / | / | / |
| 28 | 731616114085 | TAMILMUGILAN N | P | P | P | P | P | P | P | P | P | P |
| 29 | 731616114086 | THAMOTHARAN J | / | / | / | / | / | / | / | / | / | / |
| 30 | 731616114087 | THIRUMURUGAN V | / | / | / | / | / | / | / | / | / | / |
| 31 | 731616114088 | UTHAYA KUMAR M | A | A | / | / | / | / | / | / | / | / |
| 32 | 731616114090 | VASANTHAKUMAR P | / | / | / | / | / | / | / | / | / | / |
| 33 | 731616114091 | VELMURUGAN T | / | / | / | / | / | / | / | / | P | P |
| 34 | 731616114093 | VIGNESH V | / | / | / | / | / | / | / | / | / | / |
| 35 | 731616114094 | VIJAY ANAND G | / | / | / | / | / | / | / | / | / | / |
| 36 | 731616114095 | VIJAYARAGAVAN P | / | / | / | / | / | / | / | / | / | / |
| 37 | 731616114096 | VINOTHMANI M | / | / | / | / | / | / | / | / | / | / |

PRINCIPAL,
K. S. R. INSTITUTE FOR
ENGINEERING AND TECHNOLOGY,
K. S. R. KAMBI NAGAR,
TIRUCHENGODE - 637 215,
NAMAKKAL Dt, TAMIL NADU.

| Date of Training Programme | | | 10.06.2019 | | 11.06.2019 | | 12.06.2019 | | 13.06.2019 | | 14.06.2019 | |
|----------------------------|--------------|-------------------|------------|----|------------|----|------------|----|------------|----|------------|----|
| S. No | Reg No | Name | FN | AN | FN | AN | FN | AN | FN | AN | FN | AN |
| 38 | 731616114097 | VISHNU A | A | A | A | A | A | A | A | A | A | A |
| 39 | 731616114099 | YOGARAJ.G | / | / | / | / | / | / | / | / | / | / |
| 40 | 731616114100 | YOGESH T | / | / | / | / | / | / | / | / | / | / |
| 41 | 731616114307 | PRAKASH S | / | / | / | / | / | / | / | / | / | / |
| 42 | 731616114309 | SANJEEVI K P | / | / | / | / | / | / | / | / | / | / |
| 43 | 731616114310 | SHANMUGAMANIVEL D | A | A | P | P | P | P | P | P | P | P |
| 44 | 731616114311 | SURENDHAR J | P | P | P | P | P | P | P | P | P | P |
| 45 | 731616114701 | PRANESH R K | / | / | / | / | / | / | / | / | / | / |
| 46 | 731616114701 | MANOJ R | / | / | / | / | / | / | / | / | / | / |
| PRESENT | | | 28 | 28 | 30 | 30 | 30 | 30 | 30 | 30 | 29 | 29 |
| ABSENT | | | 5 | 5 | 1 | 1 | 2 | 2 | 2 | 2 | 2 | 2 |
| PERMISSION | | | 13 | 13 | 13 | 13 | 13 | 13 | 13 | 13 | 15 | 15 |

 PRINCIPAL,
 K. S. R. INSTITUTE FOR
 ENGINEERING AND TECHNOLOGY,
 K. S. R. KALVINAG,
 TIRUCHENGOODE-631002,
 NAMAKKAL DL, TAMIL NADU.

**K S R INSTITUTE FOR ENGINEERING AND TECHNOLOGY
TIRUCHENGODE - 637 215**

TRAINING PROGRAMME FEEDBACK FORM



Name of the Student: KANUP P Branch: MECH

Year / Sem:

1. Name of the Training: Internal C programming

2. Name of the Trainer: Nandha gopal

3. Students rating of Trainers :

| S. No. | Date | Subject | Rating (✓) | | | |
|--------|--------------------------|---------------------------|------------|-----------|------|---------|
| | | | Excellent | Very good | Good | Average |
| 1 | 10.6.19 to 14.6.19 | Internal C programming | ✓ | | | |

4. Two positive points about the programme: I gained more knowledge in this session

5. Suggestions for improvement:

Date: 14-6-19

Kanup P
Signature

**K S R INSTITUTE FOR ENGINEERING AND TECHNOLOGY
TIRUCHENGODE - 637 215**

TRAINING PROGRAMME FEEDBACK FORM



Name of the Student: Saran K Branch: Mech

Year / Sem:

1. Name of the Training: Internal C training

2. Name of the Trainer: Nandha gopal

3. Students rating of Trainers :

| S. No. | Date | Subject | Rating (✓) | | | |
|--------|--------------------------|---------------------------|------------|-----------|------|---------|
| | | | Excellent | Very good | Good | Average |
| 1 | 10.6.19 to 14.6.19 | Internal C programming | ✓ | | | |

4. Two positive points about the programme: Session was good.

5. Suggestions for improvement:

Date: 14/6/19

PRINCIPAL,
K. S. R. INSTITUTE FOR
ENGINEERING AND TECHNOLOGY,
K. S. P. NAGAR,
TIRUCHENGODE - 637 215,
TAMIL NADU.

Saran K
Signature

**K S R INSTITUTE FOR ENGINEERING AND TECHNOLOGY
TIRUCHENGODE - 637 215**

TRAINING PROGRAMME FEEDBACK FORM



Name of the Student: Jeewa.K Branch: Mech

Year / Sem:

1. Name of the Training : Internal C Programming

2. Name of the Trainer : Nandhagopal

3. Students rating of Trainers :

| S. No. | Date | Subject | Rating (√) | | | |
|--------|--|--------------------------------|------------|-----------|------|---------|
| | | | Excellent | Very good | Good | Average |
| 1 | <u>20/6/19</u> to <u>14/6/19</u> | <u>Internal c training</u> | ✓ | | | |

4. Two positive points about the programme:

programming session was good.

5. Suggestions for improvement:

Date: 14/6/19

Jeewa
Signature

**K S R INSTITUTE FOR ENGINEERING AND TECHNOLOGY
TIRUCHENGODE - 637 215**

TRAINING PROGRAMME FEEDBACK FORM



Name of the Student: JEWA.K Branch: MECH

Year / Sem:

1. Name of the Training : Internal c programming

2. Name of the Trainer : Nandhagopal

3. Students rating of Trainers :

| S. No. | Date | Subject | Rating (√) | | | |
|--------|--|--------------------------------|------------|-----------|------|---------|
| | | | Excellent | Very good | Good | Average |
| 1 | <u>14/6/19</u> to <u>20/6/19</u> | <u>Internal c training</u> | ✓ | | | |

4. Two positive points about the programme: The program was very useful

5. Suggestions for improvement:

Date: 14/6/19

PRINCIPAL,
K. S. R. INSTITUTE FOR
ENGINEERING AND TECHNOLOGY,
M. B. P. P. NAGAR,
TIRUCHENGODE - 637 215,
KANNIYALU DI, TAMIL NADU.

Jeewa
Signature

Ref: KSRIET/T&P/CIR/2019-20

Date: 21.06.2019

This is to inform that all the HoD's and Training and Placement coordinators that the External Technical C Training programme for IV year students (2016 -2020 Batch) for the academic year 2019 - 2020 (Odd Sem) is scheduled as given below. All the registered students should attend the Training Programme without fail. If any student skips this Training Programme he / she will not be permitted for any further Training Programme and campus recruitment process. Proper Dress Code is mandatory.

| S.NO | Mode of Training | Dates | Topics / Faculty | Students |
|------|------------------|--------------------------------|-------------------------------------|---------------------------------------|
| 1 | External | 24.06.2019 to 29.06.2019 | Programming in C Mr. Aasaithambi | CSE-7, IT - 10, ECE - 24 & EEE - 2 |

T&P OFFICER

T&P COORDINATOR

PRINCIPAL

Copy to:

1. All HoDs
2. Notice Board

PRINCIPAL,
K. S. R. INSTITUTE FOR
ENGINEERING AND TECHNOLOGY,
K. S. R. TOWN, TIRUCHENGODE,
TIRUCHENGODE - 637 215,
TAMIL NADU.

K S R INSTITUTE FOR ENGINEERING AND TECHNOLOGY, Tiruchengode

Training and Placement Cell

Batch - 2 External Technical Training Attendance (Odd Semester) by Aaron Technologies

TRAINER AASAI THAMBI AARON TECH

BATCH : 2016 - 2020

Academic Year: 2019 - 2020

| Date of Training Programme | | | | 24.06.2019 | | 25.06.2019 | | 26.0.2019 | | 27.06.2019 | | 28.06.2019 | | 29.06.2019 | |
|----------------------------|--------------|-------------------|--------|------------|----|------------|----|-----------|----|------------|----|------------|----|------------|----|
| S. No | Reg No | Name | Branch | FN | AN | FN | AN | FN | AN | FN | AN | FN | AN | FN | AN |
| 1 | 731616104005 | BARATH.K | CSE | / | / | / | / | / | / | A | / | / | / | / | / |
| 2 | 731616104011 | GOWTHAMAKUMARAN.P | CSE | / | / | / | / | / | / | / | / | / | / | / | / |
| 3 | 731616104018 | KAMALESH.M | CSE | / | / | / | / | / | / | / | / | / | / | / | / |
| 4 | 731616104026 | PAVITHIRAN.S | CSE | / | / | / | / | / | / | / | / | / | / | / | / |
| 5 | 731616104047 | VISVESWARAN.B | CSE | P | P | / | / | / | / | / | / | A | / | / | / |
| 6 | | SILPHA | CSE | / | / | / | / | / | / | / | / | / | / | / | / |
| 7 | 731616104045 | VENMATHI | CSE | / | / | / | / | / | / | / | / | / | / | / | / |
| 8 | 731616205006 | BOOPALAN G | IT | / | / | / | / | / | / | / | / | / | / | / | / |
| 9 | 731616205017 | KARKULAZHI S | IT | / | / | / | / | / | / | / | / | / | / | / | / |
| 10 | 731616205019 | KAUSALYA J | IT | / | / | / | / | / | / | / | / | / | / | / | / |
| 11 | 731616205020 | KIRUBAKARAN R | IT | / | / | / | / | / | / | A | A | / | / | / | / |
| 12 | 731616205024 | MOUNIKA S | IT | / | / | / | / | / | / | / | / | / | / | / | / |
| 13 | 731616205027 | PRATHAP KUMAR E | IT | / | / | / | / | / | / | / | / | A | / | / | / |
| 14 | 731616205033 | SATHAS R | IT | / | / | / | / | / | / | / | / | / | A | / | / |
| 15 | 731616205039 | SWETHA S | IT | / | / | / | / | / | / | / | / | / | / | / | / |
| 16 | 731616205003 | ARAVINDHK | IT | / | / | / | / | / | / | A | A | A | / | / | / |
| 17 | 731616205036 | SUDHARSAN | IT | / | / | / | / | / | / | A | A | A | / | / | / |
| 18 | 731616106006 | ANANTH N | ECE | P | P | / | / | / | / | / | / | / | / | / | / |
| 19 | 731616106013 | BHUVANESHWARI P | ECE | / | / | / | / | / | / | A | A | A | / | / | / |
| 20 | 731616106014 | BRAHADEESHWARAN M | ECE | / | / | / | / | / | / | / | A | / | / | / | / |
| 21 | 731616106015 | BRINDHA M | ECE | / | / | / | / | / | / | A | A | A | A | / | / |
| 22 | 731616106017 | DHARANI V | ECE | / | / | / | / | / | / | A | A | / | / | / | / |
| 23 | 731616106019 | DINESHKRISHNA S | ECE | / | / | / | / | / | / | A | A | / | / | / | / |
| 24 | 731616106021 | DURAIRAJ S | ECE | / | / | / | / | / | / | A | A | / | / | / | / |
| 25 | 731616106022 | ELANGO VAN V | ECE | / | / | / | / | / | / | A | A | / | / | / | / |
| 26 | 731616106024 | GOWTHAM M | ECE | / | / | / | / | / | / | A | A | / | / | / | / |
| 27 | 731616106029 | JAYASHRI M | ECE | / | / | / | / | / | / | A | A | / | / | / | / |
| 28 | 731616106031 | KANIMOZHI R | ECE | / | / | / | / | A | A | A | A | / | / | / | / |
| 29 | 731616106032 | KARTHIKEYAN S | ECE | A | A | A | A | A | A | A | A | A | A | A | A |
| 30 | 731616106033 | KARTHIKEYAN V | ECE | / | / | / | / | / | / | A | A | / | / | / | / |
| 31 | 731616106034 | KOKILA K | ECE | / | / | / | / | / | / | A | A | / | / | / | / |
| 32 | 731616106036 | LOGESH KUMAR K | ECE | / | / | / | / | / | / | / | / | / | / | / | / |
| 33 | 731616106040 | MEENA A | ECE | / | / | / | / | / | / | / | / | / | / | / | / |
| 34 | 731616106042 | MONIKA R | ECE | / | / | / | / | / | / | A | A | / | / | / | / |
| 35 | 731616106056 | PRIYANKA C | ECE | / | / | / | / | / | / | A | A | / | / | / | / |
| 36 | 731616106062 | SANTHIA G | ECE | / | / | / | / | / | / | A | A | / | / | / | / |

PRINCIPAL,
K. S. R. INSTITUTE FOR
ENGINEERING AND TECHNOLOGY,
K. S. R. SALM NAGAR,
TIRUCHENGODE - 637 215,
KANNIYAKAL DI, TAMIL NADU.

| Date of Training Programme | | | | 24.06.2019 | | 25.06.2019 | | 26.0.2019 | | 27.06.2019 | | 28.06.2019 | | 29.06.2019 | |
|----------------------------|--------------|----------------|--------|------------|----|------------|----|-----------|----|------------|----|------------|----|------------|----|
| S. No | Reg No | Name | Branch | FN | AN | FN | AN | FN | AN | FN | AN | FN | AN | FN | AN |
| 37 | 731616106079 | Suriya E | ECE | / | / | / | / | / | / | / | / | / | / | / | / |
| 38 | 731616106079 | THANGAVEL P | ECE | / | A | / | / | / | / | / | / | P | / | / | / |
| 39 | 731616106082 | Vignesh R | ECE | / | / | / | / | / | / | / | / | / | / | / | / |
| 40 | 731616106302 | E.NAVANANDHINI | ECE | / | / | / | / | / | / | A | A | / | / | / | / |
| 41 | | ABISHEK | ECE | / | / | / | / | / | / | A | A | / | / | / | / |
| 42 | 731616105304 | HARIHARAN.R | EEE | / | / | / | / | / | / | / | / | / | / | / | / |
| 43 | 731616105305 | KARTHIK | EEE | / | P | / | / | / | / | A | A | / | / | / | / |
| PRESENT | | | | 40 | 38 | 42 | 42 | 41 | 41 | 21 | 21 | 35 | 40 | 42 | 42 |
| ABSENT | | | | 1 | 2 | 1 | 1 | 2 | 2 | 22 | 22 | 7 | 3 | 1 | 1 |
| PERMISSION | | | | 2 | 3 | 0 | 0 | 0 | 0 | 0 | 0 | 1 | 0 | 0 | 0 |

PRINCIPAL.
K. S. R. INSTITUTE FOR
ENGINEERING AND TECHNOLOGY,
K. S. R. KALVI NAGAR,
TIRUCHENGODE-637 215,
NAMAKKAL Dt, TAMIL NADU.

**K S R INSTITUTE FOR ENGINEERING AND TECHNOLOGY
TIRUCHENGODE - 637 215**

TRAINING PROGRAMME FEEDBACK FORM



Name of the Student: Aravindh. K Branch: IT

Year / Sem: IV / VII

1. Name of the Training : Technical C Programming

2. Name of the Trainer : Mrs. Asanthambi

3. Students rating of Trainers :

| S. No. | Date | Subject | Rating (✓) | | | |
|--------|--------------------------|-------------------------|------------|-----------|------|---------|
| | | | Excellent | Very good | Good | Average |
| 1 | 24.6.19 to 29.6.19 | Technical C Programming | ✓ | | | |

4. Two positive points about the programme:

- * Understand all the Concepts
- * Interesting session

5. Suggestions for improvement:

Need notes & Resourse questions

Date: 29/6/19

K. Aravindh
Signature

**K S R INSTITUTE FOR ENGINEERING AND TECHNOLOGY
TIRUCHENGODE - 637 215**

TRAINING PROGRAMME FEEDBACK FORM



Name of the Student: Karthi. K Branch: EEE

Year / Sem: IV / VII

1. Name of the Training : Technical C programming

2. Name of the Trainer : Mrs. Asanthambi

3. Students rating of Trainers :

| S. No. | Date | Subject | Rating (✓) | | | |
|--------|--------------------------|-------------------------|------------|-----------|------|---------|
| | | | Excellent | Very good | Good | Average |
| 1 | 24/6/19 to 29/6/19 | Technical C Programming | | ✓ | | |

4. Two positive points about the programme:

- * Interesting session.

5. Suggestions for improvement:

Date: 29/6/19

PRINCIPAL,
K. S. R. INSTITUTE FOR
ENGINEERING AND TECHNOLOGY,
K. S. R. V. NAGAR,
TIRUCHENGODE - 637 215,
NAMAKKAL Dt, TAMIL NADU.

Karthi. K
Signature

**TCS Ninja Specific Training**

Ref: KSRIET/T&P/CIR/2019-20

Date: 01.07.2019

This is to inform that all the HoD's, Class Advisor and Training and Placement coordinators that we have planned Placement training for IV Year students topics on "TCS Ninja Specific Training" (2016 - 2020 batch) on from 03.07.2019 to 09.07.2019 at ECE Seminar Hall by By CPC Team, KSREI - CPC for the academic year 2019 - 2020 (Odd Sem). All the Registered students should attend the training without fail.

| S.NO | Date & Time | Eligible Students Count |
|------|-----------------------------|---------------------------------------|
| 1 | 03.07.2019 to 09.07.2019 | CSE - 4, ECE - 6, IT - 3 & EEE - 2 |

Y. John + B
T&P OFFICER

[Signature]
T&P COORDINATOR

[Signature]
PRINCIPAL

Copy to:

1. All HoDs
2. Notice Board

[Signature]
PRINCIPAL,
K. S. R. INSTITUTE FOR
ENGINEERING AND TECHNOLOGY,
K. S. R. HALY NAGAR,
TIRUCHENGODE - 637 215,
NAMAIGAL DI, TAMIL NADU.



K S R IET T&P <ksrietplacement@gmail.com>

Reg : TCS Ninja Specific Training - 2020 Batch

3 messages

KSR Educational Institutions - Placement <placement@ksrei.org>

Mon, Jul 1, 2019 at 6:56 PM

To: "ksrctplacement@gmail.com" <ksrctplacement@gmail.com>, "ksrceplacement@gmail.com" <ksrceplacement@gmail.com>, "ksrietplacement@gmail.com" <ksrietplacement@gmail.com>

Dear Team,

As discussed with you all.

Total Reg happened for TCS Ninja - 2020 batch

CT : 268

CE : 180

IET: 75

Only top 100 students will be trained ,please find below nos of each college.

CT : 51

CE : 34

IET : 15

Training duration : 10 days

Training date : 3th July till 10th July 2019 and 13th and 14th July after the training getting completed everyday students have to take 2 assessments till 19th July 2019.

Kindly would request to share the database of these students on or before 12 noon tomorrow.

Thanks & Regards

Gopinath Shubramani

Placement Officer

K.S.R Educational Institutions

Tiruchengode - 637215 | Namakkal (DT) | Tamil Nadu

Mob : 92808 08083 | 73582 68034

Email : ksreiplacement@gmail.com

URL : www.ksrei.org

KSRIET TRAINING AND PLACEMENT <ksrietplacement@gmail.com>

Tue, Jul 2, 2019 at 12:09 PM

To: KSR Educational Institutions - Placement <placement@ksrei.org>

Cc: IET Principal Sir <venkatesh.muthusamy@gmail.com>, drrnandakumar@gmail.com, DrKalaavathi Buvaneshwaran <kalabhuvanesh@gmail.com>, MeenakshiDevi Venkatesan <drpmeenakshidevi@gmail.com>, jeya_psg <jeya_psg@rediffmail.com>

Bcc: Dept Mails <ksrietcseplacement@gmail.com>, Dept Mails <ksrieteplacement@gmail.com>, ksrieteplacement <ksrieteplacement@gmail.com>, KSRIET IT <ksrietitplacement@gmail.com>

Dear Sir,

Herewith we have attached TCS Ninja - 2020 batch students (15 Nos) database for your kind reference. Kindly find the attachments. Please revert it if any queries.

<https://mail.google.com/mail/u/0?ik=4f78d20f09&view=pt&search=all&permthid=thread-f%3A1637862679493117784&simpl=msg-f%3A1637862679493117784&sr>

 PRINCIPAL,
 K. S. R. EDUCATIONAL INSTITUTIONS,
 ENGINEERING AND TECHNOLOGY,
 K. S. R. HALVI NAGAR,
 TIRUCHENGODE - 637 215,
 NAMAKKAL DT, TAMIL NADU.

K S R INSTITUTE FOR ENGINEERING AND TECHNOLOGY, Tiruchengode

Training and Placement Cell

TCS Ninja Specific Training (Odd Semester)

Training by KSREI

| BATCH : 2016 - 2020 | | | | Academic Year: 2019 - 2020 | | | | | | | |
|----------------------------|--------------|---------------------|--------|----------------------------|----|----------|----|----------|----|----------|----|
| Date of Training Programme | | | | 03.07.19 | | 04.07.19 | | 05.07.19 | | 06.07.19 | |
| S. No | Reg No | Name | Branch | FN | AN | FN | AN | FN | AN | FN | AN |
| 1 | 731616106023 | GOKULAKRISHNAN A | ECE | / | / | / | / | / | / | / | / |
| 2 | 731616106036 | LOGESH KUMAR K | ECE | / | / | / | / | / | / | / | / |
| 3 | 731616106042 | MONIKA R | ECE | / | / | / | / | / | / | / | / |
| 4 | 731616106060 | ROSHINI T | ECE | / | / | / | / | / | / | / | / |
| 5 | 731616106072 | SUMATHI R | ECE | / | / | / | / | / | / | / | / |
| 6 | 731616106084 | YOGESH S | ECE | / | / | / | / | / | / | / | / |
| 7 | 731616105007 | BHARATHI KANNAN M R | EEE | / | / | / | / | / | / | / | / |
| 8 | 731616105043 | SHANKAR NARAYAN.M | EEE | / | / | / | / | / | / | / | / |
| 9 | 731616205011 | HAKKEM M | IT | / | / | / | / | / | / | / | / |
| 10 | 731616205014 | JANANI M | IT | / | / | / | / | / | / | / | / |
| 11 | 731616205023 | MOHANRAJ S | IT | / | / | / | / | / | / | / | / |
| 12 | 731616104003 | ANISHA.N | CSE | / | / | / | / | / | / | / | / |
| 13 | 731616104027 | PRAVEEN KUMAR.M | CSE | / | / | / | / | / | / | / | / |
| 14 | 731616104040 | SWETHA.B | CSE | / | / | A | A | / | / | / | / |
| 15 | 731616104042 | VASU MITHA.R.S | CSE | / | / | / | / | / | / | / | / |
| PRESENT | | | | 15 | 15 | 14 | 14 | 15 | 15 | 15 | 15 |
| ABSENT | | | | 0 | 0 | 1 | 1 | 0 | 0 | 0 | 0 |
| PERMISSION | | | | 0 | 0 | 0 | 0 | 0 | 0 | 0 | 0 |

PRINCIPAL,
K. S. R. INSTITUTE FOR
ENGINEERING AND TECHNOLOGY,
K. S. R. KALVI NAGAR,
TIRUCHENGODE - 637 215,
KARAYKAL Dt, TAMIL NADU.

K S R INSTITUTE FOR ENGINEERING AND TECHNOLOGY, Tiruchengode

Training and Placement Cell

TCS Ninja Specific Training (Odd Semester)

Training by KSREI (CPC)

| BATCH : 2016 - 2020 | | | | Academic Year: 2019 - 2020 | | | | | |
|----------------------------|--------------|---------------------|--------|----------------------------|----|----------|----|----------|----|
| Date of Training Programme | | | | 07.07.19 | | 08.07.19 | | 09.07.19 | |
| S. No | Reg No | Name | Branch | FN | AN | FN | AN | FN | AN |
| 1 | 731616106012 | BHAVYASHREE S | ECE | / | / | / | / | / | / |
| 2 | 731616106036 | LOGESH KUMAR K | ECE | / | / | / | / | / | / |
| 3 | 731616106042 | MONIKA R | ECE | / | / | / | / | / | / |
| 4 | 731616106060 | ROSHINI T | ECE | / | / | / | / | / | / |
| 5 | 731616106072 | SUMATHI R | ECE | / | / | / | / | / | / |
| 6 | 731616106084 | YOGESH S | ECE | / | / | / | / | / | / |
| 7 | 731616105007 | BHARATHI KANNAN M R | EEE | / | / | / | / | / | / |
| 8 | 731616105043 | SHANKAR NARAYAN.M | EEE | / | / | / | / | / | / |
| 9 | 731616205011 | HAKKEM M | IT | / | / | / | / | / | / |
| 10 | 731616205014 | JANANI M | IT | / | / | / | / | / | / |
| 11 | 731616205023 | MOHANRAJ S | IT | / | / | / | / | / | / |
| 12 | 731616104003 | ANISHA.N | CSE | / | / | / | / | / | / |
| 13 | 731616104027 | PRAVEEN KUMAR.M | CSE | / | / | / | / | / | / |
| 14 | 731616104040 | SWETHA.B | CSE | / | / | / | / | / | / |
| 15 | 731616104042 | VASU MITHA.R.S | CSE | / | / | / | / | / | / |
| PRESENT | | | | 15 | 15 | 15 | 15 | 15 | 15 |
| ABSENT | | | | 0 | 0 | 0 | 0 | 0 | 0 |
| PERMISSION | | | | 0 | 0 | 0 | 0 | 0 | 0 |

PRINCIPAL,
K. S. R. INSTITUTE FOR
ENGINEERING AND TECHNOLOGY,
K. S. R. ROAD, TIRUCHENGODE,
TIRUCHENGODE - 637 215,
NAMAKKAL Dt, TAMIL NADU.

**K S R INSTITUTE FOR ENGINEERING AND TECHNOLOGY
TIRUCHENGODE - 637 215**

TRAINING PROGRAMME FEEDBACK FORM



Name of the Student: Gokulakrishnan A Branch: ECE

Year / Sem: IV / VII

1. Name of the Training: TCS Ninja Specific Training

2. Name of the Trainer: KSRIET Faculty

3. Students rating of Trainers:

| S. No. | Date | Subject | Rating (✓) | | | |
|--------|------------------------|------------------|------------|-----------|------|---------|
| | | | Excellent | Very good | Good | Average |
| 1 | 3-7-19 to 6/7/19 | Java programming | ✓ | | | |

4. Two positive points about the programme:

Practical session was good

5. Suggestions for improvement:

Need less theory class.

Date: 6/7/19

Gokulakrishnan A
Signature

**K S R INSTITUTE FOR ENGINEERING AND TECHNOLOGY
TIRUCHENGODE - 637 215**

TRAINING PROGRAMME FEEDBACK FORM



Name of the Student: S. Mohanraj Branch: IT

Year / Sem: IV / VII

1. Name of the Training: TCS Ninja Specific Training

2. Name of the Trainer: KSRIET

3. Students rating of Trainers:

| S. No. | Date | Subject | Rating (✓) | | | |
|--------|------------------------|------------------|------------|-----------|------|---------|
| | | | Excellent | Very good | Good | Average |
| 1 | 3-7-19 to 6-7-19 | Java Programming | ✓ | | | |

4. Two positive points about the programme:

Informative session

5. Suggestions for improvement:

Date: 6/7/19

S. Mohanraj
Signature

**K S R INSTITUTE FOR ENGINEERING AND TECHNOLOGY
TIRUCHENGODE - 637 215**

TRAINING PROGRAMME FEEDBACK FORM



Name of the Student: GOKULA KRISHNAN A

Branch: ECE

Year / Sem: IV / VII

1. Name of the Training : TCS MINDA SPECIFIC TRAINING

2. Name of the Trainer : KSRIET FACULTY

3. Students rating of Trainers :

| S. No. | Date | Subject | Rating (√) | | | |
|--------|---------------------|-----------------|------------|-----------|------|---------|
| | | | Excellent | Very good | Good | Average |
| 1 | 7.7.19 to 9.7.19 | JAVA PROGRAM | ✓ | | | |

4. Two positive points about the programme:

Applet Programming concept was very interesting

5. Suggestions for improvement:

Date: 9.7.19

Gokula K. A
Signature

**K S R INSTITUTE FOR ENGINEERING AND TECHNOLOGY
TIRUCHENGODE - 637 215**

TRAINING PROGRAMME FEEDBACK FORM



Name of the Student: Hakram M

Branch: IT

Year / Sem: IV / VII

1. Name of the Training : TCS MINDA SPECIFIC TRAINING

2. Name of the Trainer : KSRIET FACULTY

3. Students rating of Trainers :

| S. No. | Date | Subject | Rating (√) | | | |
|--------|---------------------|-----------------|------------|-----------|------|---------|
| | | | Excellent | Very good | Good | Average |
| 1 | 7.7.19 to 9/7/19 | Java Program | ✓ | | | |

4. Two positive points about the programme:

Practical session was good

5. Suggestions for improvement:

Date: 9/7/19

PRINCIPAL
K. S. R. INSTITUTE FOR
ENGINEERING AND TECHNOLOGY,
K. S. R. HILLS, P. O.,
TIRUCHENGODE - 637 215,
NAWAKKAL DI, TAMIL NADU.

Hakram
Signature

TRAINING AND PLACEMENT CELL



Technical Training Programme Schedule [2019 - 2020] ODD Semester

Ref: KSRIET/T&P/CIR/2019-20

Date: 21.07.2019

This is to inform that all the HoD's and Training and Placement coordinators that the Technical Java Training programme for IV year students (2016 -2020 Batch) for the academic year 2019 - 2020 (Odd Sem) is scheduled as given below. All the registered students should attend the Training Programme without fail. If any student skips this Training Programme he / she will not be permitted for any further Training Programme and campus recruitment process. Proper Dress Code is mandatory.

| S.NO | Dates | Topics / Resource Person | Students |
|------|--------------------------------|--|--------------------------------------|
| 1 | 21.07.2019 to 26.07.2019 | Programming in Java Mr. Aasaithambi | CSE-7, IT - 8, ECE - 24 & EEE - 2 |

[Signature]
T&P OFFICER

[Signature]
21/7/19
T&P COORDINATOR

[Signature]
21/7/19
PRINCIPAL

Copy to:

1. All HoDs
2. Notice Board

[Signature]
PRINCIPAL,
K. S. R. INSTITUTE FOR
ENGINEERING AND TECHNOLOGY,
K. S. R. NAGAR,
TIRUCHENGODE - 637 215,
NAMAKAL DI, TAMIL NADU.

K S R INSTITUTE FOR ENGINEERING AND TECHNOLOGY, Tiruchengode

Training and Placement Cell

Externa Technical Training Attendance (Odd Semester) by Aaron Technologies

TRAINER AASAI THAMBI AARON TECH

BATCH : 2016 - 2020

Academic Year: 2019 - 2020

| Date of Training Programme | | | | 21.07.2019 | | 22.07.2019 | | 23.07.2019 | | 24.07.2019 | | 25.07.2019 | | 26.07.2019 | |
|----------------------------|--------------|-------------------|--------|------------|----|------------|----|------------|----|------------|----|------------|----|------------|----|
| S. No | Reg No | Name | Branch | FN | AN | FN | AN | FN | AN | FN | AN | FN | AN | FN | AN |
| 1 | 731616104005 | BARATH.K | CSE | / | / | / | / | / | / | / | / | / | / | / | / |
| 2 | 731616104011 | GOWTHAMAKUMARAN.P | CSE | / | / | / | / | / | / | / | / | / | / | A | A |
| 3 | 731616104018 | KAMALESH.M | CSE | / | / | / | / | / | / | / | / | A | A | / | / |
| 4 | 731616104026 | PAVITHIRAN.S | CSE | / | / | / | / | / | / | / | / | / | / | / | / |
| 5 | 731616104047 | VISVESWARAN.B | CSE | / | / | / | / | / | / | / | / | / | / | / | / |
| 6 | | SILPHA | CSE | / | / | / | / | / | / | / | / | / | / | / | / |
| 7 | 731616104045 | VENMATHI | CSE | P | P | / | / | / | / | / | / | / | / | / | / |
| 8 | 731616205006 | BOOPALAN G | IT | / | / | / | / | / | / | / | / | / | / | / | / |
| 9 | 731616205017 | KARKULAZHI S | IT | / | / | / | / | / | / | / | / | / | / | / | / |
| 10 | 731616205019 | KAUSALYA J | IT | / | / | / | / | / | / | / | / | / | / | / | / |
| 11 | 731616205020 | KIRUBAKARAN R | IT | / | / | / | / | A | A | / | / | / | / | A | A |
| 12 | 731616205024 | MOUNIKA S | IT | / | / | / | / | / | / | / | / | / | / | / | / |
| 13 | 731616205027 | PRATHAP KUMAR E | IT | / | / | / | / | / | / | / | / | A | A | / | / |
| 14 | 731616205033 | SATHAS R | IT | / | / | / | / | / | / | / | / | / | / | / | / |
| 15 | 731616205039 | SWETHA S | IT | / | / | / | / | / | / | / | / | / | / | / | / |
| 16 | 731616106006 | ANANTH N | ECE | / | / | / | / | / | / | / | / | / | / | / | / |
| 17 | 731616106013 | BHUVANESHWARI P | ECE | / | / | / | / | / | / | / | / | / | / | / | / |
| 18 | 731616106014 | BRAHADEESHWARAN M | ECE | / | / | / | / | / | / | / | / | / | / | / | / |
| 19 | 731616106015 | BRINDHA M | ECE | / | / | / | / | / | / | / | / | / | / | / | / |
| 20 | 731616106017 | DHARANI V | ECE | / | / | / | / | / | / | / | / | / | / | / | / |
| 21 | 731616106019 | DINESHKRISHNA S | ECE | / | / | / | / | / | / | / | / | / | / | / | / |
| 22 | 731616106021 | DURAIRAJ S | ECE | / | / | / | / | / | / | / | / | / | / | A | A |
| 23 | 731616106022 | ELANGO VAN V | ECE | / | / | A | A | / | / | / | / | / | / | / | / |
| 24 | 731616106024 | GOWTHAM M | ECE | / | / | / | / | / | / | / | / | / | / | / | / |
| 25 | 731616106029 | JAYASHRI M | ECE | / | / | / | / | / | / | / | / | / | / | / | / |
| 26 | 731616106031 | KANIMOZHI R | ECE | / | / | / | / | / | / | / | / | / | / | / | / |
| 27 | 731616106032 | KARTHIKEYAN S | ECE | / | / | / | / | / | / | / | / | / | / | / | / |
| 28 | 731616106033 | KARTHIKEYAN V | ECE | / | / | / | / | / | / | / | / | / | / | / | / |
| 29 | 731616106034 | KOKILA K | ECE | / | / | / | / | / | / | / | / | / | / | / | / |
| 30 | 731616106036 | LOGESH KUMAR K | ECE | / | / | / | / | A | A | / | / | / | / | / | / |
| 31 | 731616106040 | MEENA A | ECE | / | / | / | / | P | P | / | / | / | / | / | / |
| 32 | 731616106042 | MONIKA R | ECE | / | / | / | / | / | / | / | / | / | / | / | / |
| 33 | 731616106056 | PRIYANKA C | ECE | / | / | / | / | / | / | / | / | / | / | / | / |
| 34 | 731616106062 | SANTHIA G | ECE | / | / | / | / | / | / | / | / | / | / | / | / |
| 35 | 731616106079 | Suriya E | ECE | A | A | / | / | / | / | / | / | / | / | / | / |
| 36 | 731616106079 | THANGAVEL P | ECE | / | / | / | / | / | / | / | / | / | / | / | / |

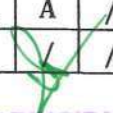
PRINCIPAL,
K S R INSTITUTE FOR
ENGINEERING AND TECHNOLOGY,
K S R, 1ST LAGAR,
TIRUCHENGODE - 637 215,
NAMAKKAL DL, TAMIL NADU.

| Date of Training Programme | | | | 21.07.2019 | | 22.07.2019 | | 23.07.2019 | | 24.07.2019 | | 25.07.2019 | | 26.07.2019 | |
|----------------------------|--------------|----------------|--------|------------|----|------------|----|------------|----|------------|----|------------|----|------------|----|
| S. No | Reg No | Name | Branch | FN | AN | FN | AN | FN | AN | FN | AN | FN | AN | FN | AN |
| 37 | 731616106082 | Vignesh R | ECE | / | / | / | / | / | / | / | / | / | / | A | A |
| 38 | 731616106302 | E.NAVANANDHINI | ECE | / | / | / | / | / | / | / | / | / | / | / | / |
| 39 | | ABISHEK | ECE | / | / | / | / | / | / | / | / | / | / | / | / |
| 40 | 731616105304 | HARIHARAN.R | EEE | / | / | / | / | / | / | / | / | A | A | / | / |
| 41 | 731616105305 | KARTHIK | EEE | / | / | / | / | / | / | / | / | / | / | / | / |
| PRESENT | | | | 39 | 39 | 40 | 40 | 38 | 38 | 41 | 41 | 38 | 38 | 37 | 37 |
| ABSENT | | | | 1 | 1 | 1 | 1 | 2 | 2 | 0 | 0 | 3 | 3 | 4 | 4 |
| PERMISSION | | | | 1 | 1 | 0 | 0 | 1 | 1 | 0 | 0 | 0 | 0 | 0 | 0 |

PRINCIPAL.
K. S. R. INSTITUTE FOR
ENGINEERING AND TECHNOLOGY,
K. S. R. KALVI NAGAR,
TIRUCHENGODE-637 215,
NAMAKKAL DI, TAMIL NADU.

**K S R INSTITUTE FOR ENGINEERING AND TECHNOLOGY
TIRUCHENGODE - 637 215**

TRAINING PROGRAMME FEEDBACK FORM



Name of the Student: Sathas R. Branch: IT

Year / Sem: IV/VII

1. Name of the Training: Technical Java Training

2. Name of the Trainer: Assai Thambi

3. Students rating of Trainers :

| S. No. | Date | Subject | Rating (✓) | | | |
|--------|--------------------------|---------------|------------|-----------|------|---------|
| | | | Excellent | Very good | Good | Average |
| 1 | 21.7.19 to 26.7.19 | Java Training | ✓ | | | |

4. Two positive points about the programme:

Good & Interesting Session

5. Suggestions for improvement:

Realtime session [Company model]

Date: 26/7/19

Signature

**K S R INSTITUTE FOR ENGINEERING AND TECHNOLOGY
TIRUCHENGODE - 637 215**

TRAINING PROGRAMME FEEDBACK FORM



Name of the Student: Parthran S. Branch: CSE

Year / Sem: IV/VII

1. Name of the Training: Technical Java training

2. Name of the Trainer: Assai Thambi

3. Students rating of Trainers :

| S. No. | Date | Subject | Rating (✓) | | | |
|--------|--------------------------|----------------|------------|-----------|------|---------|
| | | | Excellent | Very good | Good | Average |
| 1 | 21.7.19 to 26.7.19 | Java training. | ✓ | | | |

4. Two positive points about the programme:

Good and Interesting session.

5. Suggestions for improvement:

Company model training is needed.

Date: 26/7/19

Signature

TRAINING AND PLACEMENT CELL



Training Schedule [2019 - 2020] ODD Semester

Ref: KSRIET/T&P/CIR/2019-20

Date: 22.08.2019

This is to inform that all the HoD's and Training and Placement coordinators that the two days Java Training Programme planned for Final year students (2016 -2020 Batch) on 24.08.2019 and 25.08.2019 by Aasaithambi J, Aaron Technologies for the academic year 2019 - 2020 (Odd Sem) .All the registered students should attend the Training Programme without fail. If any student skips this Training Programme he / she will not be permitted for any further Training Programme and campus recruitment process. Proper Dress Code is mandatory.

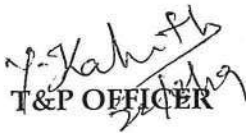
T&P OFFICER

T&P COORDINATOR

PRINCIPAL

Copy to:

1. All HoDs
2. Notice Board

PRINCIPAL,
K. S. R. INSTITUTE FOR
ENGINEERING AND TECHNOLOGY,
K. S. R. AVENUE,
TIRUCHENGODE - 637 215,
NAMAKKAL DI, TAMIL NADU.

K S R INSTITUTE FOR ENGINEERING AND TECHNOLOGY, Tiruchengode
Training and Placement Cell
Externa Technical Training Attendance (Odd Semester) by Aaron Technologies
TRAINER AASAI THAMBI AARON TECH

BATCH : 2016 - 2020

Academic Year: 2019 - 2020

| Date of Trainng Programme | | | | 24.08.2019 | | 25.08.2019 | |
|---------------------------|--------------|-------------------|--------|------------|----|------------|----|
| S. No | Reg No | Name | Branch | FN | AN | FN | AN |
| 1 | 731616104005 | BARATH.K | CSE | / | / | / | / |
| 2 | 731616104011 | GOWTHAMAKUMARAN.P | CSE | / | / | / | / |
| 3 | 731616104018 | KAMALESH.M | CSE | / | / | / | / |
| 4 | 731616104026 | PAVITHIRAN.S | CSE | / | / | / | / |
| 5 | 731616104047 | VISVESWARAN.B | CSE | / | / | / | / |
| 6 | | SILPHA | CSE | / | / | A | A |
| 7 | 731616104045 | VENMATHI | CSE | / | / | / | / |
| 8 | 731616205006 | BOOPALAN G | IT | / | / | / | / |
| 9 | 731616205017 | KARKULAZHI S | IT | / | / | / | / |
| 10 | 731616205019 | KAUSALYA J | IT | / | / | / | / |
| 11 | 731616205020 | KIRUBAKARAN R | IT | / | / | / | / |
| 12 | 731616205024 | MOUNIKA S | IT | A | A | / | / |
| 13 | 731616205027 | PRATHAP KUMAR E | IT | / | / | / | / |
| 14 | 731616205033 | SATHAS R | IT | / | / | / | / |
| 15 | 731616205039 | SWETHA S | IT | / | / | / | / |
| 16 | 731616106006 | ANANTH N | ECE | / | / | / | / |
| 17 | 731616106013 | BHUVANESHWARI P | ECE | / | / | / | / |
| 18 | 731616106014 | BRAHADEESHWARAN M | ECE | / | / | / | / |
| 19 | 731616106015 | BRINDHA M | ECE | / | / | / | / |
| 20 | 731616106017 | DHARANI V | ECE | / | / | / | / |
| 21 | 731616106019 | DINESHKRISHNA S | ECE | A | A | / | / |
| 22 | 731616106021 | DURAIRAJ S | ECE | / | / | / | / |
| 23 | 731616106022 | ELANGO VAN V | ECE | / | / | / | / |
| 24 | 731616106024 | GOWTHAM M | ECE | / | / | / | / |
| 25 | 731616106029 | JAYASHRI M | ECE | / | / | / | / |
| 26 | 731616106031 | KANIMOZHI R | ECE | / | / | / | / |
| 27 | 731616106032 | KARTHIKEYAN S | ECE | / | / | / | / |
| 28 | 731616106033 | KARTHIKEYAN V | ECE | / | / | / | / |
| 29 | 731616106034 | KOKILA K | ECE | / | / | / | / |
| 30 | 731616106036 | LOGESH KUMAR K | ECE | / | / | / | / |
| 31 | 731616106040 | MEENA A | ECE | / | / | / | / |
| 32 | 731616106042 | MONIKA R | ECE | / | / | / | / |
| 33 | 731616106056 | PRIYANKA C | ECE | / | / | / | / |
| 34 | 731616106062 | SANTHIA G | ECE | / | / | / | / |
| 35 | 731616106079 | Suriya E | ECE | / | / | / | / |
| 36 | 731616106079 | THANGAVEL P | ECE | / | / | / | / |
| 37 | 731616106082 | Vignesh R | ECE | A | A | / | / |

PRINCIPAL,
K. S. R. INSTITUTE FOR
ENGINEERING AND TECHNOLOGY,
K. S. R. KALVI NAGAR,
TIRUCHENGODE - 637 215,
NANAIGAL Dt, TAMIL NADU.

| Date of Trainng Programme | | | | 24.08.2019 | | 25.08.2019 | |
|---------------------------|--------------|----------------|--------|------------|----|------------|----|
| S. No | Reg No | Name | Branch | FN | AN | FN | AN |
| 38 | 731616106302 | E.NAVANANDHINI | ECE | / | / | / | / |
| 39 | | ABISHEK | ECE | / | / | / | / |
| 40 | 731616105304 | HARIHARAN.R | EEE | / | / | / | / |
| 41 | 731616105305 | KARTHI.K | EEE | / | / | / | / |
| PRESENT | | | | 38 | 38 | 40 | 40 |
| ABSENT | | | | 3 | 3 | 1 | 1 |
| PERMISSION | | | | 0 | 0 | 0 | 0 |

PRINCIPAL,
K. S. R. INSTITUTE FOR
ENGINEERING AND TECHNOLOGY,
K. S. R. KALYAN NAGAR,
TIRUCHENGODE - 637 215,
NAMAKKAL DIST, TAMIL NADU.

K S R INSTITUTE FOR ENGINEERING AND TECHNOLOGY
TIRUCHENGODE - 637 215

TRAINING PROGRAMME FEEDBACK FORM



Name of the Student: Meena . A . Branch: ECB

Year / Sem: IV / VII

1. Name of the Training : Two days Java Training

2. Name of the Trainer : Aasanthambi

3. Students rating of Trainers :

| S. No. | Date | Subject | Rating (✓) | | | |
|--------|----------------------------------|----------------------|------------|-----------|------|---------|
| | | | Excellent | Very good | Good | Average |
| 1 | <u>24.8.19</u> <u>25.8.19</u> | <u>Java Training</u> | ✓ | | | |

4. Two positive points about the programme:

Good session, Knowledge Person

5. Suggestions for improvement:

Date: 25/8/19

Meena . A .
Signature

K S R INSTITUTE FOR ENGINEERING AND TECHNOLOGY
TIRUCHENGODE - 637 215

TRAINING PROGRAMME FEEDBACK FORM



Name of the Student: Kirubakaran R . Branch: IT

Year / Sem: IV / VII

1. Name of the Training : Two days Java Training

2. Name of the Trainer : Aasanthambi

3. Students rating of Trainers :

| S. No. | Date | Subject | Rating (✓) | | | |
|--------|--|----------------------|------------|-----------|------|---------|
| | | | Excellent | Very good | Good | Average |
| 1 | <u>24.8.19</u> <u>to</u> <u>25.8.19.</u> | <u>Java Training</u> | ✓ | | | |

4. Two positive points about the programme:

Practical session was good.

5. Suggestions for improvement:

need more training.

Date:

25/8/19

Kirubakaran
Signature

Technical & Communication Skills Training Programme Schedule

Ref: KSRIET/T&P/CIR/2019-20

Date: 30.08.2019

This is to inform that all the HoD's and Training and Placement coordinators that the Communication & Technical Skills Training Programme for IV year students (2016 -2020 Batch) for the academic year 2019 - 2020 (Odd Sem) is scheduled as given below. All the registered students should attend the Training Programme without fail. If any student skips this Training Programme he / she will not be permitted for any further Training Programme and campus recruitment process. Proper Dress Code is mandatory.

| S.NO | Resource Persons | Dates | Topics | Students |
|------|---------------------------------------|--------------------------------|---|--|
| 1 | Mr Vinish, Match Point | 02.09.2019 To 06.09.2019 | External Wipro Specific Communication Skill Training | ECE- 16, EEE - 15, IT - 2, MECH - 6 & CSE - 5 Total - 44 |
| 2 | Mr. Aasai J Aaron Technologies, | 03.09.2019 To 06.09.2019 | Programming in Java | ECE- 23, EEE - 2, IT - 9 & CSE - 7 Total - 41 |

Y. J. Kishore
26/8/19
T&P OFFICER

[Signature]
30/8/19
T&P COORDINATOR

[Signature]
30/8/19
PRINCIPAL

Copy to:

1. All HoDs
2. Notice Board

PRINCIPAL,
K. S. R. INSTITUTE FOR
ENGINEERING AND TECHNOLOGY,
K. S. R. NAGAR,
TIRUCHENGODE - 637 215,
NAMAKKAL DT, TAMIL NADU.

K S R INSTITUTE FOR ENGINEERING AND TECHNOLOGY, Tiruchengode

Training and Placement Cell

External Java Technical Training Attendance (Odd Semester)

Trainers: Mr. Asai ThambiAaron Technologies

| BATCH : 2016 - 2020 | | | | Academic Year: 2019 - 2020 | | | | | | | |
|----------------------------|--------------|-------------------|--------|----------------------------|----|----------|----|----------|----|----------|----|
| Date of Training Programme | | | | 03.09.19 | | 04.09.19 | | 05.09.19 | | 06.09.19 | |
| S. No | Reg No | Name | Branch | FN | AN | FN | AN | FN | AN | FN | AN |
| 1 | 731616106002 | ABISHEK T | ECE | / | / | / | A | / | / | / | / |
| 2 | 731616106006 | ANANTH N | ECE | / | / | / | / | / | / | / | / |
| 3 | 731616106013 | BHUVANESHWARI P | ECE | / | / | / | / | / | / | / | / |
| 4 | 731616106014 | BRAHADEESHWARAN M | ECE | P | P | / | / | / | / | / | / |
| 5 | 731616106015 | BRINDHA M | ECE | / | / | / | / | / | / | / | / |
| 6 | 731616106017 | DHARANI V | ECE | / | / | / | / | / | / | / | / |
| 7 | 731616106019 | DINESHKRISHNA S | ECE | / | / | A | A | / | / | / | / |
| 8 | 731616106021 | DURAIRAJ S | ECE | / | / | / | / | / | / | / | / |
| 9 | 731616106022 | ELANGO VAN V | ECE | A | A | / | A | / | / | / | / |
| 10 | 731616106024 | GOWTHAM M | ECE | / | / | / | / | / | / | / | / |
| 11 | 731616106029 | JAYASHRI M | ECE | / | / | / | / | / | / | / | / |
| 12 | 731616106031 | KANIMOZHI R | ECE | / | / | / | / | / | / | / | / |
| 13 | 731616106032 | KARTHIKEYAN S | ECE | / | / | / | / | / | / | / | / |
| 14 | 731616106033 | KARTHIKEYAN V | ECE | / | / | / | / | / | / | / | / |
| 15 | 731616106034 | KOKILA K | ECE | / | / | / | / | / | / | / | / |
| 16 | 731616106036 | LOGESH KUMAR K | ECE | / | / | / | / | / | / | / | / |
| 17 | 731616106040 | MEENA A | ECE | / | / | / | / | / | / | / | / |
| 18 | 731616106042 | MONIKA R | ECE | / | / | / | / | / | / | / | / |
| 19 | 731616106302 | E.NAVANANDHINI | ECE | / | / | / | / | / | / | / | / |
| 20 | 731616106056 | PRIYANKA C | ECE | / | / | / | / | / | / | / | / |
| 21 | 731616106062 | SANTHIA G | ECE | / | / | A | A | A | A | A | A |
| 22 | 731616106079 | THANGAVEL P | ECE | / | / | / | / | / | A | / | / |
| 23 | 731616106082 | VIGNESH R | ECE | / | / | / | / | / | A | / | / |
| 24 | 731616105304 | HARIHARAN.R | EEE | / | / | / | / | / | / | / | / |
| 25 | 731616105305 | KARTHIK | EEE | / | / | / | / | / | / | / | / |
| 26 | 731616205003 | ARAVINDH K | IT | A | A | / | / | / | A | A | A |
| 27 | 731616205006 | BOOPALAN G | IT | / | / | / | / | / | / | / | / |
| 28 | 731616205017 | KARKULAZHI S | IT | / | / | / | / | / | / | / | / |
| 29 | 731616205019 | KAUSALYA J | IT | / | / | / | / | / | / | / | / |
| 30 | 731616205020 | KIRUBAKARAN R | IT | A | A | A | A | A | A | A | A |
| 31 | 731616205024 | MOUNIKA S | IT | / | / | / | / | / | / | / | / |
| 32 | 731616205027 | PRATHAP KUMAR E | IT | / | / | / | / | / | / | A | A |
| 33 | 731616205033 | SATHAS R | IT | / | A | A | A | A | A | A | A |
| 34 | 731616205039 | SWETHA S | IT | / | / | / | / | / | / | / | / |

PRINCIPAL,
K. S. R. INSTITUTE FOR
ENGINEERING AND TECHNOLOGY,
K. S. R. P. O., 13th JAR,
TIRUCHENGODE - 637 215,
NAMAKKAL DISTRICT, TAMIL NADU.

| Date of Training Programme | | | | 03.09.19 | | 04.09.19 | | 05.09.19 | | 06.09.19 | |
|----------------------------|--------------|-------------------|--------|----------|----|----------|----|----------|----|----------|----|
| S. No | Reg No | Name | Branch | FN | AN | FN | AN | FN | AN | FN | AN |
| 35 | 731616104005 | BARATH.K | CSE | NT | NT | NT | NT | NT | NT | NT | NT |
| 36 | 731616104011 | GOWTHAMAKUMARAN.P | CSE | NT | NT | NT | NT | NT | NT | NT | NT |
| 37 | 731616104018 | KAMALESH.M | CSE | NT | NT | NT | NT | NT | NT | NT | NT |
| 38 | 731616104026 | PAVITHIRAN.S | CSE | NT | NT | NT | NT | NT | NT | NT | NT |
| 39 | 731616104035 | SHILPA.B | CSE | NT | NT | NT | NT | NT | NT | NT | NT |
| 40 | 731616104045 | VENMATHI.S | CSE | NT | NT | NT | NT | NT | NT | NT | NT |
| 41 | 731616104047 | VISVESWARAN.B | CSE | NT | NT | NT | NT | NT | NT | NT | NT |
| PRESENT | | | | 30 | 29 | 30 | 28 | 31 | 28 | 29 | 29 |
| ABSENT | | | | 3 | 4 | 4 | 6 | 3 | 6 | 5 | 5 |
| PERMISSION | | | | 1 | 1 | 0 | 0 | 0 | 0 | 0 | 0 |

PRINCIPAL.
K. S. R. INSTITUTE FOR
ENGINEERING AND TECHNOLOGY,
K. S. R. KALVI NAGAR,
TIRUCHENGODE-637 215,
NAMAKKAL Dt, TAMIL NADU.

**K S R INSTITUTE FOR ENGINEERING AND TECHNOLOGY
TIRUCHENGODE - 637 215**

TRAINING PROGRAMME FEEDBACK FORM



Name of the Student: Kamalesh. M Branch: CSE

Year / Sem: IV / VII

1. Name of the Training: External Java Training

2. Name of the Trainer: Mr. Vinish

3. Students rating of Trainers :

| S. No. | Date | Subject | Rating (✓) | | | |
|--------|------------------------|---------------------------|------------|-----------|------|---------|
| | | | Excellent | Very good | Good | Average |
| 1 | 8.9.19 to 6.9.19 | External Java Training | ✓ | | | |

4. Two positive points about the programme:

* Interesting Session

5. Suggestions for improvement:

Date: 6/9/19

Kamalesh. M
Signature

**K S R INSTITUTE FOR ENGINEERING AND TECHNOLOGY
TIRUCHENGODE - 637 215**

TRAINING PROGRAMME FEEDBACK FORM



Name of the Student: Kausalya. J Branch: IT

Year / Sem: IV / VII

1. Name of the Training: External Java Technical Training

2. Name of the Trainer: Mr. Vinish

3. Students rating of Trainers :

| S. No. | Date | Subject | Rating (✓) | | | |
|--------|---------------------|-------------------------------------|------------|-----------|------|---------|
| | | | Excellent | Very good | Good | Average |
| 1 | 3.9.19 to 6.9.19 | External Java Technical training | ✓ | | | |

4. Two positive points about the programme:

Jdk concepts was very nice

5. Suggestions for improvement:

Need some videos for doing Applet programs

Date: 6.9.19

Kausalya. J
Signature

K S R INSTITUTE FOR
ENGINEERING AND TECHNOLOGY,
TIRUCHENGODE - 637 215,
TAMIL NADU.



This is to inform that all the HoD's, Class Advisor and Training and Placement coordinators that the Technical Skills Training programme is planned for II & III Year Students for the academic year 2019 - 2020 (Even Sem). All the Placement IT Sector registered students should attend the Training Programme without fail as per the schedule attached. Proper Dress Code is mandatory.

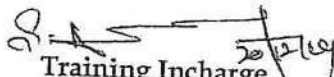

Training Incharge

T&P Coordinator

Principal

Copy to:

1. All HoDs
2. Notice Board

PRINCIPAL,
K. S. R. INSTITUTE FOR
ENGINEERING AND TECHNOLOGY,
K. S. R. KALEPALLEGAR,
TIRUCHENGODE - 637 215,
NAMAKKAL DISTRICT, TAMIL NADU.

TRAINING PLAN For 2019-2020 (Even)

Year / Sem : III / VI

Btatch 2017-2021

| S.No | Topic | Department | No. Of Days | Resource Person |
|------|----------------------------|-------------------------|----------------------|----------------------|
| 1 | Full Stack Development | IT-Placement Interested | Through out Semester | Internal & CPTC Team |
| 2 | Value Added Course -Python | IT-Placement Interested | 3 | Internal & CPTC Team |

Year / Sem : II / IV

Btatch 2018-2022

| S.No | Topic | Department | No. Of Days | Resource Person |
|------|---------------------------|-----------------|-------------|----------------------|
| 1 | Java | CSE & IT | 3 | Internal |
| 2 | Python | EEE ,ECE & MECH | 3 | Internal & CPTC Team |
| 3 | Value Added Course - DBMS | Circuit Branch | 3 | Internal |

Year / Sem : I / II

Btatch 2019-2023

| S.No | Topic | Department | No. Of Days | Resource Person |
|------|---------------|----------------|-------------|----------------------|
| 1 | C Programming | CSE & IT | 3 | Internal |
| 2 | Python | EEE,ECE & MECH | 3 | Internal & CPTC Team |

20/12/19
Training Incharge

20/12/19
T & P Coordinator

20/12/19
Principal

PRINCIPAL,
K. S. R. INSTITUTE FOR
ENGINEERING AND TECHNOLOGY,
K. S. R. ROAD, TIRUCHENGODE,
TIRUCHENGODE - 637 215,
DISTRICT: TIRUCHENGODE, TAMIL NADU.

TRAINING AND PLACEMENT CELL
TRAINING PLAN For III Year Students

Academic Year : 2019 -2020

Batch :2017-202

| Full Stack Development | | | | |
|------------------------|--|-----------------------|-------------------------|---------------------------------|
| S.No | Topic | Batch - I CSE & IT | Batch - II ECE & EEE | Resurce Person |
| 1 | Introduction to Java Command Line arguments Enhanced for Loop & Arrays | 20-Dec-19 | 26-Dec-19 | Mr.S.Nandhagopal |
| 2 | Classes, Objects & Encapsulation | 21-Dec-19 | 31-Dec-19 | Mr.S.Nandhagopal |
| 3 | Inheritance, Abstract Class & Abstract Method | 2-Jan-20 | 4-Jan-20 | Mr.S.Nandhagopal |
| 4 | Interfaces & Packages | 3-Jan-20 | 10-Jan-20 | Mr.S.Nandhagopal |
| 5 | Exception Handling & IO Streams | 30-Jan-20 | 7-Feb-20 | Mr.S.Nandhagopal |
| 6 | Collections | 31-Jan-20 | 8-Feb-20 | CPTC Team |
| 7 | Multi Threading & JDBC | 20-Feb-20 | 21-Feb-20 | Mr.S.Nandhagopal |
| 8 | Data Structure and Algorithms | 22-Feb-20 & 27-Feb-20 | 28-Feb-20 & 29-Feb-20 | CPTC Team |
| 9 | HTML & CSS | 9-Mar-20 | 10-Mar-20 | Mr.S.Nandhagopal |
| 10 | Javascript | 11-Mar-20 | 11-Mar-20 | Mr.S.Nandhagopal & CPTC Team |
| 11 | Node JS | 12-Mar-20 | 13-Mar-20 | CPTC Team |
| 12 | React JS | 16-Mar-20 | 17-Mar-20 | CPTC Team |
| 13 | Servlet | 1-Apr-20 | 3-Apr-20 | CPTC Team |
| 14 | JSP | 2-Apr-20 | 4-Apr-20 | CPTC Team |

S. A. S. S. S.
 Training In-charge

M. S. S. S.
 T & P Coordinator

M. S. S. S.
 Principal

Training and Placement Cell

Internal Full Stack Development Training (Java) For CSE & IT

| BATCH : 2017 - 2021 | | Trainer: Mr. S. Nandhagopal AP/IT | | Sem: EVEN | | | | Academic Year: 2019 - 2020 | | | | | |
|----------------------------|--------------|-----------------------------------|--------|------------|----|------------|----|----------------------------|----|------------|----|------------|----|
| Date of Training Programme | | | | 02.01.2020 | | 03.01.2020 | | 05.01.2020 | | 12.01.2020 | | 13.01.2020 | |
| S. No | Reg No | Name | Branch | FN | AN | FN | AN | FN | AN | FN | AN | FN | AN |
| 1 | 731617104002 | AGILAN R | CSE | P | P | P | P | P | P | P | P | P | P |
| 2 | 731617104004 | ARUN KUMAR N | CSE | P | P | P | P | A | A | A | A | P | P |
| 3 | 731617104005 | BABU R | CSE | P | P | P | P | P | P | P | P | P | P |
| 4 | 731617104007 | CHOWMIYA S B | CSE | A | A | P | P | P | P | P | P | P | P |
| 5 | 731617104009 | DERIL CHARLESS K | CSE | P | P | P | P | P | P | P | P | P | P |
| 6 | 731617104012 | DINESHKUMAR K | CSE | P | P | P | P | P | P | P | P | P | P |
| 7 | 731617104014 | GAYATHRI M | CSE | P | P | P | P | P | P | P | P | P | P |
| 8 | 731617104015 | GAYATHRI M | CSE | P | P | P | P | P | P | P | P | P | P |
| 9 | 731617104016 | GOWTHAM G | CSE | P | P | P | P | A | A | P | P | P | P |
| | 731617104020 | HARISH P | CSE | P | P | A | A | P | P | P | P | P | P |
| 11 | 731617104021 | KAILASH K | CSE | P | P | P | P | P | P | P | P | P | P |
| 12 | 731617104024 | KISHOR P | CSE | P | P | P | P | P | P | P | P | P | P |
| 13 | 731617104025 | KOTEESHWARAN P N | CSE | P | P | P | P | P | P | P | P | P | P |
| 14 | 731617104026 | KRISHNAMOORTHY S | CSE | P | P | P | P | P | P | P | P | P | P |
| 15 | 731617104028 | MARIMUTHU R | CSE | P | P | P | P | P | P | P | P | P | P |
| 16 | 731617104034 | POOJA M | CSE | P | P | P | P | P | P | P | P | P | P |
| 17 | 731617104035 | POOJA SHREE K | CSE | P | P | P | P | P | P | P | P | P | P |
| 18 | 731617104037 | PRAKASH V | CSE | P | P | A | A | P | P | P | P | P | P |
| 19 | 731617104039 | PRASANTH T | CSE | P | P | P | P | P | P | P | P | P | P |
| 20 | 731617104042 | SANGEETHA M | CSE | P | P | P | P | A | A | A | A | P | P |
| 21 | 731617104043 | SANTHOSHKUMAR | CSE | P | P | P | P | P | P | P | P | P | P |
| | 731617104045 | SHARMILA A | CSE | P | P | P | P | P | P | P | P | P | P |
| 23 | 731617104046 | SNEHA P | CSE | P | P | A | A | P | P | P | P | P | P |
| 24 | 731617104050 | VAISHNAVI V | CSE | P | P | P | P | P | P | P | P | P | P |
| 25 | 731617104051 | VALENTEENA COLLINS J P | CSE | P | P | P | P | P | P | P | P | P | P |
| 26 | 731617104052 | VEERALAKSHMI S | CSE | P | P | P | P | P | P | P | P | P | P |
| 27 | 731617104054 | VIGNESH S | CSE | P | P | P | P | P | P | P | P | P | P |
| 28 | 731617104058 | YUVASHREE R | CSE | P | P | P | P | P | P | P | P | P | P |
| 29 | 731617104013 | ELANGO M | CSE | P | P | P | P | P | P | P | P | P | P |
| 30 | 731617104017 | GUNA M | CSE | P | P | P | P | P | P | P | P | P | P |
| 31 | 731617104701 | MADHAN KUMAR | CSE | P | P | P | P | P | P | P | P | P | P |
| 32 | 731617104702 | DEEPAK J | CSE | A | A | P | P | P | P | P | P | P | P |
| 33 | 731617104023 | KESAVAN S | CSE | P | P | P | P | P | P | P | P | P | P |

K. S. R. INSTITUTE FOR ENGINEERING AND TECHNOLOGY,
TIRUCHENGODE - 621 015,
NAMAKKAL DISTRICT, TAMIL NADU.

| S. No | Reg No | Name | Branch | FN | AN | FN | AN | FN | AN | FN | AN | FN | AN |
|-------------------|--------------|----------------------|--------|----|----|----|----|----|----|----|----|----|----|
| 34 | 731617205002 | ARUL MOZHI M | IT | P | P | P | P | P | P | P | P | P | P |
| 35 | 731617205003 | BABU U S | IT | P | P | A | A | P | P | P | P | P | P |
| 36 | 731617205004 | BALAMURUGAN S | IT | P | P | P | P | P | P | P | P | P | P |
| 37 | 731617205011 | GOBIKA M | IT | P | P | P | P | P | P | P | P | P | P |
| 38 | 731617205013 | HARI PRASATH K | IT | P | P | P | P | P | P | P | P | P | P |
| 39 | 731617205014 | JESSICA COLLINS | IT | P | P | A | A | P | P | P | P | P | P |
| 40 | 731617205019 | KANNAN P | IT | P | P | P | P | P | P | P | P | P | P |
| 41 | 731617205025 | LAKSHMANAN R | IT | A | A | P | P | P | P | P | P | P | P |
| 42 | 731617205026 | MANIKANDAN A | IT | P | P | P | P | P | P | P | P | P | P |
| 43 | 731617205027 | MOUNISH G | IT | P | P | P | P | P | P | P | P | P | P |
| 44 | 731617205030 | NANDHINI S | IT | P | P | P | P | P | P | P | P | P | P |
| 45 | 731617205031 | NATHIYA V | IT | P | P | P | P | P | P | P | P | P | P |
| 46 | 731617205033 | NAVEENKUMAR G | IT | P | P | P | P | P | P | P | P | P | P |
| 47 | 731617205035 | PAVITHRA S | IT | P | P | A | A | P | P | P | P | P | P |
| 48 | 731617205036 | PRIYADHARSHINI P | IT | P | P | P | P | P | P | P | P | P | P |
| 49 | 731617205039 | SAANTHOSH BALAJI S N | IT | P | P | P | P | P | P | P | P | P | P |
| 50 | 731617205040 | SANDHIYA G | IT | P | P | P | P | A | A | P | P | P | P |
| 51 | 731617205041 | SANTHOSH KUMAR R | IT | P | P | P | P | P | P | P | P | P | P |
| 52 | 731617205042 | SARAN V | IT | P | P | P | P | P | P | P | P | P | P |
| 53 | 731617205044 | SATHISHKUMAR V | IT | P | P | P | P | P | P | P | P | P | P |
| 54 | 731617205045 | SELVAMALAR P | IT | P | P | P | P | P | P | P | P | P | P |
| 55 | 731617205046 | SHAILAA P M | IT | P | P | P | P | P | P | P | P | P | P |
| 56 | 731617205047 | SHIVANI N | IT | P | P | P | P | P | P | P | P | P | P |
| 57 | 731617205048 | SIVASANKARI R | IT | A | A | P | P | P | P | P | P | P | P |
| 58 | 731617205049 | SREEMATHI INDRA S | IT | P | P | P | P | P | P | P | P | P | P |
| 59 | 731617205051 | THANEESWARAN Y G | IT | P | P | P | P | P | P | P | P | P | P |
| 50 | 731617205052 | THUSMEENA K R | IT | P | P | A | A | P | P | P | P | P | P |
| 61 | 731617205053 | VENKATESWARAN S | IT | P | P | P | P | P | P | P | P | P | P |
| 62 | 731617205055 | VINOTHINI R | IT | P | P | P | P | P | P | P | P | P | P |
| PRESENT | | | | 58 | 58 | 55 | 55 | 58 | 58 | 60 | 60 | 62 | 62 |
| ABSENT | | | | 0 | 4 | 7 | 7 | 4 | 4 | 2 | 2 | 0 | 0 |
| PERMISSION | | | | 0 | 0 | 0 | 0 | 0 | 0 | 0 | 0 | 0 | 0 |

PRINCIPAL
 K. S. R. INSTITUTE FOR
 ENGINEERING AND TECHNOLOGY,
 K. S. R. KALUJIBAGAL,
 CHENGODE - 637 215,
 NARAYAL DI, TAMIL NADU.

Training and Placement Cell

Internal Full Stack Development Training (Java) for ECE & EEE

| BATCH : 2017 - 2021 | | Trainer: Mr. S. Nandhagopal AP/IT | | Sem: EVEN | | | | Academic Year: 2019 - 2020 | | | | | |
|----------------------------|--------------|-----------------------------------|--------|------------|----|------------|----|----------------------------|----|------------|----|------------|----|
| Date of Training Programme | | | | 04.01.2020 | | 05.01.2020 | | 10.01.2020 | | 12.01.2020 | | 13.01.2020 | |
| S. No | Reg No | Name | Branch | FN | AN | FN | AN | FN | AN | FN | AN | FN | AN |
| 1 | 731617105002 | ASHA R | EEE | P | P | P | P | P | P | P | P | P | P |
| 2 | 731617105052 | THAMIZHSELVAN R | EEE | P | P | P | P | P | P | A | A | P | P |
| 3 | 731617105013 | JEEVANANDAM T | EEE | P | P | P | P | P | P | P | P | P | P |
| 4 | 731617105024 | MOHAN T | EEE | A | A | P | P | P | P | P | P | P | P |
| 5 | 731617105010 | HARI S R | EEE | P | P | P | P | P | P | P | P | P | P |
| 6 | 731617105036 | SAKTHIVEL P | EEE | P | P | P | P | P | P | P | P | P | P |
| 7 | 731617105018 | KAVINKUMAR M | EEE | P | P | P | P | P | P | A | A | P | P |
| 8 | 731617105040 | SASIKUMAR C | EEE | P | P | P | P | P | P | P | P | P | P |
| 9 | 731617105008 | GOWTHAM S P | EEE | P | P | P | P | P | P | P | P | P | P |
| 10 | 731617105037 | SANTHOSHKUMAR K | EEE | P | P | A | A | P | P | P | P | P | P |
| 11 | 731617105027 | PARAMASIVAM R | EEE | P | P | P | P | P | P | P | P | P | P |
| 12 | 731617105016 | KAMALAHASAN G | EEE | P | P | P | P | P | P | A | A | P | P |
| 13 | 731617105022 | MANJUPRIYA M | EEE | A | A | P | P | P | P | P | P | P | P |
| 14 | 731617105034 | RAMYA A | EEE | P | P | P | P | P | P | P | P | P | P |
| 15 | 731617105019 | KAVIN MUTHU KUMAR S | EEE | P | P | P | P | P | P | P | P | P | P |
| 16 | 731617105044 | SHYAM PRASHAD S | EEE | P | P | P | P | P | P | A | A | P | P |
| 17 | 731617105005 | DINESH C | EEE | P | P | P | P | P | P | P | P | P | P |
| 18 | 731617105055 | VINOTH KUMAR R | EEE | P | P | P | P | A | A | A | A | A | A |
| 19 | 731617105031 | PRAVEEN KUMAR A | EEE | P | P | A | A | P | P | P | P | P | P |
| 20 | 731617105038 | SARANSARVESH M | EEE | P | P | P | P | P | P | P | P | P | P |
| 21 | 731617106003 | Alka P | ECE | A | A | P | P | P | P | P | P | P | P |
| 22 | 731617106006 | Balakumaran N | ECE | P | P | P | P | P | P | P | P | P | P |
| 23 | 731617106007 | Booma V | ECE | P | P | P | P | A | A | A | A | A | A |
| 24 | 731617106008 | Daranidaran R S | ECE | A | A | P | P | P | P | P | P | P | P |
| 25 | 731617106011 | Dhanushkodi N | ECE | P | P | P | P | P | P | P | P | P | P |
| 26 | 731617106015 | Dinnesh P | ECE | P | P | P | P | P | P | P | P | P | P |
| 27 | 731617106017 | Gokulnath N | ECE | P | P | P | P | P | P | P | P | P | P |
| 28 | 731617106019 | Gowtham M | ECE | P | P | P | P | P | P | P | P | P | P |
| 29 | 731617106020 | Hari Hara Sudhan R | ECE | P | P | P | P | P | P | P | P | P | P |
| 30 | 731617106021 | Harikrishnan M | ECE | P | P | A | A | P | P | P | P | P | P |
| 31 | 731617106023 | Hemaharini S | ECE | P | P | P | P | P | P | P | P | P | P |
| 32 | 731617106025 | Janarth S | ECE | P | P | P | P | P | P | P | P | P | P |
| 33 | 731617106027 | Jawahar Raja P | ECE | P | P | P | P | P | P | P | P | P | P |

K. S. R. ENGINEERING COLLEGE FOR
TIRUCHENGODE - 637 215,
NAMAKKAL Dt, TAMIL NADU.

| S.No | Reg No | Name | Branch | FN | AN | FN | AN | FN | AN | FN | AN | FN | AN |
|----------------|--------------|-------------------|--------|----|----|----|----|----|----|----|----|----|----|
| 34 | 731617106028 | Kamaleshwaran R | ECE | P | P | P | P | P | P | P | P | P | P |
| 35 | 731617106029 | Kamalini N | ECE | P | P | P | P | P | P | P | P | P | P |
| 36 | 731617106030 | Karthika C | ECE | P | P | P | P | P | P | P | P | P | P |
| 37 | 731617106031 | Keerthana S | ECE | P | P | P | P | P | P | P | P | P | P |
| 38 | 731617106033 | Kishor M | ECE | P | P | P | P | P | P | P | P | P | P |
| 39 | 731617106034 | Kishore D | ECE | P | P | P | P | P | P | P | P | P | P |
| 40 | 731617106036 | Madhangopal C | ECE | P | P | P | P | P | P | P | P | P | P |
| 41 | 731617106037 | Manimala R | ECE | P | P | P | P | P | P | P | P | P | P |
| 42 | 731617106038 | Manjula T | ECE | A | A | P | P | P | P | P | P | P | P |
| 43 | 731617106039 | Merin Kumar L | ECE | P | P | P | P | P | P | P | P | P | P |
| 44 | 731617106041 | Muthulakshmi S | ECE | P | P | P | P | P | P | P | P | P | P |
| 45 | 731617106045 | Parkavi P | ECE | P | P | P | P | P | P | P | P | P | P |
| 46 | 731617106046 | Parkavi S | ECE | P | P | A | A | P | P | P | P | P | P |
| 47 | 731617106048 | Premela R | ECE | P | P | P | P | P | P | P | P | P | P |
| 48 | 731617106050 | Priyanka V | ECE | P | P | P | P | P | P | P | P | P | P |
| 49 | 731617106055 | Ruban Prasad J | ECE | P | P | P | P | P | P | P | P | P | P |
| 50 | 731617106058 | Santhiya Y | ECE | P | P | P | P | P | P | P | P | P | P |
| 51 | 731617106061 | Shanmathi M M | ECE | P | P | P | P | P | P | P | P | P | P |
| 52 | 731617106068 | Sridharan M | ECE | P | P | P | P | P | P | P | P | P | P |
| 53 | 731617106069 | Srinivasan A | ECE | P | P | P | P | P | P | P | P | P | P |
| 54 | 731617106070 | Srinivasan S R | ECE | P | P | P | P | A | A | A | A | A | A |
| 55 | 731617106071 | Sri Ranjani S | ECE | P | P | P | P | P | P | P | P | P | P |
| 56 | 731617106073 | Subash K | ECE | P | P | P | P | P | P | P | P | P | P |
| 57 | 731617106077 | Suryapriya K | ECE | P | P | P | P | P | P | P | P | P | P |
| 58 | 731617106079 | Sweetlin Joshva A | ECE | P | P | P | P | P | P | P | P | P | P |
| 59 | 731617106080 | Swetha G P | ECE | OD | OD | P | P | P | P | P | P | P | P |
| 60 | 731617106081 | Tamilzhagan G | ECE | P | P | P | P | P | P | P | P | A | A |
| 61 | 731617106082 | Tejaswini S | ECE | P | P | P | P | P | P | P | P | P | P |
| 62 | 731617106084 | Thiyagu M | ECE | P | P | P | P | P | P | P | P | P | P |
| 63 | 731617106086 | Yasodha P | ECE | P | P | P | P | P | P | P | P | P | P |
| 64 | 731617106087 | Yuvansankar K | ECE | P | P | A | A | P | P | P | P | P | P |
| PRESENT | | | | 58 | 58 | 59 | 59 | 61 | 61 | 57 | 57 | 60 | 60 |
| ABSENT | | | | 5 | 5 | 5 | 5 | 3 | 3 | 7 | 7 | 4 | 4 |
| OD | | | | 1 | 1 | 0 | 0 | 0 | 0 | 0 | 0 | 0 | 0 |

K S R INSTITUTE FOR ENGINEERING AND TECHNOLOGY
TIRUCHENGODE - 637 215

TRAINING PROGRAMME FEEDBACK FORM



Name of the Student: Babu - R Branch: CSE

Year / Sem: IV / VI

1. Name of the Training: Full stack Development Training (Java)

2. Name of the Trainer: Ms. S. Nandhagopal

3. Students rating of Trainers :

| S. No. | Date | Subject | Rating (✓) | | | |
|--------|-----------------------------|--|------------|-----------|------|---------|
| | | | Excellent | Very good | Good | Average |
| 1 | 2.1.2020 to 13.1.2020 | Full stack Development Training (Java) | ✓ | | | |

4. Two positive points about the programme:

Java program was every easy to understand

5. Suggestions for improvement:

Need some JDK Software

Date: 13.1.2020

R. Babu
Signature

K S R INSTITUTE FOR ENGINEERING AND TECHNOLOGY
TIRUCHENGODE - 637 215

TRAINING PROGRAMME FEEDBACK FORM



Name of the Student: Pooja. H. Branch: CSE

Year / Sem: IV / VI

1. Name of the Training: Full stack Development Training [Java]

2. Name of the Trainer: Mr. S. Nandhagopal

3. Students rating of Trainers :

| S. No. | Date | Subject | Rating (✓) | | | |
|--------|-------------------------|--------------------------------------|------------|-----------|------|---------|
| | | | Excellent | Very good | Good | Average |
| 1 | 2.1.20 to 13.1.20 | Full stack Development Java Training | ✓ | | | |

4. Two positive points about the programme:

Good Practices with Play time Inclusion

5. Suggestions for improvement:

Need Home works
Good Practices

Date: 13/1/20

PRINCIPAL,
K. S. R. INSTITUTE FOR
ENGINEERING AND TECHNOLOGY,
K. S. R. ICLU NAGAR,
TIRUCHENGODE - 637 215,
NARAKKAL DI, TAMIL NADU.

Pooja H.
Signature

Company Specific Training Programme

Ref: KSRIET/T&P/CIR/2019-20

Date: 05.01.2020

This is to inform that all the HoD's, Class Advisor and Training and Placement Coordinators that the Company Specific Technical Training programme is planned for III Year Students (2017- 2021 batch) by KSREI - CPC for the academic year 2019 - 2020 (Even Sem). All the registered students should attend the Training Programme without fail as per the schedule given below. Proper Dress Code is mandatory.

| S.NO | Date & Time | Topics | Students Count |
|------|-------------------------------|--|--------------------------------------|
| 1 | 08.01.2020 & 09.01.2020 | Virtusa Software Manual Testing | CSE - 7 & IT- 8 Total - 15 |
| 2 | 10.01.2020 & 12.01.2020 | C & Data Structure Training for Amazon shortlist students | CSE - 3, ECE-1 & IT - 1 Total - 5 |



T&P OFFICER



T&P COORDINATOR



PRINCIPAL

Copy to:

1. All HoDs
2. Notice Board



PRINCIPAL,
K. S. R. INSTITUTE FOR
ENGINEERING AND TECHNOLOGY,
K. S. R. KALU NAGAR,
TIRUCHENGODE - 637 215,
NAMAIKAL DI, TAMIL NADU.

K S R INSTITUTE FOR ENGINEERING AND TECHNOLOGY, Tiruchengode
Training and Placement Cell
Department of English
Virtusa Manual Testing by CPC Team

BATCH : 2017 - 2021

Academic Year: 2019 - 2020

| S. No | Name | Branch | 08.01.2020 | | 09.01.2020 | |
|----------------|-------------------|--------|------------|----|------------|----|
| | | | FN | AN | FN | AN |
| 1 | GOBIKA M | IT | / | / | / | / |
| 2 | JESSICA COLLINS | IT | / | / | / | / |
| 3 | LAKSHMANAN R | IT | / | / | / | / |
| 4 | MOUNISH G | IT | / | / | / | / |
| 5 | SANTHOSH KUMAR R | IT | / | / | / | / |
| 6 | SREEMATHI INDRA S | IT | / | / | / | / |
| 7 | THANEESWARAN Y G | IT | / | / | / | / |
| 8 | THUSMEENA K R | IT | / | / | / | / |
| 9 | POOJA SHREE K | CSE | / | / | / | / |
| 10 | VEERALAKSHMI S | CSE | / | / | / | / |
| 11 | SHARMILA A | CSE | / | / | / | / |
| 12 | SNEHA P | CSE | / | / | / | / |
| 13 | YUVASHREE R | CSE | / | / | / | / |
| 14 | Gowtham G | CSE | A | A | / | / |
| 15 | KOTEESHWARAN P N | CSE | / | / | / | / |
| PRESENT | | | 14 | 14 | 15 | 15 |
| ABSENT | | | 1 | 1 | 15 | 15 |

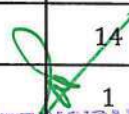
 PRINCIPAL
 K. S. R. INSTITUTE FOR
 ENGINEERING AND TECHNOLOGY,
 K. S. F. ROAD,
 TIRUCHENGODE - 613 215,
 NAMAKKAL DI, TAMIL NADU.

K S R INSTITUTE FOR ENGINEERING AND TECHNOLOGY, Tiruchengode
Training and Placement Cell

Technical C & Data Structure Training for Amazon Drive shortlist students

BATCH : 2017 - 2021

Academic Year: 2019 - 2020

| S. No | Reg No | Name | Branch | 10.01.2020 | | 11.01.2020 | | 12.01.2020 | |
|----------------|--------------|---------------|--------|------------|----|------------|----|------------|----|
| | | | | FN | AN | FN | AN | FN | AN |
| 1 | 731617104035 | POOJA SHREE K | CSE | / | / | / | / | / | / |
| 2 | 731617104045 | SHARMILA A | CSE | / | / | / | / | / | / |
| 3 | 731617104015 | GAYATHRI M | CSE | / | / | / | / | / | / |
| 4 | 731617106003 | ALKA P | ECE | / | / | / | / | / | / |
| 5 | 731617205040 | SANDHIYA G | IT | / | / | / | / | / | / |
| PRESENT | | | | 5 | 5 | 5 | 5 | 5 | 5 |
| ABSENT | | | | 0 | 0 | 0 | 0 | 0 | 0 |

 K. S. R. INSTITUTE FOR
 ENGINEERING AND TECHNOLOGY,
 K. S. R. INSTITUTE FOR
 TECHNICAL TRAINING,
 KASARAGODI, KERALA.

**K S R INSTITUTE FOR ENGINEERING AND TECHNOLOGY
TIRUCHENGODE - 637 215**

TRAINING PROGRAMME FEEDBACK FORM



Name of the Student: Sreemathi Indea S

Branch: IT

Year / Sem: III / VI

1. Name of the Training: Company specific Training Programme

2. Name of the Trainer: Ms. Sangeetha

3. Students rating of Trainers :

| S. No. | Date | Subject | Rating (✓) | | | |
|--------|-------------------------------|-----------------------------------|------------|-----------|------|---------|
| | | | Excellent | Very good | Good | Average |
| 1 | 08.01.2020 + 09.01.2020 | Company specific Training Program | | ✓ | | |

4. Two positive points about the programme:

I have learnt about the basic intellectual skills in this session

5. Suggestions for improvement:

Need some training classes

Date: 09.1.2020

Sreemathi S
Signature

**K S R INSTITUTE FOR ENGINEERING AND TECHNOLOGY
TIRUCHENGODE - 637 215**

TRAINING PROGRAMME FEEDBACK FORM



Name of the Student: Samhita Sri

Branch: IT

Year / Sem: IV / VI

1. Name of the Training: Amazon Shortlist

2. Name of the Trainer: Sangeetha

3. Students rating of Trainers :

| S. No. | Date | Subject | Rating (✓) | | | |
|--------|-------------------------|-----------------------|------------|-----------|------|---------|
| | | | Excellent | Very good | Good | Average |
| 1 | 10/11/20 to 12/11/20 | C and Data Structures | ✓ | | | |

4. Two positive points about the programme:

Session was good

5. Suggestions for improvement:

Date: 09/1/20

Sangeetha
Signature

TRAINING AND PLACEMENT CELL

Top Fresher's Technical Training Programme on C & Python Phase I

Ref: KSRIET/T&P/CIR/2019-20

Date: 14.02.2020

This is to inform that all the HoD's and Training and Placement coordinators that the C & Python Phase I Technical Training planned for III year Top Performed students (2017 -2021 Batch) for the academic year 2019 - 2020 (Even Sem) is scheduled as given below. All the registered students should attend the Training Programme without fail. If any student skips this Training Programme he / she will not be permitted for any further Training Programme and campus recruitment process. Proper Dress Code is mandatory.

| S.NO | Resource Persons | Dates | Topics | Students |
|------|------------------|--------------------------------|------------|--|
| 1 | Mr. Gopi Madhan | 17.02.2020 To 24.02.2020 | C & Python | CSE - 4, EEE-2, ECE-2, IT-4 & MECH - 2 Total - 14 |



 T&P OFFICER

 T&P COORDINATOR

 PRINCIPAL

Copy to:

1. All HoDs
2. Notice Board

 PRINCIPAL
 K. S. R. INSTITUTE FOR
 ENGINEERING AND TECHNOLOGY,
 K. S. R. INSTITUTE FOR
 TIRUCHENGODE - 637 215,
 NAMANGI, TIRUCHENGODE, TAMIL NADU.

K S R INSTITUTE FOR ENGINEERING AND TECHNOLOGY, Tiruchengode

Training and Placement Cell

Top Freshers Technical Training Programme by CPC - Students Name list

| BATCH : 2017 - 2021 | | | | Sem: EVEN | | | | | | | | Academic Year: 2019 - 2020 | | | | | | | |
|----------------------------|--------------|---------------------|--------|------------|----|------------|----|------------|----|------------|----|----------------------------|----|------------|----|------------|----|------------|----|
| Date of Training Programme | | | | 17.02.2020 | | 18.02.2020 | | 19.02.2020 | | 20.02.2020 | | 21.02.2020 | | 22.02.2020 | | 23.02.2020 | | 24.02.2020 | |
| S. No | Reg No | Name | Branch | FN | AN | FN | AN | FN | AN | FN | AN | FN | AN | FN | AN | FN | AN | FN | AN |
| 1 | 731617114033 | Hariharan G | MECH | / | / | / | / | / | / | / | / | / | / | / | / | / | / | / | / |
| 2 | 731617104016 | Gowtham G | CSE | / | / | / | / | / | / | / | / | / | / | / | / | / | / | / | / |
| 3 | 731617105024 | mohan T | EEE | / | / | / | / | / | / | / | / | / | / | / | / | / | / | / | / |
| 4 | 731617205011 | gobika | IT | / | / | / | / | / | / | / | / | / | / | / | / | / | / | / | / |
| 5 | 731617205052 | Thusmeena K R | IT | / | / | / | / | / | / | / | / | / | / | / | / | / | / | / | / |
| 6 | 731617114010 | Balaji | MECH | / | / | / | / | / | / | / | / | / | / | / | / | / | / | / | / |
| 7 | 731617106017 | Gokulnath.N | ECE | / | / | / | / | / | / | / | / | / | / | / | / | / | / | / | / |
| 8 | 731617104052 | Veeralakshmi S | CSE | / | / | / | / | / | / | / | / | / | / | / | / | / | / | / | / |
| 9 | 731617104035 | Pooja Shree K | CSE | / | / | / | / | / | / | / | / | / | / | / | / | / | / | / | / |
| 10 | 731617106003 | Alka P | ECE | / | / | / | / | / | / | / | / | / | / | / | / | / | / | / | / |
| 11 | 731617104025 | KOTEESHWARAN P N | CSE | / | / | / | / | / | / | / | / | / | / | / | / | / | / | / | / |
| 12 | 731617205041 | Santhosh Kumar | IT | / | / | / | / | / | / | / | / | / | / | / | / | / | / | / | / |
| 13 | 731617105019 | Kavin Muthu Kumar S | EEE | / | / | / | / | / | / | / | / | / | / | / | / | / | / | / | / |
| 14 | 731617205051 | Thanesswaran YG | IT | / | / | / | / | / | / | / | / | / | / | / | / | / | / | / | / |

PRINCIPAL,
 K. S. R. INSTITUTE FOR
 ENGINEERING AND TECHNOLOGY,
 K. S. R. KALVI NAGAR,
 TIRUCHENGODE-637 215,
 NAMAKKAL Dt, TAMIL NADU.

| | | | | | | | |
|--------------|------------------|-----------|-----------|-----------|-----------|-----------|---|
| 731617104042 | M.Sangeetha | Excellent | Excellent | Excellent | Excellent | Excellent | I have more confidence in me |
| 731617104028 | MARIMUTHU R | Excellent | Excellent | Excellent | Excellent | Excellent | It is too interactive workshop |
| 731617105024 | Mohan T | Good | Good | Good | Good | Good | Some stage fear is reduced |
| 731617106011 | N.dhanushkodi | Good | Good | Excellent | Good | Good | To eliminate our fear |
| 731617114038 | N.jagatheshwaran | Excellent | Good | Excellent | Good | Good | Very useful for placement and regular life |
| 731617205030 | Nandhini.s | Excellent | Excellent | Excellent | Good | Excellent | It creates an awarness among us, It...makes...people...aware..of..interview |
| 731617106015 | P.Dinnesh | Excellent | Good | Excellent | Good | Excellent | Made me to come and speak voluntarily in front of the public |
| 731617205046 | P.m.shailaa | Excellent | Excellent | Excellent | Excellent | Excellent | I can take intiative |
| 731617105036 | P.sakthivel | Excellent | Excellent | Excellent | Excellent | Excellent | Stress managment I had learn |
| 731617105027 | Paramasivam R | Good | Good | Good | Good | Excellent | 1.This workshop is very useful to me by overcoming the stage fear. 2.It created the self confidence. |
| 731617104037 | Prakash V | Good | Excellent | Excellent | Good | Good | Extracted the potential in me to communicate with others |
| 731617104039 | Prasanth T | Excellent | Excellent | Excellent | Excellent | Excellent | Devolpe our communication |
| 731617114077 | Premraj | Excellent | Good | Good | Good | Good | It will help to improve the communication skills and help to motivated us. |
| 731617106031 | S Keerthana | Excellent | Excellent | Excellent | Excellent | Excellent | Practicing exercise rather than simply talking |
| 731617104007 | S.B CHOWMIYA | Excellent | Excellent | Excellent | Good | Excellent | It shows based on interview |
| 731617114081 | SABARINATHAN S | Excellent | Excellent | Excellent | Excellent | Excellent | Speaking slowly to make an every one understand |
| 731617205040 | Sandhiya G | Good | Excellent | Good | Excellent | Good | Can everyone know who they aren't |
| 17IETCSE043 | Santhoshkumar A | Excellent | Excellent | Excellent | Excellent | Excellent | |
| 731617105038 | Saransarvesh m | Excellent | Good | Excellent | Good | Excellent | |
| 731617205045 | Selvamalar p | Excellent | Excellent | Good | Excellent | Excellent | It useful for us to developed our communication skills |

| Register Number | Name of the Student | Content of the Entire Workshop | Activities | Approach and Delivery of the Resource Person | Learning Outcome | Effectiveness of the Two-Day Workshop | Advantages of the Workshop: |
|-----------------|---------------------|--------------------------------|------------|--|------------------|---------------------------------------|--|
| 731617205026 | A. Manikandan | Excellent | Good | Excellent | Good | Excellent | Learned many things |
| 731617114094 | A.sureshkumar | Excellent | Excellent | Excellent | Excellent | Good | Good |
| 731617105002 | Aasha.R | Excellent | Excellent | Good | Excellent | Good | Doing activities |
| 731617106003 | ALKA P | Excellent | Excellent | Excellent | Excellent | Excellent | It was so interactive and gave us more opportunity to talk |
| 731617104004 | Arunkumar | Good | Good | Good | Good | Good | I know what is my level in communication |
| 731617114018 | Chandru.s | Excellent | Excellent | Excellent | Excellent | Good | Good knowledge |
| 73161706008 | Daranidaran R S | Good | Good | Excellent | Good | Good | The workshop was excellent and made everyone learn something new In communication |
| 731617106019 | Gowtham.M | Excellent | Excellent | Excellent | Good | Good | I can go and speak without hesitation... |
| 731617106020 | HARI HARA SUDHAN R | Excellent | Excellent | Excellent | Excellent | Good | 2nd day on the workshop I Identified my biggest mistake which I made in my past. Definitely I will rectifier that. |
| 731617205013 | Hariprasath K | Good | Excellent | Good | Good | Excellent | This workshop is benefit for me because for improve your vocabulary,how speak in front of dice,how to convey message this session so these 2days really utilized |
| 731617106055 | J. Ruban Prasad | Excellent | Excellent | Excellent | Excellent | Excellent | I have improved my communication skill |
| 731617105013 | Jeevanandam T | Excellent | Excellent | Excellent | Good | Good | |
| 731617105016 | Kamalahasan G | Good | Good | Good | Good | Good | My communication has improved |
| 731617106028 | KAMALESHWARAN R | Good | Good | Excellent | Good | Good | Usefull in learning |
| 731617105019 | Kavin muthu kumar S | Good | Good | Good | Good | Good | Initiative |
| 731617114051 | KIRUBAKARAN. K | Excellent | Excellent | Excellent | Excellent | Excellent | It should useful to avoid stage fear, It is very useful workshop |
| 731617205002 | M.Arulmozhi | Excellent | Excellent | Excellent | Excellent | Excellent | The two day workshops was very good.we learn more about interview based questions. |

**K S R INSTITUTE FOR ENGINEERING AND TECHNOLOGY
TIRUCHENGODE - 637 215**

TRAINING PROGRAMME FEEDBACK FORM



Name of the Student: Thummeera P.R Branch: IT
Year / Sem: II / VI

1. Name of the Training: C & Python Phase - I

2. Name of the Trainer: Mr. Gopinathan

3. Students rating of Trainers :

| S. No. | Date | Subject | Rating (√) | | | |
|--------|------------|----------------------|------------|-----------|------|---------|
| | | | Excellent | Very good | Good | Average |
| 1 | 24.02.2020 | C & Python Phase - I | | ✓ | | |

4. Two positive points about the programme:

In this session, the difference of C & Python Phase was very interesting

5. Suggestions for improvement:

Date: 24.2.2020

Thummeera P.R
Signature

**K S R INSTITUTE FOR ENGINEERING AND TECHNOLOGY
TIRUCHENGODE - 637 215**

TRAINING PROGRAMME FEEDBACK FORM



Name of the Student: Gowtham G Branch: ESE
Year / Sem:

1. Name of the Training: C & Python phase - 2

2. Name of the Trainer: Mr. Gopinathan

3. Students rating of Trainers :

| S. No. | Date | Subject | Rating (√) | | | |
|--------|------------|----------------------|------------|-----------|------|---------|
| | | | Excellent | Very good | Good | Average |
| 1 | 24.02.2020 | C & Python Phase - 2 | | ✓ | | |

4. Two positive points about the programme:

5. Suggestions for improvement:

Date: 24.2.2020

PRINCIPAL
K. S. R. INSTITUTE FOR
ENGINEERING AND TECHNOLOGY,
K. S. R. KALVI NAGAR,
TIRUCHENGODE-637 215,
TAMIL NADU.

Gowtham G
Signature

TRAINING AND PLACEMENT CELL

Top Fresher's Technical Training Programme on C & Python Phase II

Ref: KSRIET/T&P/CIR/2019-20

Date: 27.02.2020

This is to inform that all the HoD's and Training and Placement coordinators that the C & Python Phase II Technical Training planned for III year Top Performed students (2017 -2021 Batch) for the academic year 2019 - 2020 (Even Sem) is scheduled as given below. All the registered students should attend the Training Programme without fail. If any student skips this Training Programme he / she will not be permitted for any further Training Programme and campus recruitment process. Proper Dress Code is mandatory.

| S.NO | Resource Persons | Dates | Topics | Students |
|------|------------------|--------------------------------|------------|-----------------------------------|
| 1 | Mr. Gopi Madhan | 02.03.2020 To 06.03.2020 | C & Python | CSE - 4, EEE-2, IT-3 Total - 9 |

 T&P OFFICER

 T&P COORDINATOR

 PRINCIPAL

Copy to:

1. All HoDs
2. Notice Board

 PRINCIPAL,
 K. S. R. INSTITUTE FOR
 ENGINEERING AND TECHNOLOGY,
 K. S. R. KALVIYUGAR,
 TIRUCHENGODE - 637 215,
 NAMAKKAL Dt, TAMIL NADU.

Phase II Top Freshers Technical Training Programme by CPC - Students Name list

| BATCH : 2017 - 2021 | | | | Sem: EVEN | | | | Academic Year: 2019 - 2020 | | | | | |
|----------------------------|--------------|---------------------|--------|------------|----|------------|----|----------------------------|----|------------|----|------------|----|
| Date of Training Programme | | | | 02.03.2020 | | 03.03.2020 | | 04.03.2020 | | 05.03.2020 | | 06.03.2020 | |
| S. No | Reg No | Name | Branch | FN | AN | FN | AN | FN | AN | FN | AN | FN | AN |
| 1 | 731617104016 | Gowtham G | CSE | / | / | / | / | / | / | / | / | / | / |
| 2 | 731617104025 | KOTEESHWARAN P N | CSE | / | / | / | / | / | / | / | / | / | / |
| 3 | 731617104052 | Veeralakshmi S | CSE | / | / | / | / | / | / | / | / | / | / |
| 4 | 731617104035 | Pooja Shree K | CSE | / | / | / | / | / | / | / | / | / | / |
| 5 | 731617105019 | Kavin Muthu Kumar S | EEE | / | / | / | / | / | / | / | / | / | / |
| 6 | 731617105024 | mohan T | EEE | / | / | / | / | / | / | / | / | / | / |
| 7 | 731617205011 | gobika | IT | / | / | / | / | / | / | / | / | / | / |
| 8 | 731617205041 | Santhosh Kumar | IT | / | / | / | / | / | / | / | / | / | / |
| 9 | 731617205051 | Thanesshwaran YG | IT | / | / | / | / | / | / | / | / | / | / |

PRINCIPAL,
K. S. R. INSTITUTE FOR
ENGINEERING AND TECHNOLOGY,
K. S. R. NAJAF NAGAR,
TIRUCHENGODE - 687 216,
NAMAKKAL DISTRICT, TAMIL NADU.

**K S R INSTITUTE FOR ENGINEERING AND TECHNOLOGY
TIRUCHENGODE - 637 215**

TRAINING PROGRAMME FEEDBACK FORM



Name of the Student: Veera Lakshmi S Branch: CSE

Year / Sem: III / VI

1. Name of the Training: C & Python Phase - II

2. Name of the Trainer: Mr. Gopimadhan

3. Students rating of Trainers :

| S. No. | Date | Subject | Rating (√) | | | |
|--------|--------|-----------------------|------------|-----------|------|---------|
| | | | Excellent | Very good | Good | Average |
| 1 | 6.3.20 | C & Python Phase - II | ✓ | | | |

4. Two positive points about the programme:

The session is good

5. Suggestions for improvement:

Date: 6.3.20

Veera Lakshmi S
Signature

**K S R INSTITUTE FOR ENGINEERING AND TECHNOLOGY
TIRUCHENGODE - 637 215**

TRAINING PROGRAMME FEEDBACK FORM



Name of the Student: Gowtham G Branch: IT

Year / Sem: III / VI

1. Name of the Training: C & Python phase - II

2. Name of the Trainer: Mr. Gopimadhan

3. Students rating of Trainers :

| S. No. | Date | Subject | Rating (√) | | | |
|--------|--------|-----------------------|------------|-----------|------|---------|
| | | | Excellent | Very good | Good | Average |
| 1 | 6.3.20 | C & Python phase - II | ✓ | | | |

4. Two positive points about the programme: This session was excellent

5. Suggestions for improvement:

Date: 6.3.20

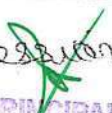
PRINCIPAL,
K. S. R. INSTITUTE FOR
ENGINEERING AND TECHNOLOGY,
K. S. R. ROAD, Gowtham
TIRUCHENGODE - 637 215, Signature
NARAYANAPURAM, TAMIL NADU.

TRAINING AND PLACEMENT CELL



Training Schedule [2019 - 2020] Even Semester

Ref: KSRIET/T&P/CIR/2019-20

Date: 14.04.2020

This is to inform that all the HoD's and Training and Placement coordinators that Virtual Mode Technical Java & Python Training programme is planned for II year students by Internal CSE & IT Faculty for the academic year 2019 - 2020 (Even Sem) is scheduled as given below.

| S.NO | Dates | Students | Topics | Name of the Faculty |
|------|--------------------------------|--|--|---|
| 1 | 20.04.2020 To 30.04.2020 | CSE -& IT | Introduction to Java, Command line Arguments, Enhanced For Loop & Arrays, Classes & Objects Encapsulation Inheritance Abstract Class & Methods, Interfaces Packages Exception Handling IO streams | Mr. R. Gopal AP/CSE |
| | | ECE - 32, EEE- 23 & MECH - 26 | Python Introduction List, List as array, Tuples Advanced List of Processing Command Line Arguments, Errors & Exception, Modules Classes & Objects Inheritance | Mr Venkatesh AP/ CSE & Ms. Sathyapriya AP/CSE |

[Signature]
T&P OFFICER

[Signature]
T&P COORDINATOR

[Signature]
PRINCIPAL

Copy to: 1. All HoDs 2. Notice Board

PRINCIPAL,
K. S. R. INSTITUTE FOR
ENGINEERING AND TECHNOLOGY,
K. S. R. COLLEGE LAGAR,
TIRUCHENGODE - 637 215,
MADHURAI DISTRICT, TAMIL NADU.

2018- 2022

Trainer Name: Mr. R. Gopal AP/IT

Topic - JAVA

| Reg No | Name | 20/4/20 | 21/4/20 | 22/4/20 | 23/4/20 | 24/4/20 | 25/4/20 | 27/4/20 | 28/4/20 | 29/4/20 | 30/4/20 |
|---------|-------------------------|---------|---------|---------|---------|---------|---------|---------|---------|---------|---------|
| 1 | AARTHI M | / | / | / | / | A | / | / | A | A | / |
| 2 | BALAJI S | / | / | / | / | / | A | / | / | / | A |
| 3 | BHUVANSHANKAR B | A | A | / | / | / | / | A | / | / | / |
| 4 | CHENNAKRISHNAN S | / | / | / | / | / | / | / | / | / | / |
| 5 | DHANUSHIYA V | / | / | A | / | / | / | / | / | / | / |
| 6 | GOKULAKRISHNAN B | / | / | / | / | / | / | / | / | / | / |
| 7 | GOWSALYA G | / | / | / | / | / | / | A | / | / | / |
| 8 | HARI BILGATES S | / | / | / | / | / | / | / | / | / | / |
| 9 | HEMALATHA DEVI P | / | / | / | / | / | A | / | / | / | A |
| 10 | ISHWARYA R | / | A | / | / | / | / | / | / | / | / |
| 11 | JAILLESH K | A | / | / | / | A | / | / | / | / | / |
| 12 | JAYAC KEERTHANA SK | / | / | / | / | / | / | / | / | / | / |
| 13 | JOTHIVEL D | / | / | / | A | / | A | / | / | / | / |
| 14 | KAMAL G | / | / | / | / | / | / | / | / | / | A |
| 15 | KAVIN M | A | / | / | / | / | / | / | / | / | / |
| 16 | KAVIYA S | / | / | / | / | A | / | / | / | A | / |
| 17 | KAVIYA PRIYADHARSHINI M | / | / | / | / | / | / | / | / | / | A |
| 18 | KIRUTHIKA S | / | / | A | / | / | / | / | / | / | / |
| 19 | MAHESH KUMAR K S | / | / | / | / | / | / | / | / | / | / |
| 20 | MUTHUSELVI A | / | / | / | / | / | / | / | / | / | A |
| 21 | NAVEEN A | / | / | / | A | / | / | / | / | / | / |
| 22 | POOVENDIRAN G | / | / | / | / | / | / | / | / | / | / |
| 23 | PRANESHKUMAR B | A | / | / | / | / | / | / | / | / | / |
| 24 | RAJKUMAR S | / | / | / | / | / | / | / | / | / | / |
| 25 | RESHMA R | / | / | / | / | / | / | / | / | A | / |
| 26 | SHARMILA R | / | / | A | / | / | / | / | / | / | / |
| 27 | SOUNDARYA C | A | / | / | / | / | / | / | / | / | A |
| 28 | SOUNDARYA G G | / | / | / | / | / | / | / | / | / | / |
| 29 | SRIJA M | / | / | / | / | / | / | / | / | / | / |
| 30 | SUBASH S | A | / | / | / | A | / | / | / | / | / |
| 31 | SUDERSAN A | / | / | / | / | / | / | / | / | / | A |
| 32 | SURENDRHIRAN S | / | / | / | / | / | / | / | / | / | / |
| 33 | SUSHMA R | / | / | A | / | / | / | / | / | / | / |
| 34 | VISHNU PRASAD A | / | / | / | / | / | A | / | / | A | / |
| 35 | YOGESH K | / | / | / | / | A | / | / | / | / | A |
| 36 | LOGESWARAN M | / | / | / | / | / | / | / | / | / | / |
| Present | | 30 | 34 | 32 | 34 | 31 | 32 | 34 | 35 | 32 | 2 |
| Absent | | 6 | 2 | 4 | 2 | 5 | 4 | 2 | 1 | 4 | 8 |

K. S. R. INSTITUTE FOR ENGINEERING AND TECHNOLOGY,
ENGINEERING COLLEGE,
K. S. R. INSTITUTE,
TIRUVANMIYUR - 627 215,
NAMAKKAL Dt, TAMIL NADU.

Training and Placement Cell

Virtua Mode Technical Training Attendance - ECE

Year: 2018- 2022

Academic Year:2019 - 2020

| Trainer Name: Mr. Venkatesh & Ms. Sathyapriya, AP/CSE | | Topic - Python | | | | | | | | | | |
|---|--------------|-------------------|-----------|-----------|-----------|-----------|-----------|-----------|-----------|-----------|-----------|-----------|
| No | Reg No | Name | 20/4/20 | 21/4/20 | 22/4/20 | 23/4/20 | 24/4/20 | 25/4/20 | 27/4/20 | 28/4/20 | 29/4/20 | 30/4/20 |
| 1 | 731618106001 | AAKASH J | A | A | A | A | A | A | A | A | A | A |
| 2 | 731618106002 | ACKSAR AHAMATHI I | / | / | A | A | A | A | A | A | A | A |
| 3 | 731618106003 | AMUTHA K | / | / | / | / | / | / | / | / | | / |
| 4 | 731618106004 | DEEPTHEE M | / | / | A | A | / | / | A | A | A | A |
| 5 | 731618106005 | DHAANU S | / | / | | / | / | / | / | / | | / |
| 6 | 731618106006 | DHARANI B | A | A | A | A | A | A | A | A | A | A |
| 7 | 731618106007 | DHIVIN RITHIK J | A | A | A | A | A | A | A | A | A | A |
| 8 | 731618106008 | GOKUL K | / | A | A | / | A | A | A | / | A | / |
| 9 | 731618106009 | HARI KRISHNAN D | A | A | A | A | / | A | A | A | A | A |
| 10 | 731618106010 | JANARTHANAN S | / | / | A | A | / | / | / | / | | / |
| 11 | 731618106011 | JOY PRINCY P | A | A | A | A | / | / | / | A | A | A |
| 12 | 731618106013 | KAMALRAJ A | A | A | A | A | | A | A | A | A | A |
| 13 | 731618106015 | KAVIN S | A | A | A | A | A | A | A | A | A | A |
| 14 | 731618106016 | KRISHNAN S | A | A | A | A | A | A | A | A | A | A |
| 15 | 731618106018 | NAVEENKUMAR N | A | / | A | A | A | A | / | A | A | / |
| 16 | 731618106019 | NITHYA M | / | / | / | / | / | / | / | A | A | A |
| 17 | 731618106020 | PAVITHRA M | / | / | | / | / | / | / | / | | A |
| 18 | 731618106022 | PRASANTH S | / | / | / | / | / | / | / | / | / | / |
| 19 | 731618106023 | RAGAVAN V | A | A | A | A | / | A | A | A | A | A |
| 20 | 731618106024 | RAGUL P | A | A | A | A | A | A | A | / | A | / |
| 21 | 731618106025 | RANJITH G | A | / | A | / | / | A | / | A | A | A |
| 22 | 731618106026 | SASI S | A | A | A | A | A | A | A | A | A | / |
| 23 | 731618106027 | SATHISHKUMAR M | / | / | A | A | / | / | / | / | / | A |
| 24 | 731618106028 | SATHYA R | / | / | A | / | / | / | / | / | A | A |
| 25 | 731618106029 | SETHUPATHI R | A | A | A | A | A | A | / | A | A | / |
| 26 | 731618106030 | SHALINI S | / | A | A | A | / | / | / | A | A | A |
| 27 | 731618106031 | SURIYA A | / | A | A | A | / | / | / | A | A | / |
| 28 | 731618106032 | THANGARAJ K | A | / | / | / | A | / | / | / | A | / |
| 29 | 731618106033 | THULASIRAMAN S | / | A | A | A | / | | / | A | A | A |
| 30 | 731618106034 | VAISHNAVI K | A | / | A | / | / | / | / | A | A | / |
| 31 | 731618106035 | YASODHA S | / | / | A | / | / | / | / | A | A | / |
| 32 | 731618106301 | MAHESH J | A | / | / | / | / | / | / | / | A | A |
| Present | | | 15 | 14 | 18 | 8 | 12 | 19 | 16 | 18 | 11 | 14 |
| Absent | | | 17 | 18 | 14 | 24 | 20 | 13 | 16 | 14 | 21 | 18 |

PRINCIPAL,
K. S. R. INSTITUTE FOR
ENGINEERING AND TECHNOLOGY,
K. S. R. MAIN ROAD,
TIRUCHENGODE - 637 215,
NAMAKKAL DISTRICT, TAMIL NADU.

Date: 2018-2022

Trainer Name: Mr. Venkatesh & Ms. Sathyapriya, AP/CSE

Topic - Python

| No | Reg No | Name | 20/4/20 | 21/4/20 | 22/4/20 | 23/4/20 | 24/4/20 | 25/4/20 | 27/4/20 | 28/4/20 | 29/4/20 | 30/4/20 |
|---------|------------|-------------------|---------|---------|---------|---------|---------|---------|---------|---------|---------|---------|
| 1 | IET18ME001 | ARIHARAN M | A | / | / | / | / | A | / | / | A | / |
| 2 | IET18ME002 | ARIVAZHAHAN R | / | / | A | / | A | / | / | / | / | A |
| 3 | IET18ME003 | ARULBHARATHI G V | / | / | A | A | / | / | / | A | / | / |
| 4 | IET18ME004 | ARUN PRAKASH K A | A | / | / | / | / | / | / | / | / | / |
| 5 | IET18ME005 | BOOBALAN S | / | / | / | / | / | / | / | / | A | / |
| 6 | IET18ME006 | CHANDRU K | A | / | / | / | A | / | / | / | / | / |
| 7 | IET18ME007 | DHANASEKAR D | / | / | / | / | / | / | / | / | / | / |
| 8 | IET18ME008 | DHARANEESHWARAN N | A | / | / | / | / | / | / | A | / | / |
| 9 | IET18ME009 | DHURAIRAJ K | / | / | / | / | A | / | / | / | / | / |
| 10 | IET18ME010 | GOPINATH S | / | / | A | A | / | / | / | / | / | / |
| 11 | IET18ME011 | GOWTHAM K | / | / | / | / | / | A | / | / | / | / |
| 12 | IET18ME012 | JAYAPRAKASH S | / | / | A | / | / | / | / | / | / | / |
| 13 | IET18ME013 | KARTHICK RAJA V | / | A | / | / | / | / | A | / | A | / |
| 14 | IET18ME014 | KAVIN S | A | / | A | / | / | / | / | / | / | / |
| 15 | IET18ME015 | KAVIN KUMAR S | / | / | / | A | / | / | A | / | / | / |
| 16 | IET18ME016 | KAVIRAJ G | A | / | / | / | / | / | / | / | / | A |
| 17 | IET18ME018 | KRISHNAKUMAR R | / | / | / | / | A | A | A | / | A | / |
| 18 | IET18ME017 | KRISHNAN S | / | / | A | / | / | / | / | / | / | / |
| 19 | IET18ME019 | MANIKANDAN P | / | / | / | / | / | / | / | A | / | / |
| 20 | IET18ME020 | MANIVASAGAM M | A | / | / | / | / | / | / | / | / | / |
| 21 | IET18ME021 | MONISHVARAN T | A | / | A | / | / | / | / | A | / | / |
| 22 | IET18ME022 | PRASANTH S | / | / | / | / | / | / | / | A | / | / |
| 23 | IET18ME023 | PRAVEEN M | / | / | / | / | / | / | / | / | / | / |
| 24 | IET18ME024 | RAJASEKAR S | / | A | / | / | / | A | / | / | / | / |
| 25 | IET18ME025 | RAMKUMAR S | A | / | / | / | / | / | / | / | / | / |
| 26 | IET18ME026 | SAMRAT G | / | / | / | / | / | / | A | / | / | / |
| 27 | IET18ME027 | SARAN.K | / | / | / | / | / | / | / | / | / | / |
| 28 | IET18ME028 | SELVARAJ K | A | / | A | / | / | / | A | / | / | A |
| 29 | IET18ME029 | SRIDHAR P | / | / | / | / | / | / | / | / | / | / |
| 30 | IET18ME030 | SRINATH S | / | / | / | / | / | / | / | / | A | / |
| 31 | IET18ME031 | SUDARSHAN R | A | / | A | / | / | / | / | / | / | / |
| 32 | IET18ME032 | VENKATESH P | / | A | / | / | / | / | / | A | / | / |
| 33 | IET18ME033 | VIGNESH G | / | / | / | / | / | / | / | / | A | / |
| 34 | IET18ME034 | VIJAY S | A | / | / | / | / | / | / | / | / | A |
| 35 | IET18ME035 | VIKRAM S | / | / | A | A | / | / | A | / | / | / |
| 36 | IET18ME036 | YOGESH G | / | A | / | / | / | / | / | A | / | / |
| Present | | | 24 | 32 | 26 | 32 | 31 | 29 | 30 | 31 | 30 | 32 |
| Absent | | | 12 | 4 | 10 | 4 | 5 | 7 | 6 | 5 | 6 | 4 |

PRINCIPAL,
K. S. R. INSTITUTE FOR
ENGINEERING AND TECHNOLOGY,
K. S. R. COLONY NAGAR,
TIRUENELVELI - 637 215,
NAMAKKAL Dt, TAMIL NADU.

Training and Placment Cell

Virtua Mode Technical Training Attendance - EEE

Academic Year:2019 - 2020

Batch: 2018- 2022

Trainer Name: Mr. Venkatesh & Ms. Sathyapriya, AP/CSE

Topic - Python

| No | Reg No | Name | 20/4/20 | 21/4/20 | 22/4/20 | 23/4/20 | 24/4/20 | 25/4/20 | 27/4/20 | 28/4/20 | 29/4/20 | 30/4/20 |
|----------------|--------------|-------------------|---------|---------|---------|---------|---------|---------|---------|---------|---------|---------|
| 1 | 731618105001 | ARVIND KUMAR N | A | / | A | / | / | / | / | / | A | / |
| 2 | 731618105002 | BASKAR S | A | A | / | / | / | A | A | A | A | A |
| 3 | 731618105003 | BHARATHIPRIYAN K | A | A | A | / | A | A | A | A | / | |
| 4 | 731618105004 | DEENATHAYALAN G | A | / | / | / | / | A | / | / | A | / |
| 5 | 731618105005 | DHATCHANAMOORTHIA | A | A | A | / | A | / | / | A | / | |
| 6 | 731618105006 | GOKUL P | A | A | A | A | A | A | A | A | A | A |
| 7 | 731618105007 | GOKULRAJ P | / | / | / | / | / | / | / | / | / | / |
| 8 | 731618105008 | GOKULRAYAR R | A | A | A | A | A | A | A | A | A | A |
| | 731618105009 | HEMALATHA S | / | / | / | / | / | / | / | / | A | / |
| 10 | 731618105010 | JAMBUKESH I | A | / | / | A | / | A | / | A | / | A |
| 11 | 731618105011 | MEIYARASU K | A | A | A | A | A | A | / | A | / | A |
| 12 | 731618105012 | MONISA B | / | / | A | A | / | / | / | / | / | A |
| 13 | 731618105013 | MYTHREYAN J | A | | / | / | / | / | / | / | / | / |
| 14 | 731618105014 | NANDHAKUMAR J | A | A | A | A | A | A | A | A | A | A |
| 15 | 731618105015 | NAVEEN N | / | / | | / | / | / | / | / | | / |
| 16 | 731618105016 | SANKAR S | A | A | A | A | A | A | A | A | A | A |
| 17 | 731618105017 | SARATHI VASAN J | A | A | / | / | A | / | / | / | / | / |
| 18 | 731618105018 | SAVURIYAPPAN S | / | A | A | A | A | / | A | A | A | A |
| 19 | 731618105019 | SRIDHAR D | A | / | / | / | / | / | A | A | / | A |
| 20 | 731618105022 | VIJAY E | A | A | A | A | A | A | A | A | A | A |
| | 731618105301 | ATHIF. L | / | / | / | / | / | / | / | | / | / |
| 22 | 731618105302 | TAMILARASAN | A | A | A | / | A | A | / | / | A | A |
| | 731618105502 | PRASATH S | A | A | A | A | A | A | A | A | A | A |
| Present | | | 7 | 9 | 10 | 14 | 11 | 12 | 14 | 10 | 10 | 8 |
| Absent | | | 16 | 14 | 13 | 9 | 12 | 11 | 9 | 13 | 13 | 15 |

 PRINCIPAL
 K. S. R. INSTITUTE FOR
 ENGINEERING AND TECHNOLOGY,
 K. S. R. T. JAGAR,
 TRUCHERU - 637 215,
 NAIKAKKAL Dt, TAMIL NADU.

Date: 2018- 2022

Trainer Name: Mr. R. Gopal AP/IT

Topic - JAVA

| No | Reg No | Name | 20/4/20 | 21/4/20 | 22/4/20 | 23/4/20 | 24/4/20 | 25/4/20 | 27/4/20 | 28/4/20 | 29/4/20 | 30/4/20 |
|---------|-------------|-------------------------|---------|---------|---------|---------|---------|---------|---------|---------|---------|---------|
| 1 | 73161820500 | ADHITHIYABALA N | / | A | / | / | / | / | / | / | / | / |
| 2 | 73161820500 | ARAVINDH R | / | / | / | / | A | / | / | / | / | / |
| 3 | 73161820500 | ARAVINDHAN R | / | / | A | / | / | / | A | / | A | / |
| 4 | 73161820500 | DEETSHIDHAR L | / | / | / | / | / | / | / | A | / | / |
| 5 | 73161820500 | DEVESH K S | A | / | A | / | / | / | / | / | / | / |
| 6 | 73161820500 | GOWSIKA R | / | / | / | / | / | / | / | / | / | / |
| 7 | 73161820500 | HARIHARAN S | / | / | / | A | / | / | A | / | / | / |
| 8 | 73161820501 | HARINI V | / | / | / | / | / | / | / | / | A | / |
| 9 | 73161820501 | KANNAN DEVAN K | / | A | / | / | / | / | / | / | / | / |
| 10 | 73161820501 | KAVYADEVI V | / | / | A | / | / | / | / | / | / | A |
| 11 | 73161820501 | KISHORE M | / | / | / | / | A | / | / | / | / | / |
| 12 | 73161820501 | MANOJ M | A | / | / | / | / | / | / | / | / | / |
| 13 | 73161820501 | MOHANAPRASATH V | / | / | A | / | / | / | A | / | / | / |
| 14 | 73161820501 | MOULEESHWAR C P | / | / | / | / | / | / | / | / | / | / |
| 15 | 73161820501 | RAMYABHARATHI M | A | / | A | / | / | / | / | / | A | / |
| 16 | 73161820501 | MUTHUMAHESH K | / | / | / | / | / | / | / | / | / | / |
| 17 | 73161820502 | PRIYADHARSHINI B | / | / | A | / | / | / | A | / | / | / |
| 18 | 73161820502 | PRIYADHARSINI M | A | / | / | A | / | / | / | / | / | / |
| 19 | 73161820502 | RAJESWARI K | / | / | / | / | / | / | / | / | / | / |
| 20 | 73161820502 | RAJKUMAR V | / | / | / | A | / | / | / | / | / | A |
| 21 | 73161820502 | RESHMA G | / | / | / | / | / | / | / | / | / | / |
| 22 | 73161820502 | SANTHIYA K | / | / | / | / | / | A | / | / | / | / |
| 23 | 73161820503 | SATHIYAMOORTHI SR | / | / | / | / | / | / | / | / | / | / |
| 24 | 73161820503 | SELVA GANAPATHY S | / | / | A | / | / | / | / | / | A | / |
| 25 | 73161820503 | SENGOTTAIYAN G | / | / | / | A | / | / | / | / | / | / |
| 26 | 73161820503 | SRIMATHI E | / | / | / | / | A | / | / | / | / | / |
| 27 | 73161820503 | SRINIVASAN S | A | / | / | / | / | / | A | / | / | / |
| 28 | 73161820503 | VIGNESH R | / | / | / | / | / | / | / | A | / | / |
| 29 | 73161820503 | VISHNU CHAKKARAVARTHI M | / | A | / | / | / | / | / | / | / | A |
| 30 | ##### | KAMALI R | / | / | / | / | / | / | / | / | / | / |
| Present | | | 25 | 28 | 22 | 26 | 27 | 29 | 25 | 28 | 26 | 27 |
| Absent | | | 5 | 3 | 7 | 4 | 3 | 1 | 5 | 2 | 4 | 3 |

**K S R INSTITUTE FOR ENGINEERING AND TECHNOLOGY
TIRUCHENGODE - 637 215**

TRAINING PROGRAMME FEEDBACK FORM



Name of the Student: Mr. R. Gopal Branch: IT

Year / Sem: II / IV

1. Name of the Training: Virtual mode Technical Training

2. Name of the Trainer: Ms. R. Gopal

3. Students rating of Trainers :

| S. No. | Date | Subject | Rating (✓) | | | |
|--------|------------|---------------------------------|------------|-----------|------|---------|
| | | | Excellent | Very good | Good | Average |
| 1 | 30.04.2020 | Virtual mode Technical Training | ✓ | | | |

4. Two positive points about the programme:

Technical skill training was very nice

5. Suggestions for improvement:

Date: 30.4.2020

R. Gopal
Signature

**K S R INSTITUTE FOR ENGINEERING AND TECHNOLOGY
TIRUCHENGODE - 637 215**

TRAINING PROGRAMME FEEDBACK FORM



Name of the Student: Jayaprakash. G. Branch: Mech.

Year / Sem: II / IV

1. Name of the Training: Virtual mode Technical Training

2. Name of the Trainer: Sathyapriya, AP/CSE

3. Students rating of Trainers :

| S. No. | Date | Subject | Rating (✓) | | | |
|--------|---------|---------------------------------|------------|-----------|------|---------|
| | | | Excellent | Very good | Good | Average |
| 1 | 30.4.20 | Virtual mode Technical Training | ✓ | | | |

4. Two positive points about the programme:

Nothing was excellent and useful.

5. Suggestions for improvement:

Date: 20/6/20

Jayaprakash. G.
 K. S. R. INSTITUTE FOR ENGINEERING AND TECHNOLOGY,
 TIRUCHENGODE - 637 215,
 NAMANKAL DI, TAMIL NADU.
 Signature

**K S R INSTITUTE FOR ENGINEERING AND TECHNOLOGY
TIRUCHENGODE - 637 215**

TRAINING PROGRAMME FEEDBACK FORM



Name of the Student: BEOPALAN . S Branch: MECH

Year / Sem: II / IV

1. Name of the Training : Virtua Mode Technical Training

2. Name of the Trainer : M. Venkatesh

3. Students rating of Trainers :

| S. No. | Date | Subject | Rating (✓) | | | |
|--------|----------------------------|--|------------|-----------|------|---------|
| | | | Excellent | Very good | Good | Average |
| 1 | 20/04/20 to 30/04/20 | Virtua Mode - Technical Training | ✓ | | | |

4. Two positive points about the programme:

The technical training was very useful for attending placement

5. Suggestions for improvement:

Date: 30.04.2020

S. Boopathy
Signature

**K S R INSTITUTE FOR ENGINEERING AND TECHNOLOGY
TIRUCHENGODE - 637 215**

TRAINING PROGRAMME FEEDBACK FORM



Name of the Student: RATKOMAR S Branch: MECH

Year / Sem: II / IV

1. Name of the Training : Virtua mode Technical Training

2. Name of the Trainer : venkatesh

3. Students rating of Trainers :

| S. No. | Date | Subject | Rating (✓) | | | |
|--------|----------------------------|---------------------------------------|------------|-----------|------|---------|
| | | | Excellent | Very good | Good | Average |
| 1 | 20/04/20 to 30/04/20 | Virtua mode Technical Train ing | ✓ | | | |

4. Two positive points about the programme: this session was

5. Suggestions for improvement:

Date: 30.04.2020

Principal
K. S. R. INSTITUTE FOR
ENGINEERING AND TECHNOLOGY
K. S. R. INSTITUTE FOR
TIRUCHENGODE - 637 215,
NAMAKKAL Dt, TAMIL NADU
Signature



K S R INSTITUTE FOR ENGINEERING AND TECHNOLOGY

Tiruchengode, Namakkal – 637215

(Accredited by NBA, Affiliated to Anna University, Chennai)

Department of Mechanical Engineering

Value Added Course – Syllabus

The course covers the topics you need to review for the **AutoCAD** including:

Module 1: INTRODUCTION TO AUTOCAD

6

AutoCAD Screen Components- Drawing Area Command -Window Navigation bar Status bar
AUTOCAD Introduction-Software Requirements- Files handling in CAD- Draw toolbar- Modify
toolbar- Dimensioning toolbar- Opening an Existing Drawing- Quitting AutoCAD

Module 2: Introduction to OF Tool bars

7

Functional keys and properties - Layers and leaders- Tool menu customization- Geometric
constraints- Dimension constraints- Drawing Lines in AutoCAD- Invoking tools Using Dynamic
INPUT/Command- Prompt Coordinate Systems

Module 3: Starting With Advanced Sketching

8

Drawing Arcs- Drawing Rectangles -Drawing Ellipses- Drawing Regular Polygon- Drawing
Polylines Placing Points -Drawing Infinite Lines Writing a Single Line Text- Working with Layers-
Object Properties- Drafting Settings dialog box

Module 4: Editing Sketched Objects

9

Editing Sketches- Moving the Sketched Objects -Copying the Sketched Objects- Creating Multiple
Copies Creating a Single Copy Offsetting Sketched Objects- Rotating Sketched Objects Scaling the
Sketched Objects -Filletting the Sketches- Chamfering the Sketches- Trimming the Sketched Objects
Extending the Sketched Objects- Stretching the Sketched Objects -Lengthening the Sketched
Objects -objects Text Mirroring

Module 5: Isometric Drawings

8

Isometric drawings- Extrusion-View, visual styles and orbit- Solid (3D) modelling- Solid editing
operations- Rendering and scenes

COORDINATOR

Dr..M. VENKATESAN, M.E., Ph.D.,
PRINCIPAL,
K S R INSTITUTE FOR
ENGINEERING AND TECHNOLOGY,
K.S.R. KALVI NAGAR,
TIRUCHENGODE-637 215,
NAMAKKAL Dt, TAMIL NADU.

Total: 38 Hours



K S R INSTITUTE FOR ENGINEERING AND TECHNOLOGY
Tiruchengode, Namakkal – 637215
(Accredited by NBA, Affiliated to Anna University, Chennai)

Department of Mechanical Engineering

Value Added Course - AutoCAD

Schedule

Date: 26/06/19

| S.No. | Date | Topic | Name of the Faculty |
|-------|----------|---|--|
| 1. | 01/07/19 | AutoCAD Screen Components- Drawing Area Command Window Navigation bar Status bar AUTOCAD Introduction | Mr.K.Gopalakrishnan & Mr.P.Gopinath |
| 2. | 02/07/19 | Software Requirements- Files handling in CAD- Draw toolbar | Mr.S.Baskaran & Mr. K.Velusamy |
| 3. | 03/07/19 | Modify toolbar- Dimensioning toolbar | Mr.K.Gopalakrishnan & Mr.P.Gopinath |
| 4. | 04/07/19 | Opening an Existing Drawing- Quitting AutoCAD | Mr.S.Baskaran & Mr. K.Velusamy |
| 5. | 05/07/19 | Functional keys and properties - Layers and leaders- Tool menu customization | Mr.K.Gopalakrishnan & Mr.P.Gopinath |
| 6. | 06/07/19 | Geometric constraints- Dimension constraints | Mr.S.Baskaran & Mr. K.Velusamy |
| 7. | 08/07/19 | Drawing Lines in AutoCAD | Mr.K.Gopalakrishnan & Mr.P.Gopinath |
| 8. | 09/07/19 | Invoking tools Using Dynamic INPUT/Command- Prompt Coordinate Systems | Mr.S.Baskaran & Mr. K.Velusamy |
| 9. | 10/07/19 | Drawing Arcs- Drawing Rectangles -Drawing Ellipses | Mr.K.Gopalakrishnan & Mr.P.Gopinath |
| 10. | 11/07/19 | Drawing Regular Polygon- Drawing Polylines Placing Points | Mr.S.Baskaran & Mr. K.Velusamy |
| 11. | 12/07/19 | Drawing Infinite Lines Writing a Single Line Text | Mr.K.Gopalakrishnan & Mr.P.Gopinath |
| 12. | 22/07/19 | Working with Layers- Object Properties- Drafting Settings dialog box | Mr.S.Baskaran & Mr. K.Velusamy |
| 13. | 23/07/19 | Editing Sketches- Moving the Sketched Objects - Copying the Sketched Objects | Mr.K.Gopalakrishnan & Mr.P.Gopinath |
| 14. | 24/07/19 | Creating Multiple Copies Creating a Single Copy Offsetting Sketched Objects- Rotating Sketched Objects Scaling the Sketched Objects | Mr.S.Baskaran & Mr. K.Velusamy |
| 15. | 25/07/19 | Filleting the Sketches- Chamfering the Sketches- Trimming the Sketched Objects Extending the Sketched Objects | Mr.K.Gopalakrishnan & Mr.P.Gopinath |
| 16. | 26/07/19 | Stretching the Sketched Objects -Lengthening the Sketched Objects -objects Text Mirroring | Mr.S.Baskaran & Mr. K.Velusamy |

Dr. M. VENKATESAN, M.E., Ph.D.,
PRINCIPAL,
K S R INSTITUTE FOR
ENGINEERING AND TECHNOLOGY,
K.S.R. KALVI NAGAR,
TIRUCHENGODE-637 215,
NAMAKKAL Dt, TAMIL NADU.

| | | | |
|-----|----------|--|-------------------------------------|
| 17. | 29/07/19 | Isometric drawings- Extrusion | Mr.K.Gopalakrishnan & Mr.P.Gopinath |
| 18. | 30/07/19 | View, visual styles and orbit | Mr.S.Baskaran & Mr. K.Velusamy |
| 19. | 31/07/19 | Solid (3D) modelling | Mr.K.Gopalakrishnan & Mr.P.Gopinath |
| 20. | 01/08/19 | Solid editing operations- Rendering and scenes | Mr.S.Baskaran & Mr. K.Velusamy |

P. S. S.
COORDINATOR

[Signature]

[Signature]
HOD

Dr..M. VENKATESAN, M.E., Ph.D.,
PRINCIPAL,
K S R INSTITUTE FOR
ENGINEERING AND TECHNOLOGY,
K.S.R. KALVI NAGAR,
TIRUCHENGODE-637 215,
NAMAKKAL DI, TAMIL NADU.

K S R Institute for Engineering and Technology
Department of Mechanical Engineering
Value Added Course on AUTO CAD

Year:II

Attendance

Academic Year:2019-20

| S.NO | REG.NO | NAME OF THE STUDENT | 01.07.19 | 02.07.19 | 03.07.19 | 04.07.19 | 05.07.19 | 06.07.19 | 08.07.19 | 09.07.19 | 10.07.19 | 11.07.19 | 12.07.19 | 22.07.19 | 23.07.19 | 24.07.19 | 25.07.19 | 26.07.19 | 29.07.19 | 30.07.19 | 31.07.19 | 01.08.19 |
|--------------------|--------------|---------------------|----------|----------|----------|----------|----------|----------|----------|----------|----------|----------|----------|----------|----------|----------|----------|----------|----------|----------|----------|----------|
| 1 | 731618114001 | ARIHARAN M | / | / | / | / | / | / | / | / | / | / | / | / | / | / | / | / | / | / | / | / |
| 2 | 731618114002 | ARIVAZHAHAN R | / | / | / | / | / | / | / | / | / | / | / | / | / | / | / | / | / | / | / | / |
| 3 | 731618114003 | ARULBHARATHI G V | / | / | / | / | A | / | / | / | / | / | / | / | / | / | / | / | / | / | / | / |
| 4 | 731618114004 | ARUN PRAKASH K A | / | / | / | / | / | / | / | / | / | / | / | / | / | / | / | / | / | / | / | / |
| 5 | 731618114005 | BOOBALAN S | / | / | / | / | / | / | / | / | / | / | / | / | / | / | / | / | / | / | / | / |
| 6 | 731618114006 | CHANDRU K | / | / | / | / | / | / | / | / | / | / | / | A | / | / | / | / | / | / | / | / |
| 7 | 731618114007 | DHANASEKAR D | / | / | / | / | / | / | / | / | / | / | / | / | / | / | / | / | / | / | / | A |
| 8 | 731618114008 | DHARANEESHWARAN N | / | A | / | / | / | / | / | / | / | / | / | / | / | / | / | / | / | / | / | / |
| 9 | 731618114010 | GOPINATH S | / | / | / | / | / | / | / | / | / | / | / | / | / | / | / | / | / | / | / | / |
| 10 | 731618114011 | GOWTHAM K | / | / | / | / | / | / | / | / | / | / | / | / | / | A | / | / | / | / | / | / |
| 11 | 731618114012 | JAYAPRAKASH S | / | / | / | / | / | / | / | / | / | / | / | / | / | / | / | / | / | / | / | / |
| 12 | 731618114013 | KARTHICK RAJA V | / | / | / | / | / | / | / | / | / | / | / | / | / | / | / | / | / | / | / | / |
| 13 | 731618114014 | KAVIN S | / | / | / | / | / | / | / | / | / | / | / | / | / | / | / | / | / | / | A | / |
| 14 | 731618114015 | KAVIN KUMAR S | / | / | / | / | / | / | / | / | / | / | / | / | / | / | / | / | / | / | / | / |
| 15 | 731618114016 | KAVIRAJ G | / | / | / | / | / | / | / | / | / | / | / | / | / | / | / | / | / | / | / | / |
| 16 | 731618114017 | KRISHNAKUMAR R | / | / | / | / | / | / | / | A | / | / | / | / | / | / | / | / | / | / | / | / |
| 17 | 731618114018 | KRISHNAN S | / | / | A | / | / | / | / | / | / | / | / | / | / | / | / | / | / | / | / | / |
| 18 | 731618114019 | MANIKANDAN P | / | / | / | / | / | / | / | / | / | / | / | / | / | / | / | / | / | / | / | / |
| 19 | 731618114020 | MANIVASAGAM M | / | / | / | / | / | / | / | / | / | / | / | / | / | / | / | / | / | / | / | / |
| 20 | 731618114021 | MONISHVARAN T | / | / | / | / | / | / | / | / | / | / | / | / | / | / | / | / | / | / | / | / |
| 21 | 731618114022 | PRASANTH S | / | / | / | / | / | / | / | / | / | / | / | / | / | / | A | / | / | / | / | / |
| 22 | 731618114023 | PRAVEEN M | / | / | / | / | / | / | / | / | / | / | / | / | / | / | / | / | / | / | / | / |
| 23 | 731618114024 | RAJASEKAR S | / | / | / | / | / | / | / | / | / | / | / | / | / | / | / | / | / | A | / | / |
| 24 | 731618114025 | RAMKUMAR S | / | / | / | / | / | / | / | / | / | / | / | / | / | / | / | / | / | / | / | / |
| 25 | 731618114026 | SAMRAT G | / | / | / | / | / | / | / | / | / | A | / | / | / | / | / | / | / | / | / | / |
| 26 | 731618114027 | SARAN K | A | / | / | / | / | / | / | / | / | / | / | / | / | / | / | / | / | / | / | / |
| 27 | 731618114028 | SELVARAJ K | / | / | / | / | / | / | / | / | / | / | / | / | / | / | / | / | / | / | / | / |
| 28 | 731618114029 | SRIDHAR P | / | / | / | / | / | / | / | / | / | / | / | / | A | / | / | / | / | / | / | A |
| 29 | 731618114030 | SRINATH S | / | / | / | / | / | / | / | / | / | / | / | / | / | / | / | / | / | / | / | / |
| 30 | 731618114031 | SUDARSHAN R | / | / | / | / | / | / | / | / | / | / | / | / | / | / | / | / | / | / | / | / |
| 31 | 731618114032 | VENKATESH P | / | / | / | / | / | / | / | / | / | / | / | / | / | / | / | / | / | / | / | / |
| 32 | 731618114033 | VIGNESH G | / | / | / | / | / | / | / | / | / | / | / | / | / | / | / | / | / | / | / | / |
| 33 | 731618114034 | VIJAY S | / | / | / | / | / | / | / | / | / | / | / | / | / | / | / | / | / | / | / | / |
| 34 | 731618114035 | VIKRAM S | / | / | / | / | / | / | / | / | / | / | / | / | / | / | / | / | / | / | / | / |
| 35 | 731618114036 | YOGESH G | / | / | / | A | / | / | / | / | / | / | / | / | / | / | / | / | A | / | / | / |
| Course Coordinator | | | / | / | / | / | / | / | / | / | / | / | / | / | / | / | / | / | / | / | / | / |
| HoD | | | / | / | / | / | / | / | / | / | / | / | / | / | / | / | / | / | / | / | / | / |

D. M. VENKATESH, M.E., Ph.D.,
 PRINCIPAL,
 K S R INSTITUTE FOR
 ENGINEERING AND TECHNOLOGY,
 K.S.R. KALVI NAGAR
 TIRUCHENGOORU - 621 012

KSR INSTITUTE FOR ENGINEERING AND TECHNOLOGY
DEPARTMENT OF MECHANICAL ENGINEERING

Centre for Value Added Education (CENVAE)

Assessment Test for AUTOCAD course

Attend any one question

Date: 11.8.2019

MARK (50)

1. Draw the following 2D diagram in AUTOCAD software.

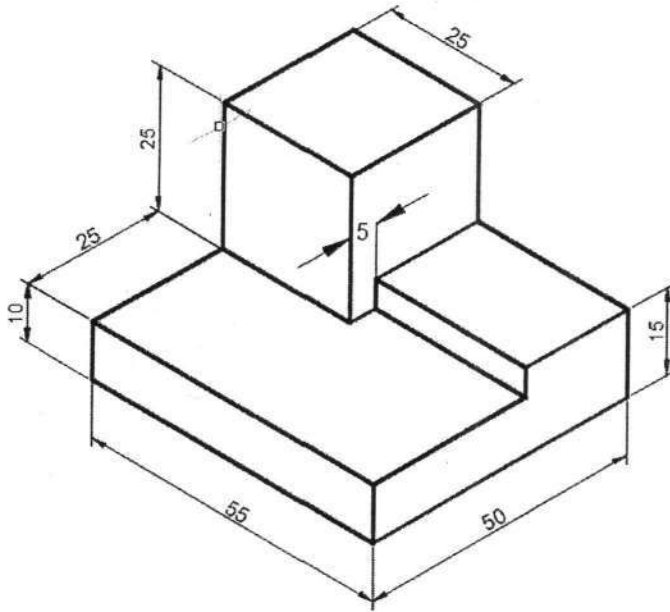

2. Draw the following 2D diagram in AUTOCAD software.

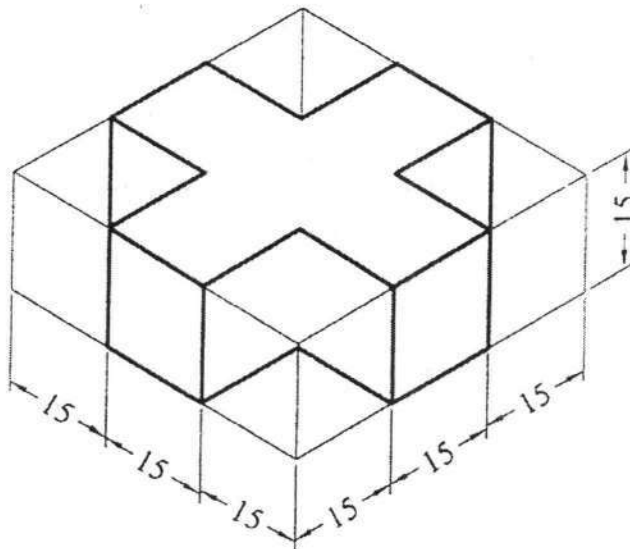

COORDINATOR

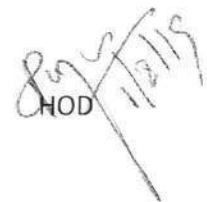

Dr. M. VENKATESAN, M.E., Ph.D.,
PRINCIPAL,
K S R INSTITUTE FOR
ENGINEERING AND TECHNOLOGY,
K.S.R. KALVI NAGAR,
TIRUCHENGODE-637 215,
NAMAKKAL Dt, TAMIL NADU.

HOD
11/2/19

K S R Institute for Engineering and Technology
Department of Mechanical Engineering
Value Added Course on AUTOCAD

Year:II Assessment Mark Acadimic Year:2019-20

| S.NO | REG.NO | NAME OF THE STUDENT | Marks(50) |
|--------------------|--------------|---------------------|-----------|
| 1 | 731618114001 | ARIHARAN M | 45 |
| 2 | 731618114002 | ARIVAZHAHAN R | 41 |
| 3 | 731618114003 | ARULBHARATHI G V | 42 |
| 4 | 731618114004 | ARUN PRAKASH KA | 48 |
| 5 | 731618114005 | BOOBALAN S | 39 |
| 6 | 731618114006 | CHANDRU K | 40 |
| 7 | 731618114007 | DHANASEKAR D | 42 |
| 8 | 731618114008 | DHARANEESHWARAN N | 40 |
| 9 | 731618114010 | GOPINATH S | 42 |
| 10 | 731618114011 | GOWTHAM K | 46 |
| 11 | 731618114012 | JAYAPRAKASH S | 42 |
| 12 | 731618114013 | KARTHICK RAJA V | 41 |
| 13 | 731618114014 | KAVIN S | 45 |
| 14 | 731618114015 | KAVIN KUMAR S | 46 |
| 15 | 731618114016 | KAVIRAJ G | 42 |
| 16 | 731618114017 | KRISHNAKUMAR R | 41 |
| 17 | 731618114018 | KRISHNAN S | 40 |
| 18 | 731618114019 | MANIKANDAN P | 45 |
| 19 | 731618114020 | MANIVASAGAM M | 47 |
| 20 | 731618114021 | MONISHVARAN T | 48 |
| 21 | 731618114022 | PRASANTH S | 42 |
| 22 | 731618114023 | PRAVEEN M | 45 |
| 23 | 731618114024 | RAJASEKAR S | 41 |
| 24 | 731618114025 | RAMKUMAR S | 44 |
| 25 | 731618114026 | SAMRAT G | 40 |
| 26 | 731618114027 | SARAN K | 41 |
| 27 | 731618114028 | SELVARAJ K | 47 |
| 28 | 731618114029 | SRIDHAR P | 38 |
| 29 | 731618114030 | SRINATH S | 39 |
| 30 | 731618114031 | SUDARSHAN R | 41 |
| 31 | 731618114032 | VENKATESH P | 39 |
| 32 | 731618114033 | VIGNESH G | 41 |
| 33 | 731618114034 | VIJAY S | 45 |
| 34 | 731618114035 | VIKRAM S | 41 |
| 35 | 731618114036 | YOGESH G | 40 |
| Course Coordinator | | | |
| HoD | | | |

Dr. M. VENKATESAN, M.E., Ph.D.,
 PRINCIPAL,
 K S R INSTITUTE FOR
 ENGINEERING AND TECHNOLOGY,
 K.S.R. KALVI NAGAR,
 TIRUCHENGODE-637 215,
 NAMAKKAL Dt, TAMIL NADU.



K S R INSTITUTE FOR ENGINEERING AND TECHNOLOGY
Tiruchengode, Namakkal – 637215

(Accredited by NBA, Affiliated to Anna University, Chennai)

Department of Mechanical Engineering

Value Added Course - AutoCAD

Date : 01/08/19

FEEDBACK FORM

Tick the Appropriate Columns:

| Parameter | Excellent | Very Good | Good | Satisfactory |
|--------------------|-----------|-----------|------|--------------|
| Content Delivered | / | | | |
| Registration | / | | | |
| Program Management | / | / | | |
| Hospitality | / | | | |
| About Campus | / | | | |

Participant Name: *S. Vijay*

Suggestions for Improvement:

S. Vijay
Signature of the Participant

[Signature]
Dr., M. VENKATESAN, M.E., Ph.D.,
PRINCIPAL,
K S R INSTITUTE FOR
ENGINEERING AND TECHNOLOGY,
K.S.R. KALVI NAGAR,
TIRUCHENGODE-637 215,
NAMAKKAL DT, TAMIL NADU.

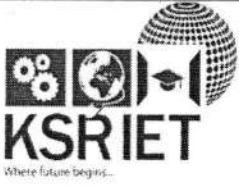

K S R INSTITUTE FOR ENGINEERING AND TECHNOLOGY
Tiruchengode, Namakkal – 637215

(Accredited by NBA, Affiliated to Anna University, Chennai)

Department of Mechanical Engineering

Value Added Course - AutoCAD

Date : 01/08/19

FEEDBACK FORM

Tick the Appropriate Columns:

| Parameter | Excellent | Very Good | Good | Satisfactory |
|--------------------|-----------|-----------|------|--------------|
| Content Delivered | ✓ | | | |
| Registration | ✓ | | | |
| Program Management | | | | |
| Hospitality | ✓ | | | |
| About Campus | ✓ | | | |

Participant Name: *Praveen*

Suggestions for Improvement:

[Signature]
Dr..M. VENKATESAN, M.E., Ph.D.,
PRINCIPAL,
K S R INSTITUTE FOR
ENGINEERING AND TECHNOLOGY,
K.S.R. KALVI NAGAR,
TIRUCHENGODE-637 215,
NAMAKKAL Dt, TAMIL NADU.

[Signature]
Signature of the Participant



K S R INSTITUTE FOR ENGINEERING AND TECHNOLOGY

Tiruchengode, Namakkal – 637 215

(Accredited by NBA, Affiliated to Anna University, Chennai)

DEPARTMENT OF MECHANICAL ENGINEERING

Academic Year: 2019-20

Value Added Course on “Auto CAD”

Duration:

CONSOLIDATED FEEDBACK FORM

| Parameter | Excellent | Very Good | Good | Satisfactory |
|------------------------|-----------|-----------|------|--------------|
| Content | 18 | 8 | 6 | 3 |
| Clarity of Explanation | 14 | 12 | 7 | 2 |
| Interactive Teaching | 16 | 8 | 8 | 3 |
| Doubt Clarification | 19 | 11 | 4 | 1 |
| Program Management | 16 | 8 | 8 | 3 |

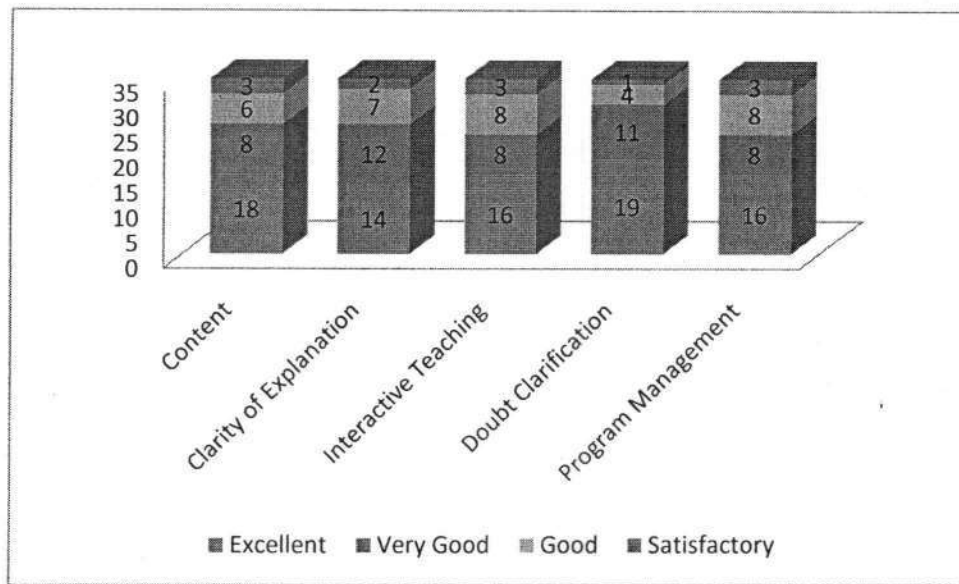

A. S. S.
Course Co-ordinator
18/19

[Signature]
Dr. M. VENKATESAN, M.E., Ph.D.,
PRINCIPAL,
K S R INSTITUTE FOR
ENGINEERING AND TECHNOLOGY,
K.S.R. KALVI NAGAR,
TIRUCHENGODE-637 215,
NAMAKKAL Dt, TAMIL NADU.

[Signature]
HoD

K S R INSTITUTE FOR ENGINEERING AND TECHNOLOGY

TIRUCHENGODE – 637 215

DEPARTMENT OF MECHANICAL ENGINEERING

VALUE ADDED / SHORT TERM COURSE – SUMMARY

Academic Year: 2019-20 (ODD)

| | |
|---|---|
| Name of the course | Value Added / Short Term course on AUTOCAD |
| Course Contents | ➤ Enclosed |
| Course Outcomes | <ul style="list-style-type: none">➤ Evaluate mechanical designs and select the proper process and materials for production.➤ Create 2D and 3D computer drawings and models for manufacturing and prototyping.➤ Evaluate computer aided design models and assemblies based on critical thinking and problem solving skills.➤ Collaborate with people of diverse backgrounds and abilities.➤ Develop a solution through group work.➤ Communicate and present ideas and solutions to design problems. |
| Program Outcomes & Program Specific Outcomes | PO1,PO3,PO4,PO5,PO6,PO9,P10,PO12, PSO2 |
| Course Convener | Dr.P.Murugesan,HoD/MECH |
| Course Coordinators | Mr.S.Ponnusamy AP/MECH |
| Resource Persons | Mr.K.Gopalakrishnan Mr.P.Gopinath Mr.S.Baskaran Mr. K.Velusamy |
| Duration & Dates | 38 Hours & 01/07/19 to 01/08/19 |
| Participants & Strength | II YEAR MECH KSRIET STUDENTS & 35 |

Coordinator

Dr. M. VENKATESAN, M.E., Ph.D.,
PRINCIPAL,
K S R INSTITUTE FOR
ENGINEERING AND TECHNOLOGY,
K.S.R. KALVI NAGAR,
TIRUCHENGODE-637 215,
NAMAKKAL Dt, TAMIL NADU.

Convener

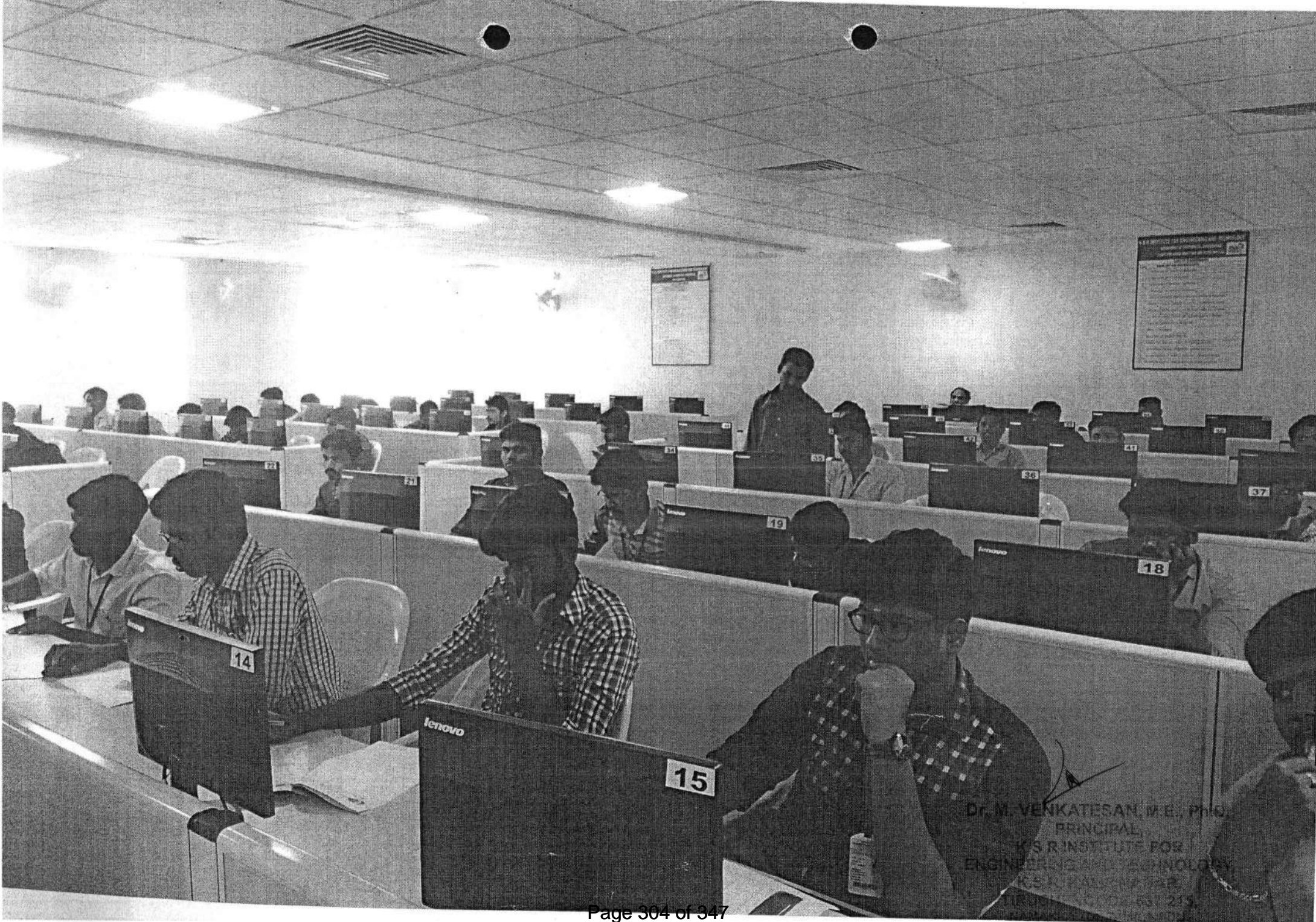



K S R INSTITUTE FOR ENGINEERING & TECHNOLOGY, TIRUCHENGODE

(APPROVED BY AICTE, NEW DELHI, ACCREDITED BY NBA AND AFFILIATED TO ANNA UNIVERSITY, CHENNAI)

DEPARTMENT OF MECHANICAL ENGINEERING CENTRE FOR VALUE ADDED EDUCATION (CENVAE)

VALUE ADDED COURSE AUTOCAD

CERTIFICATE OF PARTICIPATION

This is to certify that Mr. /Ms. S. KAVIN of 10 year
Department of Mechanical Engineering, K S R INSTITUTE FOR
ENGINEERING AND TECHNOLOGY has attended value added course on
"AUTOCAD" organized by the Department of Mechanical Engineering,
K S R IET from 01/07/19 to 1/08/19.

[Signature]
COURSE COORDINATOR

[Signature]
HOD

[Signature]
IQAC COORDINATOR

[Signature]
PRINCIPAL

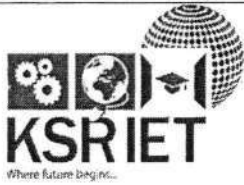

Value Added Course – Syllabus

The course covers the topics you need to review for the Creo for Automation and production including:

Module 1: Advance Part Modeling

6

Advanced Selection Techniques - Advanced Datum Features - Advanced Sketching Techniques - Create advanced holes - Create advanced drafts and ribs - Create advanced shells - Create advanced rounds and chamfers - Use relations and parameters - Create advanced blends

Module 2: Assembly Design

7

Use advanced component selection - Use advanced assembly constraints - Create and use component interfaces - Utilize intelligent fasteners Extension (IFX) - Create and use flexible components - Restructure and mirror assemblies - Use assembly features and shrink wrap - Replace components in an assembly

Module 3: Creo Simulation & Structural Analysis

8

Introduction to Creo Simulate - Theoretical Foundations - Structural Mechanics - Simulation Models - Explore materials and material properties - Understand and use structural constraints - Understand and use structural loads – Meshing - Understand convergence - Run structural analyses

Module 4: Flexible Modeling

9

Understand Flexible Modeling basics - Apply shape surface selection - Perform flexible transform operations on geometry - Use the various transform options - Attach and remove geometry

Module 5: Behavioural Modeling

8

Apply the behavioral modeling process and concepts - Create measurement analysis features - Creating Model Property Features - Creating Analysis Features - Conducting Design Studies and Optimizing Models.

Total period:38

COORDINATOR

Dr. M. VENKATESAN, M.E., Ph.D.,
PRINCIPAL,
K S R INSTITUTE FOR
ENGINEERING AND TECHNOLOGY,
K.S.R. KALVI NAGAR,
TIRUCHENGODE-637 215,
NAMAKKAL DT, TAMIL NADU.

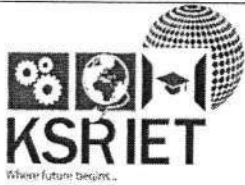

K S R INSTITUTE FOR ENGINEERING AND TECHNOLOGY
Tiruchengode, Namakkal – 637215

Department of Mechanical Engineering

Value Added Course – CREO FOR AUTOMATION AND PRODUCTION

Schedule

Date: 28/05/2019

| No. | Date | Topic | Name of the Faculty |
|-----|----------|---|-------------------------------------|
| 1. | 17/06/19 | Advanced Selection Techniques - Advanced Datum Features - Advanced Sketching Techniques - Create advanced holes - Create advanced drafts and ribs - Create advanced shells - Create advanced rounds and chamfers - Use relations and parameters - Create advanced blends | Mr.S.Ponnusamy & Mr.R.Vasanthakumar |
| 2. | 18/06/19 | Use advanced component selection - Use advanced assembly constraints - Create and use component interfaces - Utilize intelligent fasteners Extension (IFX) - Create and use flexible components - Restructure and mirror assemblies - Use assembly features and shrink wrap - Replace components in an assembly | Mr.S.Balamurugan & Mr.A.Mohanraj |
| 3. | 19/06/19 | Introduction to Creo Simulate - Theoretical Foundations - Structural Mechanics - Simulation Models - Explore materials and material properties - Understand and use structural constraints - Understand and use structural loads – Meshing - Understand convergence - Run structural analyses | Mr.S.Ponnusamy & Mr.R.Vasanthakumar |
| 4. | 20/06/19 | Understand Flexible Modeling basics - Apply shape surface selection - Perform flexible transform operations on geometry - Use the various transform options - Attach and remove geometry | Mr.S.Balamurugan & Mr.A.Mohanraj |
| 5. | 21/06/19 | Apply the behavioral modeling process and concepts - Create measurement analysis features - Creating Model Property Features - Creating Analysis Features - Conducting Design Studies and Optimizing Models. | Mr.S.Ponnusamy & Mr.R.Vasanthakumar |

COORDINATOR

Dr., M. VENKATESAN, M.E., Ph.D.,
PRINCIPAL,
K S R INSTITUTE FOR
ENGINEERING AND TECHNOLOGY,
K.S.R. KALVI NAGAR,
TIRUCHENGODE-637 215,
NAMAKKAL DISTRICT, TAMIL NADU.

HOD

K S R Institute for Engineering and Technology
Department of Mechanical Engineering
Value Added Course on Creo for Automation And Production

Year:III

Attendance

Academic Year:2019-20

| S.NO | REG.NO | NAME OF THE STUDENT | 17.06.19 | 18.06.19 | 19.06.19 | 20.06.19 | 21.06.19 |
|------|--------------|----------------------|----------|----------|----------|----------|----------|
| 1 | 731617114001 | AADHI VISHWANATH M | P | P | P | P | P |
| 2 | 731617114002 | AJITH R | P | P | P | P | P |
| 3 | 731617114004 | ARUNESH J | P | P | P | P | P |
| 4 | 731617114005 | ARUN KUMAR S | P | P | A | P | P |
| 5 | 731617114006 | ARUN KUMAR T | P | P | P | P | P |
| 6 | 731617114007 | ARUN PRABAKARAN J | P | A | P | P | P |
| 7 | 731617114008 | ASWANTH KUMAR K | P | P | P | P | P |
| 8 | 731617114009 | ASWIN M | P | P | P | P | P |
| 9 | 731617114010 | BALAJI S | P | P | P | P | P |
| 10 | 731617114011 | BHAGAVATHI PERUMAL G | P | P | P | P | P |
| 11 | 731617114012 | BHARANIDHARAN R | P | P | P | P | P |
| 12 | 731617114013 | BOOPATHI S | P | P | P | P | P |
| 13 | 731617114014 | BOOPATHIRAJA M | P | P | P | P | P |
| 14 | 731617114016 | CHANDRU K | P | P | P | P | P |
| 15 | 731617114017 | CHANDRU M | P | P | P | P | P |
| 16 | 731617114018 | CHANDRU S | P | P | P | A | P |
| 17 | 731617114019 | DEEPAK K | P | P | P | P | P |
| 18 | 731617114020 | DHARANKUMAR S | P | P | P | P | P |
| 19 | 731617114021 | DHARSHAN C M | P | P | P | P | P |
| 20 | 731617114022 | DINESHKUMAR D | P | P | P | P | P |
| 21 | 731617114023 | DINESHKUMAR R | P | P | P | P | P |
| 22 | 731617114026 | GOBIRAJ R | P | P | P | P | P |
| 23 | 731617114027 | GOKULNATH K | P | P | P | P | P |
| 24 | 731617114028 | GOKULPRASANTH M | P | P | P | P | P |
| 25 | 731617114029 | GOKULRAJ B | P | P | P | P | P |
| 26 | 731617114030 | GOVINDHARASU R | P | P | P | P | P |
| 27 | 731617114031 | GOWTHAM KUMAR T | P | P | P | P | P |
| 28 | 731617114032 | GUNASEELAN C | P | P | P | P | P |
| 29 | 731617114033 | HARIHARAN G | P | P | P | P | P |
| 30 | 731617114035 | HARIPRASATH P | P | P | P | P | P |
| 31 | 731617114036 | HARIRAM B | P | P | P | P | P |
| 32 | 731617114038 | JAGATHESHWARAN N | P | P | P | A | P |
| 33 | 731617114039 | KAMALESH T | P | P | P | P | P |
| 34 | 731617114040 | KARTHICK R | P | P | P | P | P |
| 35 | 731617114041 | KARTHIK A S | P | P | P | P | P |
| 36 | 731617114042 | KARTHIKEYAN S | P | P | P | P | P |
| 37 | 731617114043 | KARTHIKEYAN T | P | P | P | P | P |
| 38 | 731617114044 | KARUPPAIAH K | P | P | P | P | P |
| 39 | 731617114045 | KATHIRVEL M | P | P | P | P | P |
| 40 | 731617114046 | KAVIN M | P | P | P | P | P |
| 41 | 731617114047 | KAVIN M | P | P | P | P | P |
| 42 | 731617114048 | KAVINKUMAR C | P | P | P | P | P |
| 43 | 731617114050 | KIRUBAKARAN K | P | P | P | P | P |
| 44 | 731617114051 | KIRUBAKARAN K | P | P | P | P | P |
| 45 | 731617114052 | LOGESH M | P | P | P | P | P |
| 46 | 731617114053 | MADESH K | P | P | P | P | P |
| 47 | 731617114054 | MANIKANDAN R | P | P | P | P | P |
| 48 | 731617114055 | MANOJ N | P | P | P | P | P |
| 49 | 731617114056 | MEIYANANDHAN V | P | P | P | P | P |
| 50 | 731617114057 | MOHAMED ABBAS M | P | P | P | P | P |

Dr. M. VENKATESAN, M.E., Ph.D.,
 PRINCIPAL,
 K S R INSTITUTE FOR
 ENGINEERING AND TECHNOLOGY,
 K S R W L NAGAR,
 TIRUCHENGODE-637 215.

| S.NO | REG.NO | NAME OF THE STUDENT | 17.06.19 | 18.06.19 | 19.06.19 | 20.06.19 | 21.06.19 |
|--------------------|--------------|---------------------|----------|----------|----------|----------|----------|
| 51 | 731617114058 | MOHANARAJ C | P | P | P | P | P |
| 52 | 731617114059 | MONISH KANNA M | P | P | P | P | P |
| 53 | 731617114060 | MUNESWARAN D | P | P | P | P | P |
| 54 | 731617114061 | NANDHAKUMAR G | P | P | P | A | P |
| 55 | 731617114062 | NARESH M | P | P | P | P | P |
| 56 | 731617114063 | NAVEEN M | P | P | P | P | P |
| 57 | 731617114064 | NAVEEN V | P | P | P | P | P |
| 58 | 731617114065 | NIKHIL S | P | P | P | P | P |
| 59 | 731617114066 | NITHISH M | P | P | P | P | P |
| 60 | 731617114067 | PAVITHRAN G | P | P | P | P | P |
| 61 | 731617114069 | PRADEEP N | P | P | P | P | P |
| 62 | 731617114070 | PRADHAP R | P | P | P | P | P |
| 63 | 731617114071 | PRAGATHEESWAR E | P | P | P | P | P |
| 64 | 731617114072 | PRASATH R | P | P | P | P | P |
| 65 | 731617114073 | PRATHIYUMANAN M | P | P | P | P | P |
| 66 | 731617114074 | PRAVEEN H | P | P | P | P | P |
| 67 | 731617114075 | PRAVEENKUMAR V | P | P | P | P | P |
| 68 | 731617114076 | PRAVEEN KUMAR S | P | P | P | P | P |
| 69 | 731617114077 | PREMRAJ S | P | P | P | P | P |
| 70 | 731617114078 | RAHUL V | P | P | P | P | P |
| 71 | 731617114079 | RAMKUMAR B | P | P | P | P | P |
| 72 | 731617114080 | RANJITHKUMAR K | P | P | P | P | P |
| 73 | 731617114081 | SABARINATHAN S | P | P | P | P | P |
| 74 | 731617114082 | SAKTHIVEL P | P | P | P | P | P |
| 75 | 731617114083 | SANTHOSHKUMAR G | P | P | P | P | P |
| 76 | 731617114085 | SARATH KUMAR M | P | P | P | P | P |
| 77 | 731617114086 | SARAVANAA M | P | P | A | P | P |
| 78 | 731617114087 | SARAVANAN R | P | P | P | P | P |
| 79 | 731617114088 | SASIKARAN S | P | P | P | P | P |
| 80 | 731617114089 | SATHISHKUMAR S | P | P | P | P | P |
| 81 | 731617114090 | SHAJAHAN S | P | P | P | A | P |
| 82 | 731617114091 | SRIDHAR C | P | P | P | P | P |
| 83 | 731617114092 | SRIDHARAN R | P | P | P | P | P |
| 84 | 731617114093 | SURENDHAR P | P | P | P | P | P |
| 85 | 731617114094 | SURESHKUMAR A | P | P | P | P | P |
| 86 | 731617114095 | SURESHMOORTHY P | P | P | P | P | P |
| 87 | 731617114096 | SURYAMOORTHI R | P | P | P | P | P |
| 88 | 731617114098 | TAMILSELVAN V | P | P | P | P | P |
| 89 | 731617114099 | THAMIL SELVAM B | P | P | P | P | P |
| 90 | 731617114100 | THIRUPATHI M | P | P | P | P | P |
| 91 | 731617114101 | THULASI RAMAN R | P | P | P | P | P |
| 92 | 731617114102 | VIGNESH R | P | P | P | P | P |
| 93 | 731617114103 | VIGNESHWARAN S | P | P | P | P | P |
| 94 | 731617114104 | VIJAYAKUMAR C | P | P | P | P | P |
| 95 | 731617114106 | VINOTH KUMAR T | P | P | P | P | P |
| 96 | 731617114107 | YASWANTHKARTHIK S | P | P | P | P | P |
| 97 | 731617114108 | YOGESH N | P | P | A | P | P |
| 98 | 731617114301 | ABISHEK R R | P | P | P | P | P |
| 99 | 731617114302 | DHINESHWARAN G | P | P | P | P | P |
| 100 | 731617114303 | HARIPRASATH M | P | P | P | P | P |
| 101 | 731617114304 | KANNAN E | A | P | P | P | P |
| 102 | 731617114305 | MANIKANDAN V | P | P | P | P | P |
| 103 | 731617114306 | NANTHAKUMAR P | P | P | P | P | P |
| Course Coordinator | | | | | | | |
| HoD | | | | | | | |

DR. M. VENKATESAN, M.E., Ph.D.
PRINCIPAL,
K S R INSTITUTE FOR
ENGINEERING AND TECHNOLOGY,
K.S.R. KALVI NAGAR,
TIRUCHENGODE-637 215,
TAMIL NADU

K S R Institute for Engineering and Technology
Department of Mechanical Engineering
Value Added Course on Creo for Automation and Production

Year:III

Assessment Mark

Academic Year:2019-20

| S.NO | REG.NO | NAME OF THE STUDENT | Marks(50) |
|------|--------------|----------------------|-----------|
| 1 | 731617114001 | AADHI VISHWANATH M | 42 |
| 2 | 731617114002 | AJITH R | 39 |
| 3 | 731617114004 | ARUNESH J | 40 |
| 4 | 731617114005 | ARUN KUMAR S | 41 |
| 5 | 731617114006 | ARUN KUMAR T | 40 |
| 6 | 731617114007 | ARUN PRABAKARAN J | 42 |
| 7 | 731617114008 | ASWANTH KUMAR K | 42 |
| 8 | 731617114009 | ASWIN M | 40 |
| 9 | 731617114010 | BALAJI S | 39 |
| 10 | 731617114011 | BHAGAVATHI PERUMAL G | 45 |
| 11 | 731617114012 | BHARANIDHARAN R | 42 |
| 12 | 731617114013 | BOOPATHI S | 42 |
| 13 | 731617114014 | BOOPATHIRAJA M | 41 |
| 14 | 731617114016 | CHANDRU K | 41 |
| 15 | 731617114017 | CHANDRU M | 42 |
| 16 | 731617114018 | CHANDRU S | 42 |
| 17 | 731617114019 | DEEPAK K | 42 |
| 18 | 731617114020 | DHARANKUMAR S | 40 |
| 19 | 731617114021 | DHARSHAN C M | 39 |
| 20 | 731617114022 | DINESHKUMAR D | 39 |
| 21 | 731617114023 | DINESHKUMAR R | 45 |
| 22 | 731617114026 | GOBIRAJ R | 42 |
| 23 | 731617114027 | GOKULNATH K | 41 |
| 24 | 731617114028 | GOKULPRASANTH M | 43 |
| 25 | 731617114029 | GOKULRAJ B | 45 |
| 26 | 731617114030 | GOVINDHARASU R | 44 |
| 27 | 731617114031 | GOWTHAM KUMAR T | 42 |
| 28 | 731617114032 | GUNASEELAN C | 45 |
| 29 | 731617114033 | HARIHARAN G | 42 |
| 30 | 731617114035 | HARIPRASATH P | 45 |
| 31 | 731617114036 | HARIRAM B | 41 |
| 32 | 731617114038 | JAGATHESHWARAN N | 43 |
| 33 | 731617114039 | KAMALESH T | 44 |
| 34 | 731617114040 | KARTHICK R | 45 |
| 35 | 731617114041 | KARTHIK A S | 42 |
| 36 | 731617114042 | KARTHIKEYAN S | 43 |
| 37 | 731617114043 | KARTHIKEYAN T | 41 |
| 38 | 731617114044 | KARUPPAIAH K | 42 |
| 39 | 731617114045 | KATHIRVEL M | 41 |
| 40 | 731617114046 | KAVIN M | 41 |
| 41 | 731617114047 | KAVIN M | 41 |
| 42 | 731617114048 | KAVINKUMAR C | 40 |
| 43 | 731617114050 | KIRUBAKARAN K | 45 |
| 44 | 731617114051 | KIRUBAKARAN K | 42 |
| 45 | 731617114052 | LOGESH M | 41 |
| 46 | 731617114053 | MADESH K | 39 |
| 47 | 731617114054 | MANIKANDAN R | 39 |
| 48 | 731617114055 | MANOJ N | 41 |
| 49 | 731617114056 | MEIYANANDHAN V | 42 |
| 50 | 731617114057 | MOHAMED ABBAS M | 41 |

Dr. M. VENKATESAN, M.E., Ph.D.,
 PRINCIPAL,
 K S R INSTITUTE FOR
 ENGINEERING AND TECHNOLOGY,
 K.S.R. KALVI NAGAR,
 TIRUCHENGODE-637 215,
 NAMAKKAL DL, TAMIL NADU.

| S.NO | REG.NO | NAME OF THE STUDENT | Marks(50) |
|--------------------|--------------|---------------------|-----------|
| 51 | 731617114058 | MOHANARAJ C | 45 |
| 52 | 731617114059 | MONISH KANNA M | 43 |
| 53 | 731617114060 | MUNEESWARAN D | 41 |
| 54 | 731617114061 | NANDHAKUMAR G | 40 |
| 55 | 731617114062 | NARESH M | 43 |
| 56 | 731617114063 | NAVEEN M | 39 |
| 57 | 731617114064 | NAVEEN V | 39 |
| 58 | 731617114065 | NIKHIL S | 40 |
| 59 | 731617114066 | NITHISH M | 40 |
| 60 | 731617114067 | PAVITHRAN G | 45 |
| 61 | 731617114069 | PRADEEP N | 45 |
| 62 | 731617114070 | PRADHAP R | 42 |
| 63 | 731617114071 | PRAGATHEESWAR E | 43 |
| 64 | 731617114072 | PRASATH R | 41 |
| 65 | 731617114073 | PRATHIYUMANAN M | 42 |
| 66 | 731617114074 | PRAVEEN H | 45 |
| 67 | 731617114075 | PRAVEENKUMAR V | 42 |
| 68 | 731617114076 | PRAVEEN KUMAR S | 42 |
| 69 | 731617114077 | PREMRAJ S | 41 |
| 70 | 731617114078 | RAHUL V | 42 |
| 71 | 731617114079 | RAMKUMAR B | 45 |
| 72 | 731617114080 | RANJITHKUMAR K | 42 |
| 73 | 731617114081 | SABARINATHAN S | 39 |
| 74 | 731617114082 | SAKTHIVEL P | 40 |
| 75 | 731617114083 | SANTHOSHKUMAR G | 40 |
| 76 | 731617114085 | SARATH KUMAR M | 39 |
| 77 | 731617114086 | SARAVANAA M | 45 |
| 78 | 731617114087 | SARAVANAN R | 42 |
| 79 | 731617114088 | SASIKARAN S | 43 |
| 80 | 731617114089 | SATHISHKUMAR S | 44 |
| 81 | 731617114090 | SHAJAHAN S | 44 |
| 82 | 731617114091 | SRIDHAR C | 45 |
| 83 | 731617114092 | SRIDHARAN R | 42 |
| 84 | 731617114093 | SURENDHAR P | 44 |
| 85 | 731617114094 | SURESHKUMAR A | 45 |
| 86 | 731617114095 | SURESHMOORTHY P | 45 |
| 87 | 731617114096 | SURYAMOORTHI R | 44 |
| 88 | 731617114098 | TAMILSELVAN V | 41 |
| 89 | 731617114099 | THAMIL SELVAM B | 42 |
| 90 | 731617114100 | THIRUPATHI M | 43 |
| 91 | 731617114101 | THULASI RAMAN R | 44 |
| 92 | 731617114102 | VIGNESH R | 41 |
| 93 | 731617114103 | VIGNESHWARAN S | 45 |
| 94 | 731617114104 | VIJAYAKUMAR C | 39 |
| 95 | 731617114106 | VINOTH KUMAR T | 44 |
| 96 | 731617114107 | YASWANTHKARTHIK S | 41 |
| 97 | 731617114108 | YOGESH N | 45 |
| 98 | 731617114301 | ABISHEK R R | 39 |
| 99 | 731617114302 | DHINESHWARAN G | 45 |
| 100 | 731617114303 | HARIPRASATH M | 42 |
| 101 | 731617114304 | KANNAN E | 43 |
| 102 | 731617114305 | MANIKANDAN V | 41 |
| 103 | 731617114306 | NANTHAKUMAR P | 45 |
| Course Coordinator | | | |
| HoD | | | |

Dr. M. VENKATESAN, M.E., Ph.D.
 PRINCIPAL,
 K S R INSTITUTE FOR
 ENGINEERING AND TECHNOLOGY,
 K.S.R. KALVI NAGAR
 TIRUCHENGODE
 NAMAKKAL DISTRICT



K S R INSTITUTE FOR ENGINEERING AND TECHNOLOGY
Tiruchengode, Namakkal – 637215

Department of Mechanical Engineering

**Value Added Course - CREO FOR AUTOMATION AND
PRODUCTION**

Date: 21/06/19

FEEDBACK FORM

Tick the Appropriate Columns:

| Parameter | Excellent | Very Good | Good | Satisfactory |
|--------------------|-------------------------------------|-------------------------------------|--------------------------|--------------------------|
| Content Delivered | <input checked="" type="checkbox"/> | <input type="checkbox"/> | <input type="checkbox"/> | <input type="checkbox"/> |
| Registration | <input checked="" type="checkbox"/> | <input type="checkbox"/> | <input type="checkbox"/> | <input type="checkbox"/> |
| Program Management | <input type="checkbox"/> | <input checked="" type="checkbox"/> | <input type="checkbox"/> | <input type="checkbox"/> |
| Hospitality | <input checked="" type="checkbox"/> | <input type="checkbox"/> | <input type="checkbox"/> | <input type="checkbox"/> |
| About Campus | <input checked="" type="checkbox"/> | <input type="checkbox"/> | <input type="checkbox"/> | <input type="checkbox"/> |

Participant Name: *M. Aswin*

Suggestions for Improvement:

Dr. M. VENKATESAN, M.E., Ph.D.,
PRINCIPAL,
K S R INSTITUTE FOR
ENGINEERING AND TECHNOLOGY,
K.S.R. KALVI NAGAR,
TIRUCHENGODE-637 215,
NAMAKKAL Dt, TAMIL NADU.

M. Aswin
Signature of the Participant



K S R INSTITUTE FOR ENGINEERING AND TECHNOLOGY
Tiruchengode, Namakkal – 637215

Department of Mechanical Engineering

Value Added Course - CREO FOR AUTOMATION AND PRODUCTION

Date: 21/06/19

FEEDBACK FORM

Tick the Appropriate Columns:

| Parameter | Excellent | Very Good | Good | Satisfactory |
|--------------------|-----------|-----------|------|--------------|
| Content Delivered | ✓ | | | |
| Registration | | ✓ | | |
| Program Management | | | ✓ | |
| Hospitality | ✓ | | | |
| About Campus | | ✓ | | |

Participant Name: Deepak K

Suggestions for Improvement:

Signature of the Participant

Dr. M. VENKATESAN, M.E., Ph.D.,
PRINCIPAL,
K S R INSTITUTE FOR
ENGINEERING AND TECHNOLOGY,
K.S.R. KALVI NAGAR,
TIRUCHENGODE-637 215,
NAMAKKAL Dt, TAMIL NADU.



K S R INSTITUTE FOR ENGINEERING AND TECHNOLOGY

Tiruchengode, Namakkal – 637 215

(Accredited by NBA, Affiliated to Anna University, Chennai)

DEPARTMENT OF MECHANICAL ENGINEERING

Academic Year: 2019-20

Value Added Course on “CREO AUTOMATION AND PRODUCTION”

Duration:

CONSOLIDATED FEEDBACK FORM

| Parameter | Excellent | Very Good | Good | Satisfactory |
|------------------------|-----------|-----------|------|--------------|
| Content | 60 | 25 | 14 | 4 |
| Clarity of Explanation | 75 | 14 | 13 | 1 |
| Interactive Teaching | 80 | 15 | 7 | 1 |
| Doubt Clarification | 65 | 25 | 8 | 8 |
| Program Management | 55 | 35 | 12 | 1 |

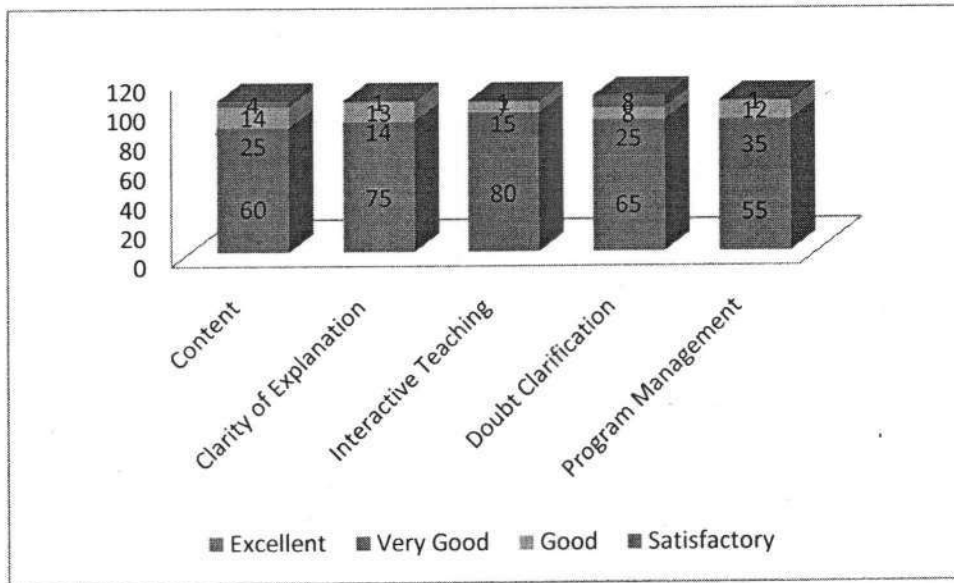

[Signature]
Course Co-ordinator

[Signature]
Dr. M. VENKATESAN, M.E., Ph.D.,
PRINCIPAL,
K S R INSTITUTE FOR
ENGINEERING AND TECHNOLOGY,
K.S.R. KALVI NAGAR,
TIRUCHENGODE-637 215,
NAMAKKAL Dt, TAMIL NADU.

[Signature]
HoD

K S R INSTITUTE FOR ENGINEERING AND TECHNOLOGY

TIRUCHENGODE – 637 215

DEPARTMENT OF MECHANICAL ENGINEERING

VALUE ADDED / SHORT TERM COURSE – SUMMARY

Academic Year: 2019-20 (ODD)

| | |
|---|--|
| Name of the course | Five days Value Added / Short Term course on CREO AUTOMATION AND PRODUCTION |
| Course Contents | ➤ Enclosed |
| Course Outcomes | <ul style="list-style-type: none">➤ Student will have seamless data sharing ability; they can easily design entire process, from concept design work to manufacturing the final product.➤ Student can automatically do associative manufacturing and service deliverables generation.➤ Student can add manufacturing businesses transition into model-based enterprises.➤ Student will have enough skills to increase productivity, do better concept design, increase engineering & manufacturing capabilities, and do better simulation and additive manufacturing. |
| Program Outcomes & Program Specific Outcomes | PO1,PO3,PO4,PO5,PO6,PO9,P10,PO12, PSO2 |
| Course Convener | Dr.P.MURUGESAN, HoD/MECH |
| Course Coordinators | Mr.S.Ponnusamy AP/MECH |
| Resource Persons | Mr.S.Ponnusamy Mr.R.Vasanthakumar Mr.S.Balamurugan Mr.A.Mohanraj |
| Duration & Dates | Five days (38 Hours) & 17/06/19 to 21/06/19 |
| Participants & Strength | III YEAR MECH KSRIET STUDENTS & 103 |

Coordinator

Dr. M. VENKATESAN, M.E., Ph.D.,
PRINCIPAL,
K S R INSTITUTE FOR
ENGINEERING AND TECHNOLOGY,
K.S.R. KALVI NAGAR,
TIRUCHENGODE-637 215,
NAMAKKAL DL, TAMIL NADU.

Convener

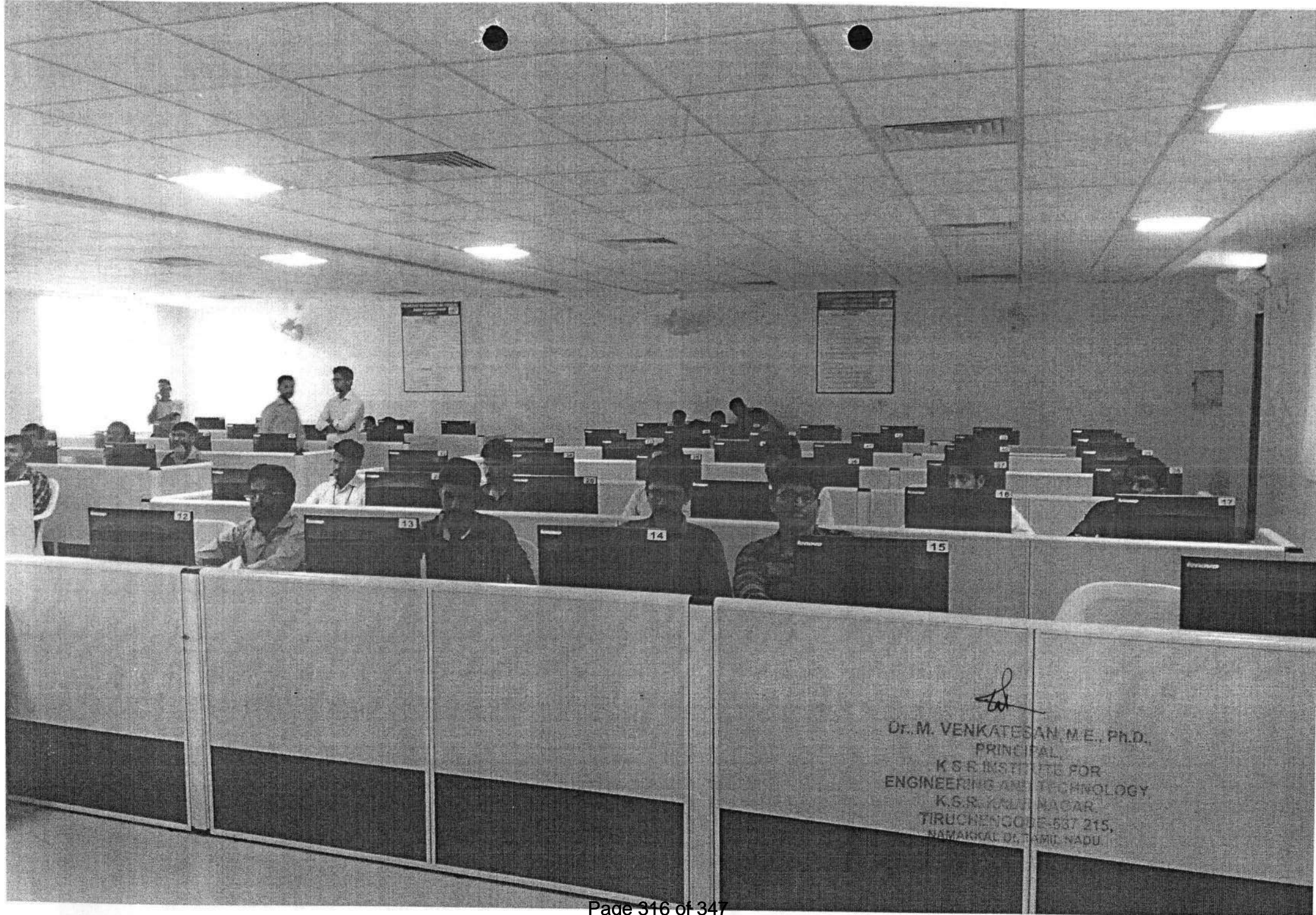



K S R INSTITUTE FOR ENGINEERING & TECHNOLOGY

(APPROVED BY AICTE, NEW DELHI AND AFFILIATED TO ANNA UNIVERSITY, CHENNAI)



DEPARTMENT OF MECHANICAL ENGINEERING CENTRE FOR VALUE ADDED EDUCATION (CEMVAE)

VALUE ADDED COURSE CREO - AUTOMATION AND PRODUCTION

CERTIFICATE OF PARTICIPATION

This is to certify that Mr. /Ms. K. DEEPAK of III YEAR
Department of Mechanical Engineering, K S R INSTITUTE FOR ENGINEERING AND
TECHNOLOGY has attended a Five days value added course on "Creo
Automation and production" organized by the Department of Mechanical
Engineering, KSR IET from 17.06.19 to 21.06.19

COORDINATOR

HOD

IQAC COORDINATOR

DR. M. VENKATESAN, M.E., Ph.D.
PRINCIPAL

K S R INSTITUTE FOR
ENGINEERING AND TECHNOLOGY

SALEEM NAGAR,
TIRUCHENGODE-637 215,
NAMAKKAL Dt, TAMIL NADU.



Value Added Course – Computer Numerical Control (CNC) Syllabus

| S. No | Topic | Hours |
|-------|--|-------|
| 1 | <u>INTRODUCTION</u> | 8 |
| | <ul style="list-style-type: none"> ➤ Intro to CAD/CAM/CAE ➤ History & Features of CNC ➤ Software fundamentals Terminology | |
| 2 | <u>GRAPHICAL USER INTERFACE & COORDINATE SYSTEMS</u> | 8 |
| | Coordinate Systems - Absolute & Relative coordinates | |
| 3 | <u>CNC LATHE</u> | 8 |
| | BASICS OF CNC LATHE <ul style="list-style-type: none"> ➤ Tool Changing, Billet Setting & Axis BASICS CODES <ul style="list-style-type: none"> ➤ G codes - G00, G01, G02, etc ➤ M codes - M00, M01, M02, etc ➤ Letters relations | |
| 4 | <u>CNC MILLING</u> | 10 |
| | BASICS OF CNC MILLING <ul style="list-style-type: none"> ➤ Tool Changing, Billet Setting & Axis SIMPLE OPERATION <ul style="list-style-type: none"> ➤ Linear movement & Circular movement OTHER OPERATION <ul style="list-style-type: none"> ➤ Mirror, Sub program call, Pocketing, & Drilling | |

COORDINATOR *[Signature]*

[Signature]
Dr. M. VENKATESAN, M.E., Ph.D.
PRINCIPAL,
K S R INSTITUTE FOR
ENGINEERING AND TECHNOLOGY,
K.S.R. KALVI NAGAR,
TIRUCHENGODE-637 215,
NAMAKKAL DISTRICT, TAMIL NADU.

Total Period: 34



K S R INSTITUTE FOR ENGINEERING AND TECHNOLOGY
Tiruchengode, Namakkal – 637215
(Accredited by NBA, Affiliated to Anna University, Chennai)
Department of Mechanical Engineering

Six Days Value Added Course – Computer Numerical Control (CNC)

Schedule

Date: 10/12/2019

| No. | Date | Topic | Name of the Faculty |
|-----|----------|--|--------------------------------------|
| 1. | 04/01/20 | Introduction to CAD/CAM/CAE, History & Features of CNC Software fundamentals Terminology | Mr.P.Chakravarthi & Mr.S.Rajkumar |
| 2. | 11/01/20 | Graphical User Interface & Coordinate Systems Coordinate Systems - Absolute & Relative coordinates | Mr.J.Mathan & Mr.P.Karthick |
| 3. | 25/01/20 | Basics of CNC Lathe Tool Changing, Billet Setting & Axis Basics Codes G codes - G00, G01, G02, etc M codes - M00, M01, M02, etc Letters relations | Mr.P.Chakravarthi & Mr.S.Rajkumar |
| 4. | 08/02/20 | Basics of CNC Milling Tool Changing, Billet Setting & Axis | Mr.J.Mathan & Mr.P.Karthick |
| 5. | 15/02/20 | Simple Operation Linear movement & Circular movement | Mr.P.Chakravarthi & Mr.S.Rajkumar |
| 6. | 22/02/20 | Other Operation Mirror, Sub program call, Pocketing, & Drilling | Mr.J.Mathan & Mr.P.Karthick |

Coordinator

Dr. M. VENKATESAN, M.E., Ph.D
PRINCIPAL,
K S R INSTITUTE FOR
ENGINEERING AND TECHNOLOGY
K.S.R. KALVI NAGAR,
TIRUCHENGODE-637 215,
NAMAKKAL Dt, TAMIL NADU.

HOD

K S R Institute for Engineering and Technology
Department of Mechanical Engineering
Value Added Course on Computer Numerical Control (CNC)

Year: IV

Attendance

Academic Year:2019-20

| S.NO | REG.NO | NAME OF THE STUDENT | 04.01.2020 | 11.01.2020 | 25.01.2020 | 08.02.2020 | 15.02.2020 | 22.02.2020 |
|------|--------------|---------------------|------------|------------|------------|------------|------------|------------|
| 1 | 731616114003 | Annamalai K | P | P | P | P | AB | P |
| 2 | 731616114005 | Aswinkumar S | P | P | AB | P | P | P |
| 3 | 731616114006 | Bharath V | P | P | P | P | P | P |
| 4 | 731616114010 | Chellathurai T | P | P | P | P | P | P |
| 5 | 731616114011 | Deepak R | P | P | P | AB | P | P |
| 6 | 731616114012 | Dhayanidhi M | P | P | P | P | P | P |
| 7 | 731616114014 | Dhinakaran P | P | P | P | P | P | P |
| 8 | 731616114019 | Govindasamy A | P | P | P | P | P | P |
| 9 | 731616114022 | Hariharan M | P | P | P | P | P | P |
| 10 | 731616114024 | Hari Shankar P | P | P | P | P | P | P |
| 11 | 731616114025 | Inbarasan C | P | P | P | P | P | P |
| 12 | 731616114027 | Jayamurugan K S | P | P | P | P | P | P |
| 13 | 731616114032 | Kaleeswaran D | P | AB | P | P | P | P |
| 14 | 731616114033 | Karole Infanto D | P | P | P | P | P | P |
| 15 | 731616114034 | Karthikeyan P | P | P | P | P | P | P |
| 16 | 731616114037 | Keerthivasan S | P | P | P | P | P | P |
| 17 | 731616114038 | Kesav Goutham N B | P | P | P | P | P | P |
| 18 | 731616114040 | Kirubakaran M | P | P | P | P | P | P |
| 19 | 731616114041 | Lakshmi Narayanan R | P | AB | P | P | P | P |
| 20 | 731616114047 | Manojkumar K | P | P | P | P | P | P |
| 21 | 731616114048 | Mohammed Nihal R | AB | P | P | P | P | P |
| 22 | 731616114049 | Mohanakrishnan D | P | P | P | AB | P | P |
| 23 | 731616114303 | Barath V | P | P | P | P | P | P |
| 24 | 731616114304 | Ethayakumar G | P | P | P | P | P | P |
| 25 | 731616114305 | Jeevanandham N | P | P | P | P | P | P |
| 26 | 731616114306 | Karthi S | P | P | P | P | P | P |



DR. M. VENKATESAN, M.E., Ph.D.,
 PRINCIPAL,
K S R INSTITUTE FOR
ENGINEERING AND TECHNOLOGY,
 K.S.R. KALVI NAGAR,
 TIRUCHI
 Page 320 of 347

KSR INSTITUTE FOR ENGINEERING AND TECHNOLOGY
DEPARTMENT OF MECHANICAL ENGINEERING

Centre for Value Added Education (CENVAE)
Assessment Test for CNC course

Date:
MARK (50)

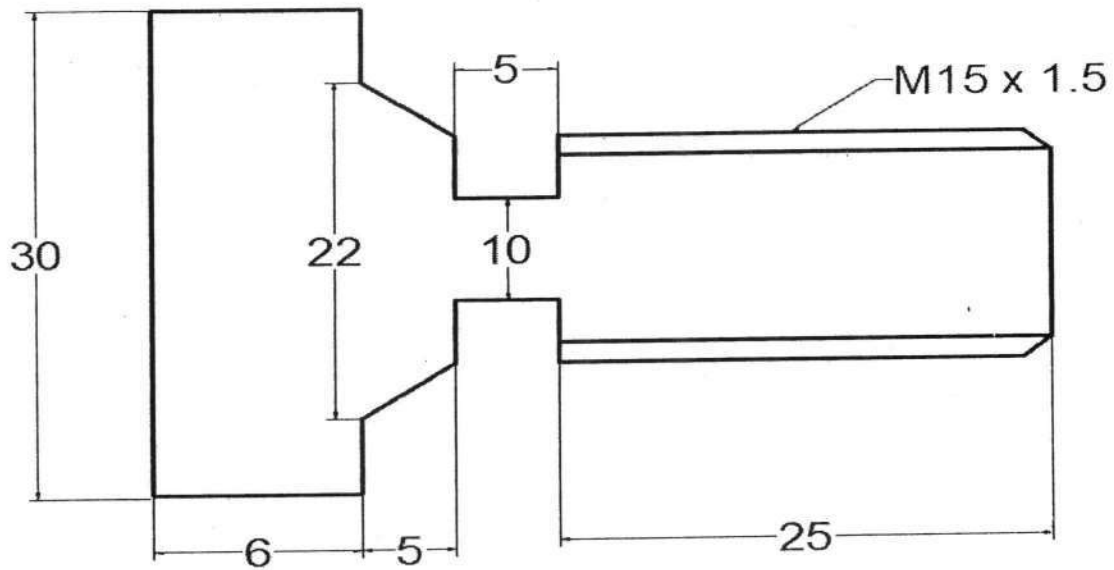
1. Write the part program for following diagram.



COORDINATOR



Dr. M. VENKATESAN, M.E., Ph.D.,
PRINCIPAL,
K S R INSTITUTE FOR
ENGINEERING AND TECHNOLOGY,
K.S.R. KALVI NAGAR,
TIRUCHENGODE-637 215,
NAMAKKAL Dt, TAMIL NADU.

HOD

K S R Institute for Engineering and Technology
Department of Mechanical Engineering
Value Added Course on CNC

Year:IV Assessment Academic Year:2019-20

| S.NO | REG.NO | NAME OF THE STUDENT | MARKS (50) |
|------|--------------|--------------------------|------------|
| 1 | 731616114003 | Annamalai K | 45 |
| 2 | 731616114005 | Aswinkumar S | 42 |
| 3 | 731616114006 | Bharath V | 41 |
| 4 | 731616114010 | Chellathurai T | 40 |
| 5 | 731616114011 | Deepak R | 39 |
| 6 | 731616114012 | Dhayanidhi M | 45 |
| 7 | 731616114014 | Dhinakaran P | 42 |
| 8 | 731616114019 | Govindasamy A | 41 |
| 9 | 731616114022 | Hariharan M | 43 |
| 10 | 731616114024 | Hari Shankar P | 44 |
| 11 | 731616114025 | Inbarasan C | 45 |
| 12 | 731616114027 | Jayamurugan K S | 40 |
| 13 | 731616114032 | Kaleeswaran D | 45 |
| 14 | 731616114033 | Karole Infanto D | 39 |
| 15 | 731616114034 | Karthikeyan P | 42 |
| 16 | 731616114037 | Keerthivasan S | 43 |
| 17 | 731616114038 | Kesav Goutham N B | 41 |
| 18 | 731616114040 | Kirubakaran M | 41 |
| 19 | 731616114041 | Lakshmi Narayanan R | 42 |
| 20 | 731616114047 | Manojkumar K | 43 |
| 21 | 731616114048 | Mohammed Nihal R | 44 |
| 22 | 731616114049 | Mohanakrishnan D | 41 |
| 23 | 731616114303 | Barath V | 45 |
| 24 | 731616114304 | Ethayakumar G | 45 |
| 25 | 731616114305 | Jeevanandham N | 41 |
| 26 | 731616114306 | Karthi S | 40 |
| 27 | 731616114054 | Navinkumar M | 39 |
| 28 | 731616114055 | Parthasarathy R | 39 |
| 29 | 731616114056 | Prabakaran S | 40 |
| 30 | 731616114061 | Praveenkumar S | 39 |
| 31 | 731616114062 | Prem Kumar K R | 40 |
| 32 | 731616114063 | Ragavendhar S | 39 |
| 33 | 731616114065 | Rajkumar S | 42 |
| 34 | 731616114066 | Ranjith R | 39 |
| 35 | 731616114071 | Ruthrannan B | 42 |
| 36 | 731616114073 | Sakthi Gnanasundaram R H | 40 |
| 37 | 731616114074 | Sakthivel R | 45 |
| 38 | 731616114076 | Sanjay Kumar S K | 41 |
| 39 | 731616114077 | Santhoshkumar B | 43 |

Dr. M. VENKATESAN, M.E., Ph.D.,
PRINCIPAL,
K S R INSTITUTE FOR
ENGINEERING AND TECHNOLOGY,
K.S.R. KALVI NAGAR,
TIRUCHENGODE-637 215,
NAMAKKAL Dt., TAMIL NADU.

| | | | |
|--------------------|--------------|----------------|----|
| 40 | 731616114081 | Sathish G | 44 |
| 41 | 731616114082 | Shakthi R M | 41 |
| 42 | 731616114083 | Sowndhar A | 39 |
| 43 | 731616114087 | Thirumurugan V | 40 |
| 44 | 731616114088 | Uthaya Kumar M | 41 |
| 45 | 731616114089 | Vasanth S | 39 |
| 46 | 731616114092 | Vignesh B | 41 |
| 47 | 731616114093 | Vignesh V | 45 |
| 48 | 731616114096 | Vinothmani M | 42 |
| 49 | 731616114099 | Yogaraj G | 43 |
| 50 | 731616114311 | SURENTHARAN.J | 41 |
| Course Coordinator | | | |
| HoD | | | |

Dr. M. VENKATESAN, M.E., Ph.D.,
 PRINCIPAL
 K S R INSTITUTE FOR
 ENGINEERING AND TECHNOLOGY,
 K.S.R. KALVI NAGAR,
 TIRUCHENGODE-637 215,
 NAMAKKAL Dt, TAMIL NADU.



K S R INSTITUTE FOR ENGINEERING AND TECHNOLOGY
Tiruchengode, Namakkal – 637215

Department of Mechanical Engineering

Value Added Course - Computer Numerical Control (CNC)

Date: 22/02/20

FEEDBACK FORM

Tick the Appropriate Columns:

| Parameter | Excellent | Very Good | Good | Satisfactory |
|--------------------|-----------|-----------|------|--------------|
| Content Delivered | / | | | |
| Registration | / | | | |
| Program Management | / | | | |
| Hospitality | / | | | |
| About Campus | | / | | |

Participant Name: *S. Karthi*

Suggestions for Improvement:

S. Karthi
Signature of the Participant

Dr., M. VENKATESAN, M.E., Ph.D.
PRINCIPAL,
K S R INSTITUTE FOR
ENGINEERING AND TECHNOLOGY
K.S.R. KALVI NAGAR,
TIRUCHENGODE-637 215,
NAMARKKAL DI, TAMIL NADU.



K S R INSTITUTE FOR ENGINEERING AND TECHNOLOGY
Tiruchengode, Namakkal – 637215

Department of Mechanical Engineering

Value Added Course - Computer Numerical Control (CNC)

Date: 22/02/20

FEEDBACK FORM

Tick the Appropriate Columns:

| Parameter | Excellent | Very Good | Good | Satisfactory |
|--------------------|-----------|-----------|------|--------------|
| Content Delivered | | ✓ | | |
| Registration | | | ✓ | |
| Program Management | ✓ | | | |
| Hospitality | ✓ | | | ✓ |
| About Campus | | ✓ | | |

Participant Name:

Sharath ✓

Suggestions for Improvement:

✓

Signature of the Participant

Dr. M. VENKATESAN, M.E., Ph.D.,
PRINCIPAL,
K S R INSTITUTE FOR
ENGINEERING AND TECHNOLOGY,
K.S.R. KALVI NAGAR,
TIRUCHENGODE-637 215,
NAMAKKAL Dt, TAMIL NADU.



K S R INSTITUTE FOR ENGINEERING AND TECHNOLOGY

Tiruchengode, Namakkal – 637 215

(Accredited by NBA, Affiliated to Anna University, Chennai)

DEPARTMENT OF MECHANICAL ENGINEERING

Academic Year: 2019-20

Value Added Course on “CNC”

Duration:

CONSOLIDATED FEEDBACK FORM

| Parameter | Excellent | Very Good | Good | Satisfactory |
|------------------------|-----------|-----------|------|--------------|
| Content | 25 | 14 | 8 | 3 |
| Clarity of Explanation | 30 | 15 | 3 | 2 |
| Interactive Teaching | 40 | 7 | 2 | 1 |
| Doubt Clarification | 28 | 12 | 6 | 4 |
| Program Management | 27 | 14 | 7 | 2 |

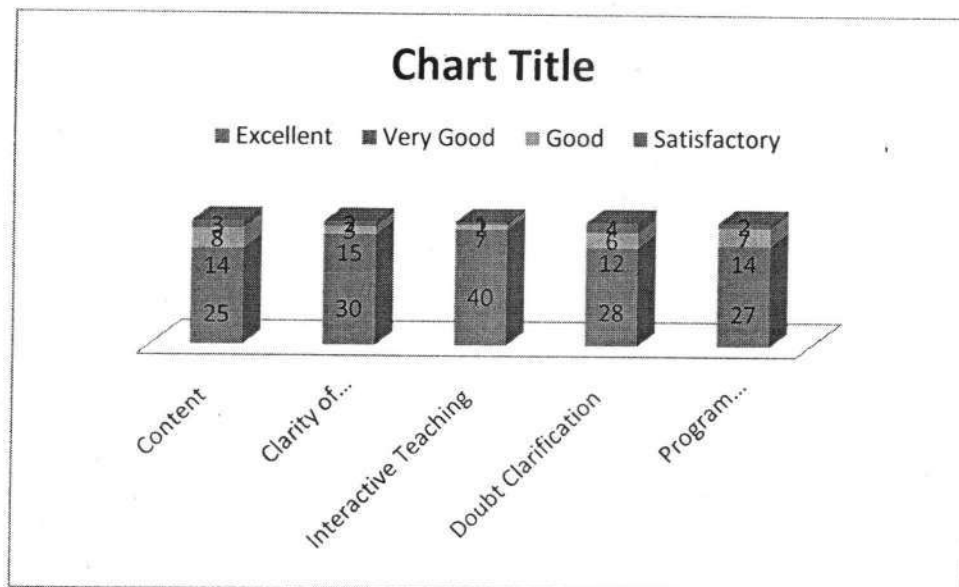

Course Co-ordinator *[Signature]*

[Signature] HoD
 Dr. M. VENKATESAN, M.E., Ph.D.
 PRINCIPAL,
 K S R INSTITUTE FOR
 ENGINEERING AND TECHNOLOGY,
 K.S.R. KALVI NAGAR,
 TIRUCHENGODE-637 215,
 NAMAKKAL Dt, TAMIL NADU.

K S R INSTITUTE FOR ENGINEERING AND TECHNOLOGY

TIRUCHENGODE – 637 215

DEPARTMENT OF MECHANICAL ENGINEERING

VALUE ADDED / SHORT TERM COURSE – SUMMARY

Academic Year: 2019-20 (ODD)

| | |
|---|---|
| Name of the course | Six days Value Added / Short Term course on CNC |
| Course Contents | ➤ Enclosed |
| Course Outcomes | <ul style="list-style-type: none">➤ Students can identify different axes, machine zero, home position, systems and controls CNC machines.➤ Students are able to Select, mount and set cutting tools and tool holders on CNC.➤ Students are able to prepare part programmes using ISO format for given simple components with and without use of MACRO, CANNED CYCLE and SUBROUTINE using ISO format.➤ Students can Interface software application for auto part programming➤ Students are able to apply maintenance practices for CNC machines. |
| Program Outcomes & Program Specific Outcomes | PO1,PO3,PO4,PO5,PO6,PO9,P10,PO12, PSO2 |
| Course Convener | Dr.P.Murugesan,HoD/MECH |
| Course Coordinators | Mr.s.Ponnusamy AP/MECH |
| Resource Persons | Mr.P.Chakravarthi AP/MECH Mr.S.Rajkumar AP/MECH Mr.J.Mathan AP/MECH Mr.P.Karthick AP/MECH |
| Duration & Dates | Six days (34 Hours) & 04/01/20 to 22/02/20 |
| Participants & Strength | IV YEAR MECH KSRIET STUDENTS & 50 |

Coordinator

Convener
Dr..M. VENKATESAN, M.E., Ph.D.,
PRINCIPAL,
K S R INSTITUTE FOR
ENGINEERING AND TECHNOLOGY,
K.S.R. KALVI NAGAR,
TIRUCHENGODE-637 215,
NAMAKKAL DI, TAMIL NADU.

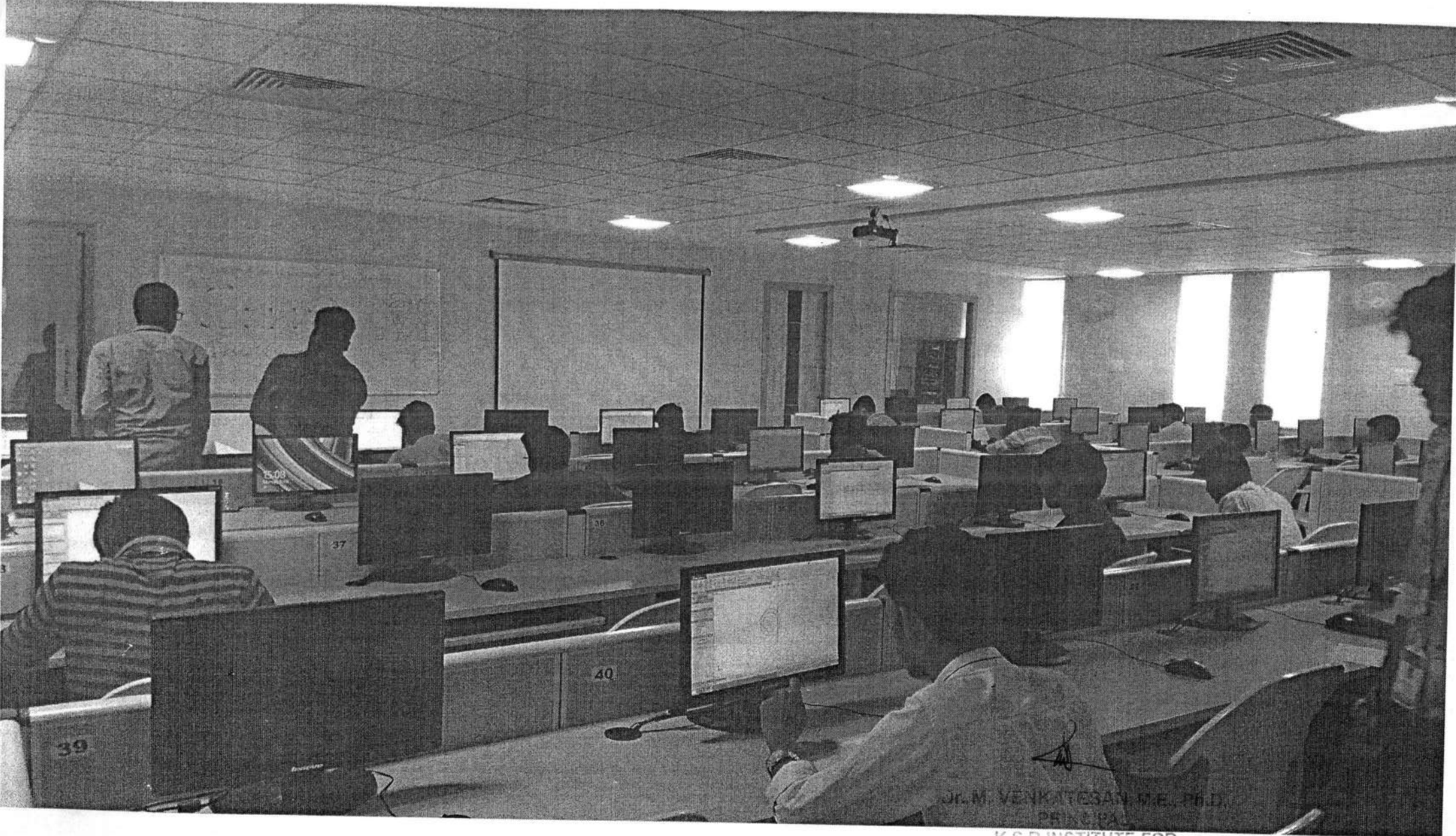

Jr. M. VENKATESAN M.E., Ph.D.
DEAN

K S R INSTITUTE FOR
ENGINEERING AND TECHNOLOGY,
K.S.R. KALVI NAGAR,
TIRUCHENGODE-637 215,
NAMAKKAL Dt, TAMIL NADU.



www.unitedcaddsolution.com

DESIGN THE FUTURE

UNITED CADD SOLUTION
PRIVATE LIMITED

Corporate Office : #516/228-D, Annapuram,
Junction Main Road,
Five Roads, Salem, Tamilnadu -636 004.



**KSR Institute For Engineering
& Technology, Tiruchengode.**
Affiliated to Anna University, Chennai.
Accredited by NBA



CERTIFICATE OF EXCELLENCE

Reg. No. : UCS SLM - 114003

Awarded to : ANNAMALAI K

in : Computer Numerical Control (CNC)

at : K S R INSTITUTE FOR ENGINEERING & TECHNOLOGY

Duration : 40 Hrs

Grade* : ' H '

Date of Issue : MARCH - 2020 *C : 40-50, D : 50-60, A : 60-75, H : Above 75

P. Pray
Course Co-Ordinator
Mech / KSR IET

P. Ven
HOD
Mech / KSR IET

P. Ven
IQAC
Co-Ordinator

M. K. S.
Principal
KSR IET

A. J. S. M.
Director
UNITED CADD SOLUTION

M. VENKATESAN, M.E.,
PRINCIPAL,
K S R INSTITUTE FOR
ENGINEERING AND TECHNOLOGY,
K.S.R. KALVI NAGAR,
TIRUCHENGODE-637 215,
NAMAKKAL DT, TAMIL NADU.



K S R INSTITUTE FOR ENGINEERING AND TECHNOLOGY
Tiruchengode, Namakkal – 637215

Department of Mechanical Engineering

Value Added Course – Syllabus

The course covers the topics you need to review for the **AutoCAD** including:

Module 1: INTRODUCTION TO AUTOCAD

6

AutoCAD Screen Components- Drawing Area Command -Window Navigation bar Status bar
AUTOCAD Introduction-Software Requirements- Files handling in CAD- Draw toolbar- Modify
toolbar- Dimensioning toolbar- Opening an Existing Drawing- Quitting AutoCAD

Module 2: Introduction to OF Tool bars

7

Functional keys and properties - Layers and leaders- Tool menu customization- Geometric
constraints- Dimension constraints- Drawing Lines in AutoCAD- Invoking tools Using Dynamic
INPUT/Command- Prompt Coordinate Systems

Module 3: Starting With Advanced Sketching

8

Drawing Arcs- Drawing Rectangles -Drawing Ellipses- Drawing Regular Polygon- Drawing
Polylines Placing Points -Drawing Infinite Lines Writing a Single Line Text- Working with Layers-
Object Properties- Drafting Settings dialog box

Module 4: Editing Sketched Objects

9

Editing Sketches- Moving the Sketched Objects -Copying the Sketched Objects- Creating Multiple
Copies Creating a Single Copy Offsetting Sketched Objects- Rotating Sketched Objects Scaling the
Sketched Objects -Filletting the Sketches- Chamfering the Sketches- Trimming the Sketched Objects
Extending the Sketched Objects- Stretching the Sketched Objects -Lengthening the Sketched
Objects -objects Text Mirroring

Module 5: Isometric Drawings

8

Isometric drawings- Extrusion-View, visual styles and orbit- Solid (3D) modelling- Solid editing
operations- Rendering and scenes

Total: 38 Hours

COORDINATOR

Dr. M. VENKATESAN, M.E., Ph.D.,
PRINCIPAL.
K S R INSTITUTE FOR
ENGINEERING AND TECHNOLOGY,
K.S.R. KALVI NAGAR,
TIRUCHENGODE-637 215,
NAMAKKAL Dt, TAMIL NADU.



K S R INSTITUTE FOR ENGINEERING AND TECHNOLOGY
Tiruchengode, Namakkal – 637215
Department of Mechanical Engineering

Value Added Course - AutoCAD

Schedule

Date: 08/06/2020

| S.No. | Date | Topic | Name of the Faculty |
|-------|----------|--|---------------------------------|
| 1. | 15/06/20 | AutoCAD Screen Components- Drawing Area Command - Window Navigation bar Status bar AUTOCAD Introduction- Software Requirements- Files handling in CAD- Draw toolbar- Modify toolbar- Dimensioning toolbar- Opening an Existing Drawing- Quitting AutoCAD | Mr.A.Premkumar & Mr.S.Rahul |
| 2. | 16/06/20 | Functional keys and properties - Layers and leaders- Tool menu customization- Geometric constraints- Dimension constraints- Drawing Lines in AutoCAD- Invoking tools Using Dynamic INPUT/Command- Prompt Coordinate Systems | Mr.A.Mohanraj & Mr.P.Manikandan |
| 3. | 17/06/20 | Drawing Arcs- Drawing Rectangles -Drawing Ellipses- Drawing Regular Polygon- Drawing Polylines Placing Points -Drawing Infinite Lines Writing a Single Line Text- Working with Layers- Object Properties- Drafting Settings dialog box | Mr.A.Premkumar & Mr.S.Rahul |
| 4. | 18/06/20 | Editing Sketches- Moving the Sketched Objects -Copying the Sketched Objects- Creating Multiple Copies Creating a Single Copy Offsetting Sketched Objects- Rotating Sketched Objects Scaling the Sketched Objects -Filleting the Sketches- Chamfering the Sketches- Trimming the Sketched Objects Extending the Sketched Objects- Stretching the Sketched Objects -Lengthening the Sketched Objects -objects Text Mirroring | Mr.A.Mohanraj & Mr.P.Manikandan |
| 5. | 19/06/20 | Isometric drawings- Extrusion-View, visual styles and orbit- Solid (3D) modelling- Solid editing operations- Rendering and scenes | Mr.A.Premkumar & Mr.S.Rahul |

[Signature]
COORDINATOR

[Signature]
 Dr. M. VENKATESAN, M.E., Ph.D.,
 PRINCIPAL,
 K S R INSTITUTE FOR
 ENGINEERING AND TECHNOLOGY,
 K.S.R. KALVI NAGAR,
 TIRUCHENGODE-637 215,
 NAMAKKAL Dt, TAMIL NADU.

[Signature]
HOD

K S R Institute for Engineering and Technology
Department of Mechanical Engineering
Value Added Course on AUTO CAD

Year:II

Attendance

Academic Year:2020-21

| S.NO | REG.NO | NAME OF THE STUDENT | 15.06.20 | 16.06.20 | 17.06.20 | 18.06.20 | 19.06.20 |
|----------------------------------|--------------|---------------------|---|--|---|---|---|
| 1 | 731619114001 | AJAYKUMAR G | P | P | P | AB | P |
| 2 | 731619114002 | ARAVIND M | P | P | P | P | P |
| 3 | 731619114005 | BHARANESH M | P | P | P | P | P |
| 4 | 731619114006 | BOOPATHI P | AB | P | P | P | P |
| 5 | 731619114007 | DEEPA M | P | P | AB | P | P |
| 6 | 731619114008 | DHEENADHAYALAN B | P | P | P | P | P |
| 7 | 731619114009 | EZHILVENDEN S | P | P | P | P | P |
| 8 | 731619114010 | GOKULA KANNAN T | P | AB | P | P | P |
| 9 | 731619114011 | GOKULNATH S | P | P | P | P | P |
| 10 | 731619114012 | HARISH P | P | P | P | P | P |
| 11 | 731619114013 | HARISH U | P | P | P | P | P |
| 12 | 731619114014 | HARISH KUMARR HV | P | P | P | P | P |
| 13 | 731619114015 | JAICHANDRAN M | P | P | P | P | P |
| 14 | 731619114016 | KARNAN S | P | P | P | P | AB |
| 15 | 731619114017 | KARTHIKEYAN G | P | P | P | P | P |
| 16 | 731619114018 | KAVIYARASU R | AB | P | P | P | P |
| 17 | 731619114019 | KISHORE P | P | P | P | P | P |
| 18 | 731619114020 | KRITHICKSHAN S | P | P | P | P | P |
| 19 | 731619114021 | MANIKANDAN G | P | P | P | P | P |
| 20 | 731619114022 | MARUTHUPANDI V | P | P | P | P | P |
| 21 | 731619114023 | MUKESH KUMAR C S | P | P | P | P | P |
| 22 | 731619114024 | NACHIYAPPAN A | P | P | P | P | P |
| 23 | 731619114025 | NANDHAKUMAR M | P | P | P | P | P |
| 24 | 731619114026 | NIVAS K | P | AB | P | P | P |
| 25 | 731619114027 | POOVARASAN A | P | P | P | P | P |
| 26 | 731619114028 | RAKESH G G | P | P | P | AB | P |
| 27 | 731619114029 | SANDHIYA R | P | P | P | P | P |
| 28 | 731619114030 | SANTHOSH M | AB | P | P | P | P |
| 29 | 731619114031 | SANTHOSH P | P | P | P | P | P |
| 30 | 731619114032 | SOUNDHARRAJAN S | P | P | P | P | P |
| 31 | 731619114033 | VALLIAPPAN S P | P | P | P | P | P |
| 32 | 731619114034 | VIGNESH P | P | P | P | P | AB |
| 33 | 731619114035 | VIGNESH R | AB | P | P | P | P |
| 34 | 731619114301 | ABISHAKE R V | P | P | P | P | P |
| 35 | 731619114302 | ADHIYAMAAN S | P | P | P | P | P |
| 36 | 731619114303 | DHANAPPRAKASH U | P | P | AB | P | P |
| 37 | 731619114305 | SATHISHKUMAR S | P | P | P | AB | P |
| Course Coordinator | | |  |  |  |  |  |
| HoD | | |  |  |  |  |  |
| Dr., M. VENKATESAN, M.E., Ph.D., | | | | | | | |
| PRINCIPAL, | | | | | | | |

K S R INSTITUTE FOR
ENGINEERING AND TECHNOLOGY,
K. S. R. KALVI NAGAR,
TIRUCHENAI - 621115,

KSR INSTITUTE FOR ENGINEERING AND TECHNOLOGY
DEPARTMENT OF MECHANICAL ENGINEERING

Centre for Value Added Education (CENVAE)

Assessment Test for AUTOCAD course

Attend any one question

Date: 19.06.2020
MARK (50)

- 1 Draw the following 2D diagram in AUTOCAD software.

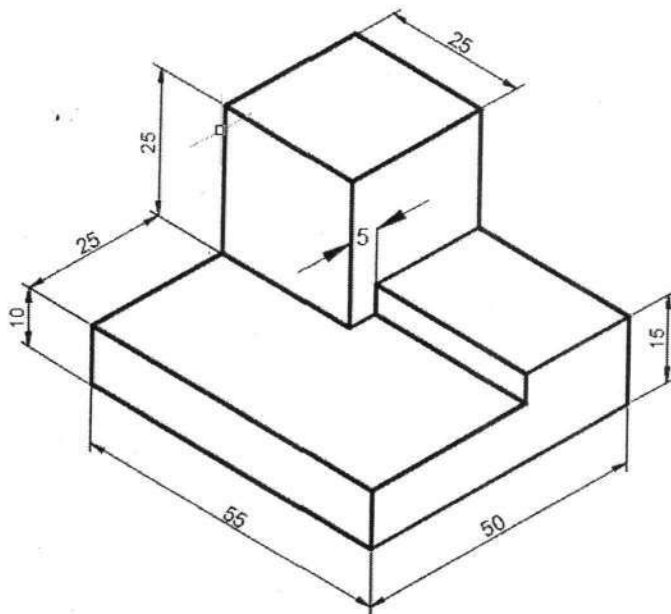

2. Draw the following 2D diagram in AUTOCAD software.

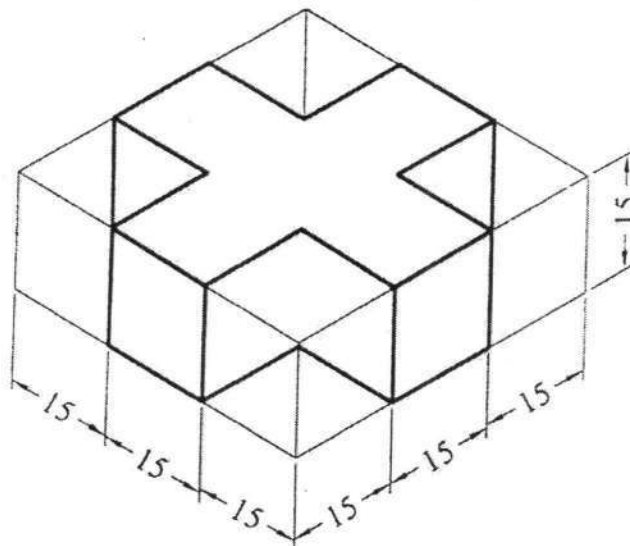

COORDINATOR

Dr. M. VENKATESAN, M.E., Ph.D.,
PRINCIPAL,
K S R INSTITUTE FOR
ENGINEERING AND TECHNOLOGY,
K.S.R. KALVI NAGAR,
TIRUCHENGODE-637 215,
NAMAKKAL Dt. TAMIL NADU.



HOD

K S R Institute for Engineering and Technology
Department of Mechanical Engineering
Value Added Course on AUTO CAD

Year:II

Assessment Mark

Academic Year:2020-21

| S.NO | REG.NO | NAME OF THE STUDENT | Marks(50) |
|---------------------------|--------------|---------------------|---|
| 1 | 731619114001 | AJAYKUMAR G | 45 |
| 2 | 731619114002 | ARAVIND M | 41 |
| 3 | 731619114005 | BHARANESH M | 42 |
| 4 | 731619114006 | BOOPATHI P | 48 |
| 5 | 731619114007 | DEEPA M | 39 |
| 6 | 731619114008 | DHEENADHAYALAN B | 40 |
| 7 | 731619114009 | EZHILVENDEN S | 42 |
| 8 | 731619114010 | GOKULA KANNAN T | 40 |
| 9 | 731619114011 | GOKULNATH S | 42 |
| 10 | 731619114012 | HARISH P | 46 |
| 11 | 731619114013 | HARISH U | 42 |
| 12 | 731619114014 | HARISH KUMARR HV | 41 |
| 13 | 731619114015 | JAICHANDRAN M | 45 |
| 14 | 731619114016 | KARNAN S | 46 |
| 15 | 731619114017 | KARTHIKEYAN G | 42 |
| 16 | 731619114018 | KAVIYARASU R | 41 |
| 17 | 731619114019 | KISHORE P | 40 |
| 18 | 731619114020 | KRITHICKSHAN S | 45 |
| 19 | 731619114021 | MANIKANDAN G | 47 |
| 20 | 731619114022 | MARUTHUPANDI V | 48 |
| 21 | 731619114023 | MUKESH KUMAR C S | 42 |
| 22 | 731619114024 | NACHIYAPPAN A | 45 |
| 23 | 731619114025 | NANDHAKUMAR M | 41 |
| 24 | 731619114026 | NIVAS K | 44 |
| 25 | 731619114027 | POOVARASAN A | 40 |
| 26 | 731619114028 | RAKESH G G | 41 |
| 27 | 731619114029 | SANDHIYA R | 47 |
| 28 | 731619114030 | SANTHOSH M | 38 |
| 29 | 731619114031 | SANTHOSH P | 39 |
| 30 | 731619114032 | SOUNDHARRAJAN S | 41 |
| 31 | 731619114033 | VALLIAPPAN S P | 39 |
| 32 | 731619114034 | VIGNESH P | 41 |
| 33 | 731619114035 | VIGNESH R | 45 |
| 34 | 731619114301 | ABISHAKE R V | 41 |
| 35 | 731619114302 | ADHIYAMAAN S | 40 |
| 36 | 731619114303 | DHANAPPRAKASH U | 39 |
| 37 | 731619114305 | SATHISHKUMAR S | 41 |
| Course Coordinator | | |  |
| HoD | | |  |

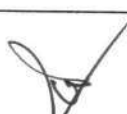
Dr. M. VENKATESAN, M.E., Ph.D.,
 PRINCIPAL,
 K S R INSTITUTE FOR
 ENGINEERING AND TECHNOLOGY,
 K.S.R. KALVI NAGAR,
 TIRUCHENGODE-637 215,
 NAMAKKAL Dt, TAMIL NADU.



K S R INSTITUTE FOR ENGINEERING AND TECHNOLOGY

Tiruchengode, Namakkal – 637 215

(Accredited by NBA, Affiliated to Anna University, Chennai)

DEPARTMENT OF MECHANICAL ENGINEERING

Academic Year: 2020-21

Value Added Course on “Auto CAD”

Duration:

CONSOLIDATED FEEDBACK FORM

| Parameter | Excellent | Very Good | Good | Satisfactory |
|------------------------|-----------|-----------|------|--------------|
| Content | 17 | 11 | 5 | 4 |
| Clarity of Explanation | 17 | 13 | 4 | 3 |
| Interactive Teaching | 18 | 13 | 5 | 2 |
| Doubt Clarification | 20 | 12 | 4 | 1 |
| Program Management | 22 | 8 | 3 | 4 |

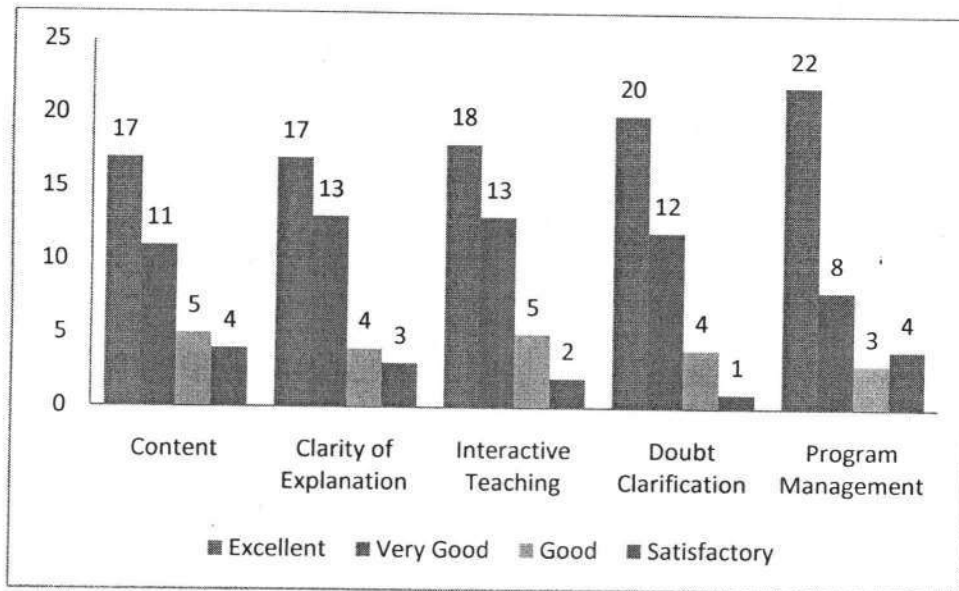

[Signature]
Course Co-ordinator 20/6/20

[Signature]

[Signature]
HoD 20/6/20

Dr., M. VENKATESAN, M.E., Ph.D.,
PRINCIPAL,
K S R INSTITUTE FOR
ENGINEERING AND TECHNOLOGY,
K.S.R. KALVI NAGAR,
TIRUCHENGODE-637 215,
NAMAKKAL Dt, TAMIL NADU.

K S R INSTITUTE FOR ENGINEERING AND TECHNOLOGY

TIRUCHENGODE – 637 215

DEPARTMENT OF MECHANICAL ENGINEERING

VALUE ADDED / SHORT TERM COURSE – SUMMARY

Academic Year: 2020-21 (ODD)

| | |
|---|---|
| Name of the course | Value Added / Short Term course on AUTOCAD |
| Course Contents | ➤ Enclosed |
| Course Outcomes | <ul style="list-style-type: none">➤ Evaluate mechanical designs and select the proper process and materials for production.➤ Create 2D and 3D computer drawings and models for manufacturing and prototyping.➤ Evaluate computer aided design models and assemblies based on critical thinking and problem solving skills.➤ Collaborate with people of diverse backgrounds and abilities.➤ Develop a solution through group work.➤ Communicate and present ideas and solutions to design problems. |
| Program Outcomes & Program Specific Outcomes | PO1,PO3,PO4,PO5,PO6,PO9,P10,PO12, PSO2 |
| Course Convener | Dr.P.Murugesan,HoD/MECH |
| Course Coordinators | Mr.S.Ponnusamy AP/MECH |
| Resource Persons | Mr.A.Premkumar AP/MECH Mr.S.Rahul AP/MECH Mr.A.Mohanraj AP/MECH Mr.P.Manikandan AP/MECH |
| Duration & Dates | 38 Hours & 15/06/20 to 19/06/20 |
| Participants & Strength | II YEAR MECH KSRIET STUDENTS & 37 |

Coordinator

Convener

Dr. M. VENKATESAN, M.E., Ph.D.,
PRINCIPAL,
K S R INSTITUTE FOR
ENGINEERING AND TECHNOLOGY,
K.S.R. KALVI NAGAR,
TIRUCHENGODE-637 215,
NAMAKKAL Dt, TAMIL NADU.

K S R INSTITUTE FOR ENGINEERING AND TECHNOLOGY



Tiruchengode - 637215

**(Approved by AICTE, New Delhi and Affiliated by Anna University,
Chennai)**

Department of Mechanical Engineering

Organizes

Value Added Course On AUTOCAD

ACADEMIC YEAR 2020-21

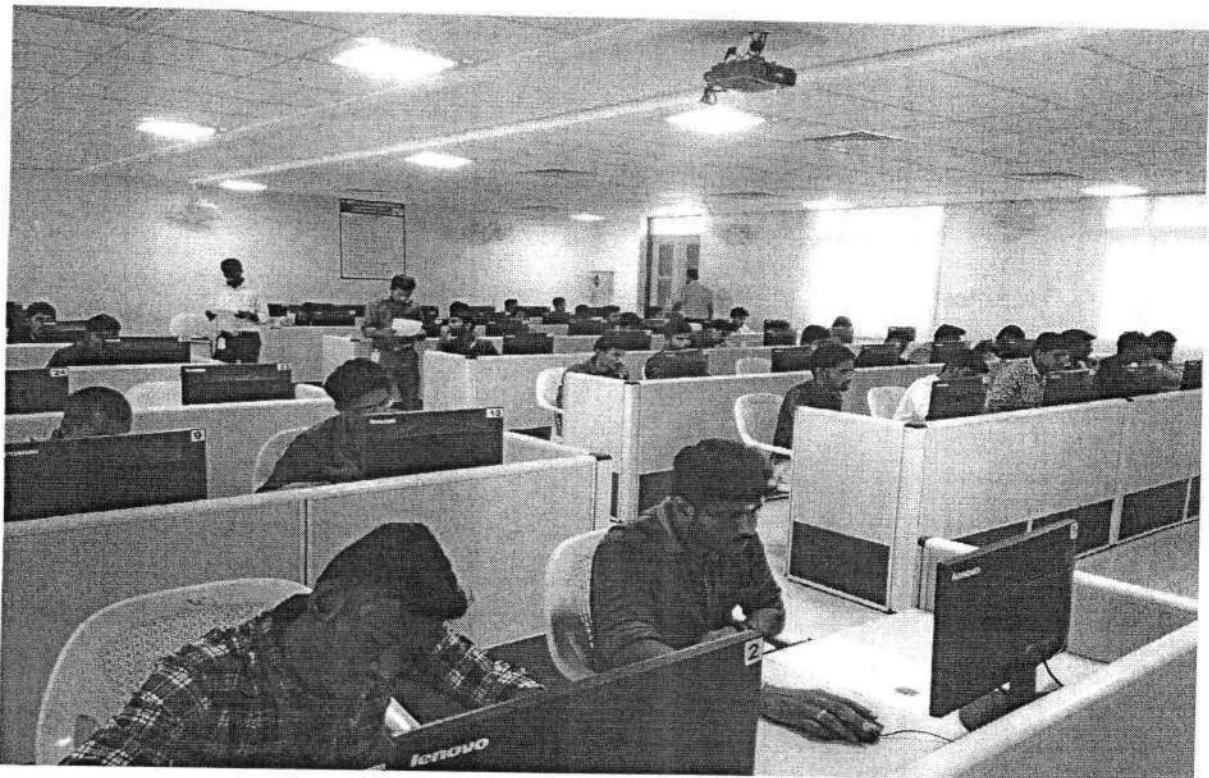

**Dr. M. VENKATESAN, M.E., Ph.D.,
PRINCIPAL,
K S R INSTITUTE FOR
ENGINEERING AND TECHNOLOGY,
K.S.R. KALVI NAGAR,
TIRUCHENGODE-637 215,
NAMAKKAL Dt, TAMIL NADU.**



K S R INSTITUTE FOR ENGINEERING & TECHNOLOGY, TIRUCHENGODE

(APPROVED BY AICTE, NEW DELHI, ACCREDITED BY NBA AND AFFILIATED TO ANNA UNIVERSITY, CHENNAI)

DEPARTMENT OF MECHANICAL ENGINEERING CENTRE FOR VALUE ADDED EDUCATION (CENVAE)

VALUE ADDED COURSE AUTOCAD

CERTIFICATE OF PARTICIPATION



This is to certify that Mr. /Ms. V. DIVESH of 1st year
Department of Mechanical Engineering, K S R INSTITUTE FOR
ENGINEERING AND TECHNOLOGY has attended value added course on
"AUTOCAD" organized by the Department of Mechanical Engineering,
K S R IET from 15/06/20 to 19/06/20.

A. Prasad
21/6/20
COURSE COORDINATOR

Prasad
21/6/20
HOD

P. Venkatesan
21/6/20
IQAC COORDINATOR

M. V. S. A.
PRINCIPAL

ENGINEERING AND TECHNOLOGY,
K.S.R. KALVI NAGAR,
TIRUCHENGODE-637 215,
NAMAKKAL Dt, TAMIL NADU



Value Added Course – Syllabus

The course covers the topics you need to review for the CREO For Industrial Design including:

Module 1: INTRODUCTION TO CREO PARAMETRIC

7

Introduction to Creo Parametric Feature-Based Nature Bidirectional Associative Property Parametric Nature System Requirements Getting Started with Creo Parametric- Important Terms and Definitions File Menu Options- Managing Files- Menu Manager Model Tree -Understanding the Functions of the Mouse Buttons- Ribbon Toolbars Navigator

Module 2: CREATING SKETCHES IN THE SKETCH MODE

8

The Sketcher Environment-Working with a Sketch in the Sketch Mode-Drawing a Sketch Using tools available in the Sketch Tab-Dimensioning the Sketch-Dimensioning the Basic Sketched Entities-Working with Constraints-Resolve Sketch Dialog Box- Deleting the Sketched Entities - Trimming the Sketched Entities- Mirroring the Sketched Entities.

Module 3: OPTIONS AIDING CONSTRUCTION OF PARTS

8

Options Aiding Construction of Parts-Creating Holes-Creating Rounds-Creating Chamfers- Understanding Ribs-Editing Features of a Model-Creating Feature Patterns-Copying Features- Mirroring a Geometry-Creating a Section of a Solid Model

Module 4: ASSEMBLY MODELING

9

Assembly Modelling -Important Terms Related to the Assembly Mode-Creating Top-down Assemblies-Creating Bottom-up Assemblies-Assembling Components-Modifying the Components of an Assembly-Creating the Exploded State

Module 5: SURFACE MODELING

10

Surface Modelling-Creating Surfaces in Creo Parametric-Creating Surfaces the Using the Style Environment of Creo Parametric-Surface Editing Tools Mirroring-Freestyle modelling environment- Invoking the Sheet metal Mode-Introduction to Sheet metal Walls-Creating the Bend Feature Creating the Unbend Feature

Total Period: 42

COORDINATOR

Dr. M. VENKATESAN, M.E., Ph.D.,
PRINCIPAL,
K S R INSTITUTE FOR
ENGINEERING AND TECHNOLOGY,
K.S.R. KALVI NAGAR,
TIRUCHENGODE-637 215,
NAMAKKAL DT, TAMIL NADU.



K S R INSTITUTE FOR ENGINEERING AND TECHNOLOGY
Tiruchengode, Namakkal – 637215
(Accredited by NBA, Affiliated to Anna University, Chennai)

Department of Mechanical Engineering

Value Added Course – Creo for Industrial Design

Schedule

Date: 01/06/2020

| S.No. | Date | Topic | Name of the Faculty |
|-------|----------|--|---|
| 1. | 08/06/20 | Introduction to Creo Parametric Feature-Based Nature Bidirectional Associative Property Parametric Nature System Requirements Getting Started with Creo Parametric- Important Terms and Definitions File Menu Options- Managing Files- Menu Manager Model Tree -Understanding the Functions of the Mouse Buttons- Ribbon Toolbars Navigator | Dr.P.Gopinath Mr.R.Vasanthakumar |
| 2. | 09/06/20 | The Sketcher Environment-Working with a Sketch in the Sketch Mode-Drawing a Sketch Using tools available in the Sketch Tab-Dimensioning the Sketch-Dimensioning the Basic Sketched Entities-Working with Constraints-Resolve Sketch Dialog Box-Deleting the Sketched Entities -Trimming the Sketched Entities-Mirroring the Sketched Entities. | Mr.S.Balamurugan Mr.S.Ponnusamy |
| 3. | 10/06/20 | Options Aiding Construction of Parts-Creating Holes-Creating Rounds-Creating Chamfers-Understanding Ribs-Editing Features of a Model-Creating Feature Patterns-Copying Features-Mirroring a Geometry-Creating a Section of a Solid Model | Dr.P.Murugesan |
| 4. | 11/06/20 | Assembly Modelling -Important Terms Related to the Assembly Mode-Creating Top-down Assemblies-Creating Bottom-up Assemblies-Assembling Components-Modifying the Components of an Assembly-Creating the Exploded State | Mr.S.Mohanavelan Mr.K.Gopalakrishnan |
| 5. | 12/06/20 | Surface Modelling-Creating Surfaces in Creo Parametric-Creating Surfaces the Using the Style Environment of Creo Parametric-Surface Editing Tools Mirroring-Freestyle modelling environment-Invoking the Sheet metal Mode-Introduction to Sheet metal Walls-Creating the Bend Feature Creating the Unbend Feature | Dr.P.Gopinath Mr.R.Vasanthakumar |

Faculty Incharge

Dr. M. VENKATESAN, M.E., Ph.D.,
 PRINCIPAL,
 K S R INSTITUTE FOR
 ENGINEERING AND TECHNOLOGY,
 K.S.R. KALVI NAGAR,
 TIRUCHENGODE-637 215,
 NAMAKKAL Dt, TAMIL NADU.











HOD

K S R Institute for Engineering and Technology
Department of Mechanical Engineering
Value Added Course on Creo Industrial Desgin

Year:III

Attendance Mark

Academic Year:2020-21

| S.NO | REG.NO | NAME OF THE STUDENT | 08.06.20 | 09.06.20 | 10.06.20 | 11.06.20 | 12.06.20 |
|--------------------|--------------|---------------------|---|--|---|---|---|
| 1 | 731618114001 | ARIHARAN M | P | P | P | P | P |
| 2 | 731618114002 | ARIVAZHAHAN R | P | P | P | P | P |
| 3 | 731618114003 | ARULBHARATHI G V | P | P | P | AB | AB |
| 4 | 731618114004 | ARUN PRAKASH K A | AB | P | P | P | P |
| 5 | 731618114005 | BOOBALAN S | P | P | P | P | P |
| 6 | 731618114006 | CHANDRU K | P | P | P | P | P |
| 7 | 731618114007 | DHANASEKAR D | P | P | P | P | P |
| 8 | 731618114008 | DHARANEESHWARAN N | P | P | P | P | P |
| 9 | 731618114010 | GOPINATH S | P | P | AB | P | P |
| 10 | 731618114011 | GOWTHAM K | P | P | P | P | P |
| 11 | 731618114012 | JAYAPRAKASH S | P | P | P | P | P |
| 12 | 731618114013 | KARTHICK RAJA V | AB | P | P | P | P |
| 13 | 731618114014 | KAVIN S | P | P | P | P | P |
| 14 | 731618114015 | KAVIN KUMAR S | P | P | P | P | P |
| 15 | 731618114016 | KAVIRAJ G | P | P | P | P | P |
| 16 | 731618114017 | KRISHNAKUMAR R | P | P | P | P | P |
| 17 | 731618114018 | KRISHNAN S | P | P | P | AB | P |
| 18 | 731618114019 | MANIKANDAN P | P | P | P | P | P |
| 19 | 731618114020 | MANIVASAGAM M | P | P | P | P | P |
| 20 | 731618114021 | MONISHVARAN T | P | P | P | P | P |
| 21 | 731618114022 | PRASANATH S | P | P | P | P | P |
| 22 | 731618114023 | PRAVEEN M | P | AB | P | P | P |
| 23 | 731618114024 | RAJASEKAR S | P | P | P | P | P |
| 24 | 731618114025 | RAMKUMAR S | P | P | P | P | P |
| 25 | 731618114026 | SAMRAT G | P | P | P | P | P |
| 26 | 731618114027 | SARAN K | P | P | P | P | P |
| 27 | 731618114028 | SELVARAJ K | P | P | P | P | P |
| 28 | 731618114029 | SRIDHAR P | P | P | P | P | P |
| 29 | 731618114030 | SRINATH S | P | P | P | P | P |
| 30 | 731618114031 | SUDARSHAN R | P | P | P | P | P |
| 31 | 731618114032 | VENKATESH P | P | P | P | P | P |
| 32 | 731618114033 | VIGNESH G | AB | P | P | P | P |
| 33 | 731618114034 | VIJAY S | P | P | P | P | P |
| 34 | 731618114035 | VIKRAM S | P | P | P | P | AB |
| 35 | 731618114036 | YOGESH G | P | P | P | P | P |
| Course Coordinator | | |  |  |  |  |  |
| HoD | | |  |  |  |  |  |

Dr. M. VENKATESAN, M.E., Ph.D.,
PRINCIPAL,
K S R INSTITUTE FOR
ENGINEERING AND TECHNOLOGY,
K.S.R. KALVI NAGAR,
TIRUCHENGODE-637 215,
NAMAKKAL Dt, TAMIL NADU.

**KSR INSTITUTE FOR ENGINEERING AND TECHNOLOGY
DEPARTMENT OF MECHANICAL ENGINEERING**

Centre of value added education
Assessment Test
CREO FOR INDUSTRIAL DESIGN

Date: 12/06/20
Mark =50

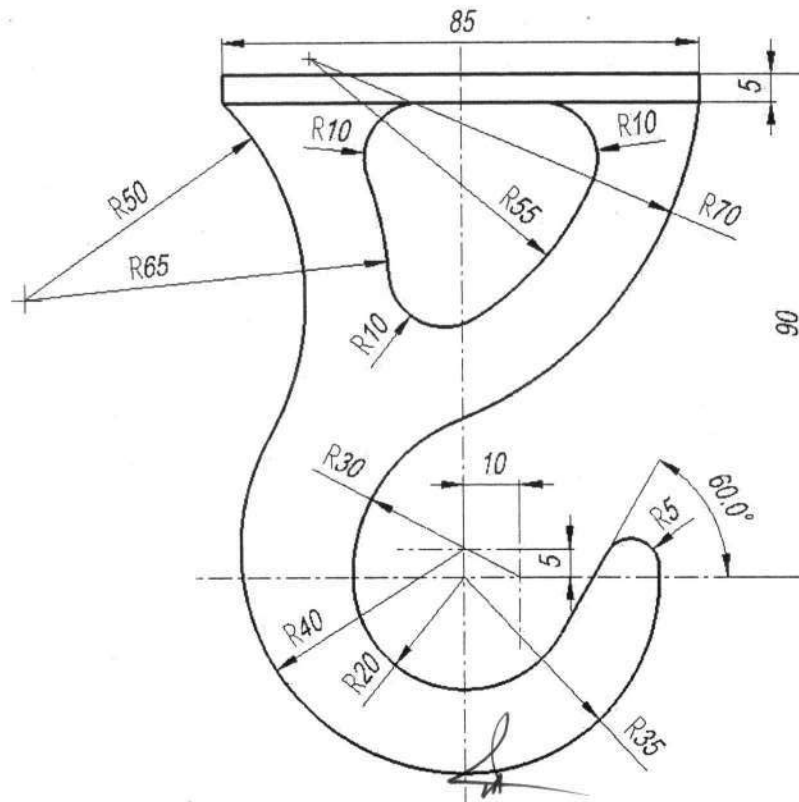

ALL DIMENSIONS ARE IN MM

Course Coordinator

Dr. M. VENKATESAN, M.E., Ph.D.,
PRINCIPAL,
K S R INSTITUTE FOR
ENGINEERING AND TECHNOLOGY,
K.S.R. KALVI NAGAR,
TIRUCHENGODE-637 215,
NAMAKKAL DISTRICT, TAMIL NADU.



HOD

K S R Institute for Engineering and Technology
Department of Mechanical Engineering
Value Added Course on Creo Industrial Desgin

Year:III

Assessment Mark

Academic Year:2020-21

| S.NO | REG.NO | NAME OF THE STUDENT | Marks(50) |
|---------------------------|--------------|---------------------|---|
| 1 | 731618114001 | ARIHARAN M | 36 |
| 2 | 731618114002 | ARIVAZHAHAN R | 39 |
| 3 | 731618114003 | ARULBHARATHI G V | 40 |
| 4 | 731618114004 | ARUN PRAKASH KA | 41 |
| 5 | 731618114005 | BOOBALAN S | 40 |
| 6 | 731618114006 | CHANDRU K | 34 |
| 7 | 731618114007 | DHANASEKAR D | 42 |
| 8 | 731618114008 | DHARANEESHWARAN N | 40 |
| 9 | 731618114010 | GOPINATH S | 35 |
| 10 | 731618114011 | GOWTHAM K | 45 |
| 11 | 731618114012 | JAYAPRAKASH S | 42 |
| 12 | 731618114013 | KARTHICK RAJA V | 42 |
| 13 | 731618114014 | KAVIN S | 41 |
| 14 | 731618114015 | KAVIN KUMAR S | 41 |
| 15 | 731618114016 | KAVIRAJ G | 42 |
| 16 | 731618114017 | KRISHNAKUMAR R | 42 |
| 17 | 731618114018 | KRISHNAN S | 33 |
| 18 | 731618114019 | MANIKANDAN P | 40 |
| 19 | 731618114020 | MANIVASAGAM M | 39 |
| 20 | 731618114021 | MONISHVARAN T | 39 |
| 21 | 731618114022 | PRASANTH S | 45 |
| 22 | 731618114023 | PRAVEEN M | 42 |
| 23 | 731618114024 | RAJASEKAR S | 41 |
| 24 | 731618114025 | RAMKUMAR S | 43 |
| 25 | 731618114026 | SAMRAT G | 45 |
| 26 | 731618114027 | SARAN K | 34 |
| 27 | 731618114028 | SELVARAJ K | 42 |
| 28 | 731618114029 | SRIDHAR P | 45 |
| 29 | 731618114030 | SRINATH S | 33 |
| 30 | 731618114031 | SUDARSHAN R | 45 |
| 31 | 731618114032 | VENKATESH P | 41 |
| 32 | 731618114033 | VIGNESH G | 43 |
| 33 | 731618114034 | VIJAY S | 44 |
| 34 | 731618114035 | VIKRAM S | 38 |
| 35 | 731618114036 | YOGESH G | 42 |
| Course Coordinator | | |  |
| HoD | | |  |

Dr. M. VENKATESAN, M.E., Ph.D.,
PRINCIPAL,
K S R INSTITUTE FOR
ENGINEERING AND TECHNOLOGY,
K.S.R. KALVI NAGAR,
TIRUCHENGODE-637 215,
NAMAKKAL Dt, TAMIL NADU.



K S R INSTITUTE FOR ENGINEERING AND TECHNOLOGY

Tiruchengode, Namakkal – 637 215

(Accredited by NBA, Affiliated to Anna University, Chennai)

DEPARTMENT OF MECHANICAL ENGINEERING

Academic Year: 2020-21

Value Added Course on **“CERO FOR INDUSTRIAL DESIGN”**

Duration:

CONSOLIDATED FEEDBACK FORM

| Parameter | Excellent | Very Good | Good | Satisfactory |
|------------------------|-----------|-----------|------|--------------|
| Content | 18 | 11 | 5 | 1 |
| Clarity of Explanation | 17 | 13 | 3 | 2 |
| Interactive Teaching | 19 | 11 | 3 | 2 |
| Doubt Clarification | 20 | 13 | 3 | 1 |
| Program Management | 15 | 12 | 6 | 2 |



[Signature]
Course Co-ordinator

[Signature]
Dr. M. VENKATESAN, M.E., Ph.D.,
PRINCIPAL,
K S R INSTITUTE FOR
ENGINEERING AND TECHNOLOGY,
K.S.R. KALVI NAGAR,
TIRUCHENGODE-637 215,
NAMAKKAL Dt, TAMIL NADU.

[Signature]
HoD

K S R INSTITUTE FOR ENGINEERING AND TECHNOLOGY

TIRUCHENGODE – 637 215

DEPARTMENT OF MECHANICAL ENGINEERING

VALUE ADDED / SHORT TERM COURSE – SUMMARY

Academic Year: 2020-21 (ODD)

| | |
|---|--|
| Name of the course | Five days Value Added / Short Term course on Creo for Industrial Design |
| Course Contents | ➤ Enclosed |
| Course Outcomes | <ul style="list-style-type: none">• Students will learn how to sketch, model, validate design and visualize product design using the software• Students will be able to do direct drafting, direct modelling and parametric 3D modelling.• Students will know how to validate your product design according to the given requirement.• This is a Ready-for-Industry course which gives the students ample knowledge to ace the placement drive. |
| Program Outcomes & Program Specific Outcomes | PO1,PO3,PO4,PO5,PO6,PO9,P10,PO12,PSO2 |
| Course Convener | Dr.P.MURUGESAN, HoD/MECH |
| Course Coordinators | Mr.S.Ponnusamy AP/MECH |
| Resource Persons | Dr.P.Gopinath Mr.R.Vasanthakumar Mr.S.Balamurugan Mr.S.Ponnusamy |
| Duration & Dates | Five days (42 Hours) & 08/06/20 to 12/06/20 |
| Participants & Strength | III YEAR MECH KSRIET STUDENTS & 38 |

Coordinator



Convener

Dr..M. VENKATESAN, M.E., Ph.D.,
PRINCIPAL,
K S R INSTITUTE FOR
ENGINEERING AND TECHNOLOGY,
K.S.R. KALVI NAGAR,
TIRUCHENGODE-637 215,
NAMAKKAL Dt, TAMIL NADU.



K S R INSTITUTE FOR ENGINEERING AND TECHNOLOGY

Tiruchengode, Namakkal – 637215

Department of Mechanical Engineering

**(Approved by AICTE, New Delhi and Affiliated by Anna University,
Chennai)**

Value Added Course

ACADAMIC YEAR CREO FOR INDUSTRIAL DESIGN

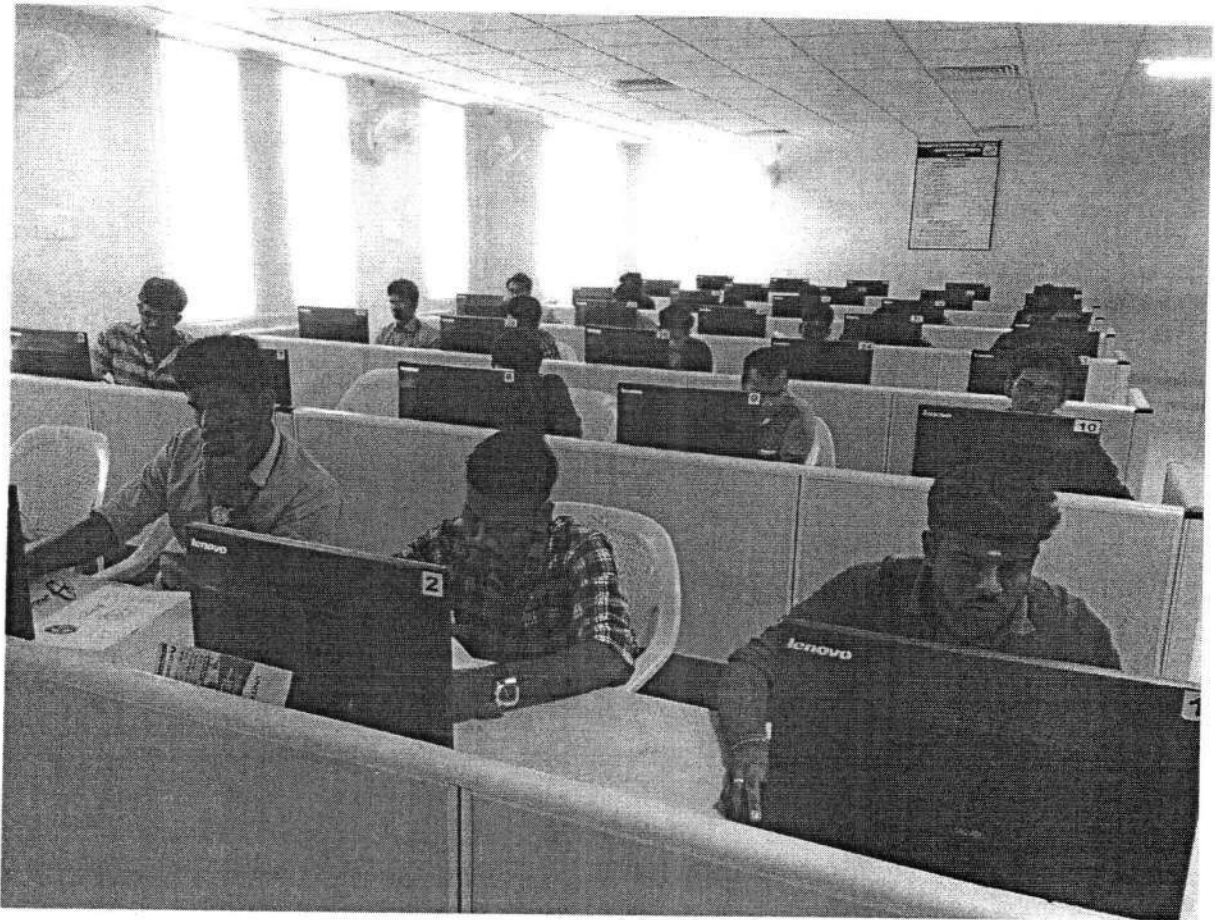

Dr. M. VENKATESAN, M.E., Ph.D.,
PRINCIPAL,
K S R INSTITUTE FOR
ENGINEERING AND TECHNOLOGY,
K.S.R. KALVI NAGAR,
TIRUCHENGODE-637 215,
NAMAKKAL DI, TAMIL NADU.

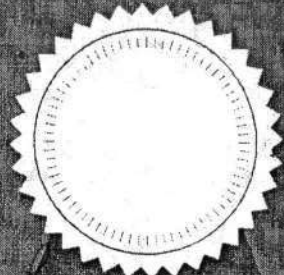

K S R INSTITUTE FOR ENGINEERING & TECHNOLOGY

(APPROVED BY AICTE, NEW DELHI AND AFFILIATED TO ANNA UNIVERSITY, CHENNAI)

DEPARTMENT OF MECHANICAL ENGINEERING

CENTRE FOR VALUE ADDED EDUCATION (CENVAE)

VALUE ADDED COURSE CREO FOR INDUSTRIAL DESIGN

Certificate of Participation

This is to certify that Mr. /Ms. J. ARUN
of III year, Department of Mechanical Engineering,
K S R INSTITUTE FOR ENGINEERING AND TECHNOLOGY
has attended a Five days value added course on "Creo
for Industrial Design" organized by the Department of
Mechanical Engineering, KSR IET from 08.06.2020 to
12.06.2020.

Dr. Umapathi
15/6/20

COURSE COORDINATOR

P. V. V. V.
15/6/20

HOD

P. Veer
15/6/20

IQAC COORDINATOR

M. V. R.

PRINCIPAL